

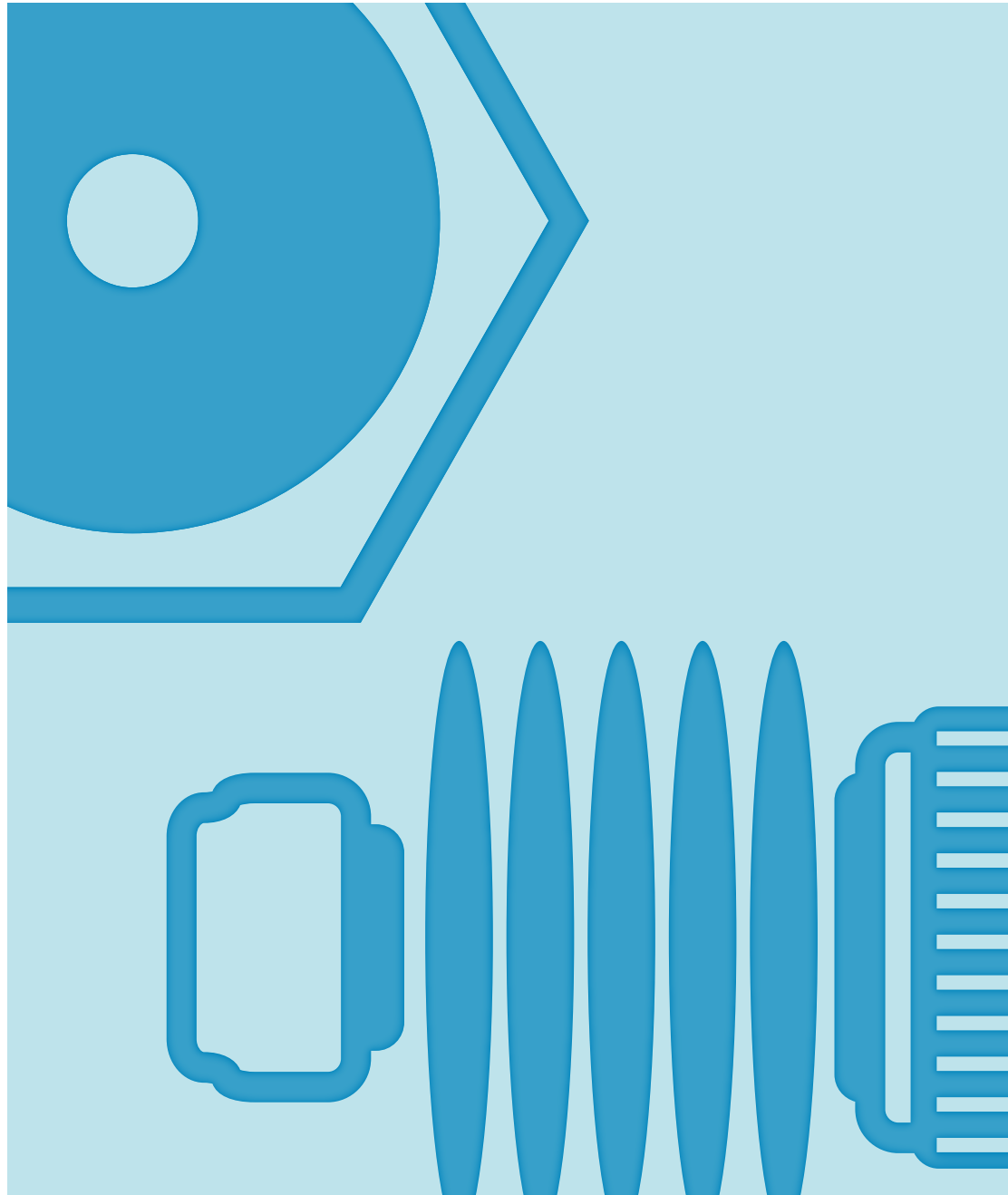

RF COAXIAL
CONNECTORS



MICROWAVE
COMPONENTS



Coaxial, RF & Microwave

Full Line Catalog



Australian Representatives
ROJONE, PTY LTD.
Tel: 02 9829 1555
E: sales@rojone.com.au
www.rojone.com.au



Connectivity has a profound and dramatic impact on the lives of people throughout the world. Because of advancements in technology, **our** lives are more convenient, more secure, more enjoyable and richer than ever. The speed of data enables communication in the **most** remote areas so people can reach all corners of the globe, allows for **important** defense and security, and facilitates space exploration. But technology doesn't just happen. It starts in the mind with ideas, making **connections** never considered in ways that nobody dreamed possible. Seeing the future in ways previously unimagined **is** the act of innovation and it begins with people—the inventors, the dreamers, the pioneers and the engineers—enriching the lives of billions. At Radiall, we have one single, solitary mission; Empower the people that enrich our lives. Enable their innovation by providing reliability and durability. Give them useful information and provide them with valuable guidance when determining the best course for success. We don't invent the future, we enable it. We inspire innovation, we embrace challenges, we challenge the conventional and we collaborate **with** you to succeed. At Radiall, we're proud to say – Our most important connection is with **you**.

MCX / MMCX / MMS / MMT / MML series R113 / R110 / R209 / R210 / R302	1
SMPM / SMP / SMP-LOCK™ / SMP-COM series R201 / R222 / R222L / R2229	2
Board-to-Board: MMBX / SMP-MAX series R223 / R222M	3
Coaxipack 2 series R694	4
Switching Connectors / Moebius / MC-Card / RP-MCX series R199 / R299	5
SMB / SMB Lock / SMC series R114 / R117 / R112	6
SMA / SMA-COM / BMA series R125 / R124 / R128	7
Quick-Lock : QMA / WQMA / QN / QRE™ series R123 / R123W / R164 / R324	8
BNC / BNC 75 HDTV / BNC-TRX series R141 / R142 / R266	9
High Frequency Connectors: N 18 GHz / TNC 18 GHz / SMA 2.9 / 2.4 mm series R163 / R143/ R127 / R327	10
N / TNC / C series R161 / R162 / R143 / R144 / R166	11
SSMA / SSMB / SSMC series R121 / R203 / R202	12
4.1-9.5 / 4.3-10 / QLI / 7/16 series R170 / R183 / R184 / R185	13
Miscellaneous: BR2 / UHF / IMP / UMP / Type 43 series R605 / R155 / R107 / R214	14
High Voltage Connectors (BNC HT-MHV/ SHV / THT 20 / HN) / Non-Magnetic Connectors R316 / R317 / R331 / R176	15
Adapters R191 / R192	16
Tooling & Accessories R280 / R282	17
Coaxial Cable Assemblies C291	18
Microwave Components R404 / R41x	19
Banana Plugs R644 / R921 / R929 / R941 / R948 / R995 / R999	20
INDEX	21

Company Profile

Our Most Important Connection is with You™

Radiall is a global leader in the design, development and manufacturing of leading edge interconnect solutions. Dedicated to understanding its customers' needs since 1952, Radiall has earned the reputation of being "the best of the best" in engineering ingenuity by providing a constant flow of creative system solutions serving the defense, telecommunications, aerospace, instrumentation, automotive, industrial, medical and broadcast markets.

Best Value-added Services

Collaboration: We work closely with your engineers to understand your business, your technical needs, and your budgetary requirements.

Wide Product Range: We manage our product lines through the entire lifecycle in order to offer you a wide selection of standard products at an affordable cost.

Custom Products: We can tailor products to specific equipment and application needs.

Global Presence: We're everywhere you need us, with worldwide sales, engineering support, R&D in North America, Europe, and Asia, and manufacturing facilities strategically located in the United States, Mexico, France, India, and China.

Responsive Support and Service: From the design stage, to planning and post-installation support, we're with you at every step, whether you need sales support or engineering expertise.

On-time Delivery: We support your logistical needs so you get the products when and where you need them.

Warranty: We proudly stand behind our products.

Certifications and Environmental

Radiall is ISO 9001: 2008 certified and dedicated to continuous improvement programs that have resulted in also being AS9100, TS16949 and ISO 14001 certified. In addition, Radiall is committed to investing in its people, future technologies and the environment, such as being RoHS (Restriction of Hazardous Substances) and REACH (Registration, Evaluation, Authorization and Restriction of Chemical substances) compliant.



The Best End-to-End Interconnect Solutions

We offer an extensive range of solutions that supports the most demanding signal transmission applications. 4G wireless infrastructure, active array radars, IED's detection, electrical wiring in aircrafts, soldier tactical radios, in-vehicle communications networks, and magnetic resonance imaging systems are just a few of the complex applications that we support.

- RF coaxial connectors
- Fiber optic connectors and transceivers
- Coaxial and fiber optic cable assemblies and harnesses
- High frequency microwave components
- Coaxial switches, including the smallest and most reliable SPDT relay
- Multipin rectangular connectors
- Rack and panel connectors
- Antennas for tactical networks, aerospace and instrumentation



Visit www.radiall.com for technical information and sales contacts

Radiall at a Glance

Worldwide Presence

Radiall has a global manufacturing presence. Our International sales network and qualified distributors cover every region around the world. The result is quick and insightful answers to all your requests.

- International sales network
- Low cost facilities
- Local manufacturing, logistics and technical support



North America



Asia



Europe



Market Focus

Aerospace



Defense



Industrial



Space



Telecom



Instrumentation



Medical



Radiall Technologies

- Milling
- Plating & plastic metallization
- Molding
- Characterization
- Polishing
- Laser, ultrasonic, vapor, soldering
- Stamping
- Thin & thick film processes
- Etching on Si
- Thick film on AlN
- Test & measurement
- Simulation
- Cable & PTFE wrapping
- Automatic assembly
- Micro-machining



A Global Range to Meet Your Needs



RF Coaxial Connectors

Radiall proudly offers the widest range of RF Coaxial Connectors in the Industry with over 13,000 part numbers and 55 product series including AEP® Mil QPL connectors. These precision-made components are a significant part of our heritage and essential to who we are.



RF & Microwave Switches

All Radiall switches provide exceptional reliability and performance. A unique modular and patented design of the actuator and transmission link enables Radiall to guarantee operation up to 10 million cycles with excellent repeatability, while reducing delivery times.



Microwave Components

Radiall has a wide range of coaxial devices, including terminations, attenuators, and couplers using standard interfaces from low to high power. Our state of the art techniques enable us to produce microwave components for use in commercial, military, and space applications.



Antennas

Radiall provides highly reliable antenna solutions for industrial and military applications. Our solutions include Line-Of-Sight tactical communications, vehicular mount, GPS, telemetry, and mesh networks. For optimum performance requirements, Radiall offers custom antenna solutions and support.



Multipin Connectors

Radiall has an unmatched range of rack and panel connectors and the most innovative modular and tool-less connectors used in harnesses and equipment connections. Our modern designs combine light weight, high performance levels and user friendly features to simplify even the most complex connections.



RF Cable Assemblies

Radiall has an extensive range of cable assemblies with outstanding electrical performance, low loss, and high frequency. Our range includes flexible, semi rigid and handformable cable assemblies. Our TestPro™ range meets the stringent requirements needed for test and lab applications.



Space Qualified

Industry leaders across the globe recognize the Radiall brand for quality, reliability, and performance. Our Space Qualified passive product offering includes a wide range of coaxial connectors, cable assemblies, microwave components, and switches with a frequency range up to Ka band.



D-Lightsys®

Active Optical Solutions Optimized by D-Lightsys® for harsh environments. From optical transceivers to the world's smallest parallel optics, D-Lightsys® technologies support the most challenging applications, including harsh environments and avionics applications.



Harnesses

The combination of design and manufacturing of RF and microwave cables as well as multipin connectors (EPX, ARINC 404 and 600) allows Radiall to be a specialist of harnesses for onboard or land equipment or communications systems. All types of contacts can be used and mixed such as signal, power, RF, quadrax, fiber optic...



Fiber Optics

Radiall designs and supports high performance end-to-end Optical Interconnect solutions. Our offer includes standard interfaces, terminations, connectors, harnesses and custom design optical links and subsystems. The flexibility and high quality of our product range supports harsh environments and demanding applications.

Packaging

Shipping information

Unless otherwise stated, shipping lead times may vary depending on the location and time zone in which products are stocked or manufactured. The packaging defines the container of first level of a product. Radiall offers five types of standard packaging.



Labeling

Labeling has an important role in packaging. It has to supply all the necessary information in a clear and concise way. All of our packages are identified with the Radiall name, part number, lot number and quantity.

Blister tray

DEDICATED TO LARGER CONNECTORS • ABILITY TO STACK SEVERAL TRAYS WITHOUT DAMAGING THE CONNECTORS



- This specific packaging is suitable for large or fragile connectors. Products are vertically arranged in custom trays, providing protection against shock and making it easy to quickly count quantity.
- They are covered by an anti-dust lid or wrapped with a plastic film.
- This packaging is available for specific types of connectors when standard packaging might cause damage during shipping.

Tape and reel



- Products are arranged in an anti-static polyester blister tape covered with a ribbon defender. The set is then rolled up on a polyester reel which can receive 100, 500, 1800 or 3000 parts depending on the model.
- This packaging, dedicated to surface mount components is compatible with all pick and place automatic machines. It is CEI 286-3 compliant.

Bulk

BULK BAG OR BOX OF 100 PIECES (CONNECTOR BODY + CENTER FERRULE + CENTER CONTACT)



- The multiple bag or box contains 20, 50, or 100 of each component part in separate bags.

Packaging

Unit packaging

- All connectors can be ordered in unit bags. It is an individual tear-proof polyethylene bag, which holds the connector and all of the component parts for that connector.
- Unit packaging must be specified when ordering: add « W » at the end of the part number (except for adapters and specific products).

Pre-cut unit bag (no cutting tool required to open)



Blister bulk pack

FOR MULTI-PART PRODUCTS • EASY TO OPEN • IDEAL FOR IN-THE-FIELD ASSEMBLY

- This bulk packaging is suitable for small connectors. Radiall offers four types of blister bulk pack depending on the configuration of the product and the number of pieces (10, 20, 50, or 100).

Three compartments blister bulk pack of 20 pieces



Shipping box

Radiall has designed multiple boxes for optimum packaging and protection. These boxes are available in various optimized sizes.

- Eco friendly design labeled tape makes it easy to identify Radiall goods. Printing is minimized in order to limit the use of toxic substances. All boxes can be recycled (except for the adhesive).
- Each product part number has a dedicated carton box adapted to the size of its packaging.
- All individual boxes are typically placed in size 20L shipping boxes (40x30x20 cm).

Performance, not promises

AEP Part Numbering System

9006-9113-001

A B C D

A Model number

1000-1999 - SMC
2000-2999 - SMB
3000-3999 - SLB
4000-4999 - N
5000-5999 - Adapters
6000-6499 - TNC
6500-6999 - BNC
7000-7199 - SSMC
7200-7299 - SSMB
7300-7499 - SSLB
8000-8999 - Others
9000-9999 - SMA - SSMA

B Plating

1 - Gold
6 - Silver
7 - Nickel
8 - Tin
9 - Passivated

C Material

1 - Brass
2 - Beryllium copper
3 - Stainless steel
4 - Brass & Stainless steel
6 - Ph bronze
7 - Brass over Ni

D Cable group

01 - RG55, RG142, RG223
02 - RG178, RG196
03 - RG174, RG188, RG316
05 - RD196, RD178
06 - RG58, RG141
07 - RG59, RG62
08 - RD188, RD316, RD 174
09 - .141, RG402
10 - .085, RG405
11 - .047
12 - .250, RG401
25 - RD178
30 - RG122



Applied Engineering Products (AEP) was established in 1972 as a company which strongly believes in quality products and on-time delivery. A custom-built facility established in the downtown area of New Haven CT, USA was home to this highly successful company, which ranked as the best of the US independent manufacturers of sub-miniature coaxial connectors used in the RF and Microwave Industry.

Today, AEP is a Radiall product brand commercialized alongside the core Radiall RF product lines. AEP connectors and cable assemblies are designed and qualified by our dedicated staff in New Haven, CT. The most popular AEP product range is the "7000" family, which includes multiple designs in SSMB, SSMC and SSLB connector series. AEP is also recognized for the reliability of its waterproof coaxial connectors, 100% immersion tested before shipping. With over 100 AEP QPL MIL-PRF-39012 active part numbers, Radiall is well positioned to serve the needs of the military and defense radio equipment manufacturers.

In this catalog, AEP connector part numbers are listed together with the Radiall line. The AEP codification for connectors is explained below. Most AEP connector data sheets are available for download at www.radiall.com. Click on "Product Finder", then "RF Coaxial Connectors" and select AEP.

Ingress Protection Rating

First digit (protection against solid objects)



0 - No protection



1 - Protected against solid objects over 50mm (e.g. accidental touch by hands)



2 - Protected against solid objects over 12mm (e.g. Fingers)



3 - Protected against solid objects over 2.5mm (e.g. tools and wires)



4 - Protected against solid objects over 1mm (E.g. tools, wires and small wires)



5 - Protected against dust - limited ingress (No harmful deposit)



6 - Totally protected against dust

Second digit (protection against liquids)



0 - No protection



1 - Protected against vertically falling drops of water



2 - Protected against direct sprays up to 15° from the vertical



3 - Protected against direct sprays up to 60° from the vertical



4 - Protected against sprays from all directions limited ingress permitted



5 - Protected against low pressure jets of water from all directions - limited ingress permitted



6 - Protected against strong jets of water (e.g. for use on shipdecks) - limited ingress permitted



7 - Protected against the effects of temporary immersion 15cm to 1m. Duration of test: 30 min.



8 - Protected against long periods of immersion under pressure

Ingress Protection Rating

The rating number refers to a specific test described by international standard (IEC60529 for example) specifying and classifying the degree of protection from dust and water for the equipment.

The first digit represents the protection level against solid object and the second against liquids.

Example on our N clamp type connector: IP67= totally protected against dust and against temporary immersion between 15cm and 1m.

Note

Do not mix up IP rating with hermeticity level.

Hermeticity sealing is required for microwave modules to provide long term reliability.

A measure of hermeticity is the leak rate, which is expressed in atmosphere cc/second, based on the Helium Fine Leak Test (MIL-std 803 or JEDIC - JESD22-A109-A).

A traditional hermeticity value must be 5×10^{-8} atm-cc/s Helium or better.

Plating Properties

Radiall offers a comprehensive range of in-house electroplating for standard or specific uses and conditions. Plating performance is key in several characteristics of the connector such as: Durability, Wear Behavior, Contact Resistance, Electrical Conductivity, Magnetic Properties, Corrosion Behavior, Solderability, and Appearance. Radiall operates its plating facility since 1977 in compliance with the latest environmental standards.

Radiall Plating Know-How

Available coatings are Copper, Nickel, Nickel phosphorous, Tin, Gold, Palladium, white Bronze, Chromium, Silver, Nickel PTFE, and passivation of stainless steel. Base materials on which we apply coating are Copper alloys, Stainless steel, Ferronickel, Zink die cast, Plastic, and Aluminium.



Radiall Proprietary Plating

NPGR (Nickel Phosphorous Gold Radiall)

This plating consists of a thin layer of gold on top of a layer of electrolytic nickel-phosphorous. With the addition of Phosphorous (>10%), the Ni becomes non magnetic and offers a low intermodulation level. The combination of gold and NiP provides an excellent protection against corrosion, and an ultra low friction coefficient allowing up to 10,000 mating cycles. The thin gold layer allows for good wetability. NPGR is recommended for center and outer contacts, PCB/SMT connector bodies, and for telecom/datacom applications. It is not recommended, however, for solder joints in harsh environment, high temperature applications. NPGR is a cost reduction alternative to standard gold plating compliant with AMS QQN 290 and MiL DTL 45204.

N2PGR (New Nickel Phosphorous Gold Radiall)

This plating offers similar properties as NPGR with the following advantages: improved mechanical resistance and reliability of solder joints in high temperature environment and better corrosion resistance. This is achieved due to a new Nickel barrier between NiP and gold. N2PGR is compliant with AMS QQN 290 and MiL DTL 45204.

BBR (Bright Bronze Radiall)

BBR is a copper-tin-zinc base alloy plating, applicable on all copper substrates which looks like bright white silver. It was designed to replace Ni plating and offers better conductivity while being non allergic and non magnetic. Intermodulation generated by BBR is as low as that with silver plating. BBR connectors are solderable using mildly activated flux. Corrosion and tarnishing resistance are among the most important environmental features of this plating, together with excellent wearing resistance and mechanical characteristics. BBR is recommended for outer contacts and conductor bodies in cable and panel connectors' applications.

Standard Plating

Gold

Gold plating is preferred for its great electrical signal transmission properties. It also provides excellent oxidation resistance (even in polluted environment) and mating durability (wear resistant). Gold over copper is mainly used for center and outer contacts with thickness of 0.8 to 2.5µm or more. Gold over Nickel is often used for PCB connector bodies to improve solderability. Gold is compliant with MiL DTL 45204.

Nickel

This plating has been widely used on connector bodies and outer conductors for its mechanical and environmental properties. But it is often replaced by alternative platings because of the risk of allergy. Now Nickel is commonly used as an underlayer for gold or other noble metals. The Ni layer acts as a diffusion barrier, to prevent the migration of base material atoms (usually copper) to the top coating. But Nickel is magnetic thus not suitable for applications requiring a low IM level. Where Nickel plating is used for PCB connectors with solder legs, it is recommended to choose selective tin plating or hot dipping on the legs before soldering. Nickel is compliant with AMS QQN 290.

Silver

The main advantage of Silver is its excellent electrical and thermal conductivity, featuring the lowest contact resistance. Silver plated connectors are particularly suitable for applications where low intermodulation is required. It is also recommended for connector parts that need soldering or brazing. Silver plating is often used as a cheaper replacement for gold plating, but Silver tarnishes over time, creating an oxide layer on the surface which affects its electrical properties. Silver is often combined with BBR to avoid tarnishing. Silver is compliant with ASTM B700.

Nickel PTFE

Nickel PTFE plating can be specified for connectors used in harsh environment for military applications, due to its friction, corrosion and wear resistance. Nickel PTFE is compliant with AMS 2454.



Manual plating production line



Automatic plating production line

Summary table

	Solderability	Electrical performance	Corrosion resistance	Friction, mating durability	IM, magnetic properties	Hardness	Tarnishing	Cost
NPGR - N2PGR (*)	+	++	++	++	+	+	+	+
BBR	-	+	++	+	++	++	++	++
GBR	+	+	++	+	+	+	+	+
Gold / nickel Ni2Au0.2	+	++	++	+	-	+	+	+
Gold / copper Cu2.5Au1.3	+	++	++	+	+	-	+	--
Silver	+	++	+	-	++	--	--	-
Nickel	-	+	++	+	--	+	++	+
NiPTFE	--	+	+++	+++	--	+++	+++	--

(*) NPGR is not compatible with Zinc die cast (zamak) parts.

RF Cable Assemblies

A. Cable Type

B. Cable Dimensions mm (Inch)

C. Radiall Cable if Applicable

Type	Cable Designation	Cable Group dia. / Ω	Max Freq.	Core Type	Core dia.	Dielectric/ Insulator dia.	Outer dia.	Radiall P/N	Additional Comments
Microcoax & mini coax	N/A	0.8 / 50 S	3 GHz	Solid	0.16 [.006]	0.50 [.020]	0.83 [.033]	C291042066	PFA dielectric
	N/A	1 / 50 S	2 GHz	Solid	0.17 [.007]	0.52 [.020]	1.17 [.046]	C291050060	PTFE dielectric
	50 VMTX Type	1 / 50 S	3 GHz	Solid	0.17 [.007]	0.52 [.020]	1.17 [.046]	C291050066	PTFE dielectric
	N/A	1 / 50 S	6 GHz	7 x 0.08	0.24 [.009]	0.68 [.027]	1.13 [.044]	C291051270	PTFE dielectric
	N/A	1 / 50 S	6 GHz	7 x 0.102	0.30 [.012]	0.89 [.035]	1.37 [.054]	C291066070	PTFE dielectric
	75 VMTX Type	1 / 80 S	2 GHz	Solid	0.10 [.004]	0.57 [.020]	0.80 [.031]	C291055076	PTFE dielectric
	124416 Type	2/50 D	3 GHz	Solid	0.29 [.011]	0.84 [.033]	1.60 [.063]	C291146087	PTFE dielectric
	296775 Type	2/75S	3 GHz	Solid	0.17 [.007]	1.00 [.039]	2.00 [.079]	C291147060	PTFE dielectric
ECO (high performance by Radiall)	ECO 316	2.6 / 50 S	3 GHz	Solid	0.55 [.022]	1.55 [.061]	2.45 [.096]	C291999904	Better than RG316
	ECO 316 X	2.6 / 50 S	3 GHz	Stranded	0.54 [.021]	1.54 [.061]	2.52 [.099]	C291171083	Better T°C & power range
	ECO 316 D	2.6 / 50 D	3 GHz	Solid	0.55 [.022]	1.55 [.061]	2.80 [.110]	C291999905	Better than RD316
	ECO 316 DX	2.6 / 50 D	6 GHz	Stranded	0.54 [.021]	1.54 [.061]	3.16 [.124]	C291217020	Better T°C & power range
	ECO 142	5 / 50 D	3 GHz	Solid	0.95 [.037]	2.80 [.110]	4.50 [.177]	C291325290	Better than RG142
	ECO 142 X	5 / 50 D	6 GHz	Solid	0.95 [.037]	2.98 [.117]	5.00 [.197]	C291320180	Better T°C & power range
	POWER142	5 / 50 D	3 GHz	solid	0.94 [.037]	2.95 [.116]	4.50 [.177]	C291325270	High power level
	ECO 230	6 / 50 D	4 GHz	Solid	1.48 [.057]	4.07 [.160]	5.90 [.232]	C291326490	
	ECO 393	10 / 50 D	3 GHz	Solid	2.40 [.094]	7.25 [.285]	9.10 [.358]	C291491060	Better than RG393
	ECO 393 X	10 / 50 D	6 GHz	7 x 0.8	2.35 [.093]	7.20 [.283]	10 [.394]	C291512020	ECO393 with high power level
Semi-rigid NF-C-93-551	KS 1	.085"	20 GHz	Solid	0.51 [.020]	1.68 [.066]	2.20 [.087]	C291850001	Copper tubing
	KS 2	.141"	20 GHz	Solid	0.92 [.036]	2.98 [.117]	3.58 [.141]	C291860001	Copper tubing
	KS 3	.250"	20 GHz	Solid	1.63 [.064]	5.31 [.209]	6.35 [.250]	C291870001	Copper tubing
Flexible NF-C-93-550 standard	KX 3B	2.6 / 50 S	1 GHz	7 x 0.16	0.48 [.019]	1.52 [.060]	2.79 [.110]	C291150010	PVC jacket
	KX 4	10 / 50 S	3 GHz	7 x 0.75	2.25 [.089]	7.25 [.285]	10.29 [.405]	C291510010	PVC jacket
	KX 6A	6 / 75 S	1 GHz	7 x 0.20	0.60 [.024]	3.70 [.146]	6.10 [.240]	C291351012	PVC jacket
	KX 8	10 / 75 S	1 GHz	7 x 0.40	1.20 [.047]	7.25 [.285]	10.29 [.405]	C291550012	PVC jacket
	KX 13	11 / 50 D	11 GHz	7 x 0.75	2.25 [.089]	7.24 [.285]	10.80 [.425]	C291600000	PVC jacket
	KX 14	22 / 50 S		Solid	5.0 [.197]	17.30 [.681]	22.10 [.870]	N/A	
	KX 15	5 / 50 S	1 GHz	19 x 0.18	0.90 [.035]	2.95 [.116]	4.95 [.195]	C291305010	PVC jacket
	KX 21A	2 / 50 S	3 GHz	7 x 0.10	0.30 [.012]	0.84 [.033]	1.78 [.070]	C291145017	FEP jacket
	KX 22A	2.6 / 50 S	3 GHz	7 x 0.17	0.53 [.021]	1.52 [.060]	2.49 [.098]	C291170017	FEP jacket
	KX 23	5 / 50 D	3 GHz	7 x 0.34	0.92 [.036]	2.95 [.116]	5.10 [.200]	C291322017	Fiber glass jacket
	KX 24	11 / 50 D	11 GHz	7 x 0.80	2.40 [.094]	7.25 [.285]	10.90 [.429]	C291605017	Fiber glass jacket
	KX 25	6 / 75 S		7 x 0.23	0.71 [.028]	3.70 [.146]	5.90 [.232]	N/A	
	KX 30	6 / 93 S		Solid	0.64 [.025]	3.70 [.146]	6.15 [.242]	N/A	
KX 52	6 / 75 S		Solid	0.64 [.025]	3.70 [.146]	6.10 [.240]	N/A		
Standard flexible HD	Mini RG59 Type	4.6 / 75 D	4.5 GHz	Solid	0.60 [.024]	2.80 [.110]	4.60 [.181]	C291033039	
	RG59 Type	6 / 75 D	4.5 GHz	Solid	0.81 [.032]	3.68 [.145]	5.92 [.233]	C291360093	
	RG6 Type	7 / 75 D	4.5 GHz	Solid	1.02 [.04]	4.56 [.18]	6.95 [.274]	C291384083	
LMR®*	LMR 200	5 / 50 S		Solid	1.12 [.044]	2.95 [.116]	4.95 [.195]	C291316070	PE jacket
	LMR 400	10.3 / 50 S		Solid	2.77 [.109]	7.24 [.285]	10.3 [.405]	C291516070	PE jacket
	LMR 600	15.2 / 50 S		Solid	4.47 [.176]	11.56 [.455]	14.99 [.590]	C291626070	PE jacket
AEP (equivalent to LMR®*)	AEP-100FR	2.6 / 50 S+F	6 GHz	Solid	0.46 [.018]	1.52 [.060]	2.79	C291327060	Flame retardant
	AEP-195FR	5 / 50 S+F	6 GHz	Solid	0.94 [.037]	2.79 [.116]	4.95	C291327010	Flame retardant
	AEP-200FR	5 / 50 S+F	6 GHz	Solid	1.12 [.044]	2.95 [.116]	4.95	C291327020	Flame retardant
	AEP-240FR	6.1 / 50 S+F	6 GHz	Solid	1.42 [.056]	3.81 [.15]	6.1	C291327030	Flame retardant
	AEP-400FR	10.3 / 50 S+F	6 GHz	Solid	2.74 [.108]	7.24 [.285]	10.29	C291327040	Flame retardant
	AEP-600FR	15 / 50 S+F	6 GHz	Solid	4.47 [.176]	11.56 [.455]	14.99	C291327050	Flame retardant
Flexible MIL-C-17 standard	RG 6 A/U	8 / 75 D		Solid	0.72 [.028]	4.70 [.185]	8.43 [.332]	N/A	
	RG 11 A/U	10 / 75 S		7 x 0.4	1.20 [.047]	7.25 [.285]	10.29 [.405]	N/A	
	RG 12 A/U	10 / 75 S		7 x 0.4	1.20 [.047]	7.25 [.285]	12.06 [.474]	N/A	
	RG 58 C/U	5 / 50 S	1 GHz	19 x 0.18	0.90 [.035]	2.95 [.116]	4.95 [.195]	C291305000	PVC jacket
	RG 59 B/U	6 / 75 S	1 GHz	Solid	0.57 [.022]	3.71 [.146]	6.15 [.242]	C291360000	PVC jacket
	RG 62 B/U	6 / 93 S	1 GHz	Solid	0.64 [.025]	3.71 [.146]	6.15 [.242]	C291400000	PVC jacket
	RG 63 B/U	10 / 125 S		Solid	0.65 [.026]	2.95 [.116]	10.29 [.405]	N/A	
	RG 71 B/U	6 / 93 D		Solid	0.64 [.025]	3.71 [.146]	6.22 [.245]	N/A	
	RG 140 U	6 / 75 S		Solid	0.64 [.025]	3.71 [.146]	5.92 [.233]	N/A	
	RG 141 A/U	5 / 50 S	1 GHz	Solid	0.99 [.039]	2.95 [.116]	4.83 [.190]	C291315007	Glass fiber jacket

RF Cable Assemblies

A. Cable Type

B. Cable Dimensions mm (Inch)

C. Radial Cable if Applicable

Type	Cable Designation	Cable Group dia. / W	Max Freq.	Core Type	Core dia.	Dielectric/ Insulator dia.	Outer dia.	Radial P/N	Additional Comments	
Flexible MIL-C-17 standard continued	RG 142 B/U	5 / 50 D	12.4GHz	Solid	0.94 (.037)	2.95 (.116)	4.95 (.195)	C291320007		
	RG 144 /U	10 / 75 S		7 x 0.45	1.35 (.053)	7.25 (.285)	10.40 (.409)	N/A		
	RG 165 /U	10 / 50 S		7 x 0.8	2.40 (.094)	7.25 (.285)	10.40 (.409)	N/A		
	RG 174 A/U	2.6 / 50 S	1 GHz	7 x 0.16	0.48 (.019)	1.52 (.060)	2.79 (.110)	C291150000	PVC jacket	
	RG 178 B/U	2 / 50 S	3 GHz	7 x 0.1	0.30 (.012)	0.84 (.033)	1.78 (.070)	C291145007	FEP jacket	
	RG 178 B/U	2 / 50 S	3 GHz	7 x 0.1	0.30 (.012)	0.84 (.033)	1.83 (.072)	C291145060	PVC jacket	
	RG 178 non m.	2 / 50 S	3 GHz	7 x 0.1	0.29 (.011)	0.84 (.033)	1.80 (.071)	C291140087	Nonmagnetic / FEP jacket	
	RG 179 B/U	2.6 / 75 S	3 GHz	7 x 0.1	0.30 (.012)	1.60 (.063)	2.54 (.010)	C291210007	FEP jacket	
	RG 187 A/U	2.6 / 75 S	3 GHz	7 x 0.1	0.30 (.012)	1.60 (.063)	2.79 (.110)	C291211006	PTFE jacket	
	RG 188 A/U	2.6 / 50 S	3 GHz	7 x 0.17	0.51 (.020)	1.52 (.060)	2.79 (.110)	C291160006	PTFE jacket	
	RG 196 A/U	2 / 50 S	3 GHz	7 x 0.1	0.30 (.012)	0.86 (.034)	2.03 (.080)	C291110006	PTFE jacket	
	RG 212 /U	8 / 50 D		Solid	1.41 (.056)	4.70 (.185)	8.43 (.331)	N/A		
	RG 213 /U	10 / 50 S	1 GHz	7 x 0.75	2.26 (.089)	7.24 (.285)	10.30 (.406)	C291510000	PVC jacket	
	RG 214 /U	11 / 50 D	11 GHz	7 x 0.75	2.25 (.089)	7.24 (.285)	10.80 (.425)	C291600000	PVC jacket	
	RG 215	10 / 50 S		7 x 0.75	2.25 (.089)	7.25 (.285)	10.29 (.405)	N/A		
	RG 216 /U	11 / 75 D	3 GHz	7 x 0.4	1.21 (.048)	7.24 (.285)	10.80 (.425)	C291610000	PVC jacket	
	RG 217 /U	14 / 50 D	3 GHz	Solid	2.69 (.106)	9.40 (.370)	13.84 (.545)	C291620000	PVC jacket	
	RG 218 /U	22 / 50 S	1 GHz	Solid	4.95 (.195)	17.27 (.680)	22.10 (.870)	C291630000	PVC jacket	
	RG 223 /U	5 / 50 D	12.4GHz	Solid	0.89 (.035)	2.95 (.116)	5.38 (.212)	C291330000	PVC jacket	
	RG 225 /U	11 / 50 D	1 GHz	7 x 0.8	2.38 (.094)	7.24 (.285)	10.90 (.429)	C291605007	Glass fiber jacket	
	RG 303 /U	5 / 50 S		Solid	0.94 (.037)	2.95 (.116)	4.32 (.170)	N/A		
	RG 316 /U	2.6 / 50 S	3 GHz	7 x 0.17	0.53 (.021)	1.52 (.060)	2.49 (.098)	C291170007	FEP jacket	
	RD 316	2.6 / 50 D	3 GHz	7 x 0.17	0.53 (.021)	1.52 (.060)	2.80 (.110)	C291185067	FEP jacket	
	RG 393	10 / 50 D	11 GHz	7 x 0.81	2.39 (.094)	7.24 (.285)	9.91 (.390)	C291511007	FEP jacket	
	RG 400	5 / 50 / D	12.4GHz	19 x 0.19	0.98 (.039)	2.95 (.116)	4.95 (.195)	C291324007	FEP jacket	
	Flexible BT approved	RD 179	2.6 / 75 D	3 GHz	7 x 0.10	0.30 (.012)	1.6 (.063)	3.07 (.121)	C291230080	LSZH jacket
		BT 3002	3.6 / 75 D	200MHz	Solid	0.31 (.012)	1.95 (.077)	3.55 (.140)	C291246046	FEP jacket
BT 2002		5 / 75 D	200MHz	7 x 0.20	0.60 (.024)	2.5 (.098)	5.1 (.200)	C291333080	FEP jacket	
Semi-rigid MIL-C-17 standard	RG 401 /U	.250"	20 GHz	Solid	1.63 (.064)	5.31 (.209)	6.35 (.250)	C291870001	Copper tubing	
	RG 401 alu	.250"	20 GHz	Solid	1.63 (.064)	5.31 (.209)	6.35 (.250)	C291874187	Tinned alu tubing	
	RG 402 /U	.141"	20 GHz	Solid	0.92 (.036)	2.98 (.117)	3.58 (.141)	C291860001	Copper tubing	
	RG 402 tin	.141"	20 GHz	Solid	0.92 (.036)	2.98 (.117)	3.58 (.141)	C291862005	Tinned copper tubing	
	RG 402 silver	.141"	20 GHz	Solid	0.92 (.036)	2.98 (.117)	3.58 (.141)	C291861066	Silvered copper tubing	
	RG 402 alu	.141"	20 GHz	Solid	0.92 (.036)	2.98 (.117)	3.58 (.141)	C291864187	Tinned alu tubing	
	RG402nonm.	.141"	20 GHz	Solid	0.92 (.036)	2.98 (.117)	3.58 (.141)	C291861061	Non magnetic / copper tubing	
	RG 405 /U	.085"	20 GHz	Solid	0.51 (.020)	1.68 (.066)	2.20 (.087)	C291850001	Copper tubing	
	RG 405 tin	.085"	20 GHz	Solid	0.51 (.020)	1.68 (.066)	2.20 (.087)	C291850005	Tinned copper tubing	
	RG 405 alu	.085"	20 GHz	Solid	0.51 (.020)	1.68 (.066)	2.20 (.087)	C291844187	Tinned alu tubing	
	RG405nonm.	.085"	20 GHz	Solid	0.51 (.020)	1.68 (.066)	2.20 (.087)	C291851001	Non magnetic / copper tubing	
	.047"	.047"	20 GHz	Solid	0.29 (.011)	0.94 (.037)	1.19 (.047)	C291855001	Copper tubing	
	.047" tin	.047"	20 GHz	Solid	0.29 (.011)	0.94 (.037)	1.19 (.047)	C291855065	Tinned copper tubing	
Hand-formable	Hand-formable	.085"	20 GHz	Solid	0.51 (.020)	1.63 (.064)	2.21 (.087)	C291844065	Tin soaked braid	
	Hand-formable	.141"	20 GHz	Solid	0.92 (.036)	2.95 (.116)	3.50 (.138)	C291864065	Tin soaked braid	
	Hand-formable	.141"	20 GHz	Solid	0.92 (.036)	2.98 (.117)	4.05 (.159)	C291866378	FEP jacket	
	Hand-formable	.141"	20 GHz	Solid	0.92 (.036)	2.98 (.117)	4.50 (.177)	C291866270	LSZH jacket	
Corrugated (w/ helical or ringed/ annual copper tube)	Flexible	1/4"		Solid	2.38 (.094)	6.40 (.252)	8.70 (.343)	N/A	Ringed/annular tube	
	Flexible	1/2"	8.8GHz	Solid	4.80 (.189)	11.6 (.457)	16.35 (.644)	C291972085	Ringed/annular tube	
	Flexible	7/8"		Solid	9.13 (.359)	22.5 (.866)	27.7 (1.091)	N/A	Ringed/annular tube	
	Flexible	1 1/4"		Solid	12.7 (.500)	32.5 (1.28)	39.5 (1.55)	N/A	Ringed/annular tube	
	Flexible	1 5/8"		Solid	17.3 (.681)	43.5 (1.71)	50.5 (1.99)	N/A	Ringed/annular tube	
	Super flexible	1/4"	20 GHz	Solid	1.90 (.075)	4.70 (.185)	7.40 (.291)	C291993080	Helical tube	
	Super flexible	1/4"	12 GHz	Solid	1.90 (.075)	4.40 (.173)	7.70 (.303)	C291993170	Helical tube HCF type	
	Super flexible	3/8"	13.4GHz	Solid	2.60 (.102)	6.30 (.248)	10.8 (.425)	C291996070	Helical tube	
	Super flexible	3/8"	11 GHz	Solid	2.60 (.102)	6.30 (.248)	10.1 (.398)	C291996170	Helical tube HCF type	
	Super flexible	1/2"	10.2GHz	Solid	3.60 (.142)	8.70 (.343)	13.2 (.520)	C291994080	Helical tube	
	Super flexible	1/2"	11.7GHz	Solid	3.60 (.142)	8.3 (.327)	13.5 (.531)	C291994170	Helical tube HCF type	
Super flexible	7/8"	5 GHz	Tube	9.04 (.356)	23.62 (.930)	27.48 (1.082)	C291996580	Helical tube		

This table is intended as a guideline only. For detailed specifications please refer to the relevant standard or to the cable manufacturer's specifications. All dimensions are nominal unless otherwise noted. *LMR is a registered trademark of Times Microwave Systems.

Coaxial Connectors

A. Series

B. Style

C. Electrical Options

Name	P/N Series Prefix Radiall & Radiall AEP	Coupling System				Min. Mating Cycles	Main Cable Types										Frequency		Power (Watt)													
		Press-on Screw-on	Snap-on	Slide-on	Bayonet Lock		Mini-coax 1mm RG178	RG316, RG174	RG58, RG59	RG213, RG214	Semi-rigid & Conformable	Corrugated	50 Ohms	75 Ohms	L	S	C	X	Ku	K	Ka	V	@1 GHz	@FMAX								
BMA	R128				■	500/ 1000		■	■	■	■																22 GHz	450	100 (18GHz)			
BNC HD TV	R140/R141/R142 6500-6999				■	100/500		■	■	■	■	■		◆	◆	■	HD												1000	500		
BNC HT	R316				■	500																							1000	700		
BR2	R605				■	500	Twinax style																									
C	R166				■	500			■	■																				1200	350	
COAXIPACK 2	R694				■	500		■	■																					40	20	
DIN 7/16	R185/R187		■			500																								2000	700	
HN	R176		■			500				■																				1200	850	
IMP	R107		■			20																								20	8	
MC Card	R199/R299			■		5000		■	■																					40	14	
Moebius	R199			■		20000		■	■																					40	14	
MCX	R113/R213			■		500		■	■						◆															150	60	
mQ HT	R321				■	1000				■	■																			1000	700	
MMBX	R223			■		100		■	■																					100	25	
MMCX	R110			■		500		■			■																			60	25	
MML	R302		■		■	30		■																						-	-	
MMS	R209			■		50		■	■							◆														38	15	
MMT	R210			■		500		■	■								◆													38	13	
N/N 18	R161/R162/R163 4000		■			500				■	■	■	■	■	◆																1200	350
NEX10	R180		■		■	100																									-	-
QLI	R184				■	100				■	■	■	■																	1000W (2GHz)		
QMA	R123				■	100		■	■		■																			450	180	

◆50 Ohms ■75 Ohms - Note: This table is intended for information only. Some characteristics may change due to different environment/usage. Please consult our Technical Data Sheets.

Conversion Charts

Inch/mm conversion chart

Fractional (in.)	Decimal (in.)	mm
	0.0039	0.1000
	0.0079	0.2000
	0.0118	0.3000
1/64	0.0156	0.3969
	0.0157	0.4000
	0.0197	0.5000
	0.0236	0.6000
	0.0276	0.7000
1/32	0.0313	0.7938
	0.0315	0.8000
	0.0354	0.9000
	0.0394	1.0000
1/16	0.0625	1.5875
	0.0787	2.0000
	0.1181	3.0000
1/8	0.1250	3.1750
	0.1969	5.0000

To convert to millimeters: Inches x 25.4

To convert to inches: mm x 0.0394

Radio Band Designations

Frequency	Designation
30 - 300 Hz	ELF
30 - 3000 Hz	ULF
3 - 30 kHz	VLF
30 - 300 kHz	LF
300 - 3000 kHz	MF
3 - 30 MHz	HF
30 - 300 MHz	VHF
300 - 3000 MHz	UHF
3 - 30 GHz	SHF
30 - 300 GHz	EHF

IEEE Radar Band Designations

Frequency	Designation
1 - 2 GHz	L Band
2 - 4 GHz	S Band
4 - 8 GHz	C Band
8 - 12 GHz	X Band
12 - 18 GHz	Ku Band
18 - 27 GHz	K Band
27 - 40 GHz	Ka Band
40 - 75 GHz	V Band
75 - 110 GHz	W Band
110 - 300 GHz	mm Band
300 - 3000 GHz	u mm Band

Table of return loss vs. VSWR

VSWR	Return loss (dB)	Trans. loss (dB)	Volt. refl coeff.	Trans. power (%)	Refl. power (%)
1.00	99.9	0.000	0.00	100.0	0.0
1.01	46.1	0.000	0.00	100.0	0.0
1.02	40.1	0.000	0.01	100.0	0.0
1.03	36.6	0.001	0.01	100.0	0.0
1.04	34.2	0.002	0.02	100.0	0.0
1.05	32.3	0.003	0.02	99.9	0.1
1.06	30.4	0.004	0.03	99.9	0.1
1.07	29.4	0.005	0.03	99.9	0.1
1.08	28.3	0.006	0.04	99.9	0.1
1.09	27.3	0.008	0.04	99.8	0.2
1.10	26.4	0.010	0.05	99.8	0.2
1.11	25.7	0.012	0.05	99.7	0.3
1.12	24.9	0.014	0.06	99.7	0.3
1.13	24.3	0.016	0.06	99.6	0.4
1.14	23.7	0.019	0.07	99.6	0.4
1.15	23.1	0.021	0.07	99.5	0.5
1.16	22.6	0.024	0.07	99.5	0.5
1.17	22.1	0.027	0.08	99.4	0.6
1.18	21.7	0.030	0.08	99.3	0.7
1.19	21.2	0.033	0.09	99.2	0.8
1.20	20.8	0.036	0.09	99.2	0.8
1.21	20.4	0.039	0.10	99.1	0.9
1.22	20.1	0.043	0.10	99.0	1.0
1.23	19.7	0.046	0.10	98.9	1.1
1.24	19.4	0.050	0.11	98.9	1.1
1.25	19.1	0.054	0.11	98.8	1.2
1.26	18.8	0.058	0.12	98.7	1.3
1.27	18.5	0.062	0.12	98.6	1.4
1.28	18.2	0.066	0.12	98.5	1.5
1.29	17.9	0.070	0.13	98.4	1.6
1.30	17.7	0.075	0.13	98.3	1.7
1.32	17.2	0.083	0.14	98.10	1.9
1.34	16.8	0.093	0.15	97.90	2.1
1.36	16.3	0.102	0.15	97.70	2.3
1.38	15.9	0.112	0.16	97.50	2.5
1.40	15.6	0.122	0.17	97.20	2.8
1.42	15.2	0.133	0.17	97.00	3.0
1.44	14.9	0.144	0.18	96.70	3.3
1.46	14.6	0.155	0.19	96.50	3.5
1.48	14.3	0.166	0.19	96.30	3.7
1.50	14.0	0.177	0.20	96.00	4.0
1.52	13.7	0.189	0.21	95.70	4.3
1.54	13.4	0.201	0.21	95.50	4.5
1.56	13.2	0.213	0.22	95.20	4.8
1.58	13.0	0.225	0.22	94.90	5.1
1.60	12.7	0.238	0.23	94.70	5.3
1.62	12.5	0.250	0.24	94.40	5.6
1.64	12.3	0.263	0.24	94.10	5.9
1.66	12.1	0.276	0.25	93.80	6.2
1.68	11.9	0.289	0.25	93.60	6.4
1.70	11.7	0.302	0.26	93.30	6.7
1.72	11.5	0.315	0.26	93.00	7.0
1.74	11.4	0.329	0.27	92.10	7.3
1.76	11.2	0.342	0.28	92.40	7.6
1.78	11.0	0.356	0.28	92.10	7.9
1.80	10.9	0.370	0.29	91.80	8.2
1.82	10.7	0.384	0.29	91.50	8.5
1.84	10.6	0.398	0.30	91.30	8.7
1.86	10.4	0.412	0.30	91.00	9.0
1.88	10.3	0.426	0.31	90.70	9.3
1.90	10.2	0.440	0.31	90.40	9.6
1.92	10.0	0.454	0.32	90.10	9.9



MCX / MMCX / MMS / MMT / MML

R113 / R110 / R209 / R210 / R302



Contents

MML

Introduction 1-4
 Characteristics 1-4
 Pigtails 1-5
 Cable assemblies 1-5 to 1-6
 Receptacles 1-6
 Adapters 1-7

MMS/MMT

Introduction 1-8
 Characteristics 1-9 to 1-10
 Plugs 1-11
 Pigtails 1-11
 Cable assemblies 1-11 to 1-12
 Receptacles 1-12
 Adapters 1-12
 Extraction tool 1-13
 Measurement cable assemblies 1-13
 Assembly instructions 1-13

MMCX

Introduction 1-14
 Interface 1-14
 Characteristics mmcX 1-15
 Characteristics eco mmcX 1-15
 Plugs 1-16
 Receptacles 1-16 to 1-17
 Panel drilling 1-17
 Assembly instructions 1-18

MCX

Introduction 1-19
 Interface 1-19
 Characteristics 1-20
 Plugs 1-21 to 1-22
 Jacks 1-22
 Receptacles 1-23 to 1-24
 In series adapters 1-24
 Panel drilling 1-25
 Packaging 1-25
 Assembly instructions 1-26

Introduction

RADIALL has developed a new MML series to address the market demand for smaller microminiature coaxial connectors for applications such as cell relay, WiFi access points, GPS and other mobile terminals. There are three types of plugs with mated heights of H2.5, H2.0 and H1.5, as well as two types of vertical PCB receptacles with electrical performance up to 6 GHz.

FEATURES

- Two vertical PCB receptacles
 - MML H2.5 and MML H2.0
 - MML H1.5
- Space saving
 - Three mated heights 2.5 mm, 2.0 mm, 1.5 mm
 - PCB patterns 3.08 mm x 3 mm for H2.5 and H2.0, 2 mm x 2 mm for H1.5
- DC - 6GHz, typical VSWR 1.35 max
- Cable assemblies are offered with three high performance cables: 1.33 mm for MML H2.5, 1.13 mm for MML H2.0, 0.81 mm for MML H1.5

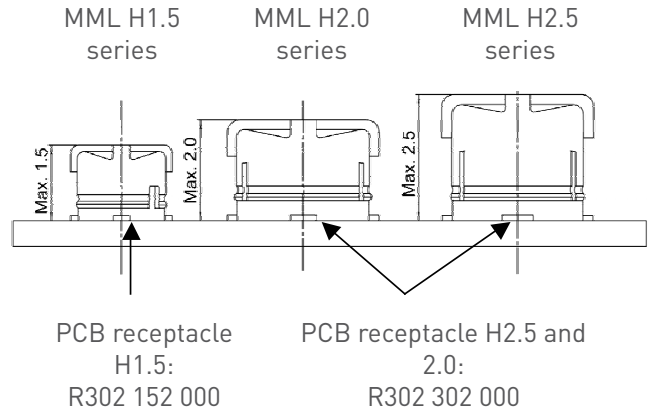

APPLICATIONS

- Handhelds/GPS/WLAN
- GSM/CDMA/WCDMA/TD-SCDMA cards

Characteristics

	Values / Remarks
--	------------------

ELECTRICAL CHARACTERISTICS

Nominal impedance	50Ω
Frequency range	DC - 6 GHz
Typical VSWR	1.35 max
Contact resistance <ul style="list-style-type: none"> • Center contact • Outer contact 	25 mΩ 15 mΩ
Insulation resistance	500 MΩ min
Voltage rating <ul style="list-style-type: none"> • H2.5 and H2 • H1.5 	200 Vrms 150 Vrms
Withstanding voltage <ul style="list-style-type: none"> • H2.5 and H2 • H1.5 	300 Vrms 200 Vrms
Mechanical durability	30 cycles
Center contact axial force	0.15 N
RoHS	Compliant
Temperature range	-40 / +90°C
Humidity	96 hours at temperature of 40°C and humidity of 95%
Corrosion (salt spray)	5% salt water solution, 48 hours

MATERIALS AND PLATING

	Materials	Platings
Connector bodies	Phosphor Bronze	Gold
Female center contact		
Male center contact	Brass	

Pigtails and cable assemblies

MML PIGTAILS

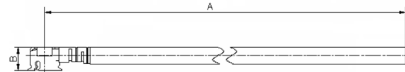

Fig. 1



Fig. 2

Cable group dia.	MML type	Part number	Fig.	Dimensions (mm)	Packaging
				A	
1.33/50/S	H2.5	R302 255 003 xxx	1	xxx (500 mm max)	100
1.13/50/S	H2.0	R302 205 001 xxx	2	xxx (400 mm max)	
0.81/50/S	H1.5	R302 155 000 xxx			

MML to MML CABLE ASSEMBLIES

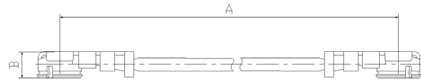
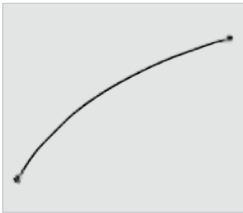

Cable group dia.	MML type	Part number	Dimensions (mm)	Packaging
			A	
1.33/50/S	H5	R302 000 000 xxx	xxx (500 mm max)	100
1.13/50/S	H0	R302 205 000	100	
0.81/50/S	H1.5	R302 155 001		

MML to SMA PLUG CABLE ASSEMBLIES

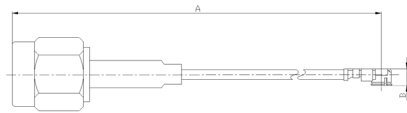
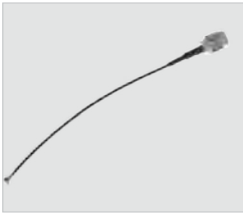

Cable group dia.	MML type	Part number	Dimensions (mm)	Packaging
			A	
1.33/50/S	H2.5	R302 255 002 xxx	xxx (400 mm max)	100
1.13/50/S	H2.0	R302 205 002	100	

Note:
xxx = length in mm

Length	Step	Tolerance
30 to 100 mm	10 mm	±2 mm
110 to 200 mm		±3 mm
225 to 300 mm	25 mm	±5 mm
325 to 500 mm		±10 mm

Cable assemblies and receptacles

MML to SMA BULKHEAD JACK CABLE ASSEMBLIES

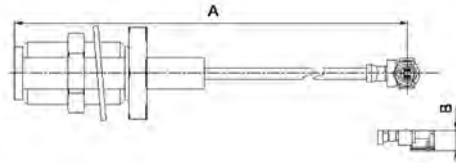
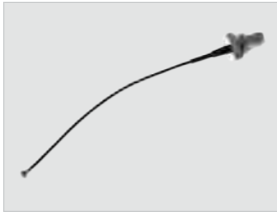

Cable group dia.	MML type	Part number	Dimensions	Packaging	Note		
1.37 / 50 / S	H2.5	R302 255 000 xxx	xxx (400 mm max)	100			
		R302 255 001 xxx			SMA panel seal		
1.13 / 50S	H2.0	R302 205 003 xxx					
		R302 255 014 xxx			SMA panel seal		

Note:

xxx = length in mm

Length	Step	Tolerance
30 to 100 mm	10 mm	±2 mm
110 to 200 mm		±3 mm
225 to 300 mm	25 mm	±5 mm
325 to 500 mm		±10 mm

MML to RP SMA BULKHEAD REVERSE POLARITY CABLE ASSEMBLIES

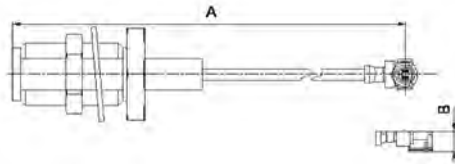
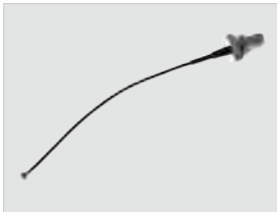

Cable group dia.	MML type	Part number	Dimensions	Packaging	Note
1.37 / 50 / S	H2.5	R302 255 015 xxx	xxx (400 mm max)	100	
		R302 255 006 xxx			RP SMA panel seal

SMT RECEPTACLES

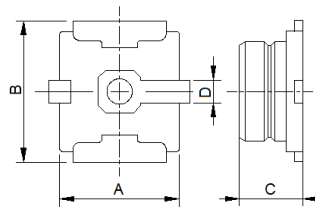

MML type	Part number	Dimensions				Packaging
		A	B	C	D	
H2.5 & H2.0	R302 302 000	2.6	2.6	1.3	0.6	5000 piece / reel
H1.5	R302 152 000	1.7	1.7	0.85	0.3	5000 piece / reel

Adapters and test probe

ADAPTERS

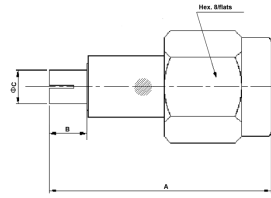

Fig. 1

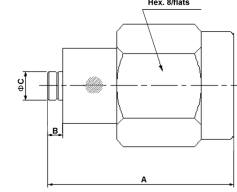
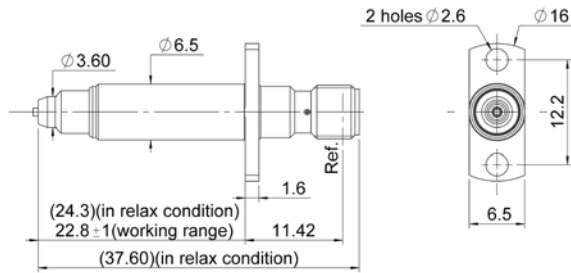

Fig. 2

MML type	Part number	Fig.	Dimensions			Note
			A	B	C	
H2.5 & H2.0	R302 303 000	2	13.2	1.05	1.98	MML plug - SMA plug
	R302 303 001	1	17.2	2.9	2.6	
H1.5	R302 153 000	1	17.2	2.9	2.1	MML jack - SMA plug
	R302 153 001	2	12.9	0.78	1.4	

MML TEST PROBE



Part number	Interface 1	Interface 2
R191 597 800	MML H2.0 / H2.5	SMA female

Introduction

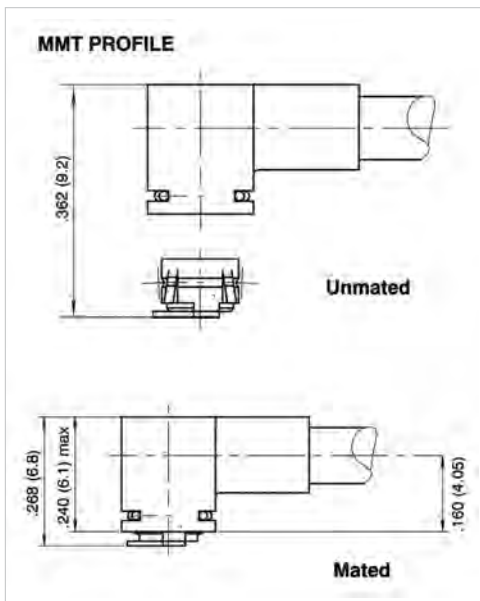
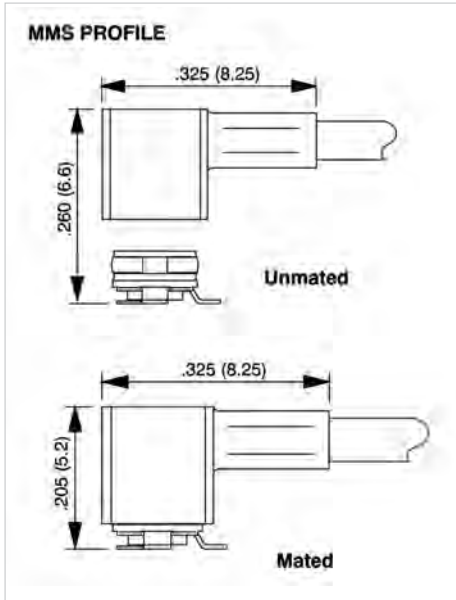
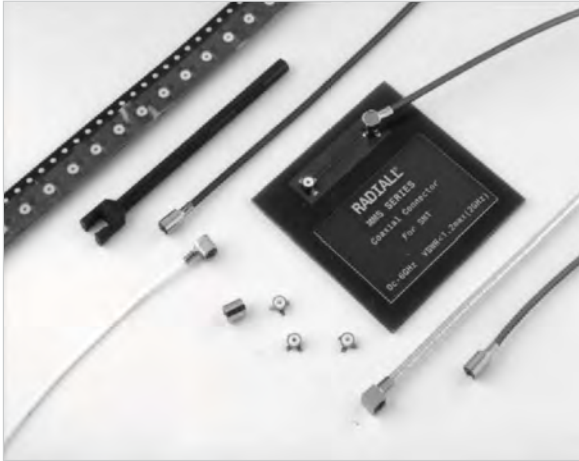

	MMS	MMT
50Ω	DC - 6 GHz	DC - 8 GHz
75Ω	DC - 1 GHz	

GENERAL

- Low profile coaxial connectors
- Surface-mount receptacle (SMT)
- Snap-on mating
- High RF performance
- 360° cable rotation

APPLICATIONS

- Automotive
- Satellite reception terminals (GPS...)
- Instrumentation
- Wireless datacom networks
- Automated payment systems
- Video communications
- Other general electronics

Radiall introduced MMS and MMT connectors, dedicated to Surface Mount Technology (SMT), in the 1990s.

MMS and MMT series were the first coaxial connectors truly designed for SMT applications and adapted for automatic pick and place machines.

• **360° cable rotation**

The **MMS** and **MMT** snap-on mating system ensures a correct positive connection each time and all connectors (plugs + receptacles) have a design which allows a 360° rotation of the pair when mated.

• **MMS vs MMT**

MMS and **MMT** connectors are dedicated to similar applications. The choice between these 2 series will be driven by mating life cycle required for the application. MMS is dedicated to applications which require only few mating/unmating cycles. MMT provide stronger retention force while allowing more manipulation.

	MMS	MMT
Durability (mating cycle)	50	500
Frequency range	50Ω DC - 6 GHz 75Ω DC - 1 GHz	50Ω DC - 8 GHz 75Ω DC - 1 GHz
Mated height	5.2 mm	6.8 mm

Characteristics

	Test standard	Values / Remarks
--	---------------	------------------

ELECTRICAL CHARACTERISTICS

		50Ω	75Ω
Frequency range		DC - 6 GHz	DC - 1 GHz
Typical V.S.W.R. (mated pair)	IEC 1169-1	1.05 at 1 GHz 1.15 at 2.5 GHz 1.35 at 6 GHz	
Insertion loss	IEC 1169-1	0.2 dB at 2 GHz	
RF leakage (mated pair)	MIL STD 1344 method 3008	-50 dB at 500 MHz -45 dB at 1 GHz -40 dB at 2 GHz	
Outer contact resistance	NF-C 93050 (I = 40 mA peak)	5 mΩ max	
Center contact resistance	NF-C 93050 (I = 40 mA peak)	15 mΩ max	
Insulation resistance	IEC 1169-1	500 MΩ min (under 250 V RMS)	
Working voltage		50 V RMS	
Testing voltage (V RMS)	IEC 1169-1	Ø 1 mm: 250 ; Ø 2 mm: 500	
Maximum admissible power		40 W at 1 GHz / 20°C / V.S.W.R. = 1	

MECHANICAL CHARACTERISTICS

Durability	IEC 1169-1	50 matings
Force to engage	IEC 1169-1	7 N avg
Force to disengage	IEC 1169-1	5.5 N avg
Shocks (drop test)	IEC 68-2-27	50 g/11 ms ; 3 shocks / axis / way
Random vibrations	General Motors spec.	Sine waves 5 to 1000 Hz 3 to 30g - 1 H/axis
Bumps (mechanical shocks)	IEC 68-2-29	25 g/6 ms 1000 bumps / axis / way
Cable retention force	IEC 1169-1	Ø 1 mm: 20 N ; Ø 2 mm: 35 N
Solderability	IEC 68-2-54	Passed

ENVIRONMENTAL CHARACTERISTICS

Temperature range		-40°C / +90°C
Climatic cycles	GAM T 13	48 H at 70°C - 24 H at 40°C / 93% -36 H at -25°C

MATERIALS

Bodies plugs/in-series adapters		Die cast zinc / brass
Bodies receptacles		Phosphor bronze
Center contact		Brass
• Male		Beryllium copper
• Female		
Insulator		PTFE

PLATING

Bodies plugs/in series adapters		Nickel
Bodies receptacles		Gold
Center contact		Nickel
• Male		Gold
• Female		

RF LEAKAGE AND V.S.W.R

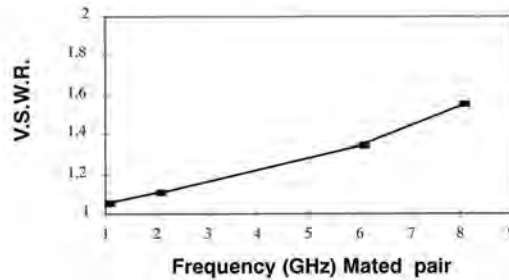
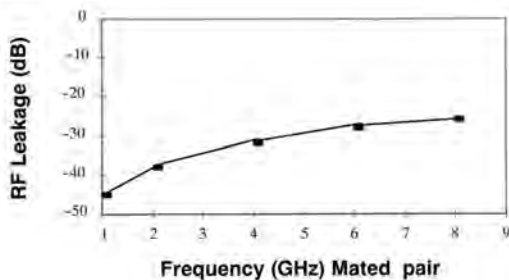

Characteristics

	Test standard	Values / Remarks
ELECTRICAL CHARACTERISTICS		
Impedance		50Ω
Frequency range		DC - 8 GHz
Typical V.S.W.R. (mated pair)	IEC 1169-1	75Ω 1.05 at 1 GHz 1.10 at 2.5 GHz 1.15 at 6 GHz
Insertion loss	IEC 1169-1	≤ 0.2 V F (GHz)
RF leakage (mated pair)	IEC 1726	-42 dB at 500 MHz -38 dB at 1 GHz -30 dB at 3 GHz
Outer contact resistance	IEC 1169-1 (I=40 mA eff.)	Initial: 2.5 mΩ max Final: 12.5 mΩ max
Center contact resistance	IEC 1169-1 (I=40 mA eff.)	Initial: 5 mΩ max Final: 15 mΩ max
Insulation resistance	IEC 1169-1	≥ 5000 MΩ under 500 Vcc
Working voltage		170 V eff.
Testing voltage	IEC 1169-1	500 V eff.
Maximum admissible power		23 W at 1.8 GHz / 40°C / V.S.W.R. = 1.1

MECHANICAL CHARACTERISTICS

Durability	IEC 1169-1	500 matings
Force to engage/disengage	IEC 1169-1	Ins ≤ 18 N Ext > 7 N
Shocks	IEC 68-2-27	passed
Vibrations	IEC 68-2-6	passed
Bumps	IEC 68-2-29	passed
Cable retention force	IEC 1169-1	∅ 2 mm: 20 N ; ∅ 2.6 mm: 60 N
Solderability	IEC 68-2-29	Passed

ENVIRONMENTAL CHARACTERISTICS

Temperature range		55°C / 100°C
Damp heat	IEC 68-23	Passed
Thermal shocks	IEC 68-2-14 / Test NA	Passed

MATERIALS

Plugs body/in-series adaptor	Brass
Receptacles body	CuSn9p
Plugs center contact	Cube2
Receptacles center contact	Brass
Insulators	PTFE, Delrin

PLATING

Bodies plugs/in series adapters	Nickel / BBR
Bodies receptacles	Gold
Plugs center contact	Gold
Receptacles center contact	Gold

RF LEAKAGE AND V.S.W.R

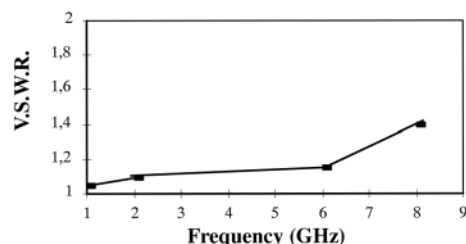
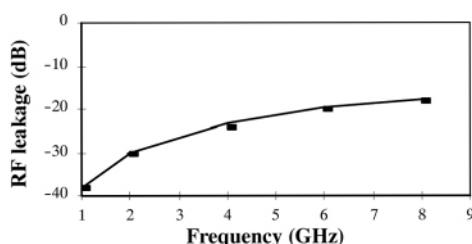

Plugs, pigtails and cable assemblies

RIGHT ANGLE PLUGS CRIMP TYPE FOR FLEXIBLE CABLES

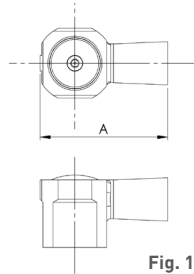
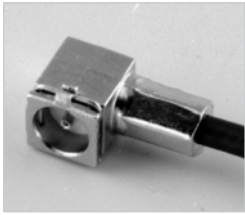

Fig. 1

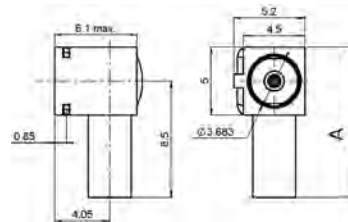
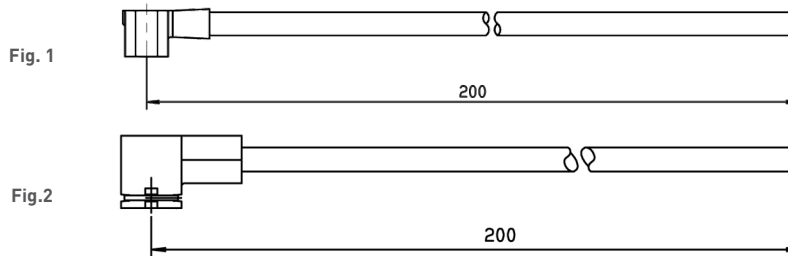
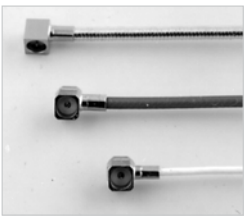

Fig. 2

Series	Cable group	Cable group dia.	Part number	Fig.	Imp. (Ω)	Dimensions A (mm)	Captive center contact	Finish
MMS	RG178 / RG196	2/50/S	R209 353 000	1	50	8.25	yes	Nickel
		1/50/S	R209 351 020			7.2		
MMT	RG178 / RG196	2/50/S	R210 160 020	2	50	11		
	RG174 / RG316	2.6/50/S	R210 157 010			10		

PIGTAILS



Series	Cable group	Cable group dia.	Part number	Fig.	Composition
MMS	RG178 / RG196	2/50/S	R285 001 021	1	R209 353 000 + C291 145 007
MMT	RG178 / RG196	2/50/S	R284 008 001	2	R210 160 020 + C291 145 007
	RG174 / RG316	2.6/50/S	R284 008 004		R210 157 010 + C291 150 000

CABLE ASSEMBLIES

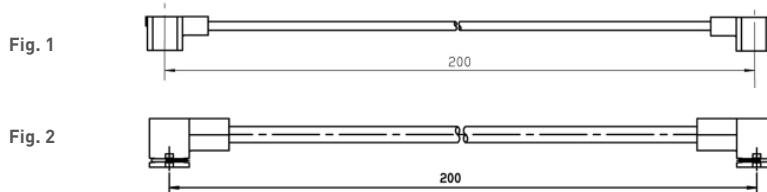
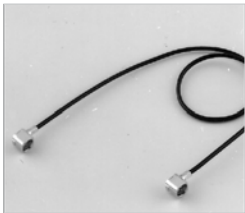

Series	Cable group	Cable group dia.	Part number	Fig.	Composition
MMS	-	1/50/S	R285 004 001	1	R209 351 020 + R291 050 066 + R209 351 020
	RG178 / RG196	2/50/S	R285 004 221		R209 353 000 + C291 145 007 + R209 353 000
MMT	RG178 / RG196	2/50/S	R285 011 221	2	R210 160 020 + C291 145 007 + R210 160 020

All dimensions are given in mm.

MMS/MMT

Cable assemblies, receptacles and adapters

CUSTOM CABLE ASSEMBLIES

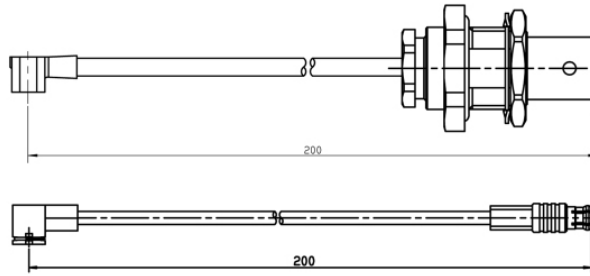
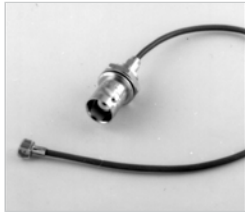

Contact us for all your cable assembly needs.

SMT RECEPTACLES

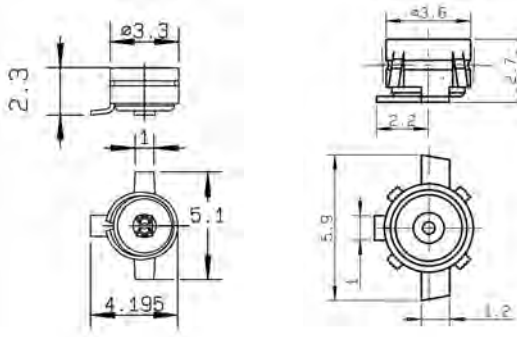
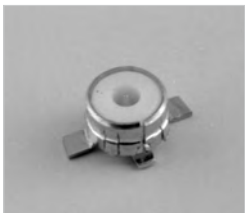

Fig. 1

Fig. 2

Series	Part number	Fig.	Imp. (Ω)	Center contact finish	Finish	Packaging	Reel dia.
MMS	R209 408 012	1	50	Gold	Gold	Tape & Reel 100 pieces	180
	R209 408 052					Tape & Reel 500 pieces	180
	R209 408 302					Tape & Reel 3000 pieces	330
MMT	R210 408 012	2	50	Gold	Gold	Tape & Reel 100 pieces	180
	R210 408 052					Tape & Reel 500 pieces	180
	R210 408 302					Tape & Reel 3000 pieces	330

ADAPTERS

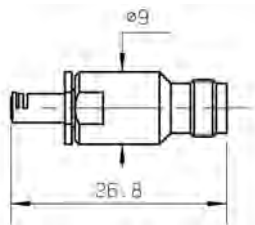

Fig. 1

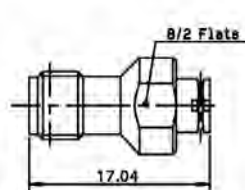

Fig. 2

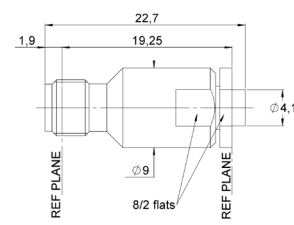

Fig. 4

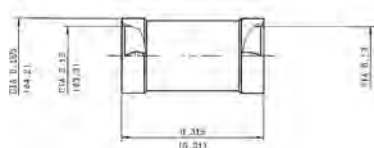

Fig. 3

Series	Part number	Fig.	Type	Finish
MMS	R191 975 791	1	MMS female / SMA female	Passivated stainless steel
	R191 975 781	-	MMS male / SMA female	
	R209 703 070	3	MMS male / MMS male	Ni
MMT	R191 394 027	2	MMT female / SMA female	BBR

Measurement cable assemblies and tooling

MEASUREMENT CABLE ASSEMBLIES

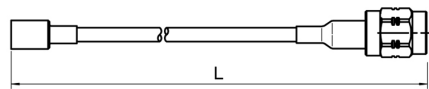

Fig. 1

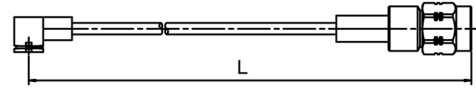
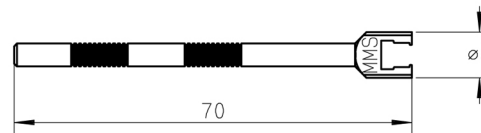

Fig. 2

Series	Cable group	Cable group dia.	Part number	Fig.	Composition	Length L (mm)
MMS ⁽¹⁾	RG178 / RG196	2/50/S	R284 007 013	1	R209 080 500 + C291 145 007 + R124 069 120	150
MMT	RD316	2.6/50/D	R285 024 071	2	R210 158 010 + C291 185 067 + R124 072 220	200

⁽¹⁾ Both cable assemblies are equipped with a straight MMS plug with a sliding interface to allow 500 matings and a SMA connector.

EXTRACTION TOOL



Materials and finish: black anodized aluminium
The anodization allows the electric insulation and protects from the oxidation.

Series	Part number
MMS	R282 868 100
MMT	R282 868 040

Procedure for use of SMT Nozzle for Receptacle

Ø OF NOZZLE > 1.2 mm
Suction with the central contact hole.

Ø OF NOZZLE < 1.2 mm
Suction with insulator.

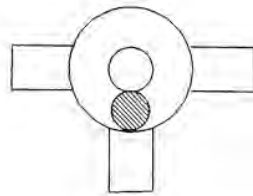
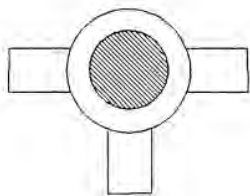

ASPIRATION AREA

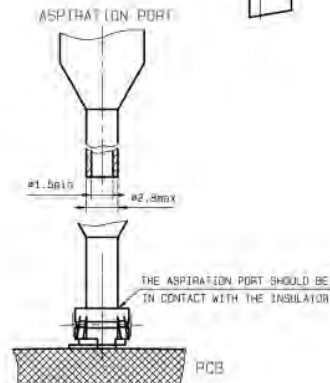
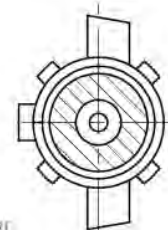

Introduction



50 Ω

DC - 6 GHz

GENERAL

- Subminiature coaxial connectors
- Push-pull snap-on mating
- Complies with specification CECC 22000

APPLICATIONS

- Wireless telecom
- PCMCIA cards
- RF test ports
- Medical

MMCX series is dedicated for wire to PCB connection where low space above the PCB is available (less than 2.1 mm). MMCX is adapted to high volume applications and Pick & Place manufacturing processes.

Interface

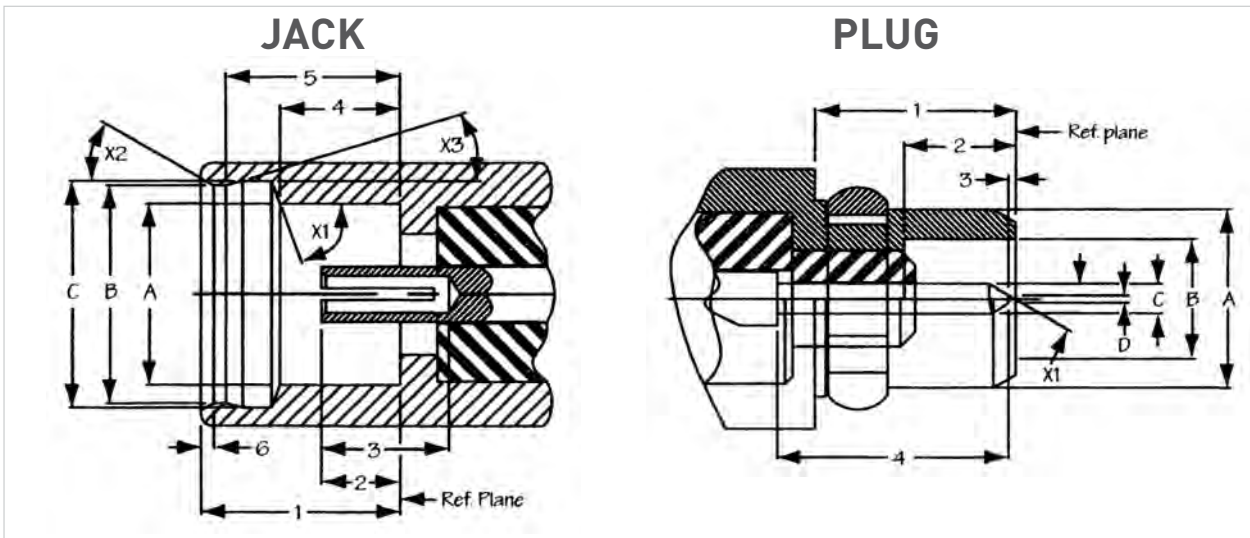

Letter	mm		inch	
	min.	max.	min.	max.
1	2.60		.102	
2	0.90	1.20	.035	.047
3	1.40		.055	
4	1.57	1.63	.062	.064
5	2.30	2.34	.091	.092
6		0.23		.009
A	2.41		.095	
B	2.88	2.90	.113	.114
C	3.00	3.04	.118	.120
X1	68°	72°		
X2	28°	32°		
X3	13°	17°		

Letter	mm		inch	
	min.	max.	min.	max.
1	2.70		.106	
2	1.45		.057	
3	0	0.25		.010
4		3.15		.124
A	2.40		.095	
B	1.58	1.62	.062	.064
C	0.38	0.42	.015	.017
D		0.20		.008
X1	29°	31°		

Characteristics

	Test standard	Values / Remarks
--	---------------	------------------

ELECTRICAL CHARACTERISTICS

Impedance		50Ω
Frequency range		DC - 6 GHz
V.S.W.R.	CECC 22000 4.4.1	Edge card SMT: 1.40 max Cabled: 1.35 max
Dielectric withstanding voltage (at sea level)	CECC 22000 4.4.5	500 V RMS 50 Hz
Insulation resistance	CECC 22000 4.4.4	1000 MΩ min

MECHANICAL CHARACTERISTICS

Engagement force	CECC 22000 4.5.4	3.5 lbs max
Disengagement force	CECC 22000 4.5.4	1.4 lbs to 3.4 lbs max
Contact captivation	CECC 22000 4.5.2	2.3 lbs min
Durability (mating)	CECC 22000 4.7.1	500 cycles min

ENVIRONMENTAL CHARACTERISTICS

Temperature range		-55°C / +155°C
Temperature shock	CECC 22000 4.6.7	compliant
Vibration	CECC 22000 4.6.3	compliant

MATERIALS AND PLATING

	Materials	PLatings
Bodies	Brass	Gold
Center contact • Male • Female	Brass Beryllium copper	Gold
Insulator	PTFE	

These characteristics are typical and may not apply to all connectors.

Characteristics eco mmcX

ELECTRICAL AND MECHANICAL CHARACTERISTICS

Impedance		50Ω
Frequency range		DC - 3 GHz
Typical VSWR		1.35 at 3 GHz
Temperature range		- 40°C / + 85°C
Mating cycles		100 mating cycles

MATERIALS AND PLATING

	Materials	PLatings
Connector body	Brass	Gold
Insulator	PTFE / Polypropylene	
Female center contact	Beryllium copper	Gold
Outer contact	Brass	

PACKAGING

Packaging		100 pieces bulk 500 pieces reel 1500 pieces reel Unit packaging
-----------	--	--

Plugs and receptacles

STRAIGHT PLUGS

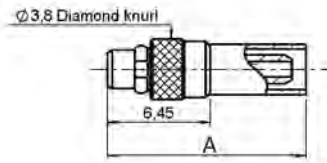

Cable group	Cable group dia.	Part number	Dimensions A (mm)	Packaging	Note
RG178 / RG196	2/50/S	R110 081 020	12.45	100	Full crimp type
RG174 / RG176	2.6/50/S	R110 083 120	13.35		

RIGHT ANGLE PLUGS

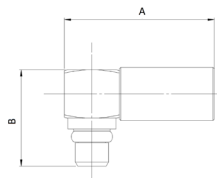

Cable group	Cable group dia.	Part number	Dimensions (mm)		Packaging	Note
			A	B		
RG178 / RG196	2/50/S	R110 170 100	10.9	7	100	
		R110A 170 100	11	9.1	1000	ECO version
RG174 / RG316	2.6/50/S	R110 172 100	10.9	7	100	
		R110A 172 100	12.5	8	1000	ECO version
RG405	.085"	R110 153 000	7	7	100	Solder type

PCB EDGE CARD RECEPTACLES

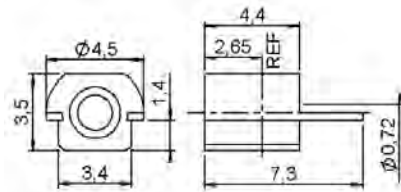

Part number	Gender	Assembly instructions	Packaging	Note
R110 422 100	Jack	M03	100	SMT
R110A 422 830			Tape & Reel of 1500 pieces	ECO version

STRAIGHT PLUG RECEPTACLES

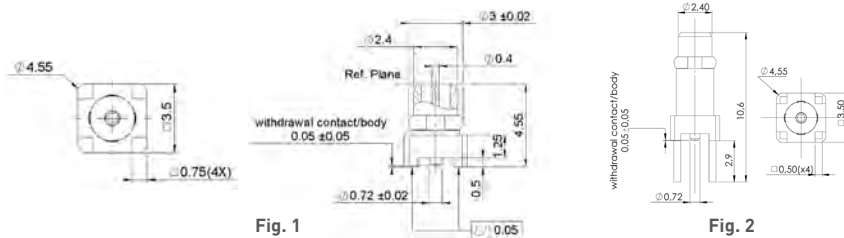

Part number	Fig.	Assembly instructions	Panel Drilling	Packaging	Note
R110 434 100	2		P01	100	PCB
R110 434 860	1	M04		Tape & Reel of 500 pieces	SMT

Receptacles and in series adapters

STRAIGHT JACK RECEPTACLES

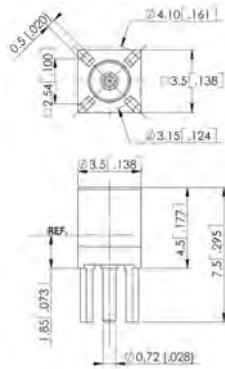

Fig. 1

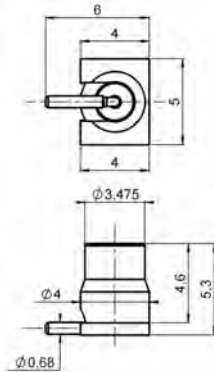

Fig. 2

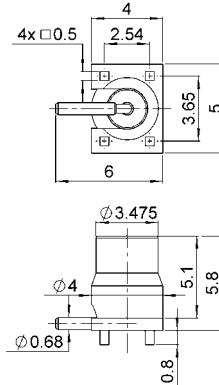

Fig. 3

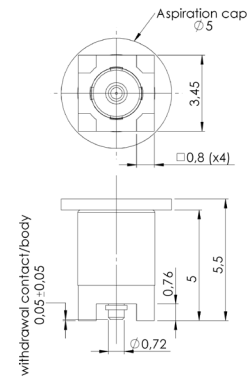
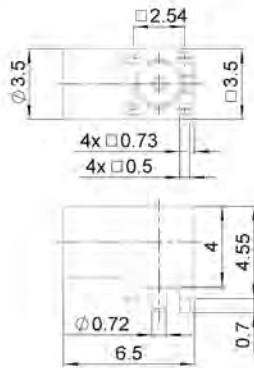

Fig. 4

Part number	Fig.	Panel drilling	Assembly instructions	Packaging	Note
R110 426 000	1	P01		100	Solder legs
R110A 426 000					ECO version
R110 427 810	4	-	-	500	SMT
R110 427 820	2		M01	Tape & Reel of 500 pieces	
R110A 427 830	3		M02		ECO version

RIGHT ANGLE JACK RECEPTACLE



Part number	Panel drilling	Packaging
R110 665 860	P02	500

IN SERIES ADAPTER

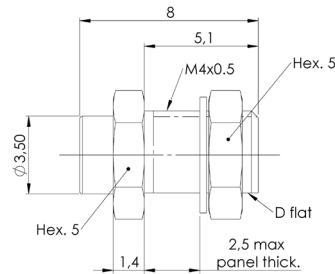

Part number	Type	Finish
R110 704 103	female to female	Gold

Panel drilling

P01

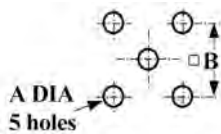

	mm		inch	
	max.	min.	max.	min.
A	0.85	0.75	.033	.030
B	2.56	2.52	.101	.099

P02

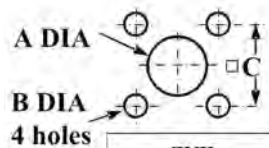

	mm	
	Maxi	mini
A	1.05	0.95
B	0.9	0.8
C	2.56	2.52

Assembly instructions

M01

SOLDERING PATTERN

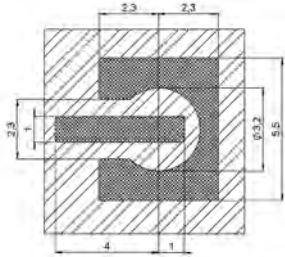

Part number
R110 427 820

- Ground + varnish
- Lands for solder paste

VIDEO SHADOWS

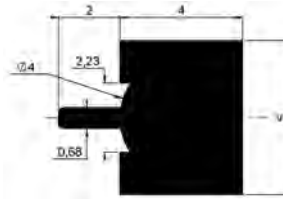

M02

SOLDERING PATTERN

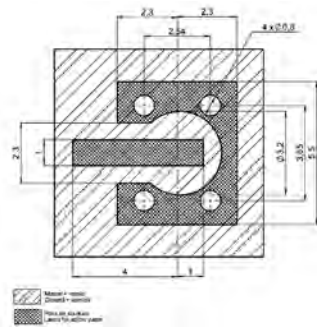

Part number
R110A 427 830

VIDEO SHADOWS

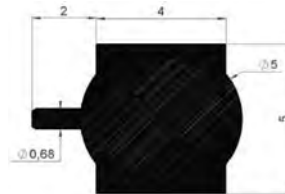

M03

SOLDERING PATTERN

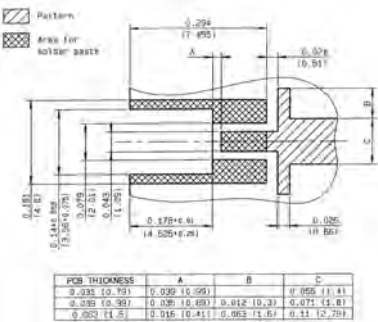

Part number
R110 422 100
R110A 422 830

VIDEO SHADOWS

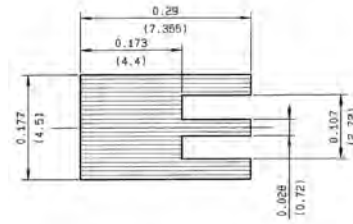

M04

SOLDERING PATTERN

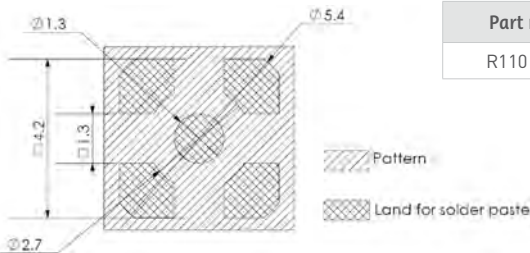

Part number
R110 434 860

- Pattern
- Land for solder paste

Introduction

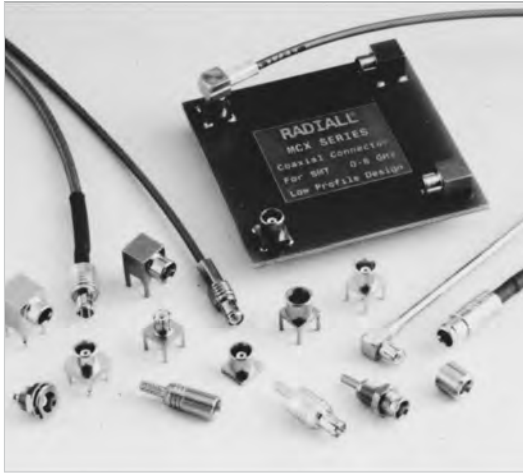

50Ω - 75Ω	DC - 6 GHz
-----------	------------

GENERAL

- Subminiature coaxial connectors
- Push-pull snap-on mating
- Complies with specification CECC 22220
- CEI standard 1169-36

APPLICATIONS

50Ω models

- Wireless communications
- Civil and military radio-telecommunication equipment

75Ω models

- Video communication
- Television broadcasting

The MCX series utilizes the SMB series electrical line and features a particularly simple, compact and robust interface. The MCX series is 30 % smaller than the SMB. The MCX series helps to **miniaturize equipment**. It lowers wiring connection costs through its full crimp and solder crimp versions as the center contact of the straight models can be either crimped or soldered. It optimizes PCB layouts with its range of models for PCBs including surface mount and press-fit receptacles.

Interface

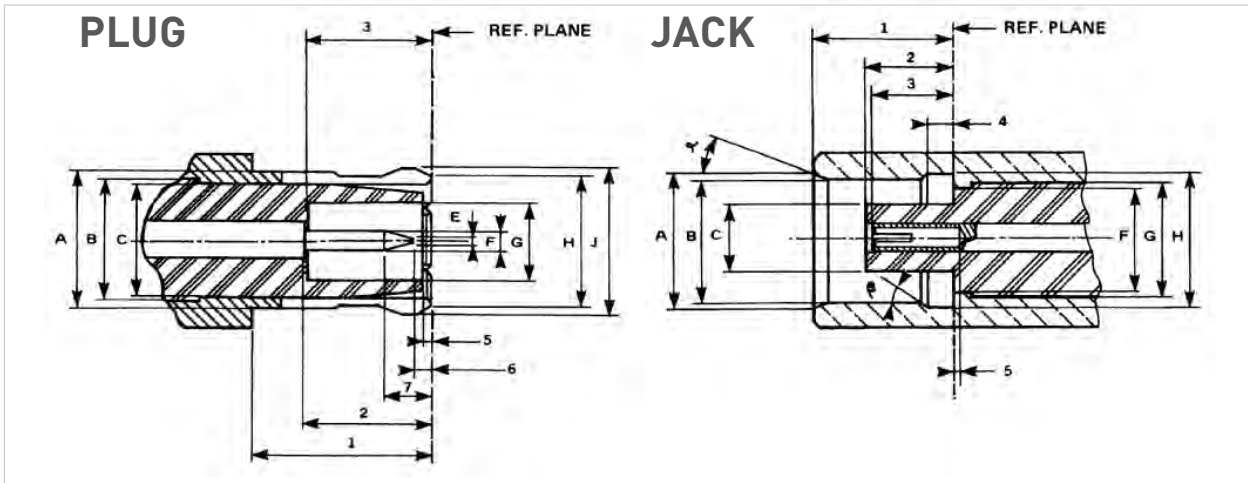

ITEM	mm		inch	
	min.	max.	min.	max.
1	4.15	-	.163	
2	2.80	3.20	.110	.126
3	2.80		.110	
5	0	0.30	0	.012
6	0.15		.006	
7		1.20		.047
A		3.40		.134
B	3.05 nom.		.120 nom.	
C		3.00		.118
E		0.25		.010
F	0.48	0.53	.019	.021
G	2.00		.079	
H		3.60		.142
J		3.80		.150

ITEM	mm		inch	
	min.	max.	min.	max.
1	4.00	4.12	.157	.162
2	2.60	2.80	.102	.110
3	2.30	2.80	.090	.110
4	0.75	0.85	.029	.033
5	0		0	
a	18°	22°	18°	22°
β	43°	47°	43°	47°
A	3.80		.150	
B	3.42	3.48	.135	.137
C		1.98		.078
F		3.00		.118
G	3.05 nom.		3.05 nom.	
H	3.60	3.75	.142	.148

Characteristics

Test / Characteristics	Values / Remarks		
ELECTRICAL CHARACTERISTICS			
Impedance	50Ω and 75Ω		
Frequency range	DC - 6 GHz		
Typical V.S.W.R. • Straight styles: .085 2.6/50/S • Sight angle styles: .085 2.6/50/S	1 GHz 1.04 1.06 1.03 1.04	2.5 GHz 1.08 1.09 1.06 1.07	6 GHz 1.13 1.12 1.10 1.10
Insulation resistance	1 000 MΩ		
Contact resistance (mΩ) • Center contact • Outer contact	Initial ≤ 5 ≤ 2.5	After environment ≤ 15 ≤ 7.5	
Voltage rating (V.R.M.R.) • Cable RG 196/U - RG 188A/U - .047" • ∅ 2.6 double screen • RG 405/U - .085	At sea level 170 V rms max 335 V rms max 250 V rms max	At 70.000 Ft 45 V rms max 85 V rms max 65 V rms max	
Dielectric withstanding voltage • Cable RG 196/U - RG 188A/U - .047" • ∅ 2.6 double screen • RG 405/U - .085	At sea level 500 V rms max 750 V rms max 750 V rms max	At 70.000 Ft 100 V rms max 100 V rms max 100 V rms max	
Power	P = 120W at 1.8 GHz, T = 40°C at sea level, VSWR = 1.1 for a straight plug MCX for [2.6/50/D cable		

MECHANICAL CHARACTERISTICS

Mechanical endurance	500 matings
Engagement Separation force	≤ 14.2 lbs - 63 N max ≥ 1.8 Lbs - 8N ≤ 4.5 lbs 20 N
Cable retention force • RG 196A/U • RG 188A/U • ∅ 2.6/50 Ω double screen • .047" • RG 405/U-.085	≥ 7.2 lbs - 32 N ≥ 11.9 lbs - 53 N ≥ 24.1 lbs - 107 N ≥ 9.7 lbs - 43 N ≥ 34.9 lbs - 155 N
Contact captivation	Axial force 2.25 Lbs 10 N

ENVIRONMENTAL CHARACTERISTICS

Operating temperature	-55°C +155°C
Temperature cycling	CECC 22220 paragraph 4-6-5
Thermal shock	CECC 22220 paragraph 4-6-7
High temperature test	CECC 22220 paragraph 4-7-2
Corrosion (salt spray)	CECC 22220 paragraph 4-6-10
Vibration	CECC 22220 paragraph 4-6-3

MATERIALS AND PLATING

	Materials	Platings
Bodies and male contacts	Brass	Gold / BBR (bodies)
Female center contacts	Beryllium copper	Gold
Ferrules	Brass	
Insulators	PTFE	

All dimensions are given in mm.
Standard packaging = 100 pieces

Plugs

STRAIGHT PLUGS, FULL CRIMP TYPE, FOR FLEXIBLE CABLES

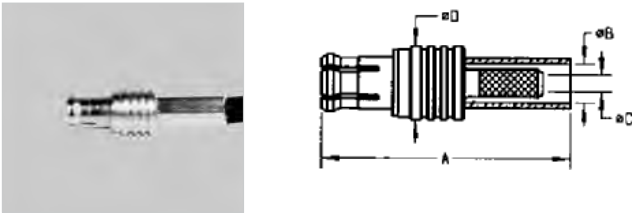

Cable group	Cable group dia.	Part number	Imp. (Ω)	Dimensions (mm)				Captive center contact	Finish
				A	B	C	D		
RG178 / RG196	2/50/S	R113 081 000	50	16.1	2.55	1.1	5	no	Gold
RG174 / RG316	2.6/50/S	R113 082 000		16.1	2.95	1.65		yes	
RD316	2.6/50/D	R113 083 000		16.2	3.25	1.65			
RG179	2.6/75/S	R213 082 007	75	18.2	2.95	1.7	5.8		BBR
RD179	2.6/75/D	R213 083 007		18.3	3.25				

STRAIGHT PLUGS, SOLDER TYPE, FOR SEMI-RIGID CABLES

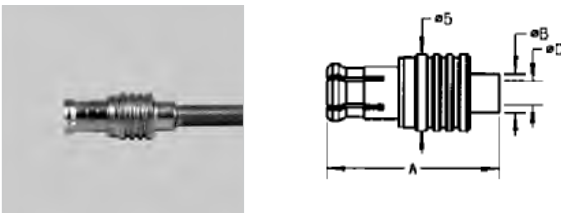

Cable group	Cable group dia.	Part number	Imp. (Ω)	Dimensions (mm)			Captive center contact	Finish
				A	B	C		
RG405	.085"	R113 053 000	50	11.3	3	2.25	no	Gold
UT085-75	.085"/75	R213 053 037	75	14.1	3.1	2.3		BBR

RIGHT ANGLE PLUGS, CRIMP TYPE, FOR FLEXIBLE CABLES (captive center contact)

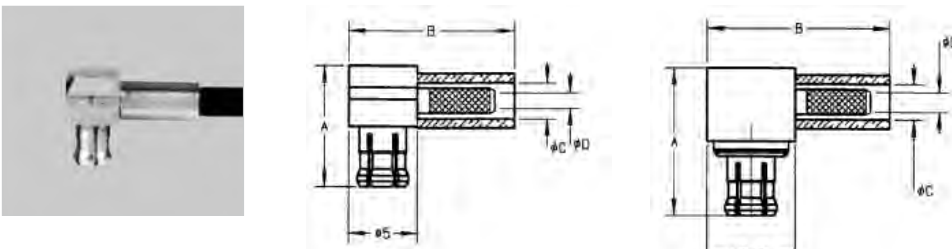

Fig. 1

Fig. 2

Cable group	Cable group dia.	Part number	Fig.	Imp. (Ω)	Dimensions (mm)				Finish
					A	B	C	D	
RG178 / RG196	2/50/S	R113 181 000	1	50	8.6	11.9	2.55	1.1	Gold
RG174 / RG316	2.6/50/S	R113 182 000					2.95	1.65	
		R113 182 020			8.2	11.1	3.1	1.7	Gold
RD316	2.6/50/D	R113 183 000			8.6	11.9	3.25	1.65	BBR
		R113 183 020							
RG179	2.6/75/S	R213 182 007	2	75	10.6	13.3	2.95	1.7	
RD179	2.6/75/D	R213 183 007					3.25		

Plugs and jacks

RIGHT ANGLE PLUGS, SOLDER TYPE (captive center contact)

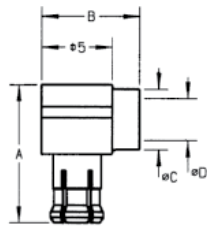

Cable group	Cable group dia.	Part number	Imp. (Ω)	Dimensions (mm)				Finish
				A	B	C	D	
.047" semi-rigid	.047"	R113 151 000	50	8.6	7	2.1	1.25	Gold
RG405	.085"	R113 153 000				3.1	2.25	
RG178 / RG174 / RG405	2/50/S - 2.6/50/S - .085"	R113 161 000		8	8	3.0	2.35	

STRAIGHT JACKS, FOR FLEXIBLE AND SEMI-RIGID CABLES

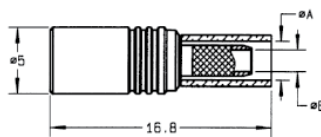

Fig. 1

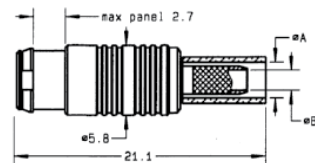

Fig. 2

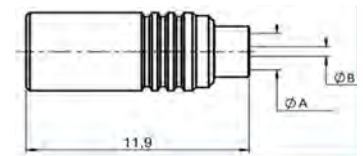

Fig. 3

Cable group	Cable group dia.	Part number	Fig.	Imp. (Ω)	Dimensions (mm)		Captive center contact	Panel drilling	Finish
					A	B			
RG174 / RG316	2.6/50/S	R113 240 000	1	50	2.95	1.65	yes	P01	Gold
RG179	2.6/75/S	R213 238 007	2	75	2.95	1.7			Clip-on panel mount
RG405	.085"	R113 223 000	3	50	2.25	0.6	no		Gold

STRAIGHT BULKHEAD JACKS, FOR FLEXIBLE AND SEMI-RIGID CABLES

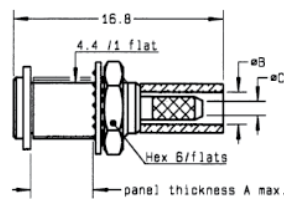

Fig. 1

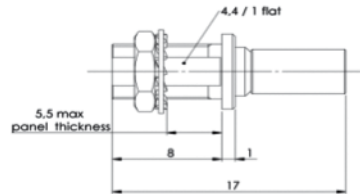

Fig. 2

Cable group	Cable group dia.	Part number	Imp. (Ω)	Dimensions (mm)			Captive center contact	Panel drilling	Finish
				A	B	C			
RG174 / RG316	2.6/50/S	R113 310 000	50	5	2.95	1.65	yes	P02	Gold
RG178 / RG196	2/50/S	R113 306 000			2.55	1.1	no		
RG405	.085"	R113 303 000			2.25	0.6			
RG174 / RG196	2.6/50/S	R113 312 000			2.95	1.65	yes		

Receptacles

STRAIGHT FEMALE PANEL RECEPTACLES (captive center contact)

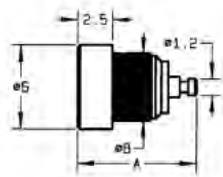

Fig. 1

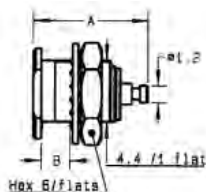
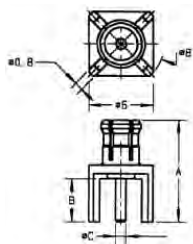

Fig. 2

Part number	Fig.	Imp. (Ω)	Dimensions (mm)		Panel drilling	Finish	Note
			A	B			
R113 402 220	1	50	8.7	4.8	P03	BBR	Press-in mount
R113 553 000	2		8.65	2.5	P02	Gold	Recessed front mount

STRAIGHT MALE PCB RECEPTACLES (captive center contact)



Part number	Imp. (Ω)	Dimensions (mm)			Panel drilling	Finish
		A	B	C		
R113 425 000	50	9.65	4.1	0.98	P04	Gold

STRAIGHT FEMALE PCB RECEPTACLES (captive center contact)

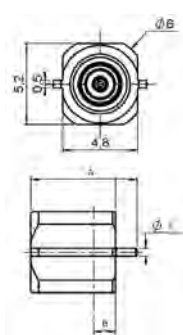

Fig. 1

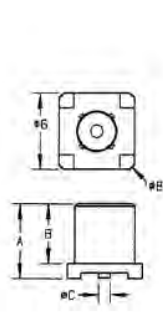

Fig. 2

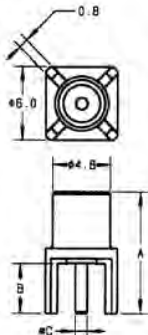

Fig. 3

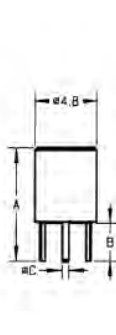

Fig. 4

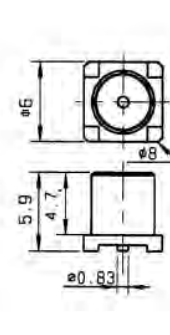
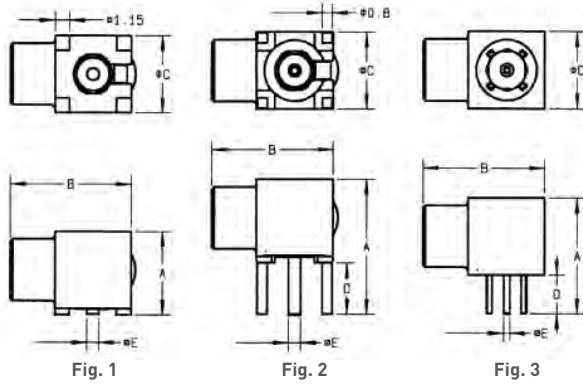

Fig. 5

Part number	Fig.	Imp. (Ω)	Dimensions (mm)			Assembly instructions	Panel drilling	Finish	Note
			A	B	C				
R113 423 000	1	50	6.9	1.4	0.5	M01	Gold	SMT / Edge-card	
R113 424 000	2		5.9	4.7	0.96			SMT	
R113 424 010								SMT / Tape & Reel 100 pieces	
R113 424 020								SMT / Tape & Reel 500 pieces	
R113 426 000	3		10	4.1	0.98			P04	Gold
R113 427 000	4	9	3	0.5	P05				
R213 424 800	5	75				SMT / Tape & Reel 100 pieces			

Receptacles and in series adapters

RIGHT ANGLE FEMALE PCB RECEPTACLES (captive center contact)



Part number	Fig.	Imp. (Ω)	Dimensions (mm)					Assembly instructions	Panel drilling	Finish	Note
			A	B	C	D	E				
R113 664 000	1	50	6.5	9.5	6	4	0.96	M01	P04	Gold	SMT
R113 665 000	2		10.5								4
R113 665 020	2		9	9.4		3	0.5	P05	Space saving pattern		
R113 666 000	3	75	6.5	9.5	6	4	0.83	M01	P04	Gold	SMT / Tape & Reel 100 pieces
R213 664 800	1		10.5								4
R213 665 000	2		10.5	4		0.83	P04				

IN SERIES ADAPTER (female - female)

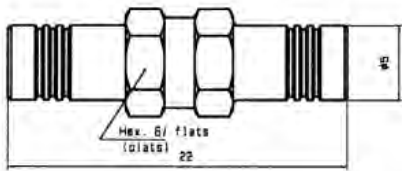

Part number	Imp. (Ω)	Finish
R113 704 000	50	Gold

Panel drilling

P01

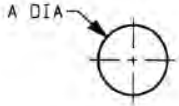

A	MM		INCH	
	maxi	mini	maxi	mini
A	5	4.97	0.197	0.196

P02

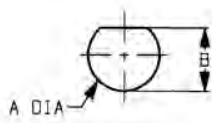

	MM		INCH	
	maxi	mini	maxi	mini
A	5	4.9	0.197	0.19
B	4.58	4.46	0.18	0.176

P03

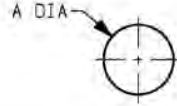

A	MM		INCH	
	maxi	mini	maxi	mini
A	4.77	4.74	0.188	0.187

P04

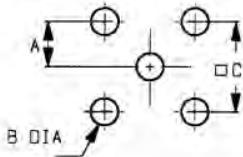

A	MM		INCH	
	maxi	mini	maxi	mini
A	2.56	2.52	0.101	0.099
B	1.4	1.3	0.055	0.051
C	5.13	5.03	0.202	0.198

P05

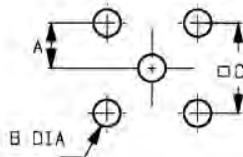

A	MM		INCH	
	maxi	mini	maxi	mini
A	1.30	1.24	.051	.049
B	0.89	0.79	.035	.031
C	2.59	2.49	.102	.098

Packaging

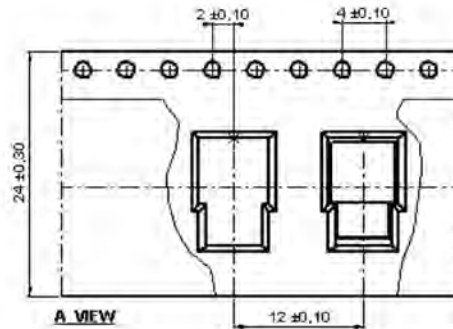
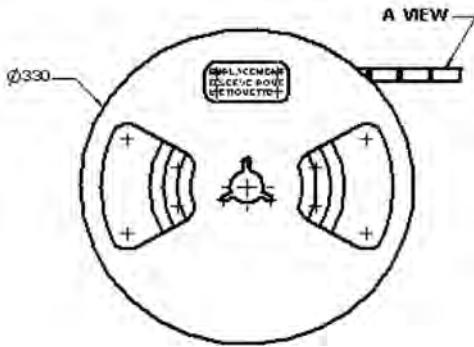

Assembly instructions

M01

Part number
R113 423 000

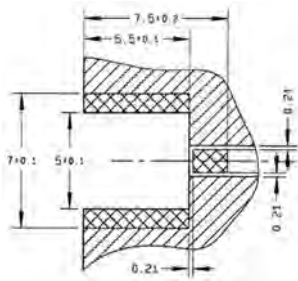

Part number	a	b	c
R113 424 000 R113 424 010 R113 424 020	R113A 424 020 R113 664 000	$\varnothing 1.7 \begin{smallmatrix} +0.1 \\ 0 \end{smallmatrix}$	1.2 0.21
R113A 664 120		$\varnothing 1.05$	1.2 0.21
R213 424 800		$\varnothing 1.57 \begin{smallmatrix} +0.1 \\ 0 \end{smallmatrix}$	1 0.63

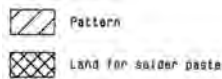
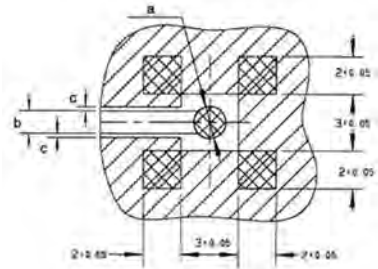

COPLANAR LINE

Pattern and signal are on the same side.
 Thickness of PCB: .063 (1.6 mm).
 The material of PCB is the epoxy resin of glass fabrics bacs (Er = 4.8).
 The solder resist should be printed.

VIDEO SHADOW

Part number
R113 423 000

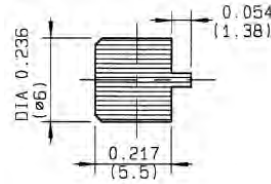

Part number
R113 424 000 R113 424 020 R113 424 010 R113A 424 020 R213 424 800

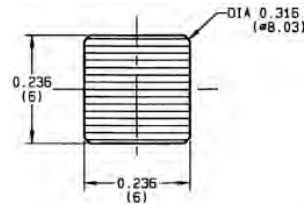

Part number
R113 664 000 R213 664 800
R113A 664 120

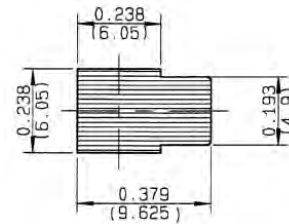

Aspiration nozzle dimensions **MCX 50Ω** **MCX 75Ω**

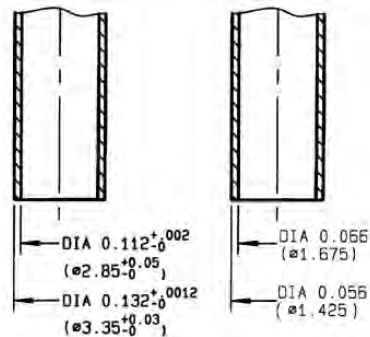



SMPM / SMP / SMP-LOCK™ / SMP-COM

R201 / R222 / R222L / R2229



Contents

SMPM

Introduction 2-4
Interface 2-5
Characteristics 2-6
Plugs and Jacks 2-7
Receptacles and panel shrouds 2-8 to 2-9
Adapters 2-9 to 2-10
Panel drilling 2-10 to 2-11
Assembly instructions 2-11

SMP

Introduction 2-4
Interface 2-12 to 2-13
Characteristics 2-14
Plugs and jacks 2-15 to 2-16
Receptacles 2-16 to 2-20
Panel shroud 2-19 to 2-20
Glass bead 2-20
Adapters 2-20 to 2-21
Packaging 2-21
Assembly instructions 2-22

SMP-LOCK™

Introduction 2-23
Plugs 2-24
Receptacles 2-24 to 2-25
Adapters and Panel drilling 2-25

SMP-COM

Introduction 2-4
Interface 2-12 to 2-13
Characteristics 2-26
Plugs 2-27
Receptacles 2-28
Adapters and Measurement PCB 2-28
Packaging 2-29
Assembly instructions 2-29

Introduction



	SMP	SMP-COM	SMPM
50Ω	DC - 40 GHz	DC - 12.4 GHz	DC - 65 GHz

GENERAL

- Small, lightweight connectors
- Snap-in, suitable for blindmate applications
- Excellent vibration and shock performances
- Allows axial and radial misalignment

APPLICATIONS

- Active array antenna
- Satellite
- Airborne / Ship / Ground radar
- Communication equipment
- High speed electro-optical devices
- Board to board applications

SMP series

Radiall SMP series meets MIL STD 348, figure 326 interface standard, and DESC specifications 94007 & 94008. They are intermateable with GPO® (Gilbert Engineering Inc.).

There are 3 levels of retention (applicable to the male connectors when ordering) which provide different levels of force required to connect and disconnect the connectors:

- Full detent for a positive locking with a maximum retention
- Limited detent for a positive locking with a medium retention
- Smooth bore for the lowest retention (slide connection)

Radiall also offers multiport solutions with SMP interface allowing better alignment control while mating multiple connectors. The multiport concept increases density and allows the operator to save installation time by connecting several SMP connectors in one operation.

SMP-COM

SMP-COM is an economically priced alternative fully intermateable with standard SMP connectors. It has been optimized to operate up to 12.4 GHz meeting the needs of telecom applications. Compared to SMP, which is primarily made of stainless steel material, SMP-COM uses brass material.

SMPM

30% smaller than SMP, SMPM connectors are designed for very high frequency applications where space and package density are a necessity.

The Radiall SMPM series meets MIL STD 348, figure 328 interface standard. They are intermateable with GPPPO® (Gilbert Engineering Inc.).

There are 2 levels of retention (applicable to the male connectors when ordering):

- Full detent for a positive locking with a maximum retention
- Smooth bore for a lower retention but higher durability (mating cycles)

Unique visual identification groove: in order to easily identify full detent connectors versus smooth bore, Radiall SMPM full detent receptacles feature a groove on the outer body. This method of identification is an innovation by Radiall.

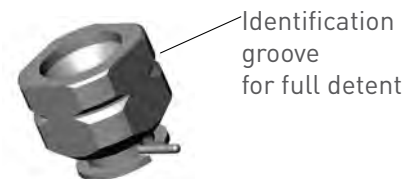

SMPM SMT receptacle

Interface SMPM

PLUG WITH FEMALE CENTER CONTACT

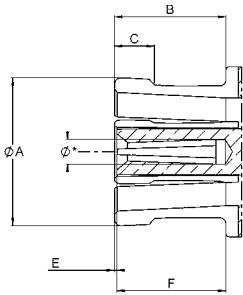

Letter	mm		inch		Note
	min.	max.	min.	max.	
A		2.41		.095	dia
B	1.73		.068		
C		0.58		.023	
E	0	0.20	0	.008	Center contact recession
F	1.27		.050		
*	Accept 0.305 +/-0.025 (.012" +/- .001) dia pin				

JACK WITH MALE CENTER CONTACT (full detent)

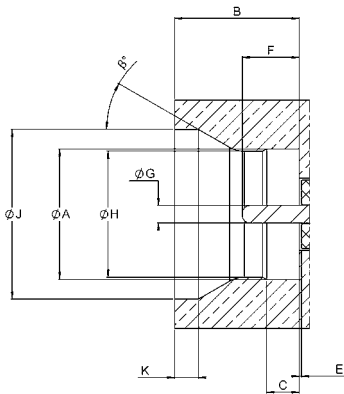

Letter	mm		inch		Note
	min.	max.	min.	max.	
A	2.18	2.24	.086	.088	dia
B	2.08	2.13	.082	.084	
C	0.53	0.58	.021	.023	
E	0	0.12	0	.004	
F	0.76	1.14	.030	.045	
G	0.28	0.33	.011	.013	dia
H	2.11	2.16	.083	.085	dia
J	2.82	2.92	.111	.115	dia
K	0.25	0.56	.010	.022	
b	25	35			degree

JACK WITH MALE CENTER CONTACT (smooth bore)

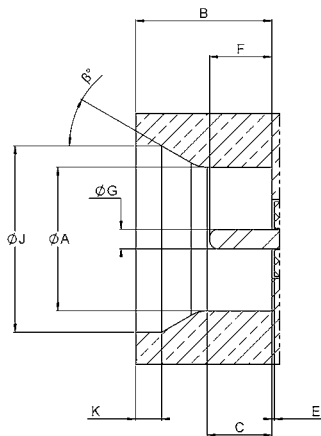

Letter	mm		inch		Note
	min.	max.	min.	max.	
A	2.18	2.24	.086	.088	dia
B	2.08	2.13	.082	.084	
E	0	0.12	0	.004	
F	0.76	1.14	.030	.045	
G	0.28	0.33	.011	.013	dia
J	2.82	2.92	.111	.115	dia
K	0.25	0.56	.010	.022	
b	25	35			degree

Characteristics

Test / Characteristics	Values / Remarks
ELECTRICAL CHARACTERISTICS	
Impedance	50Ω
Frequency range	DC - 65 GHz
V.S.W.R. • Straight styles • Right angle styles • Adapters • Hermetic receptacles	1.10 to 12GHz / 1.15 to 26GHz / 1.30 to 40GHz 1.25 to 12GHz / 1.30 to 18GHz 1.10 to 12GHz / 1.20 to 40GHz / 1.30 to 65GHz 1.15 to 18GHz / 1.35 to 40GHz
Insertion loss (dB)	0.10 × √F Max typ
Insulation resistance (MΩ)	5000
Voltage rating (V.R.M.S.)	335
Dielectric withstanding voltage (V.R.M.S.)	500
RF leakage (dB)	-80 to 3GHz / -65 from 3 to 40GHz

MECHANICAL CHARACTERISTICS

	Smooth bore	Full detent
Mechanical endurance (durability)	500	100
Engagement force (N)	18 max - 11 typ.	36 max - 20 typ.
Separation force (N)	7 min - 9 typ.	20 min - 30 typ.
Radial misalignment Axial misalignment	± 0.25 mm (.010") 0 / + 0.25 mm (.010")	
Vibration	MIL-STD 202G Method 104, test condition D	
Shock	MIL-STD 202G Method 213, test condition I	
Thermal shock	-65° C / +125° C	
Cable retention (N) • .47" • .85"	> 45 N > 200 N	
Contact captivation axial (N)	6.7	

ENVIRONMENTAL CHARACTERISTICS

Operating temperature	-65°C / +165°C
-----------------------	----------------

MATERIALS

Cable connector with female center contact	Beryllium copper
Cable connector with male center contact • Bodies • Soldering part	Stainless steel, Beryllium copper Brass
Receptacles, shrouds	stainless steel & Beryllium copper
In series adapters	Beryllium copper
Center contacts	Beryllium copper
Center contacts for glass seal	Iron nickel cobalt sealing alloy
Insulators	Peek / PTFE

PLATING

Cable connector with female center contact	Gold
Cable connector with male center contact • Bodies • Soldering part	Passivated Gold
Receptacles, shrouds	Passivated
Center contacts	Gold

Plugs and jacks

STRAIGHT PLUGS, SOLDER TYPE FOR SEMI-RIGID CABLES

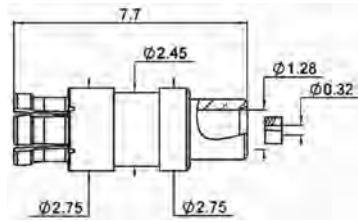

Fig. 1

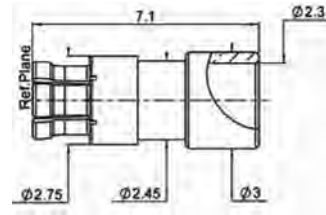

Fig. 2

Cable group	Cable group dia.	Part number	Fig.	Captive Center contact	Finish
.047" semi-rigid	.047"	R201 051 000	1	yes	Gold
RG405	.085"	R201 052 000	2		

RIGHT ANGLE PLUGS, FOR SEMI-RIGID AND FLEXIBLE CABLES

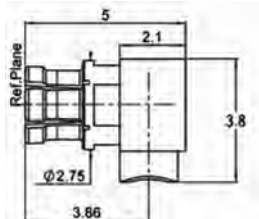

Fig. 1

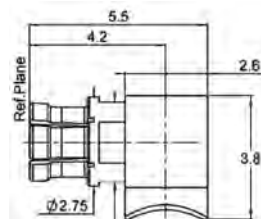

Fig. 2

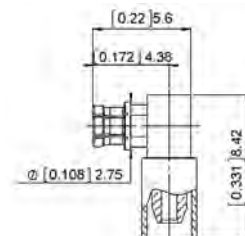

Fig. 3

Cable group	Cable group dia.	Part number	Fig.	Captive Center contact	Finish
.047" semi-rigid	.047"	R201 151 000	1	yes	Gold
RG405	.085"	R201 152 000	2		
RG178 / RG196	2/50S	R201 170 110	3		

JACK, SOLDER TYPE FOR SEMI-RIGID CABLES

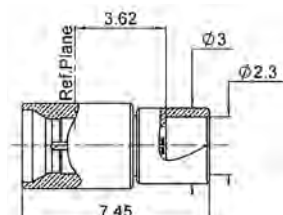

Fig. 1

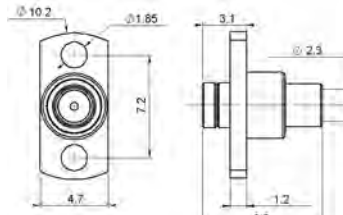

Fig. 2

Cable group	Cable group dia.	Part number	Fig.	Captive Center contact	Retention	Finish
RG405	.085"	R201 223 100	2	yes	Full detent	Gold
		R201 223 700	1		Smooth bore	
		R201 223 710	2			

Receptacles

PCB STRAIGHT RECEPTACLES (with male center contact)

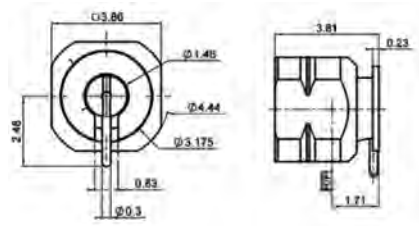

Fig. 1

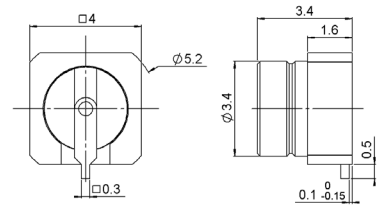

Fig. 2

Part number	Fig.	Retention	Assembly instructions	Finish	Note	Packaging
R201 508 000	1	Full detent	M01	Gold	surface mount	100
R201 508 040	2			NPGR	low profile	Tape & Reel 500 pieces
R201 508 700	1	Smooth bore		Gold	surface mount	100

PCB RECEPTACLE, EDGE CARD MOUNT (with male center contact)

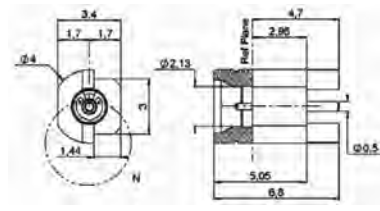
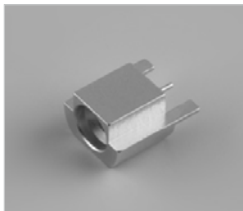

Fig. 1

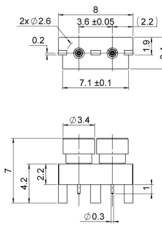

Fig. 2

Part number	Fig.	Retention	Assembly instructions	Finish	Packaging	Note
R201 423 110	1	Full detent	M02	Gold	100	
R201 423 200	2		Smooth bore	M03	NPGR	Tape & Reel 500 pieces
R201 423 700						

PANEL STRAIGHT HERMETIC RECEPTACLE, SOLDER MOUNT (with male center contact)

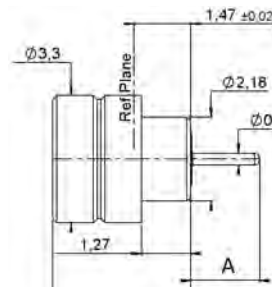

Fig. 1

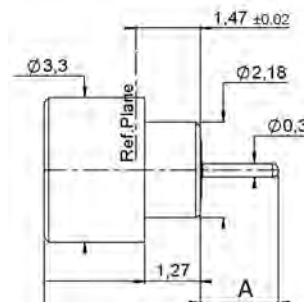

Fig. 2

Part number	Fig.	Dimension A (mm)	Retention	Panel drilling	Finish
R201 645 000	1	1.78	Full detent	P02	Gold
R201 645 020		2.28			
R201 645 700	2	1.78	Smooth bore		
R201 645 710		2.28			
R201 645 720		0.76			

Receptacles, panel shroud and adapters

THREAD-IN RECEPTACLES (with male center contact)

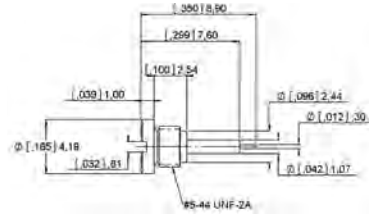
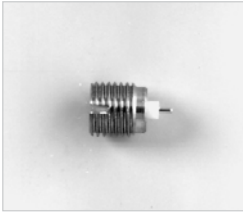

Fig. 1

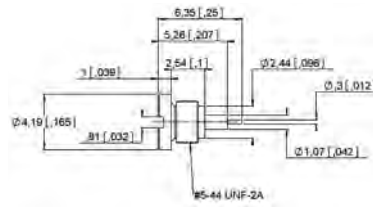
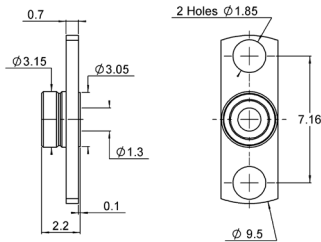
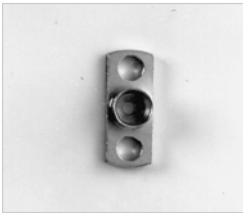

Fig. 2

Part number	Fig.	Retention	Panel drilling	Finish
R201 561 021	1	Full detent	P03	Passivated
R201 561 721	2	Smooth bore		

PANEL SHROUD, 2 HOLES FLANGE MOUNT (no center contact)



Part number	Retention	Panel drilling	Finish
R201 450 001	Full detent	P01	Passivated
R201 450 701	Smooth bore		

Note:

We recommend using Radiall glass bead R280 760 050. Glass beads can be found in Chapter 17 - Tooling & Accessories.

IN SERIES ADAPTERS (female to female center contact)

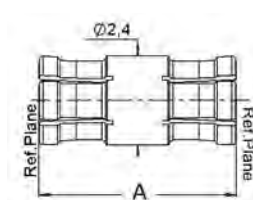

Fig. 1

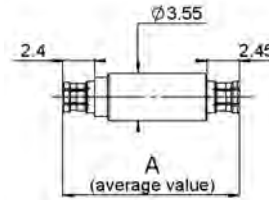

Fig. 2

Part number	Fig.	Dimension A	Type	Finish
R201 705 000	1	5.33 (.210)	Fixed length	Gold
R201 705 110		8.5 (.330)		NPGR
R201 705 120		5.33 (.210)		
R201 723 1_0	2	Consult us	Spring loaded	Gold

Adapters

BETWEEN SERIES ADAPTERS, DC-40 GHz

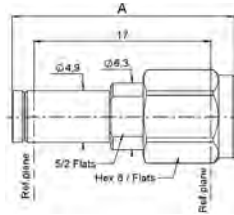

Fig. 1

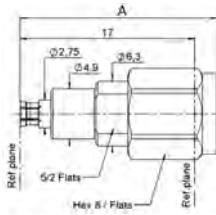

Fig. 2

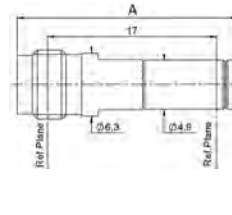

Fig. 3

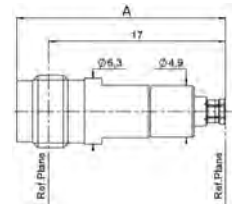

Fig. 4

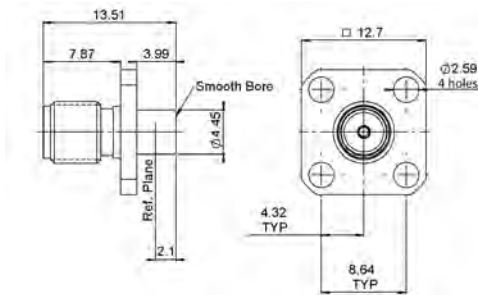

Fig. 5

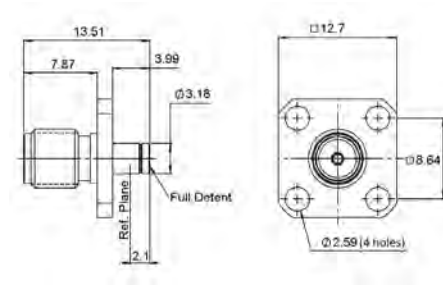

Fig. 6

Part number	Fig.	Dimension A	Description	Finish	Packaging
R191 562 000	1	21.4	SMPM male full detent / 2.4 mm male	Gold	Unit
R191 563 000	2	19.27	SMPM female / 2.4 mm male		
R191 564 000	3	22.15	SMPM male full detent / 2.4 mm female		
R191 565 000	4	20.05	SMPM female / 2.4 mm female		
5964-9513-001	5		SMPM male smooth bore / SMA female	Passivated	
5965-9513-000	6		SMPM male full detent / SMA female		
R191 956 020	1	17	SMPM male smooth bore / SMA2.9 male	Gold	
R191 957 000	2	17	SMPM female / SMA2.9 male		
R191 958 000	3	18	SMPM male full detent / SMA2.9 female		
R191 958 020	3	18	SMPM male smooth bore / SMA2.9 female		
R191 959 000	4	18	SMPM female / SMA2.9 female		

All 2.4 mm adapters feature identical electrical lengths.

Panel drilling

PANEL CUT OUT

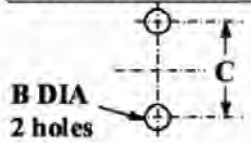

P01	
B	1.8 - 1.9 (.071 - .075)
C	7.11 - 7.21 (.0280 - .284)

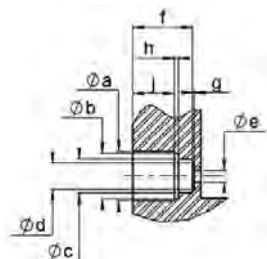

P02	
a	3.36 - 3.38
b	3.03 - 3.15
c	2.27 - 2.29
d	1.63 - 1.73
e	0.79 - 0.83
f	4.52 - 4.56
g	0.13 - 0.17
h	0.28 - 0.38
j	3.15 - 3.19

Panel drilling

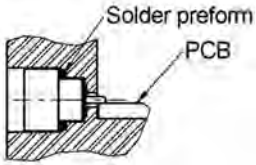

1. Degrease and clean connector and box.
2. Solder the connector on the panel. We advise using SnAg4 Cu0.5 and a low residue flux. Preheating at 100°C is recommended. Take care not to exceed 260°C during soldering operation.
3. Solder the pin on the track. We advise using SnAg4 Cu0.5 and a low residue flux. Preheating at 100°C is recommended for ceramic substrate. Take care not to exceed 260°C during soldering operation.

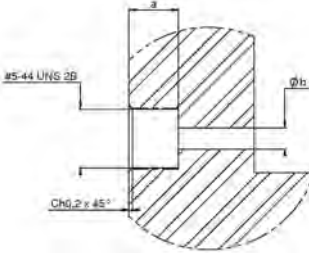

P03	
a	5.31 - 5.33
b	1.09 - 1.12

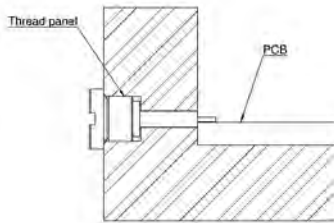

1. Degrease and clean connector and box
2. Screw-on the connector on the panel
3. Solder the pin on the track

Assembly instructions

M01

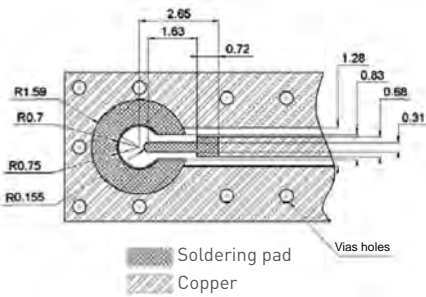

Connectors
R201 508 000
R201 508 700

Valid for RT DUROID 5880 type PCB, thickness 0.254mm, with copper layer 35µm on both sides. Add between both sides along upper ground plane according to engineering practices.

M02

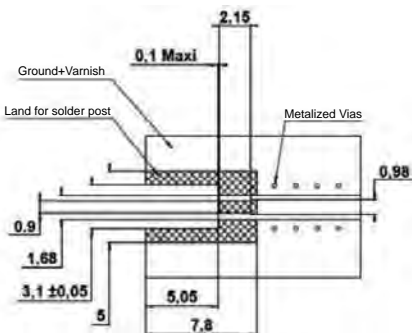

Connectors
R201 423 110

M03

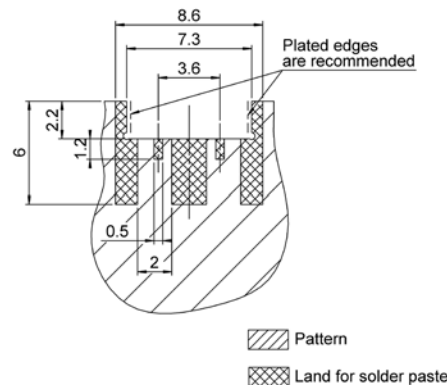

Interface SMP

JACK WITH MALE CENTER CONTACT (full detent or limited detent)

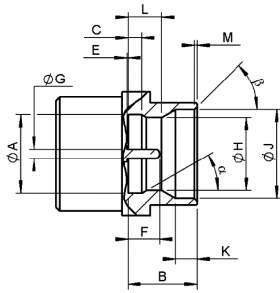

Letter	mm		inch		Note
	min.	max.	min.	max.	
A	3.15	3.20	.124	.126	Dia
B	2.74	2.84	.108	.112	
C	0.52	0.60	.0205	.0235	
E	0.00		0		Center contact recession
F	1.14	1.40	.045	.055	
G	0.36	0.41	.014	.016	Dia
H	2.90	3.00	.114	.118	Dia: Full detent
	3.00	3.10	.118	.122	Dia: Limited detent
J	3.53	3.68	.139	.145	Dia
K	0.84	0.94	.033	.037	
L	1.30	1.45	.051	.057	Full detent
	1.37	1.52	.054	.060	Limited detent
M	0.08	0.20	.003	.008	
a	30				Degree (nom.)
b	40	50	40	50	Degree

JACK WITH MALE CENTER CONTACT (smooth bore)

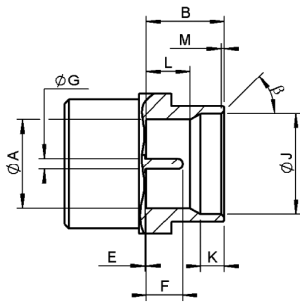

Letter	mm		inch		Note
	min.	max.	min.	max.	
A	3.12	3.23	.123	.127	Dia
B	2.74	2.84	.108	.112	
E	0.00		0		Center contact recession
F	1.14	1.40	.045	.055	
G	0.36	0.41	.014	.016	Dia
J	3.53	3.68	.139	.145	Dia
K	0.84	0.94	.033	.037	
L	1.50	1.65	.059	.065	
M	0.08	0.20	.003	.008	
b	40	50	40	50	Degree

PLUG WITH FEMALE CENTER CONTACT AND EMI SHIELD (cabled connection)

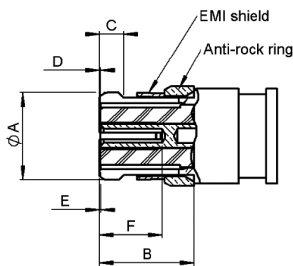

* Accept .015 ±.001 dia pin

Letter	mm		inch		Note
	min.	max.	min.	max.	
A		3.43		.135	Dia
B	2.84		.112		
C	0.46	0.64	.018	.025	
D		0.00		0	Dielectric projection
E	0.00	0.20	0	.008	Center contact recession
F	1.78		0.70		

PLUG WITH FEMALE CENTER CONTACT (cabled connection)

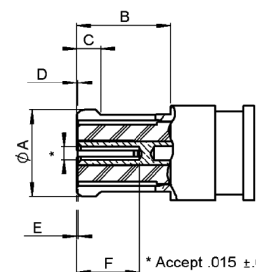

Letter	mm		inch		Note
	min.	max.	min.	max.	
A		3.43		.135	Dia
B	2.84		.112		
C	0.46	0.64	.018	.025	
D		0.00		0	Dielectric projection
E	0.00	0.20	0	.008	Center contact recession
F	1.78		0.70		

Interface SMP

JACK WITH MALE CENTER CONTACT (catcher's mitt)

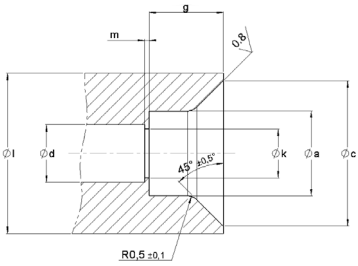

Letter	mm		inch		Note
	min.	max.	min.	max.	
A	3.12	3.23	.123	.127	Dia
C	5.40	5.50	.213	.217	Dia
D	0.37	0.39	.0146	.0154	Dia
F	1.10	1.18	.043	.046	
G	2.77	2.81	.109	.111	
K	0.00		0		Center contact recess
L	0.00		0		Insulator recess
M	1.15	1.39	.045	.055	

Note:
Catcher's Mitt interface is not defined in MIL-STD-348 standard.

Interface SMP-COM

MALE CONNECTOR (full detent or limited detent)

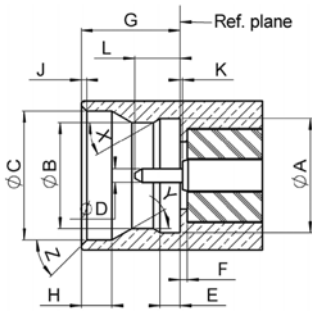

Dia A	3.18+/-0.02
Dia B (Full detent)	2.95+/-0.02
Dia B (Limited detent)	3.05+/-0.02
Dia C	3.59 +/-0.02
Dia D	0.38+/-0.02
E	0.56+/-0.03
F	0.2+/-0.025
G (Full detent)	2.79+/-0.02
G (Limited detent)	2.77+/-0.02
H	0.86+/-0.02
J	0.15+/-0.05
K	0.07+/-0.07
L	1.27+/-0.12
X	30°+/-0.5°
Y	30°+/-0.5°
Z	45° nom

MALE CONNECTOR (smooth bore)

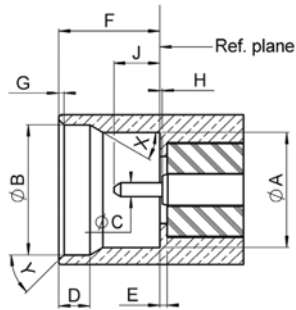

Dia A	3.18+/-0.02
Dia B	3.59+/-0.02
Dia C	0.38+/-0.02
D	0.86+/-0.02
E	0.2+/-0.025
F	2.79+/-0.02
G	0.15+/-0.05
H	0.07+/-0.07
J	1.27+/-0.12
X	30°+/-0.5°
Y	45° nom

FEMALE CONNECTOR

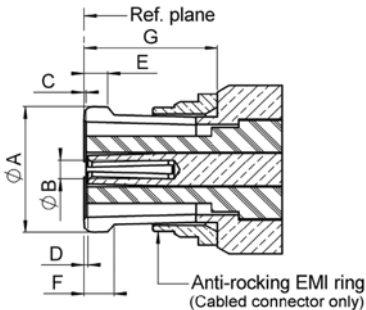

Dia A	3.275+/-0.025
Dia B	0.49+/-0.02
C	0.05+/-0.05
D	0.05+/-0.05
E	0.59+/-0.02
F	0.76+/-0.1
G	3.4+/-0.03

Characteristics

Test / Characteristics	Values / Remarks
------------------------	------------------

ELECTRICAL CHARACTERISTICS

Impedance	50Ω		
Frequency range	DC - 40 GHz		
Typical V.S.W.R.	DC-12 GHz	12-26.5 GHz	26.5-40 GHz
• Straight styles	1.15	1.15	1.5
• Right angle styles	1.25	1.35	-
• Adapters	1.10	1.15	1.5
• Receptacles	1.30	-	-
Insertion loss (dB)	0.12 vF (F in GHz)		
Insulation resistance (MΩ)	5000		
Voltage rating (V.R.M.S.)	335		
Dielectric withstanding voltage (V.R.M.S.)	500		
RF leakage	-80 dB to 3 GHz / -65 dB from 3 to 26.5 GHz - 100 dB DC to 18 GHz		
• Standard plugs			
• Plug with EMI gasket			

MECHANICAL CHARACTERISTICS

	Smooth bore	Limited detent	Full detent
Mechanical endurance (matings)	1000	500	100
Engagement and separation force (N)	9 max. - 2.2 min.	45 max. - 9 min.	68 max. - 22 min.
Radial misalignment Axial misalignment	± 0.25 mm (± .010") 0, + 0.25 mm (0/ .010")		
Vibration	MIL-STD-202 method 204, test condition D		
Shock	MIL-STD-202 method 213, test condition I		
Thermal shock	MIL-STD-202 method 107, test condition B		
Cable retention (N)			
• .047"	45		
• .085"	200		
Contact captivation axial (N)	6.8		

ENVIRONMENTAL CHARACTERISTICS

Operating temperature	-65°C / +165°C
-----------------------	----------------

MATERIALS

Cable connector with female center contact	Beryllium copper
Cable connector with male center contact	
• Bodies	Stainless steel
• Soldering part	Brass
Receptacles, shrouds	Stainless steel
In series adapters	Beryllium copper
Center contacts	Beryllium copper
Center contacts for glass seal	Iron nickel cobalt sealing alloy
Insulators	PTFE

PLATING

Cable connector with female center contact	Gold
Cable connector with male center contact	
• Bodies	Passivated
• Soldering part	Gold
Receptacles, shrouds	Passivated
In series adapters	Gold
Center contacts	Gold

Plugs and jacks

PLUG, SOLDER TYPE FOR SEMI-RIGID CABLES (with female center contact)

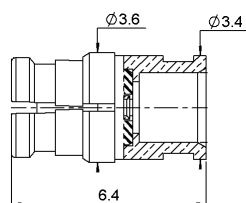

Fig. 1

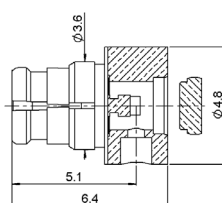

Fig. 2

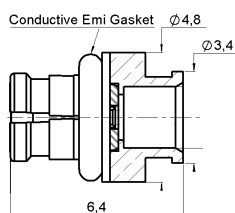

Fig. 3

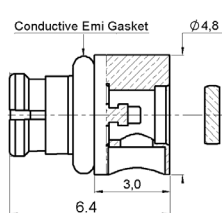

Fig. 4

Cable group	Cable group dia.	Part number	Fig.	Captive center contact	Orientation	Finish	Note
.047" semi-rigid	.047"	R222 051 000	1	no	Straight	Gold	With EMI gasket low RF leakage
RG405	.085"	R222 052 000					
.085" micro-porous	.085"	R222 052 300	2	yes	Right angle		
.047" semi-rigid	.047"	R222 151 000					
RG405	.085"	R222 152 000	3	no	Straight		
		R222 062 100					
		R222 162 100	4	yes	Right angle		

STRAIGHT JACK, SOLDER TYPE FOR SEMI RIGID CABLES (with male center contact)

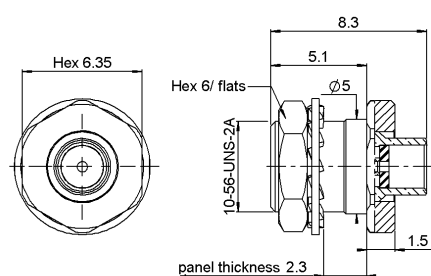

Fig. 1

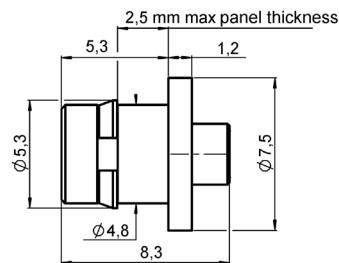
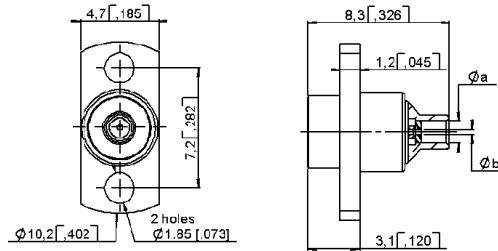
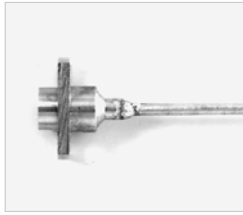

Fig. 2

Cable group	Cable group dia.	Part number	Retention	Fig.	Note	Captive center contact	Panel drilling	Finish
RG405	.085"	R222 302 002	Full detent	1	Bulkhead feedthrough	no	P05	Passivated + Gold (soldering part)
		R222 302 302	Limited detent					
		R222 302 702	Smooth bore					
		R222 223 002	Full detent	2	Snap-in		P08	
		R222 223 302	Limited detent					
		R222 223 702	Smooth bore					

Jacks and receptacles

**TWO HOLE FLANGE JACK SOLDER TYPE FOR SEMI RIGID CABLES
(with male center contact)**



Cable group	Cable group dia.	Part number	Retention	Dimensions mm (inch)		Captive center contact	Panel drilling	Finish
				ϕa	ϕb			
RG405	.085"	R222 252 001	Full detent	2.30 [.091]	0.60 [.024]	no	P01	Passivated + Gold (soldering part)
		R222 252 301	Limited detent					
		R222 252 702	Smooth bore					

PCB STRAIGHT RECEPTACLE, 4 SOLDER LEGS (with male center contact)

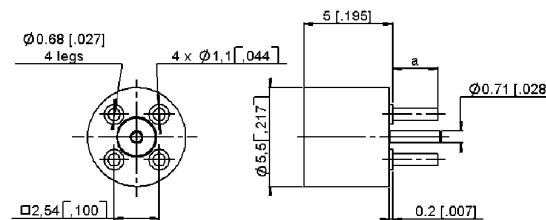

Part number	Retention	Dimensions mm (inch)	PCB mounting	Finish
		a		
R222 426 000	Full detent	2.5 [.098]	P03	Gold
R222 426 300	Limited detent			
R222 426 700	Smooth bore			
R222 426 020	Full detent	3.6 [.142]		
R222 426 320	Limited detent			
R222 426 720	Smooth bore			

MICROSTRIP RECEPTACLE, EDGE CARD MOUNT

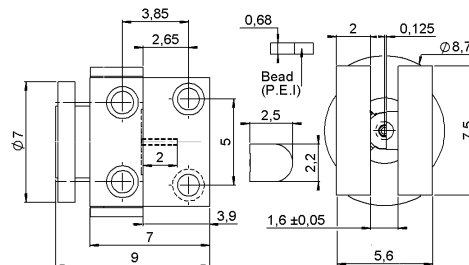

Part number	Retention	Finish	Assembly instructions	Note
R222 423 041	Full detent	Passivated	See technical data sheet	Supplied with dielectric bead

Receptacles

PCB STRAIGHT RECEPTACLE, SURFACE MOUNT (with male center contact)

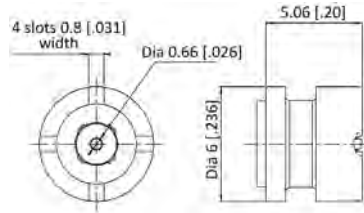

Fig. 1

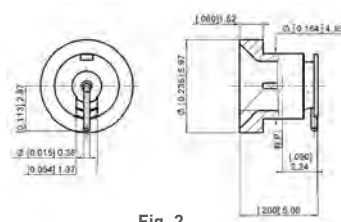

Fig. 2

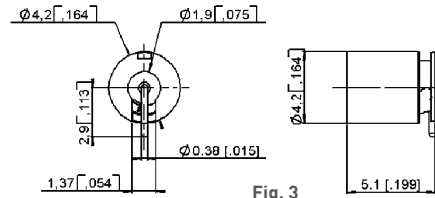

Fig. 3

Part number	Fig.	Retention	Assembly instructions	Finish	Packaging
R222 408 350	1	Limited detent	M04	Gold	Tape & Reel 500 pieces
R222 408 750		Smooth bore			Tray 100 pieces
R222 508 000	3	Full detent	M03	Passivated + Gold (soldering area)	Tape & Reel 500 pieces
R222 508 300		Limited detent			
R222 508 700		Smooth bore			
R222 508 722	2	Catcher's mitt			

PCB RECEPTACLE, EDGE CARD MOUNT (with male center contact)

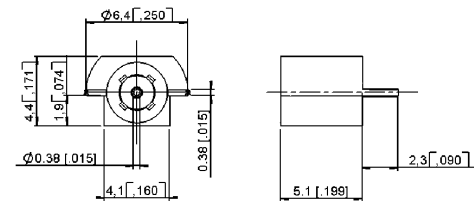
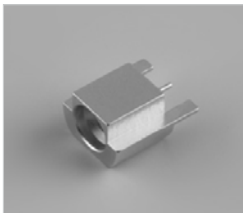

Fig. 1

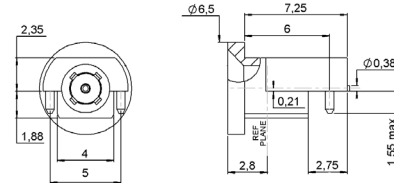
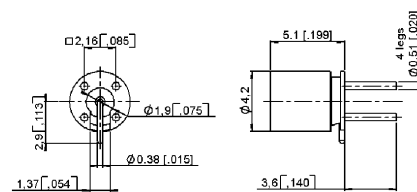

Fig. 2

Part number	Retention	Fig.	Assembly instructions	Finish	Packaging
R222 423 023	Full detent	1	M01	Gold	Tape & Reel 500 pieces
R222 423 320	Limited detent				
R222 423 720	Smooth bore				
R222 680 710	Catcher's mitt	2	M05		

PCB STRAIGHT RECEPTACLE, PIN & PASTE MOUNT (with male center contact)



Part number	Fig.	Retention	Assembly instructions	Finish
R222 428 000	1	Full detent	M02	Passivated + Gold (soldering part)
R222 428 300		Limited detent		
R222 428 700		Smooth bore		

Receptacles

PCB RIGHT ANGLE RECEPTACLE, 4 SOLDER LEGS (with male center contact)

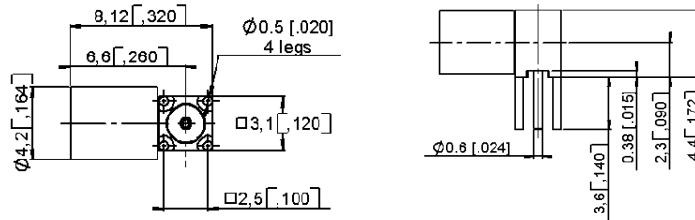

Part number	Retention	PCB mounting	Finish
R222 680 000	Full detent	P04	Passivated + Gold (soldering part)
R222 680 300	Limited detent		
R222 680 700	Smooth bore		

SQUARE FLANGE RECEPTACLES

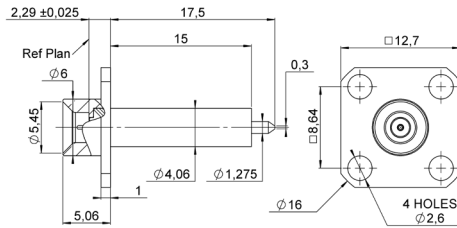

Fig. 1

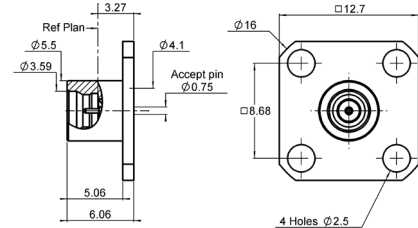
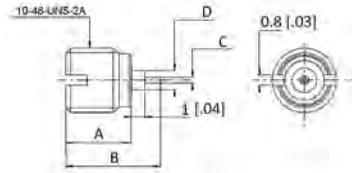
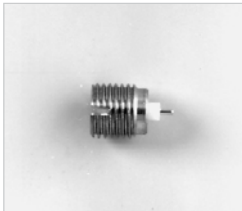

Fig. 2

Part number	Retention	Fig.	Captive center contact	Panel drilling	Finish
R222 414 711	Limited detent	1	yes	P07	Passivated
R222 411 001	Full detent	2			

THREAD-IN RECEPTACLE (with male center contact)



Part number	Retention	Dimensions mm (inch)				Finish
		A	B	C	D	
R222 561 001	Full detent	4.8 (.191)	7.1 (.278)	0.46 (.018)	1.45 (.057)	Passivated
R222 561 301	Limited detent					
R222 561 701	Smooth bore					
R222 561 331	Limited detent	6.2 (.243)	8.3 (.326) +/-0.5 with sliding pin R280 473 1X0	1.0 (.04)		

Receptacles and panel shroud

PANEL STRAIGHT HERMETIC RECEPTACLE, SOLDER MOUNT (with male center contact)

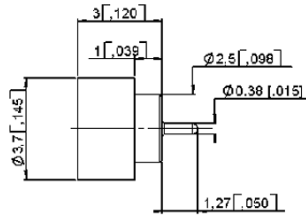
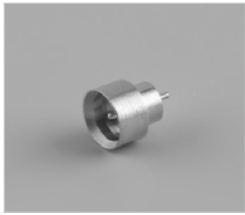

Fig. 1

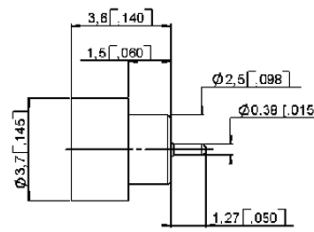
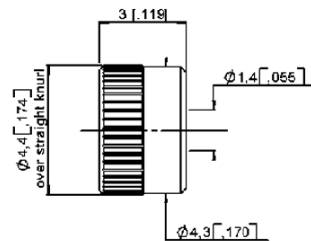

Fig. 2

Part number	Retention	Fig.	Finish	Note
R222 645 020	Full detent	1	Gold	short body 1mm glass seal
R222 645 320	Limited detent			
R222 645 000	Full detent	2		
R222 645 300	Limited detent			
R222 645 700	Smooth bore			1.5mm glass seal

Other dimensions available, please consult us.

PANEL SHROUD, PRESS-IN MOUNT (no center contact)



Part number	Retention	Panel drilling	Finish
R222 402 021	Full detent	P06	Passivated
R222 402 321	Limited detent		
R222 402 721	Smooth bore		

This shroud is designed to be used with hermetic glass seal R280 752 000 (see next page).

PANEL SHROUD, 2 HOLES FLANGE MOUNT (no center contact)

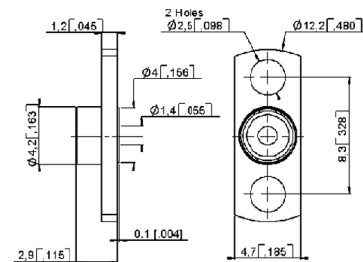

Part number	Retention	Panel drilling	Finish
R222 450 001	Full detent	P02	Passivated

This shroud is designed to be used with hermetic glass bead R280 752 000 - more glass beads can be found in Chapter 17 - Tooling & Accessories.

Panel shroud, glass bead and adapters

PANEL SHROUD, THREAD-IN MOUNT (no center contact)

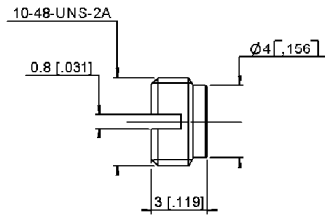

Part number	Retention	Finish
R222 550 001	Full detent	Passivated
R222 550 301	Limited detent	
R222 550 701	Smooth bore	

This shroud is designed to be used with hermetic glass seal R280 752 000

HERMETIC GLASS BEAD

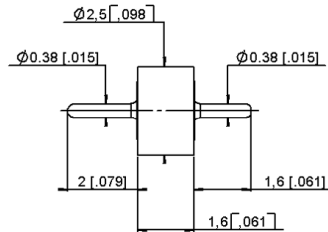

Part number
R280 752 000

More glass beads can be found in Chapter 17 - Tooling & Accessories.

IN SERIES ADAPTERS (female to female center contact)

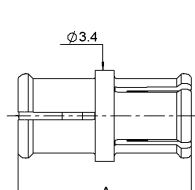

Fig. 1



Fig. 2

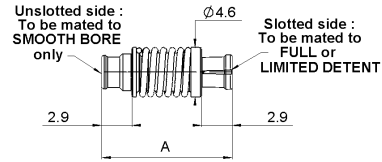

Fig. 3

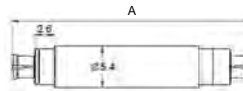

Fig. 4

Part number	Fig.	Dimensions A mm (inch)	Type	Finish
R222 705 000	1	6.45 (.254)	Fixed length	Gold
R222 705 200		5.7 (.224)		
R222 705 220		10.3 (.405)		
R222 705 239		10.0 (.395)		
R222 705 320		36.3 (1.43)		
R222 705 380		26.9 (1.06)		
R222 705 340		24.6 (.969)		
R222 705 210		14.2 (.559)		
R222 705 370		13.2 (.520)		
R222 705 250		12.6 (.496)		
R222 705 360		7.2 (.283)		
R222 705 400		2		
R222 723 110	3	min 11.71 (.461) max 12.88 (.507)	Spring loaded axial travel 1.17mm (.046")	
R222 723 120		min 17.65 (.695) max 18.82 (.741)		
R222 723 140	4	min 31.3 (1.23) max 37.3 (1.47)	Spring loaded axial travel 6.0mm (.236")	

Note:
Use removal tool R282 918 120 with SMP in series adapters.

Contact us for self aligning options in board to board or module to module applications.

Adapters

BETWEEN SERIES ADAPTERS

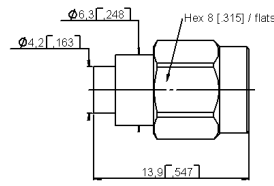
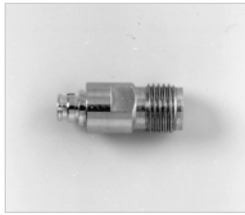

Fig. 1

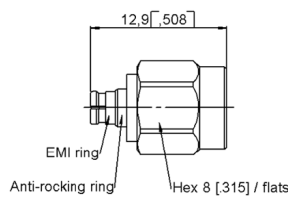

Fig. 2

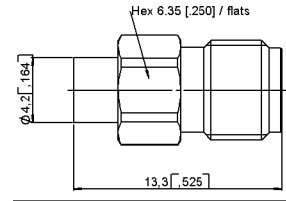

Fig. 3

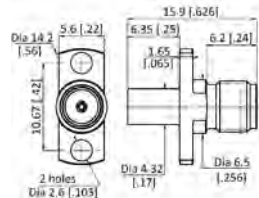

Fig. 4

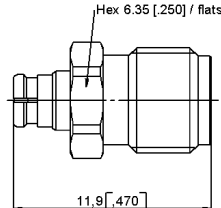

Fig. 5

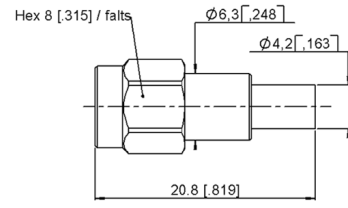

Fig. 6

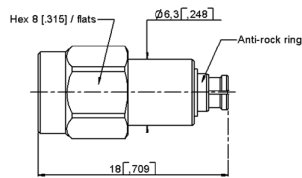

Fig. 7

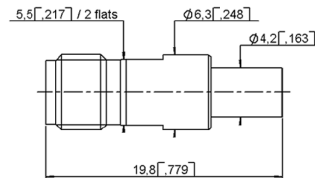

Fig. 8

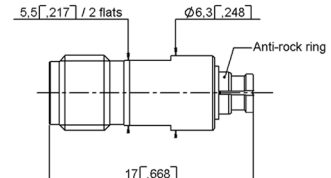
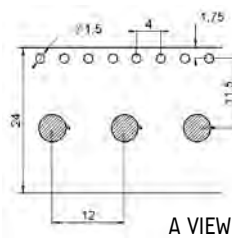
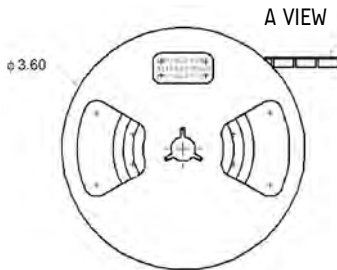

Fig. 9

Part number	Fig.	Description	Captive center contact	Finish	Packaging
R191 841 001	1	SMA male / SMP male full detent	yes	Passivated	100
R191 842 002	2	SMA male / SMP female		Passivated / Gold	
R191 843 001	3	SMA female / SMP male full detent		Passivated	
R191 843 409	4	SMA female / SMP male smooth bore		Passivated / Gold	
R191 843 429		SMA female / SMP male full detent			
R191 844 002	5	SMA female / SMP female		Passivated	100
R191 966 001	6	SMA2.9 male / SMP male full detent		Passivated / Gold	
R191 967 002	7	SMA2.9 male / SMP female		Passivated	
R191 968 001	8	SMA2.9 female / SMP male full detent		Passivated / Gold	
R191 969 002	9	SMA2.9 female / SMP female	Passivated		
			Passivated / Gold		

Packaging



Connectors	Packaging
R222 508 000	Tape & Reel 500 pieces
R222 508 300	
R222 508 700	
R222 508 722	
R222 680 710	

Assembly instructions

M01

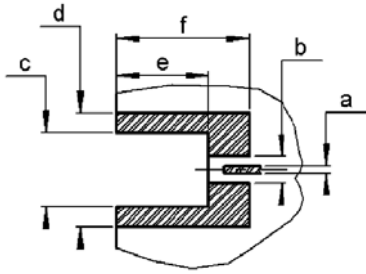

Connectors	
R222 423 023 R222 423 320	R222 423 720

PCB mounting pattern

a	0.48
b	1.5
c	4.18 - 4.32
d	6.5
e	4.95 - 5.45
f	7.52

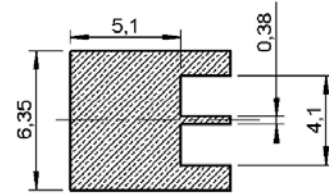

Shadow of receptacle for video camera

M02

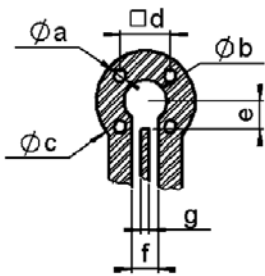

Connectors	
R222 428 000 R222 428 300	R222 428 700

PCB mounting pattern

a	0.63
b	1.90
c	4.45 min.
d	2.16
e	2.29 max.
f	1.52 max.
g	0.45 min.

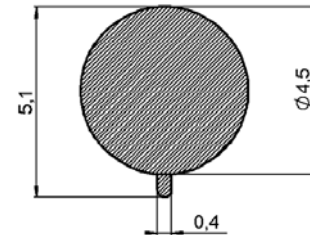

Shadow of receptacle for video camera

M03

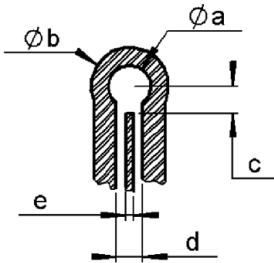

Connectors	
R222 508 000 R222 508 300	R222 508 700 R222 508 722

PCB mounting pattern

a	1.91
b	4.45 min.
c	2.29 min.
d	1.52
e	0.38 max.

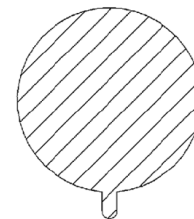

Shadow of receptacle for video camera

M04

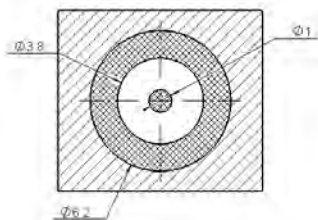

Connectors	
R222 408 350	R222 408 750

PCB mounting pattern

M05

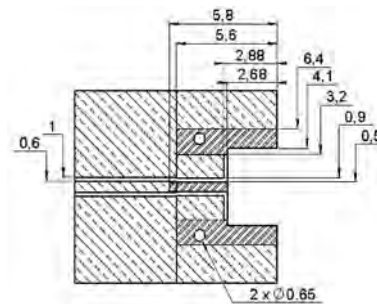

Connectors	
R222 680 710	

Introduction

SMP-LOCK™, the Ultimate Secure Connection

Radiall has expanded its broad range of SMP products with SMP-LOCK™ connectors featuring a robust locking mechanism, which dramatically increases the retention force of the interface and prevents accidental disconnection.

They have been specially designed for harsh environments and to withstand more severe vibration and drop tests.

SMP-LOCK™ connectors are suitable for cable-to-cable or cable-to-module interconnections inside equipment subject to harsh mechanical stress such as airborne radars, avionics, satellites, missile, UAV and UGV applications.

Features & benefits

- Excellent electrical performances combined with robust locking feature
- Two step connection, low insertion force
- Audible click indicates that plug is locked, eliminating accidental disconnections
- Locking sleeve provides greater retention force more than 450 N with RG-405 cable
- SMP interface has a high frequency DC-40 GHz
- Plug equipped with EMI ring offers improved RF leakage performance -92dB at 18 GHz
- SMP-LOCK™ uses limited detent interface for lower connect/disconnect forces, less mechanical stress and a longer life cycle
- Extraction tool available for easy unmating in high density panels
- IP67 rating when mated

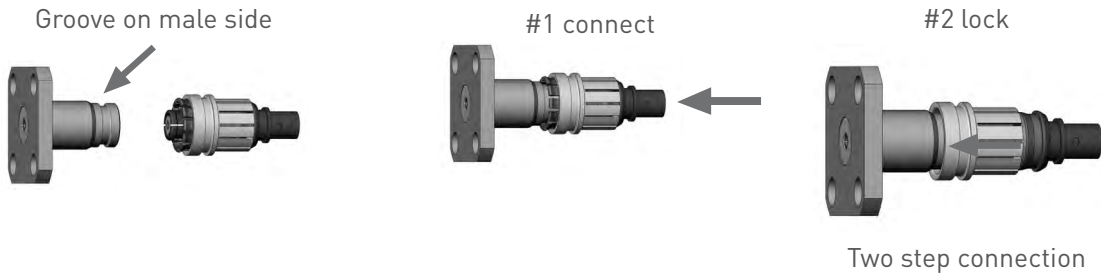

Plugs and receptacles

FEMALE PLUGS, SOLDER TYPE FOR SEMI-RIGID CABLE

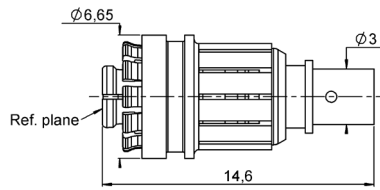

Fig. 1

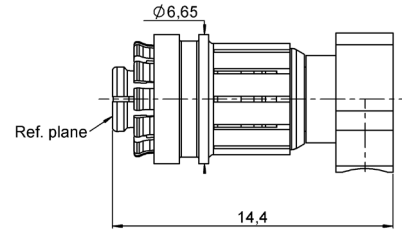
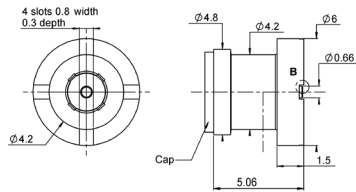

Fig. 2

Cable group	Cable group dia.	Part number	Fig.	Finish	Captive center contact	Geometry
RG405	.085"	R222 L80 010	1	Nickel + Gold	no	Straight
		R222 L80 300	2		yes	Right angle

STRAIGHT MALE SMT RECEPTACLE



Part number	Body & finish	Captive center contact
R222 L00 010	Brass, N2PGR	yes

STRAIGHT AND RIGHT ANGLE MALE PCB RECEPTACLE

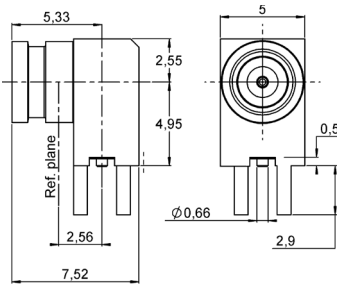

Fig. 1

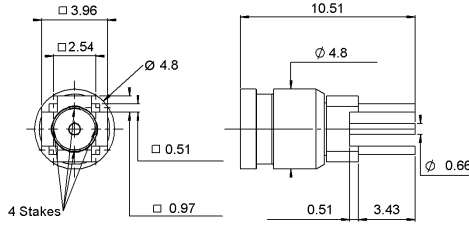

Fig. 2

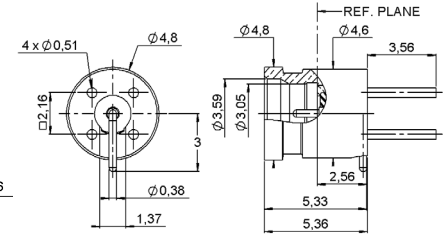
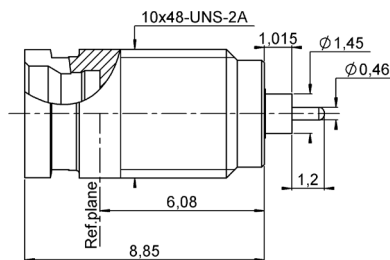

Fig. 3

Part number	Fig.	Panel drilling	Body & finish	Captive center contact
R222 L00 000	1	P01	Brass, N2PGR	yes
R222 L00 020	2	P06	Brass, Gold	
R222 L00 040	3			

SCREW-ON MALE RECEPTACLE



Part number	Panel drilling	Body & finish	Captive center contact	Contact type
R222 L10 001	P02	Stainless steel passivated	yes	Cylindrical

Receptacles and adapters

HERMETIC SCREW-ON MALE RECEPTACLE

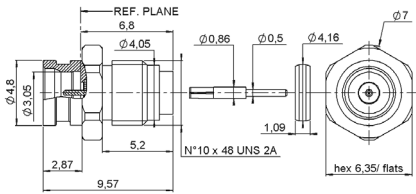

Part number	Panel drilling	Body & finish	Captive center contact	Contact type
R222 L10 040	P07	Stainless steel passivated	yes	Cylindrical

NARROW AND SQUARE FLANGE EXTENDED DIELECTRIC MALE PANEL RECEPTACLES

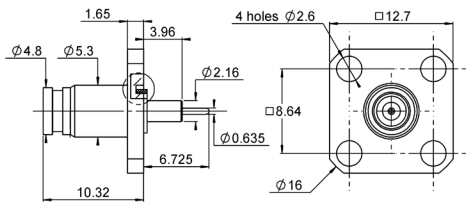

Fig. 1

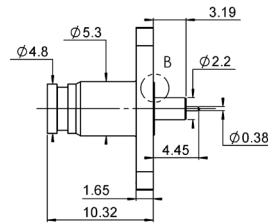
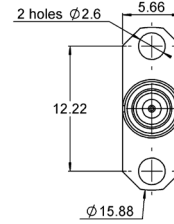
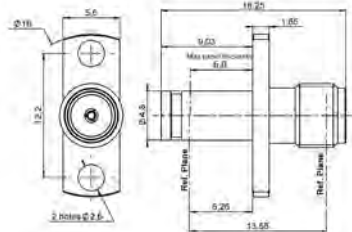

Fig. 2



Part number	Fig.	Panel drilling	Body & finish	Captive center contact	Panel mount	Contact type
R222 L10 010	1	P04	Brass gold plated	yes	4-hole flange	Cylindrical
R222 L10 020	2	P05			2-hole flange	

ADAPTERS



Part number	Panel drilling	Body & finish	Captive center contact
R191 593 400	P03	Brass gold plated	yes

Panel drilling

P01

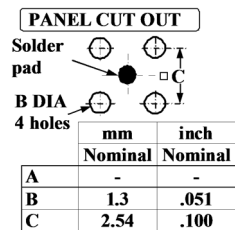

P02

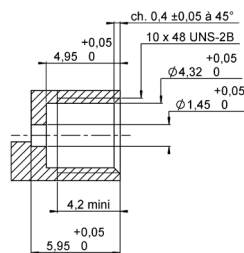

P03

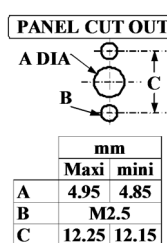

P04

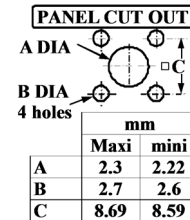

P05

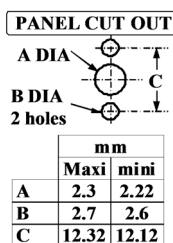

P06

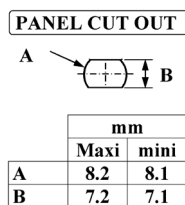

P07

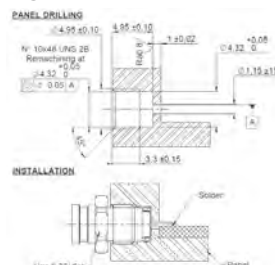

Characteristics

Test / Characteristics	Values / Remarks
------------------------	------------------

ELECTRICAL CHARACTERISTICS

Impedance	50Ω	
Frequency range	DC - 6 GHz (optimized) DC - 12.4 GHz (working range)	
Typical V.S.W.R. • Straight styles • Right angle styles • Receptacles	DC - 2.5 GHz 1.10 1.15 1.06	2.5 - 6 GHz 1.15 1.25 1.10
Insertion loss (dB)	0.12 √F (F in GHz)	
Insulation resistance (MΩ)	5000	
Voltage rating (V.R.M.S.)	750	
RF leakage	-55 dB 0 to 3 GHz -40 dB from 3 to 6 GHz	

MECHANICAL CHARACTERISTICS

	Smooth bore	Limited detent	Full detent
Mechanical endurance (matings)	100		
Engagement and separation force (N)	9 max. - 2.2 min.	45 max. - 9 min.	68 max. - 22 min.
Radial misalignment Axial misalignment	± 0.25 mm 0, +0.25 mm		
Moisture resistance	MIL-STD-202 method 106		
Cable retention (N) • .085" semi-rigid • 2/50/S • 2.6/50/S	200 35 58		
Contact captivation axial (N)	6.8		

ENVIRONMENTAL CHARACTERISTICS

Operating temperature • Standard • Semi-rigid	-55°C / +125°C -55°C / +105°C
---	----------------------------------

MATERIALS

Cable connectors	Beryllium copper or brass
Receptacles	Brass
In series adapters	Beryllium copper
Center contacts	Beryllium copper/brass
Insulators	PTFE/PEEK

PLATING

Cable connectors	NPGR
Receptacles	NPGR
In series adapters	NPGR
Center contacts	NPGR



The SMP small size dramatically increases the packaging density of 40 GHz connections (see picture: SMA2.9/SMP).

Standard packaging = 100 pieces
All dimensions are given in mm.

Plugs

STRAIGHT PLUG, FULL CRIMP TYPE FOR FLEXIBLE CABLE (female center contact)

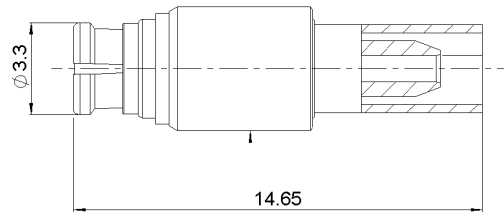

Cable group	Cable group dia.	Part number	Captive center contact
RG178/RG196	2/50/S	R222 900 100	yes
RG174/RG316	2.6/50/S	R222 900 130	

STRAIGHT PLUG, SOLDER TYPE (female center contact)

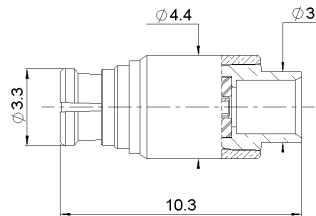

Cable group	Cable group dia.	Part number	Captive center contact
RG405	.085"	R222 900 200	no

RIGHT ANGLE PLUGS, CRIMP TYPE FOR FLEXIBLE CABLE (female center contact)

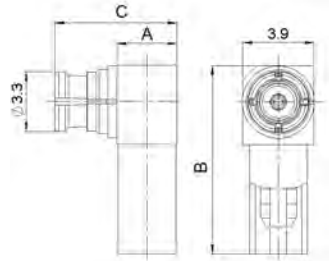
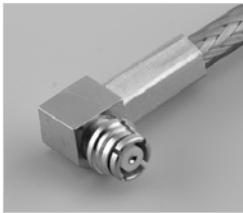

Cable group	Cable group dia.	Part number	Dimensions (mm)			Captive center contact
			A	B	C	
RG178/RG196	2/50/S	R222 900 310	3.3	10.3	6.7	yes
RG174/RG316	2.6/50/S	R222 900 320	3.7	11.3	7	
RD316	2.6/50/D	R222 900 330		13.3	7.4	

RIGHT ANGLE PLUG, SOLDER TYPE (female center contact)

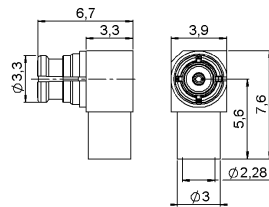

Cable group	Cable group dia.	Part number	Captive center contact
RG405	.085"	R222 900 340	yes

Receptacles and adapter

STRAIGHT SMT RECEPTACLE (male center contact)

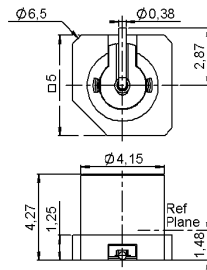

Part number	Retention	Captive center contact	Assembly instructions	Packaging
R222 941 100	Full detent	yes	M01	Tape & Reel 500 pieces
R222 941 300	Limited detent			
R222 941 700	Smooth bore			

STRAIGHT RECEPTACLES, PIN & PASTE MOUNT (male center contact)

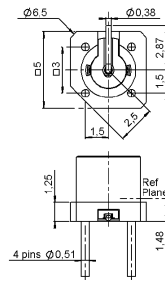
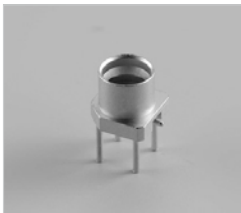

Part number	Retention	Captive center contact	Assembly instructions	Packaging
R222 940 100	Full detent	yes	M01	Tape & Reel 500 pieces
R222 940 300	Limited detent			
R222 940 700	Smooth bore			

IN SERIES ADAPTER (female to female center contact)



Please refer to page 2-20

Measurement PCB

MEASUREMENT PCB WITH SMT RECEPTACLE

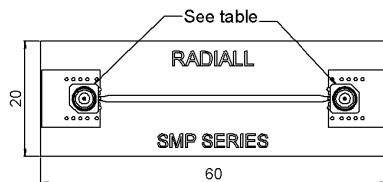

Part number	Packaging	Connector
R222 995 320	Unit	2 x R222 941 300

Packaging

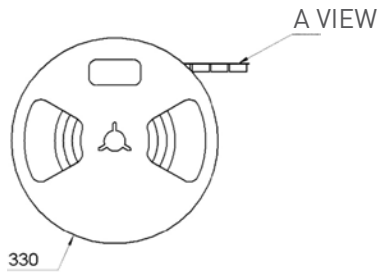

Part number	Packaging
R222 940 100	Tape & Reel 500 pieces
R222 940 300	
R222 940 700	
R222 941 100	
R222 941 300	
R222 941 700	

Connectors
R222 941 100
R222 941 300
R222 941 700

Connectors
R222 940 100
R222 940 300
R222 940 700

AIR SUNCTION

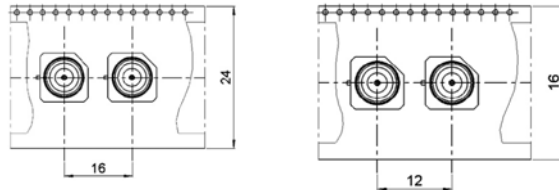
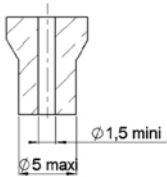

A VIEW

Assembly instructions

M01

SOLDERING PATTERN

VIDEO SHADOW

Connectors
R222 941 100
R222 941 300
R222 941 700

Connectors
R222 940 100
R222 940 300
R222 940 700

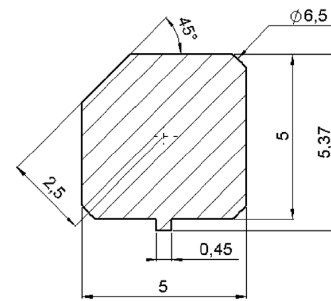
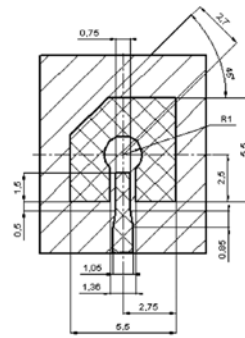
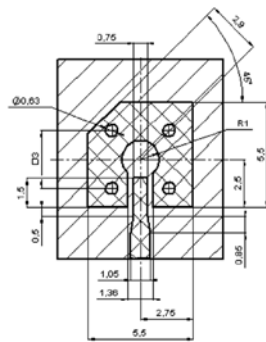



Board-to-Board: MMBX / SMP-MAX
R223 / R222M



Contents

MMBX

Introduction 3-4

Interface 3-5

Characteristics 3-6

Plugs 3-7

PCB receptacles 3-7 to 3-8

Adapters 3-9

Demo board 3-10

Panel drilling 3-10

Assembly instructions 3-10

SMP-MAX

Introduction 3-11 to 3-12

Characteristics 3-13

Jacks and plugs 3-14

Receptacles 3-15 to 3-16

Adapters and Panel drilling 3-16 to 3-17

SECTION 3 TABLE OF CONTENTS

Introduction



50Ω

DC - 12.4 GHz

GENERAL

- Snap-on mating
- Microminiature coaxial connectors
- Robust
- Surface mount receptacles
- Fully compatible with automated pick and place machines

APPLICATIONS

- Board to board applications
- Base station
- High density packaging

MMBX™ connector series is particularly suitable for board to board connection in telecommunication systems. MMBX™ connectors allow a quick connection in a minimum space requirement. Frequency range is DC to 12.4 GHz. SMT connectors are totally compatible with pick and place machines.

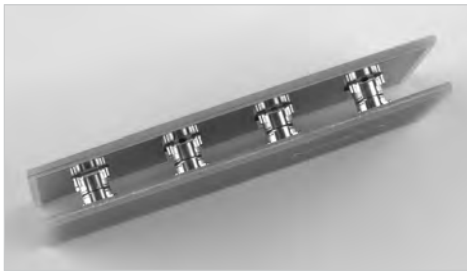

• **Space saving**

Its small size is a main advantage for applications requiring board to board distance less than 7mm.

• **Recommended use**

Receptacles and in-series adapters can be either sold separately or with the adapter already inserted in the receptacle. In this case, assembly time will be reduced and you will be sure that the in-series adapter is properly inserted.



- Retention between receptacle and in-series adapter is ensured by the asymmetrical design of the adapter:
- Snap side: for board to board application, it allows all in-series adapters to remain on the same board during disassembly.
 - Slide side: it allows quick and easy connections with large axial and radial misalignment tolerance.

Interface

PCB connectors

JACK

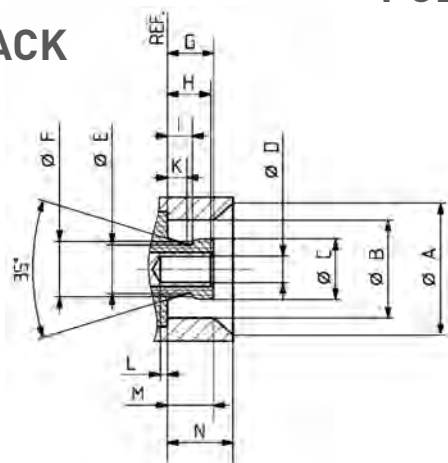

PLUG

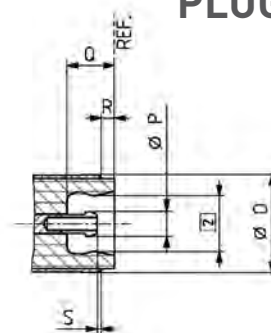

Letter	mm		inch	
	min.	max.	min.	max.
A	5.00 nom.	5.00 nom.	.197 nom.	.197 nom.
B	3.68	3.71	.145	.146
C	2.25	2.30	.088	.090
D	0.98	1.01	.038	.040
E	1.85 nom.	1.85 nom.	.073 nom.	.073 nom.
F	2.10 nom.	2.10 nom.	.083 nom.	.083 nom.
G		1.80		.071
H	1.55	1.75	.061	.069
I	0.90		.035	

Letter	mm		inch	
	min.	max.	min.	max.
K	0.75 nom.	0.75 nom.	.029 nom.	.029 nom.
L	0		0	
M	1.45		.057	
N	2.50 nom.	2.50 nom.	.098 nom.	.098 nom.
O	3.70 nom.	3.70 nom.	.146 nom.	.146 nom.
P	0.95 nom.	0.95 nom.	.037 nom.	.037 nom.
Q	1.85 nom.	1.85 nom.	.073 nom.	.073 nom.
R	0.50 nom.	0.50 nom.	.020 nom.	.020 nom.
S	0.10 nom.	0.10 nom.	.004 nom.	.004 nom.

In series adapters

Slide-on

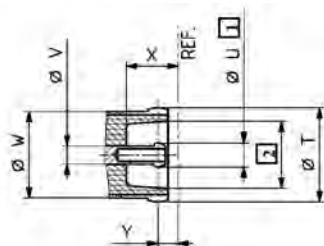

Snap-on

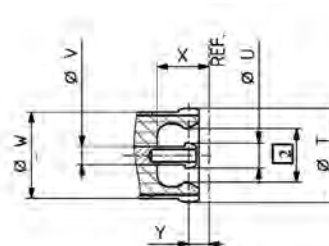

Letter	mm	inch
T	3.70 nom.	.146 nom.
U	0.95 nom.	.037 nom.
V	0.70 nom.	.027 nom.

Letter	mm	inch
W	3.65 nom.	.144 nom.
X	2.05 nom.	.080 nom.
Z	0.80 nom.	.031 nom.

- 1 Slotted and flared to meet electrical and mechanical requirements
- 2 Dimension to meet electrical and mechanical requirements

Characteristics

Test / Characteristics	CECC 22000	Values / Remarks
------------------------	------------	------------------

ELECTRICAL CHARACTERISTICS

Impedance		50Ω		
Frequency range		DC - 12.4 GHz		
Typical V.S.W.R. • Straight connectors: - 2/50/S - 2.6/50/S - 2.6/50/D • Right angle connectors: - 2/50/S - 2.6/50/S - 2.6/50/D		DC - 1 GHz	1 - 2.5 GHz	2.5 - 6 GHz
		1.05	1.06	1.10
		1.05	1.06	1.10
		1.05	1.06	1.10
		1.05	1.13	1.22
		1.05	1.06	1.13
Insulation resistance		> 1 GΩ		
Dielectric withstanding voltage (sea level)	4.4.5	500 Vrms. 50 Hz		
		750 Vrms. 50 Hz		
Contact resistance	4.4.2	≤ 5 mΩ		
		4.4.3	≤ 1 mΩ	

MECHANICAL CHARACTERISTICS

Mechanical endurance	4.7.1	100 matings
Engagement and separation force	4.5.4	30 N max
		8-30 N
Contact captivation	4.5.2	≥ 10 N
Cable retention force		58 N
		110 N
Vibration	4.6.3 - IEC 68-2-6 Fc	MIL-STD-202, Method 204 D, condition A

ENVIRONMENTAL CHARACTERISTICS

Temperature range		-55°C + 155°C
Thermal shock	4.6.7 - IEC 68-2-14 Na	MIL STD 202, method 107G, condition B1
Moisture resistance	4.6.6 - IEC 68-2-3 Ca	MIL STD 202, method 106F
Corrosion	4.6.10 - IEC 68-2-11 Ka	MIL STD 202, method 101, condition B
Vibration	4.6.3 - IEC 68-2-6 Fc	MIL STD 202, method 204D, condition A

MATERIALS

Center & outer contacts		Beryllium copper
Bodies		Brass
Ferrules		Copper
Insulators		PTFE

PLATING

Center & outer contacts		Gold/NPGR
Bodies		NPGR
Ferrules		NPGR

All dimensions are given in mm.
Standard packaging = 100 pieces.

Plugs and PCB receptacles

STRAIGHT PLUGS (male center contact)

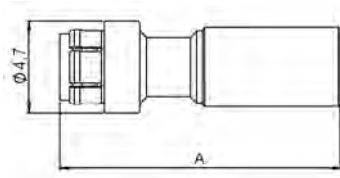

Fig. 1

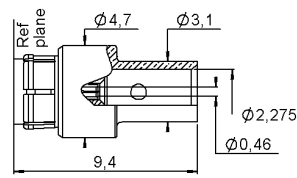

Fig. 2

Cable group	Cable group dia.	Part number	Fig.	A	Captive center contact	Note
RG178 / RG196	2/50/S	R223 081 000	1	14.3	yes	Crimp type for flexible cables
RG174 / RG316	2.6/50/S	R223 082 000		14.5		
RG316	2.6/50/D	R223 083 000				
RG405	.085"	R223 062 000	2			Solder type for semi-rigid cables

RIGHT ANGLE PLUGS (male center contact)

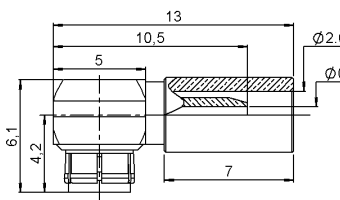

Fig. 1

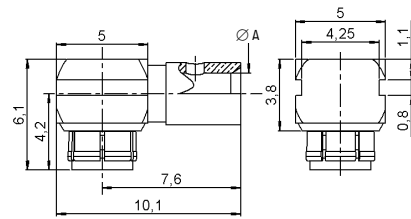

Fig. 2

Cable group	Cable group dia.	Part number	Fig.	A	Captive center contact	Note
RG178 / RG196	2/50/S	R223 181 000	1		yes	Crimp type for flexible cables
RG174 / RG316	2.6/50/S	R223 182 000				
RG316	2.6/50/D	R223 183 000				
RG405	.085"	R223 162 000	2	2.275		Solder type for semi-rigid cables

STRAIGHT PCB RECEPTACLES WITH PRE-ASSEMBLED ADAPTER (male center contact)

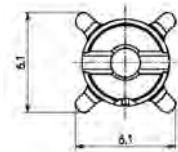

Fig. 1

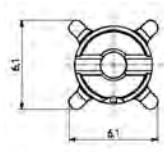

Fig. 2

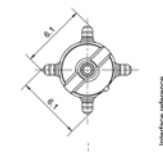
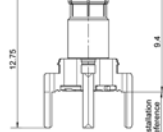
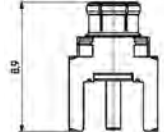
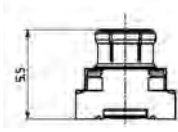

Fig. 3



Part number	Fig.	Captive center contact	PCB	Assembly instructions	Packaging	Note
R223 434 000	1	yes	P01	M01	Bulk 100 pieces	SMT
R223 434 800					Tape & Reel 750 pieces	
R223 435 000	2					
R223 435 010	3					

PCB receptacles

EDGE CARD PCB RECEPTACLES (female center contact)

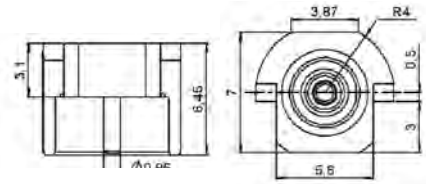

Part number	Captive center contact	Packaging	Note
R223 423 010	yes	Bulk 100 pieces	SMT
R223 423 800		Tape & Reel 650 pieces	

STRAIGHT PCB RECEPTACLES (female center contact)

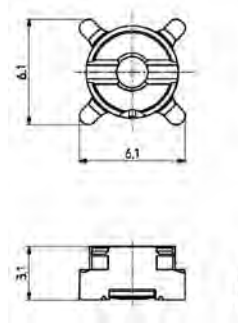
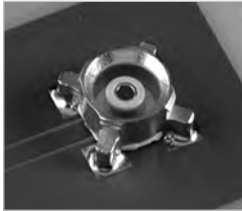

Fig. 1

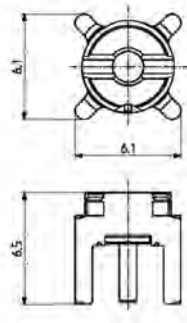

Fig. 2

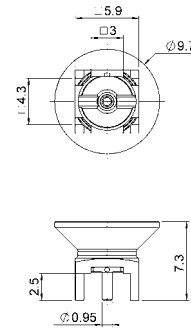

Fig. 3

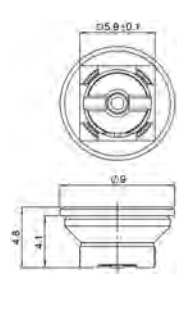
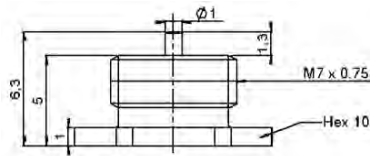

Fig. 4

Part number	Fig.	Captive center contact	PCB	Assembly instructions	Packaging	Note
R223 424 000	1	yes		M01	Bulk 100 pieces	SMT
R223 424 800					Tape & Reel 750 pieces	
R223 424 870	4			M02	Bulk 100 pieces	Catcher's mitt
R223 425 000	2			P01		Bulk 100 pieces
R223 425 800					Tape & Reel 500 pieces	
R223 425 810	3					Tape & Reel 500 pieces

SCREW-ON RECEPTACLE (female center contact)



Part number	Captive center contact	Panel drilling
R223 555 000	yes	P02

Adapters

IN SERIES ADAPTERS (male-male center contact)

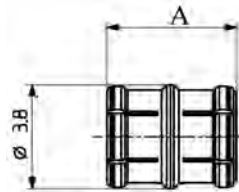

Fig. 1

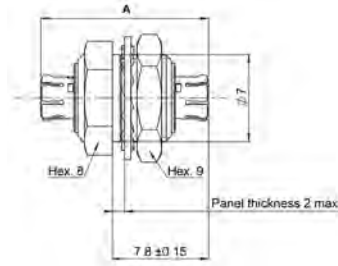

Fig. 2

Part number	Fig.	Length A (mm)	Type	Nominal board to board distance
R223 703 180	1	4.8	Snap-slide	6.7
R223 703 020		9.7	Slide-slide	11.7
R223 703 040		12	Snap-slide	14
R223 703 080		7		9
R223 703 230		20.4		22.4
R223 720 020	2	13.6	Slide-slide Bulkhead	-

Other lengths available, please contact us.

BETWEEN-SERIES ADAPTERS

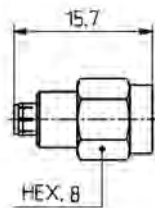

Fig. 1

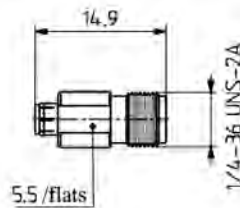

Fig. 2

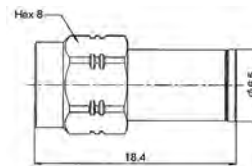

Fig. 3

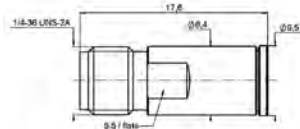

Fig. 4

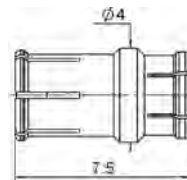

Fig. 5

Part number	Fig.	Series	Packaging
R191 389 100	1	MMBX male/SMA male	Unit
R191 389 200	2	MMBX male/SMA female	
R191 389 300	3	MMBX female/SMA male	
R191 389 400	4	MMBX female/SMA female	
R191 560 000	5	SMP-MAX female/MMBX male snap	Bulk 100 pieces

Other configurations available, with flange, straight and right angle. Please contact us.

Demo board



Part number	Note
R223 990 000	2 SMT receptacles

Panel drilling

P01

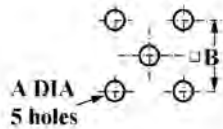

	mm		inch	
	maxi	mini	maxi	mini
A	1.4	1.2	.055	.047
B	5.16	5	.203	.197

P02



Threading	
ØA	M7 x 0.75

Assembly instructions

M01

Part number					
R223 424 000	R223 424 800	R223 434 000	R223 434 800	R223 435 000	R223 435 010

COPLANAR LINE

- Pattern and signal are on the same side.
- The material of PCB is epoxy resin (FR4) (Er = 4.6).
- The solder resist should be printed except for the land pattern on the PCB.

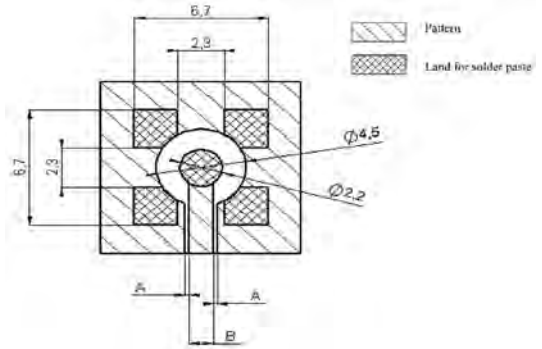

APPLICATION 75Ω WITH B = 0.55 mm

PCB thickness (mm)	Coplanar line A (mm)
0.8	0.350
1.0	0.360
1.2	0.365
1.6	0.375

APPLICATION 50Ω WITH B = 1.2 mm

PCB thickness (mm)	Coplanar line A (mm)
0.8	0.190
1.0	0.200
1.2	0.205
1.6	0.210

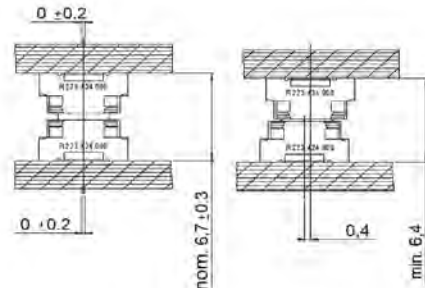
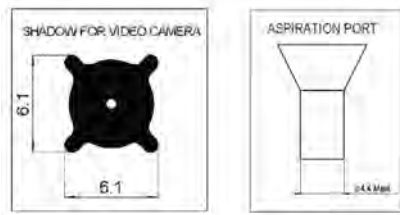

Not valid for R223 424 870, please consult data sheet.

Introduction



Board-to-Board solutions

The Best Systems

Radiall's engineers work with your engineers, allowing us to develop the best competitively priced misalignment RF coaxial interconnect solutions on the market today.

The Best Choices

Radiall offers more board to board choices with four different product groups and ten connector series, that can address the most demanding wireless telecom applications required for the new generation of infrastructure compact equipment. From base stations to repeaters and even handheld and GPS devices, we have a tailored connector solution for you, including the new SMP-MAX, SMP-Spring, IMP-Spring and other large, limited and no misalignment solutions.



SMP-MAX

Get the best for less with the new SMP-MAX large misalignment solution. Its patented impedance matching insulator is optimized for a larger operating gap between connectors making it easier for engineers to handle a board-to-board distance tolerance of at least .078" (2.0 mm) without a spring, which is 300% more than the standard SMP. It features a 3° minimum tilt (radial travel) and it has an operating frequency range of DC-6 GHz and a 1.2 max VSWR guaranteed at DC-3 GHz.



SMP-MAX Receptacle



SMP-MAX Adapter

Spring-loaded Connectors

Radiall's one connector IMP-Spring and three connector SMP-Spring, MMBX-Spring, and BMR-Spring large misalignment spring-loaded series are the best for increased maximum distance tolerances. IMP-Spring is a cost effective, unique one connector solution that offers up to .023" (.6 mm) board to board distance tolerance with a tilt (radial travel) up to 4.5°. The new SMP-Spring and MMBX-Spring offer up to .078" (2 mm) board-to-board distance tolerance and a 4.5° tilt (radial travel). All spring-loaded solutions feature consistent VSWR and low RF leakage.



IMP-Spring and SMP-Spring

Limited Misalignment

Radiall's one connector IMP and three connector SMP and MMBX limited misalignment series are designed for applications requiring relatively precise distance tolerance of up to .023" (.6 mm) with a tilt (radial travel) of up to 4.5°.



IMP

No Misalignment

Radiall's MMT, MMS and MCX series are designed for applications requiring little or no distance tolerance between boards.

Introduction



50Ω	DC - 6 GHz
-----	------------

GENERAL

- Microminiature coaxial connectors
- Power up to 300 Watts
- Board to board distance misalignment of at least 0.078" (2.0 mm)
- Tilt (radial misalignment): 3° minimum
- 1.2 max VSWR at DC - 3 GHz

APPLICATIONS

- Broadcast
- RF components (filters, amplifiers,)
- Wireless communications

The cost-effective solution for maximum mechanical misalignment

Of the several RF connectors available for interconnections in wireless remote radio heads, repeaters, base stations, GPS devices, and similar applications, the board-to-board style connector is growing in popularity. The product line has evolved from accommodating limited misalignment to offering the widest tolerances available.

SMP-MAX was introduced by Radiall to provide larger misalignment tolerances than the early version board-to-board connectors like SMP or SMP-spring while offering lower cost.

Featuring an optimized interface, SMP-MAX can work up to 6 GHz board-to-board distance misalignment at least 2.0 mm and radial misalignment 3° minimum.

The SMP-MAX series offers 2 levels of retention provided by the receptacles:

- Slide-on, for the lowest retention
- Snap-on, for a positive locking with a retention

A complete SMP-MAX board-to-board system is made of 3 parts:

SMP-MAX Slide-on receptacle	SMP-MAX In series adapter	SMP-MAX Snap-on receptacle
		

Many other custom configurations are available. Larger distance misalignment and larger tilt versions are also available.

Characteristics

Test / Characteristics	Values / Remarks		
ELECTRICAL CHARACTERISTICS			
Impedance	50Ω		
Frequency	DC - 6 GHz		
Typical V.S.W.R. (Board to Board connection)	Misalignment	DC - 3 GHz	3-6 GHz
	Radial 0°, Axial 0 mm	< 1.15	< 1.25
	Radial 0°, Axial +/- 1 mm	< 1.20	< 1.35
	Radial 3°, Axial 0 mm	< 1.15	< 1.25
	Radial 3°, Axial +/- 1 mm	< 1.20	< 1.35
Insertion loss (Board to Board connection)	Misalignment	DC - 3 GHz	3-6 GHz
	Radial 0°, Axial 0 mm	0.10	0.15
	Radial 0°, Axial +/- 1 mm	0.12	0.25
	Radial 3°, Axial 0 mm	0.10	0.15
	Radial 3°, Axial +/- 1 mm	0.12	0.25
Insulation resistance	5000 MΩ		
Center contact resistance	< 3 mΩ		
Outer contact resistance	< 1.5 mΩ		
Working voltage	330 VRMS		
Dielectric withstanding voltage	1000 VRMS		
Power handling (typical)	> 300W @ 2.7 GHz, 25°C > 200W @ 2.7 GHz, 85°C		
RF leakage	-70dB to 3 GHz, axial misalignment 0mm		

MECHANICAL CHARACTERISTICS

Mating cycles	100 cycles	
	Slide-on	Snap-on
Engagement force	< 14 N	< 45 N
Disengagement force	< 9 N	> 9, < 45 N
Center contact retention force	> 7 N	
Minimum distance between PCB	13 mm	
Radial misalignment tolerance	3°min	
Axial misalignment tolerance	2.0 mm Larger axial misalignment version available	

ENVIRONMENTAL CHARACTERISTICS

Temperature range	-55°C / +165°C
Thermal shock	MIL-STD-202, method 107, condition B
Vibration	MIL-STD-202, method 204, condition B
Shock	MIL-STD-202, method 213, condition A
Corrosion salt spray	MIL-STD-202, method 101, condition B
Moisture resistance	MIL-STD-202, method 106

MATERIALS

Body	Brass / Beryllium copper
Male center contact	Brass
Female center contact	Beryllium copper
Gasket	Silicon rubber
Insulator	PTFE / PEEK

PLATING

Body	NPGR / BBR
Male center contact	NPGR
Female center contact	NPGR

Packaging = 100 pieces box / 500 pieces reel.
All dimensions are given in mm.

Jacks, plugs and cabling

BULKHEAD STRAIGHT SLIDE-ON MALE JACKS FOR CABLES

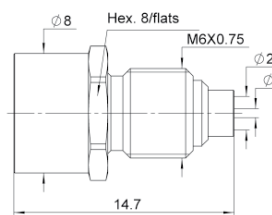

Fig. 1

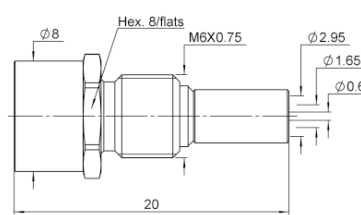
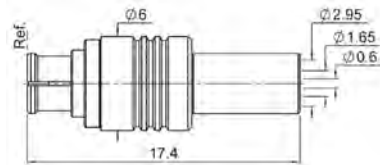

Fig. 2

Cable group	Cable group dia.	Part number	Fig.	Captive center contact	Panel drilling	Packaging
RG405	.085"	R222 M20 700	1	yes	P01	Bulk 100 pieces
RG174 / RG316	2.6/50/S	R222 M20 710	2			

STRAIGHT FEMALE PLUG FOR FLEXIBLE CABLE



Cable group	Cable group dia.	Part number	Captive center contact	Packaging
RG174 / RG316	2.6/50/S	R222 M80 400	yes	Bulk 100 pieces

RIGHT ANGLE FEMALE PLUG FOR FLEXIBLE CABLE

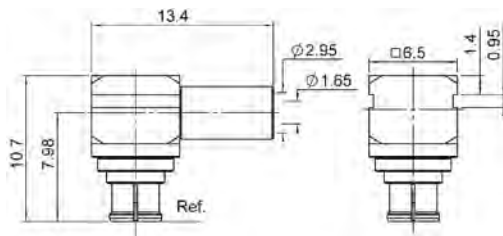

Fig. 1

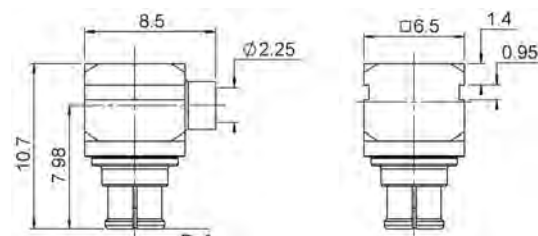
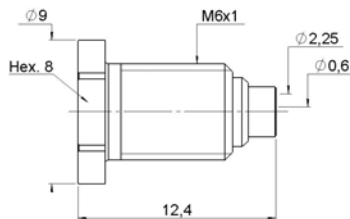

Fig. 2

Cable group	Fig.	Cable group dia.	Part number	Captive center contact	Packaging
RG174 / RG316	1	2.6/50/S	R222 M80 500	yes	Bulk 100 pieces
RG405	2	.085"	R222 M80 517		

BULKHEAD MALE JACK SNAP TYPE



Cable group	Cable group dia.	Part number	Captive center contact	Panel drilling	Packaging
RG405	.085"	R222 M20 017	no	P05	100

Receptacles

STRAIGHT SLIDE-ON MALE RECEPTACLES

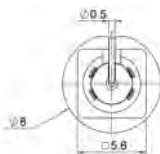

Fig. 1

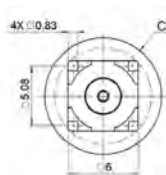

Fig. 2

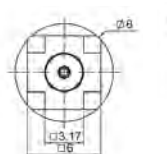

Fig. 3

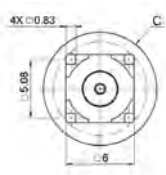

Fig. 4

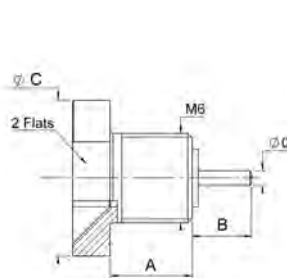
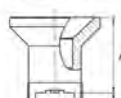
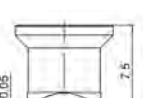
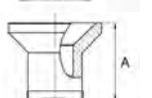
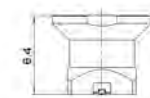

Fig. 5

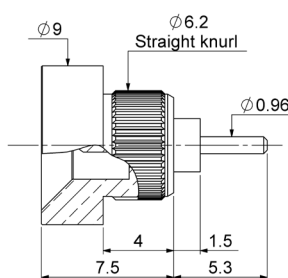

Fig. 6

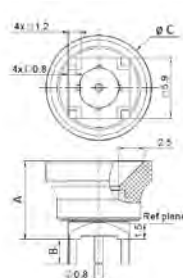

Fig. 7

Part number	Fig.	Dimensions (mm)			Captive center contact	Panel drilling	Packaging	Note
		A	B	C				
R222 M00 700	1				yes	Tape & Reel 500 pieces	SMT	
R222 M00 720	2	7.5	1.9	8.3		P02	Bulk 100 pieces	Solder legs
R222 M00 770		8.4	3.4	10				Center contact dia. 0.95
R222 M00 730	4	7.7	1.9	8.3		P03	Tape & Reel 400 pieces	PIH + SMT, with cap
R222 M00 740	3						Tape & Reel 500 pieces	SMT
R222 M10 700	5	5.6	2	9		P01	Bulk 100 pieces	Screw-on
R222 M10 730	6					P04		Press in
R222 M10 750	5	5.6	4	10.5		P01		
R222 M00 790	4	13.3	1.9	12		P03		PIH + SMT
R222 M00 860	2	7.3	3.5	10		P02	Bulk 100 pieces	Solder legs
R222 M00 880		7.7	2.4					PIH + SMT
R222 M00 890	4	7.2	1.7				500	Composite catcher's mitt / SMT
R222 M03 700	7	7.6	0	10.2		P02	Bulk 100 pieces	Composite catcher's mitt / Solder legs
R222 M03 880		7.7	2.4	10				

Receptacles and adapters

STRAIGHT SNAP-ON MALE RECEPTACLES

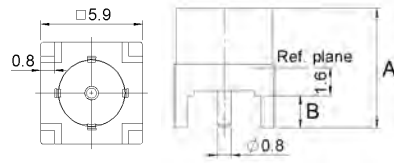

Fig. 1

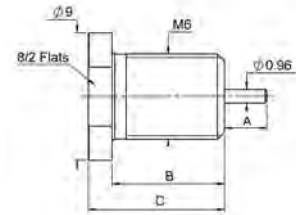

Fig. 2

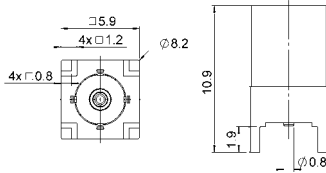

Fig. 3

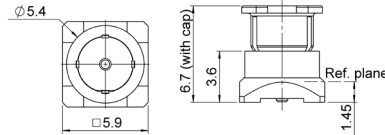

Fig. 4

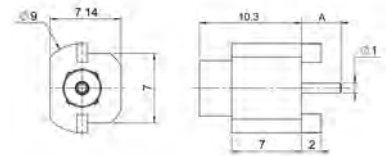

Fig. 5

Part number	Fig.	Dimensions (mm)			Captive center contact	Panel drilling	Packaging	Note
		A	B	C				
R222 M10 000	2	2	7.1	11.15	yes	P01	Bulk 100 pieces	Screw-on, with cap
R222 M10 030		3.5	9.1	11.2				
R222 M10 060		4.1	6.5	8.5				
R222 M00 080	1	7	1.9	P02		Tape & Reel 500 pieces	Solder legs	
R222 M00 090	3							
R222 M00 160	1	8.6	3.5			P03	Bulk 100 pieces	Solder legs
R222 M01 000		6.7	1.7					
R222 M01 040	3					P02	Bulk 400 pieces	PIN + SMT
R222 M01 090	5	4						
R222 M01 140		3					P03	Tape & Reel 500 pieces
R222 M03 000	4				P05	Bulk 100 pieces		
								Tape & Reel 500 pieces

IN-SERIES BOARD-TO-BOARD ADAPTERS

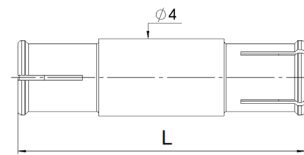

Fig. 1

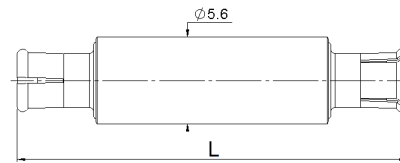
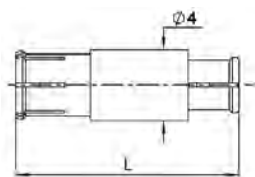

Fig. 2

Part number	Length L (mm)	Fig.	Series	Packaging
R222 M40 010	9.5	1	SMP-MAX female / SMP-MAX female	Bulk 100 pieces
R222 M40 050	25.3			
R222 M40 060	12.15			
R222 M40 070	14.9			
R222 M40 080	13.8			
R222 M43 052	25.3			
R222 M43 072	14.9			
R222 M43 112	16.7			
R222 M43 192	50.5			
R222 M43 202	45.2			
R222 M43 212	46.25	2		
R222 M43 222	51.15			
R222 M43 262	67.5			
R222 M46 012	9.5			
R222 M46 032	7.2	1		

Receptacles

BETWEEN-SERIES BOARD-TO-BOARD ADAPTERS



Part number	Lenght L (mm)	Series	Packaging
R191 996 110	12.6	SMP-MAX female / SMP female	Bulk 100 pieces
R191 996 130	8.9		
R191 560 000	7.5	SMP-MAX female / MMBX male snap	

BETWEEN-SERIES ADAPTERS

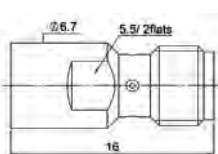

Fig. 1

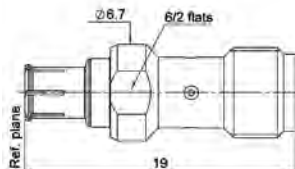
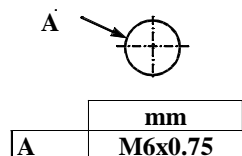

Fig. 2

Part number	Fig.	Series	Packaging
R191 552 000	1	SMP-MAX male / SMA female	Unit
R191 553 000	2	SMP-MAX female / SMA female	

Panel drilling

P01



P02

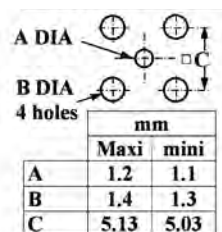

P03

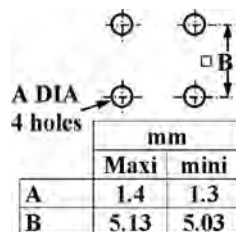

P04

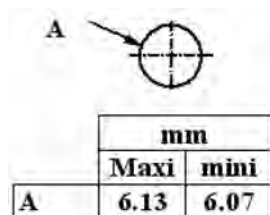

P05

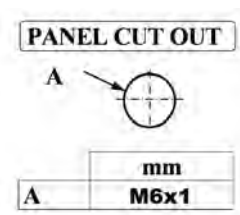

SECTION 4



Coaxipack 2
R694



Contents

COAXIPACK 2

Introduction 4-4 to 4-5

Characteristics 4-6

PCB modules 4-7 to 4-9

Feedthrough male cable assembly 4-10

Feedthrough male male adapter kits 4-11

Cable assembly 4-12 - 4-13

Samples and guide pins 4-14

Extraction procedures 4-15

SECTION 4 TABLE OF CONTENTS

Introduction

The Coaxipack 2 series has been designed in accordance with the IEC 61076-4-104 (standard 2mm geometry system). Coaxipack 2 provides high density coaxial connectors aimed at high speed and space saving applications. The Coaxipack 2 series is available in 50Ω and 75Ω.

APPLICATIONS

50Ω RANGE

- Telecom / Datacom (Transmission equipment, Satellite Communication Systems, Base station)
- Medical
- Networking industry
- Instrumentation

75Ω RANGE

- High speed data network
- Digital Broadcast System (Routers, Switching and Control Systems, Monitoring and Signal Measurement, Encoders etc...)

FEATURES AND BENEFITS

Coaxipack 2 combines high performance miniature coaxial connectors with the convenience, compacity and cost effectiveness of 2mm metric systems.

FEATURES

- Excellent for coaxial signal transmission: low crosstalk, low signal distortion, high level of EMI/RFI shielding
- High speed performance: Minimum reflection and propagation delay, sub-nanosecond rise time capabilities
- Ruggedized for a variety environments: Industrial applications, humidity, shock, vibration...

BENEFITS

- Space savings on PCB, reduced PCB routing complexity and supplies adequate spacing for high speed routing.
- Stackable with other 2mm metric modules (ex: power, signal) from most manufacturers.
- Maximum flexibility in system architecture due to Coaxipack's modular design-system designers are able to upgrade designs and add new functions without having to adopt major changes in the hardware configuration.

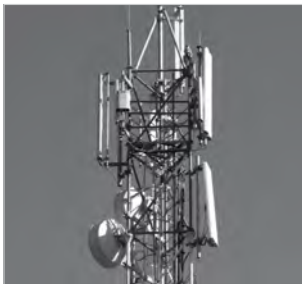
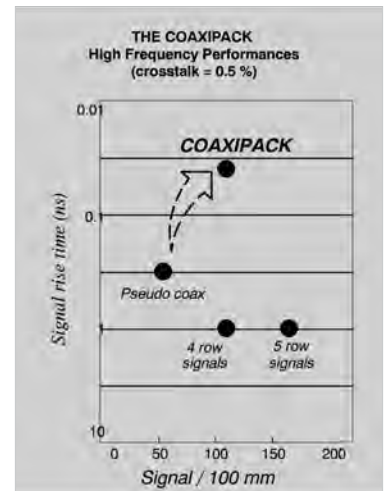

Introduction

MODULE

- Radiall offers a large range of pre-assembled modules. The term "module" is used for Coaxipack 2 connector mounting on board configuration.
- One module combines a housing including one or more inserts. The number of inserts depends on the required configuration, up to 6 contacts.



- Depending on the part number, one insert is made of one or two coaxial contacts.



CABLE ASSEMBLIES

Radiall offers a standard kit including straight female insert and housing which fully complies with the IEC 61076-4-104.

TECHNOLOGY BREAKTHROUGH INNOVATION

- **Interface:** Robust guidance and mating tolerances with reinforced interface provides a perfect alignment without any risk of loss of contact.
 - Male: New chamfers on outer contact and new radius on center contact for improved guidance
 - Female: New chamfered and extended insulator prevents any misalignment in very high density applications
- **Packaging:** Improved design of packaging to secure the connectors and prevent any damage during the transportation or handling. All connectors are shipped in a tray for safety during transportation and an added convenience during the manufacturing process.

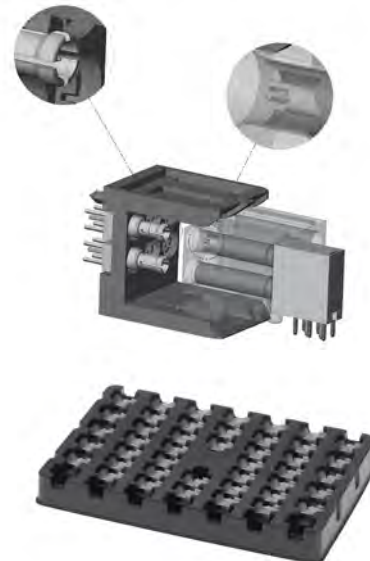

ORDERING GUIDE

- **Connector choice**
Radiall offers either ready to use modules (housing + inserts) or ca
- **Shielded connectors**
Additional choices with two ways of plating to improve the shielding level:
 - (1) Addition of metal plates to the plastic housing
 - (2) Metallization of the plastic housing

Characteristics

ELECTRICAL CHARACTERISTICS

Frequency range	DC-3 GHz (Optimized) - (Working range up to 6 GHz)	
Impedance	50Ω and 75Ω	
V.S.W.R mated pair for <ul style="list-style-type: none"> • PCB modules • Straight female - cable assembly • Straight male - cable assembly 	DC-1 GHz < 1.08 < 1.15 < 1.13	1-3 GHz < 1.12 < 1.30 < 1.20
Insertion loss mated pair	0.2 dB typical from 0 to 3 GHz	
RF leakage	-35 dB at 3 GHz	
Voltage rating	500 V	
Dielectric withstanding voltage	750 V	
Insulation resistance	≥ 5000 MΩ	
Contact resistance <ul style="list-style-type: none"> • Center contact • Outer contact 	Initial	After environment test
	< 5 mΩ	< 15 mΩ
	< 2.5 mΩ	< 7.5 mΩ
Rise time degradation (corrected for board effects) at 300ps	6 ps	
Difference in propagation delay between shortest and longest line	26 ps	
Near end crosstalk at 300ps	0.2 %	

MECHANICAL CHARACTERISTICS

Mating cycles	500
Insertion force	2.5 N
Extraction force	2.2 N
Contact density	2 to 6 contacts per module 60 contacts per 120 mm x 16 mm

ENVIRONMENTAL CHARACTERISTICS

Temperature range	-25 / +125°C
-------------------	--------------

MATERIALS

Housing	Liquid Crystal Polymer (LCP) glass filled
Bodies & contacts	Brass or bronze (see technical data sheet for details)
Insulators	PTFE / PEEK
Spring contacts	Beryllium copper

PLATING

Coaxial contacts	NPGR
------------------	------

PCB modules

RIGHT ANGLE FEMALE PCB MODULES (50Ω)

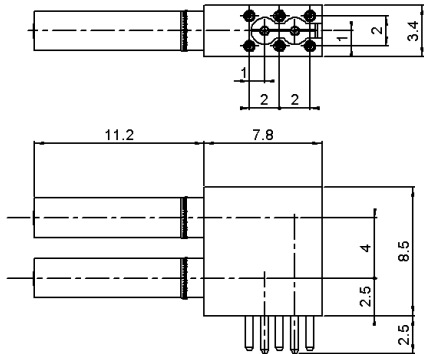
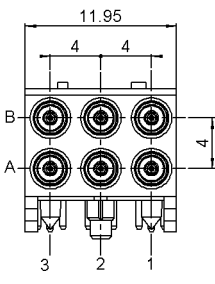
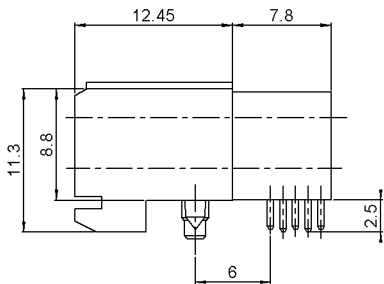
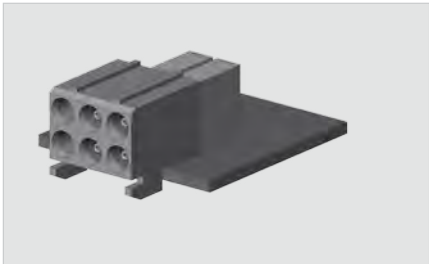
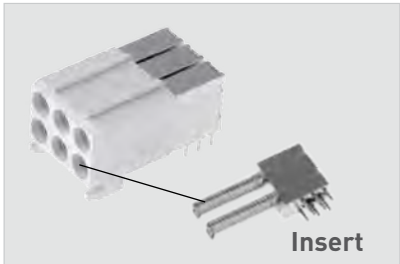

Recommended PCB thickness: 1.6 mm

Insert
(not sold separately)

Number of contacts	Position	Part number	Packaging (pieces/tray)
2		R694 252 101	50
		R694 252 102	
		R694 252 103	
4		R694 252 104	
		R694 252 105	
		R694 252 106	
6		R694 252 107	

COAXIPACK 2

PCB modules

STRAIGHT MALE PCB MODULES (50Ω)

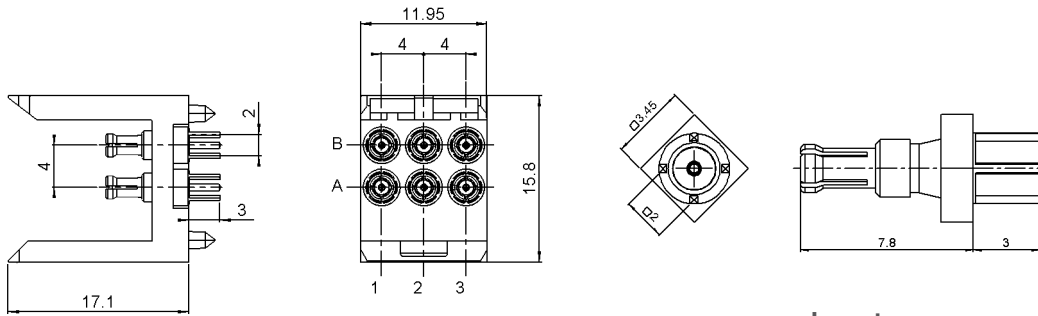
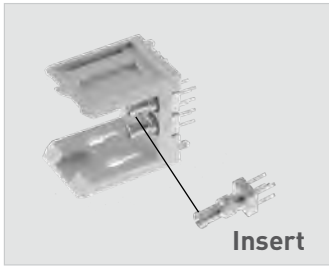

Recommended PCB thickness: 2 mm max

Insert
(not sold separately)

Number of contacts	Position	Part number	Packaging (pieces/tray)
2		R694 251 021	50
		R694 251 022	
		R694 251 023	
4		R694 251 024	
		R694 251 025	
		R694 251 026	
6		R694 251 027	

PCB modules

RIGHT ANGLE MALE PCB MODULES (50Ω and 75Ω)

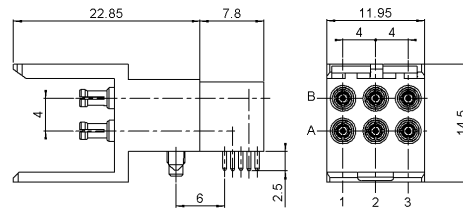
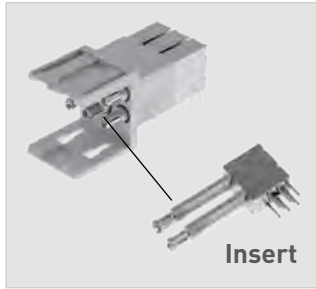

Recommended PCB thickness for 50Ω: 1.6 mm
for 75Ω: 2.4 mm

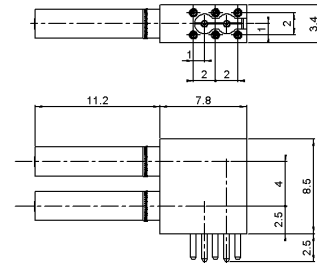

Insert
(not sold separately)

50Ω					
Number of contacts	Position of insert	Part number ⁽¹⁾	Dimension a (mm)	Extraction procedure	Packaging (pieces/tray)
2		R694 251 111	2.5	U01	25
		R694 251 112			
		R694 251 113			
4		R694 251 114			
		R694 251 115			
		R694 251 116			
6		R694 251 117			

75Ω					
Number of contacts	Position of insert	Part number ⁽²⁾	Dimension a (mm)	Extraction procedure	Packaging (pieces/tray)
2		R694 281 251	3.3	U01	25
		R694 281 252			
		R694 281 253			
4		R694 281 254			
		R694 281 255			
		R694 281 256			
6		R694 281 257			

Note

⁽¹⁾ Housing is available in shielded version. For specific request, please consult sales

⁽²⁾ With shielded version.

COAXIPACK 2

Our Most Important Connection is with You.™

Feedthrough male cable assembly



STRAIGHT MALE HOUSING

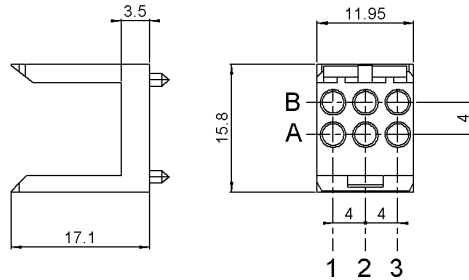
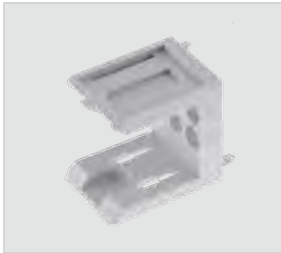

Part number	Note
R694 261 906	For removable inserts (not included)

STRAIGHT MALE REMOVABLE INSERTS, FULL CRIMP TYPE

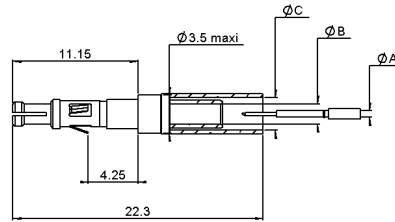

Cable group	Cable group dia.	Part number	Dimensions (mm)			Recommended PCB thickness (mm)	Extraction procedure
			A	B	C		
RG 178	2/50/S	R199 001 203	0.4	1	2.55	3.2 ± 0.1	U01
RG 174	2.6/50/S	R199 001 223	0.6	1.8	2.92	3.2 ± 0.1	

7 different possible configurations

2 Inserts			4 Inserts			6 Inserts

Feedthrough male male adapter kits



FOR REMOVABLE INSERT (50Ω)

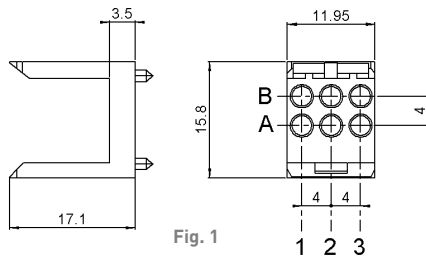
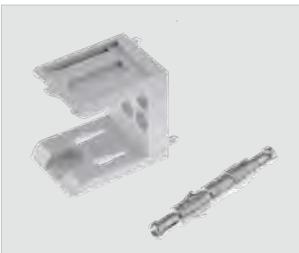

Fig. 1

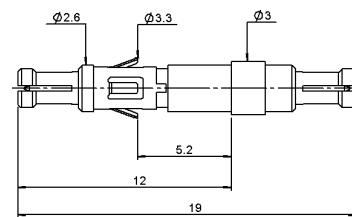

Fig. 2

Designation	Part number	Fig.	Panel thickness (mm)	Extraction procedure
Housing	R694 261 906 ⁽¹⁾	1		
Male male insert	R199 001 733	2	3.2 ± 0.05	U01

FOR NON REMOVABLE INSERT (50Ω)

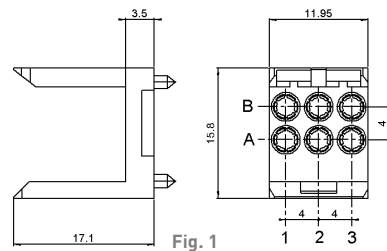

Fig. 1

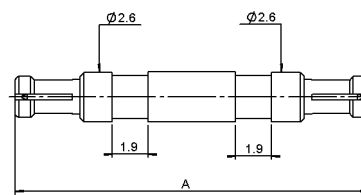

Fig. 2

Designation	Part number	Fig.	Dimension A (mm)	Panel thickness (mm)
Housing	R694 261 076 ⁽¹⁾	1		
Non removable insert ⁽²⁾	R199 001 703	2	18	2 ± 0.1
	R199 001 713		18.6	2.4 ± 0.2

Note

⁽¹⁾ Kits including housing and inserts are available. Please consult sales.

⁽²⁾ Other length and PCB thickness available upon request: please consult sales.

Cable assembly

Each cable assembly consists of:

- One housing
- One cover
- One latch
- One or several inserts corresponding to customer's configuration

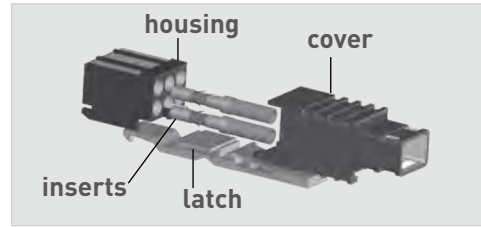

HOUSING Two types of housing for straight female cable assembly kit are offered:

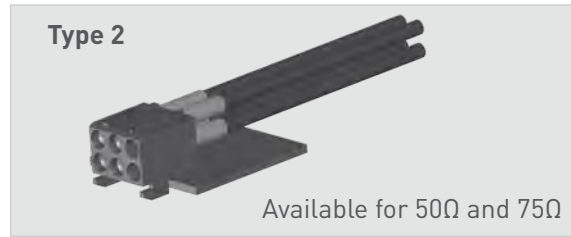
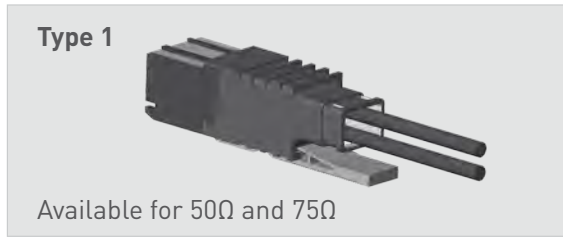

Type 1: HOUSING FOR FEMALE INSERTS

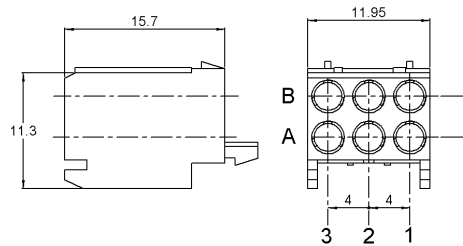

Part number
R694 262 056

Straight inserts (see page 5-14)
for 50Ω: **R199 001 003** or **R199 001 023**
for 75Ω: **R199 001 053**

Type 2: HOUSING FOR FEMALE INSERTS WITH PRESS - IN FIXING STUD (for panel and PCB mounting)

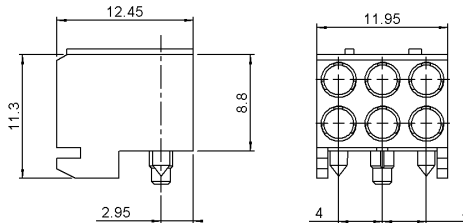

Part number
R694 262 906

Straight inserts (see page 5-14)
for 50Ω: **R199 001 003** or **R199 001 023**
for 75Ω: **R199 001 053**

COVER (type 1 only)

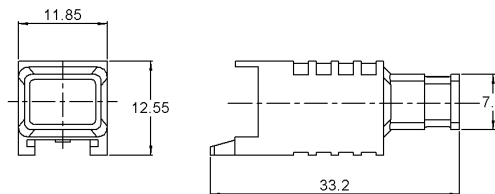

Part number
R280 420 010

Cable assembly

LATCH (type 1 only)

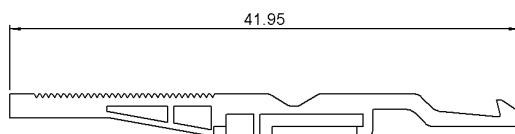

Part number
R280 420 030

KIT: COVER + FEMALE HOUSING + LATCH (type 1 only)

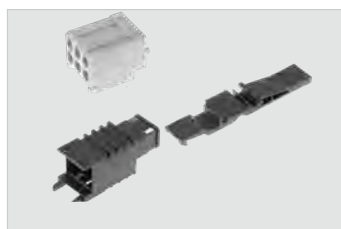

Part number	Composed of
R280 420 058	R694 262 056 + R280 420 010 + R280 420 030

STRAIGHT FEMALE REMOVABLE INSERTS, FULL CRIMP TYPE (type 1 and 2)

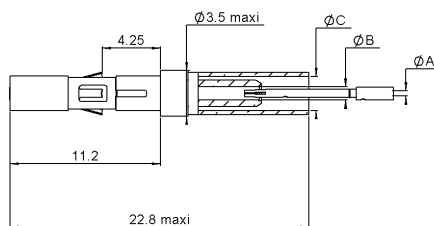

Impedance	Cable group	Cable group dia.	Part number	Dimensions (mm)			Extraction procedure	Packaging
				A	B	C		
50Ω	RG 178	2/50/S	R199 001 003	0.4	1	2.55	U02	100 pieces
	RG 174	2.6/50/S	R199 001 023	0.6	1.7	2.92		
75Ω		2.5/75/D	R199 001 053	0.4	1.2	2.95		

COMPLETE CABLE ASSEMBLY KIT (non assembled)

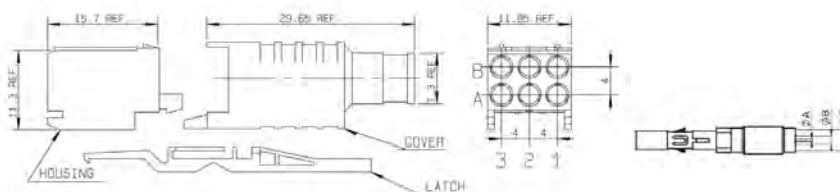
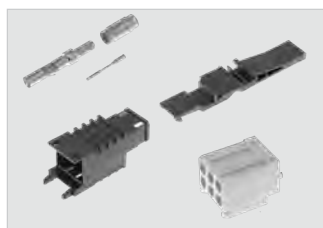

include housing + latch+ 6 contacts + cover (cable not included)

Impedance	Cable group	Cable group dia.	Part number	Position	Dimensions (mm)			Extraction procedure	Packaging
					A	B	C		
50Ω	RG 178	2/50/S	R694 252 507		0.4	1	2.55	U02	30 pieces
	RG 174	2.6/50/S	R694 252 537		0.6	1.7	2.92		
75Ω		2.5/75/D	R694 252 557		0.4	1.2	2.95		

Samples and guide pins

SAMPLE PIGTAIL



Part number	Position	Designation	Note
R284 906 002		20 cm pigtail	Can be used with demonstration board R299 400 020

STANDARD SAMPLE CABLE ASSEMBLY



Part number	Position	Designation
R284C0431006		Coaxipack cable assembly 15 cm

STANDARD SAMPLE CABLE ASSEMBLY (equipped with female coaxial inserts)

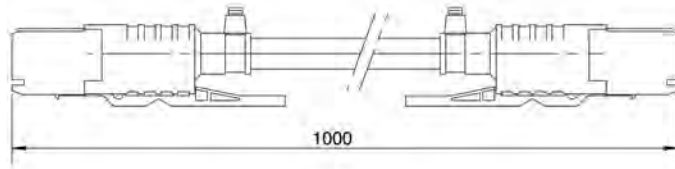

Cable group	Cable group dia.	Part number	Extraction procedure
RG 174	2.6/50/S	R285 930 005	U02

Special configuration are available upon request. Please consult sales.

GUIDE PINS

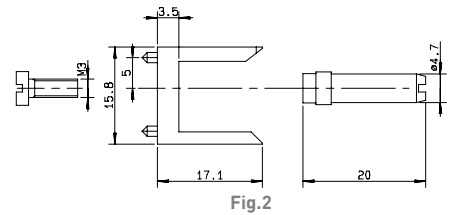
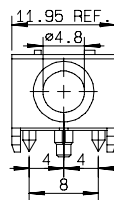
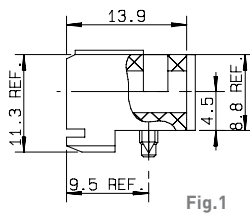

Part number	Fig.	Designation
R280 420 300	1	Female housing for guide pin
R280 420 200	2	Kit = Male housing + guide pin + screw

⁽¹⁾ Other guide pin length available upon request. Please consult sales.

Extraction procedures

U01 HOW TO USE TOOL R282 920 010

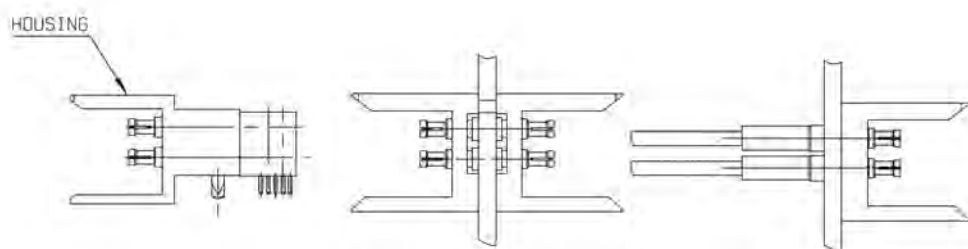

Inserts	Pre-assembled modules	
R199 001 203	R694 251 111	R694 251 115
R199 001 223	R694 251 112	R694 251 116
R199 001 733	R694 251 113	R694 251 117
	R694 251 114	

- Place the extraction tool as shown (upper coaxial contact only for twin coax) and push in axial direction into the housing until it stops.
- Then press gently on the rod to remove the contact from the rear of the housing.

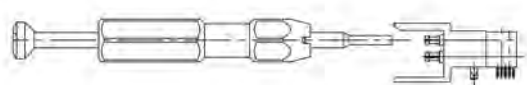

U02 HOW TO USE TOOL R282 920 100

Kits	Inserts
R285 930 005	R199 001 003
R694 252 507	R199 001 023
R694 252 537	R199 001 053
R694 252 557	

- Use a screw-driver to remove the cover from the housing as shown.
- Slide the cover along the cable.
- Place the extraction tool (as shown) and push in axial direction into the housing until it stops.
- Then press gently on the piston to remove the contact from the rear of the housing.

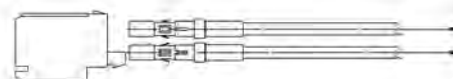
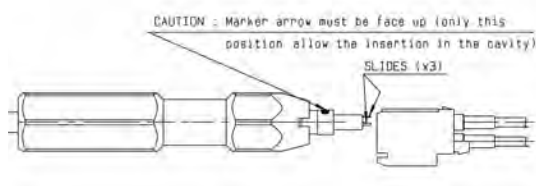
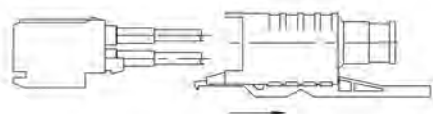
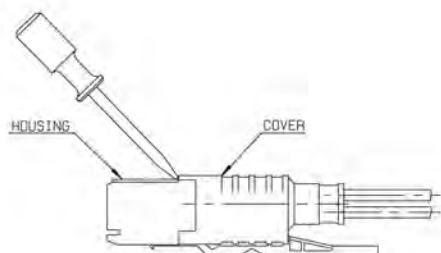



**Switching Connectors / Moebius
MC-Card / RP-MCX**

R199 / R299



Contents

Introduction 5-4 to 5-5

MOEBIUS

Characteristics 5-6

Receptacles 5-7

Switching connectors 5-7

Plugs 5-8

Adapters 5-8

PCB pattern 5-8

MC-CARD

Characteristics 5-9

Plugs 5-10

SMT Receptacle 5-10

SMT Switches 5-11

Adapters 5-11

Assembly instructions 5-12

PCB pattern 5-12

RP-MCX

Interface 5-13

SMT Switches 5-13

RF POWER SWITCHING CONNECTORS

QMA Type 5-14

N Type 5-15

SMA Type 5-14

QN Type 5-15

TNC Type 5-14

SECTION 5 TABLE OF CONTENTS

Introduction

Radiall offers a complete range of switching connectors that consists of four families:

- Microminiature, Moebius, for high life cycle mobile applications
- Microminiature, MC-Card, for mobile applications
- Reverse polarity MCX
- Power, for infrastructure applications



Microminiature Moebius: Designed for life

We chose Moebius in reference to the Möbius strip, as the origin of the infinity symbol. It is a good illustration for the very high durability performance of the Moebius connector. The Moebius interface is designed to be used as an antenna connection for handheld and mobile computing devices. The switching connector provides high RF performance and it is extremely durable and reliable as a snap-on connection.

Microminiature MC-Card

The MC-Card series are micro miniature, 50Ω connectors that feature snap-on mating and a frequency range of –8 GHz. The MC-Card series was designed by Radiall in the 90s. With the success of the switching version, it made the MC-Card an excellent alternative to MMCX connectors for numerous wireless and telecom applications. In addition, the MC-Card series offers similar performance as the MMCX by featuring quick snap-on mating and unmating withstanding a minimum of 5,000 mating cycles.

The globally adopted switching connector version consists of a female edge card receptacle with an integrated switch for SMT assembly. It allows for automatic switching between two RF signal paths. This connector is mainly used for wireless PCMCIA-Cards or GPS devices to switch between the internal antenna and a higher-gain external antenna.

In addition to the standard MC-Card series, Radiall also offers a 3mm dia. MC-Card. With this version, wireless equipment can be differentiated and protected against wrong antenna connections.



Introduction

Reverse Polarity MCX

This switching connector is available in straight SMT version and can be placed anywhere on the PCB. Reverse polarity MCX connectors must be used to activate the switch function. It is not compatible with standard MCX.

Power switching connectors

RF power switching connectors are surface/edge mountable. It's a two in one solution replacing the existing standard RF switches by integrating the switch function into a connector. This solution provides a unique means of switching between two RF signal paths. The switch is mechanically activated by mating and unmating the connector.

MAIN ADVANTAGES

- Reliable
- Increases the density
- Excellent electrical and mechanical performance
- Cost savings
- Available in a right or left version
- Many interfaces available: N, TNC, SMA, QN, QMA and more

MAIN APPLICATIONS

- Telecom base station equipment
- RF power amplifiers

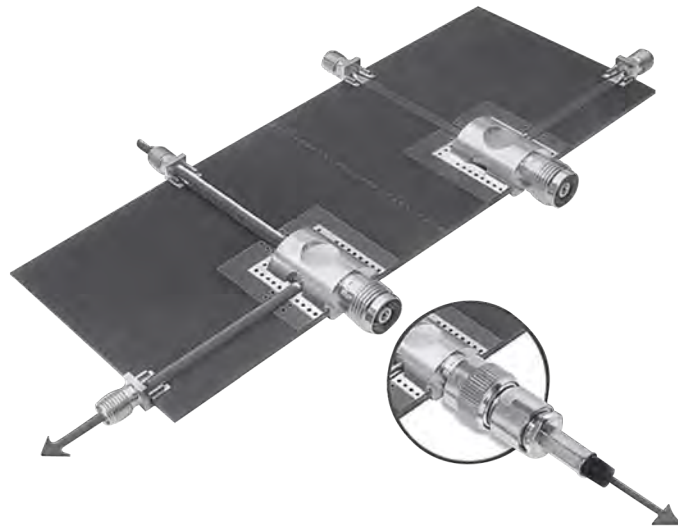

Characteristics

	Not mated	Mated
Operating temperature range	-40°C to + 110°C	
Rated power	10 W / 900 MHz	
DC Current Withstanding	1 A max	
Frequency range	DC to 6 GHz	
V.S.W.R.	1.20 max DC to 3 GHz 1.50 max 3 to 6 GHz	1.15 max DC to 3 GHz 1.25 max 3 GHz to 6 GHz
Insertion loss	0.15 dB max DC to 2 GHz 0.20 dB max 2 GHz to 3 GHz 0.40 dB max 3 GHz to 6 GHz	0.10 dB max DC to 2 GHz 0.15 dB max 2 GHz to 3 GHz 0.20 dB max 3 GHz to 6 GHz
Isolation loss	- - -	35 dB minDC to 1 GHz 25 dB min 1 GHz to 3 GHz 25 dB min 3 GHz to 6 GHz

Item	Specification	Conditions
Contact resistance	200 mΩ max	100 mA
Insulation resistance	3000 MΩ min	250 V DC
Withstanding voltage	No flashover or insulation breakdown	250 V rms
Vibration	No discontinuities > 1μs under 100mA	Sinus: 5-500Hz / displacement 0.75 peak / acceleration 10 g duration 2h in each direction Random: 5-1000Hz / displacement 0.75 peak / acceleration 3.3 g duration 1h in each direction 25 dB min 3 GHz to 6 GHz
Shock	No discontinuities > 1μs under 100mA	Acceleration 50 g / duration pulse 11 ms / waveform pulse half sinus / number of shocks 3 per direction
Free fall	Center contact resistance RF measurements No discontinuities > 1 ms under 100mA	NFC 20732 method 1 Test area concrete / fall height 1 m / duration 2*2 falls
Temperature life	Center contact resistance RF measurements	T + 90°C / duration 1000 h / 40% HR
Thermal shock	Center contact resistance RF measurements	T - 40°C to + 90°C Exposure 15mn / transfert time < 10 s / 100 cycles
Damp heat	Center contact resistance RF measurements	40°C / 93% / 21 days
Retention Force • Insertion Force - mating • Extraction Force - unmating	9N 12N	Initial
Durability	Mating - unmating force Center contact resistance RF measurements	25.000 cycles

MATERIALS AND PLATING

	Material	Plating
Body	Brass	NPGR
Center contact		
Outer contact		
Insulator	PTFE / nc	
Others parts	Beryllium copper	NPGR

Receptacle and switching connector

RECEPTACLE

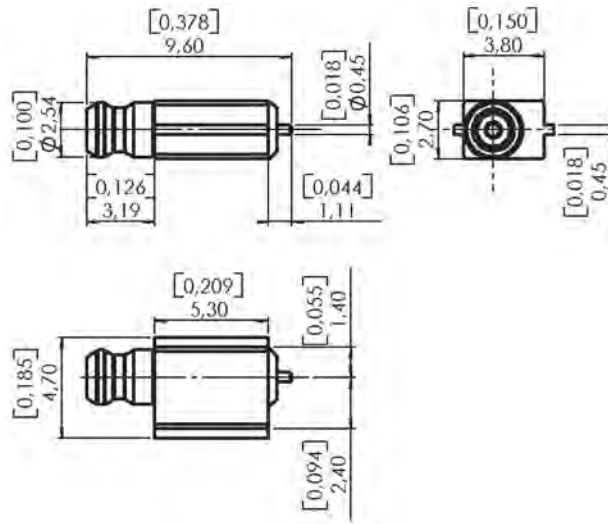

Part number	Packaging	RoHS
R199 006 413	100 pieces/reel	yes

SWITCHING CONNECTOR

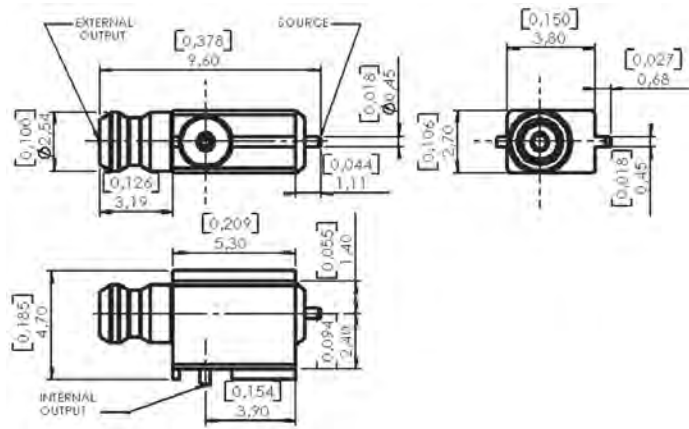

Part number	Packaging	RoHS
R199 006 813	100 pieces/reel	yes



Plugs, adapter and PCB pattern

STRAIGHT AND RIGHT ANGLE PLUGS

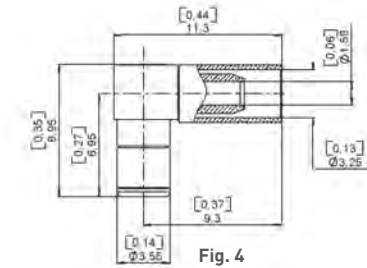
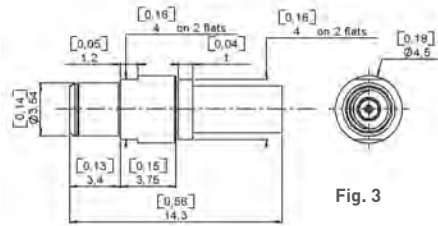
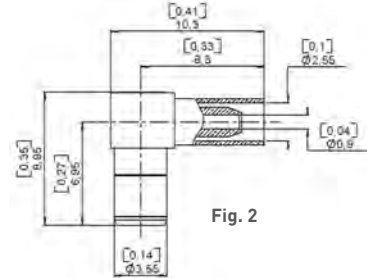
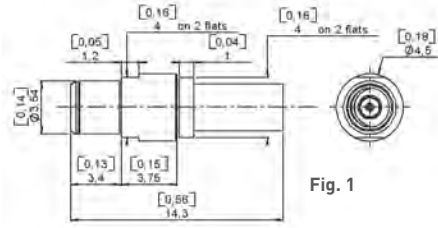

Cable group	Cable group dia.	Part number	Fig.	Packaging	RoHS
RG178 / RG196	2/50/S	R199 006 203	1	100/Box	yes
		R199 006 213	2		
RG174 / RG316	2.6/50/S	R199 006 263	3		
		R199 006 273	4		

SMA ADAPTER

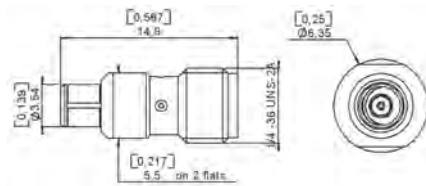

Part number	Packaging	RoHS
R191 857 000	Unit	yes

PCB pattern

P01

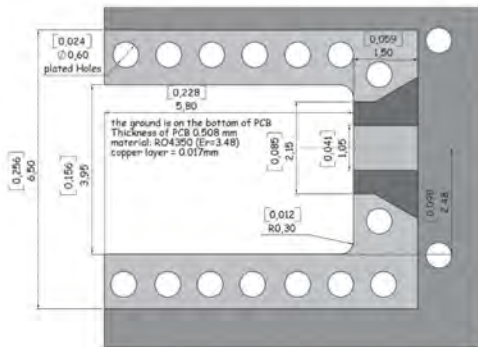

Receptacles

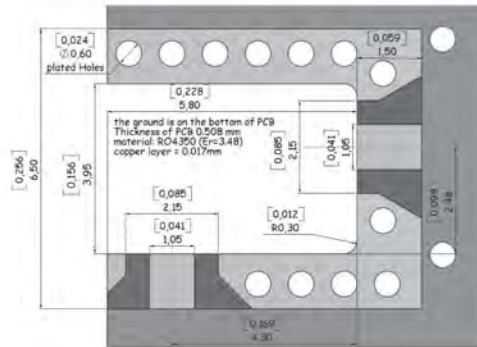

Switching Connectors

Characteristics

Test / Characteristics	Values / Remarks
------------------------	------------------

ELECTRICAL CHARACTERISTICS

Impedance	50Ω				
Frequency range	Connectors: DC - 8 GHz Switch: DC - 3 GHz				
Typical V.S.W.R. • Straight models - 2/50 cable • Right angle models - 2/50 cable - 2.6/50 cable	1	2.5	4	6	8
	1.07	1.15	1.16	1.17	1.25
	1.08 1.05	1.17 1.08	1.22 1.10	1.26 1.13	1.30 1.12
Insertion loss (dB) • Straight connectors • Right angle connectors	0.04	0.08	0.11	0.15	0.15
	0.05	0.10	0.15	0.20	0.25
RF leakage (dB max)	-65 dB max at 8 GHz				
Insulation resistance	5000 MΩ min				
Contact resistance • Center contact • Outer contact	1.5 mΩ				
	0.2 mΩ				
Working voltage in V.R.M.S. • At sea level (at 21000 m)	170				
Dielectric withstanding voltage in V.R.M.S. • At sea level	500				
RF testing voltage sea level in V.R.M.S.	500				

MECHANICAL CHARACTERISTICS

Durability	5000 matings
Force to engage and disengage	6.2 N
Force to disengage	8.8 N
Cable retention force • 2/50 cable • 2.6/50 cable	58 N
	110 N
Center contact retention force	slide-on

ENVIRONMENTAL CHARACTERISTICS

Temperature range • Switches • Others	-40°C / +110°C
	-25°C / +125°C
Thermal cycling test	MIL STD 202, method 107, condition B
High temperature endurance	MIL STD 202, method 108
Corrosion (salt spray)	MIL STD 202, method 101, condition B
Vibration	MIL STD 202, method 204, condition B
Shock	MIL STD 202, method 213, condition G
Moisture resistance	MIL STD 202, method 106
Hermeticity	MIL STD 202, method 112, condition C
	Vacuum 10 ⁻⁶ Hgmm (Torr) Leakage rate 10 ⁻⁶ atm / cm ³ / s
Barometric pressure	Pressure test: 3.5 bars; duration: 2 mn; Temperature: 15°C to 25 °C

MATERIALS

Bodies	Brass
Center contact • Male • Female	Brass
	Bronze or heat treated Beryllium following QQ-C-530
Insulator • Cable connectors • Switches	PTFE
	Polyether ethercetone 30% GF
Gasket	Silicon rubber

PLATING

Bodies • Cable connectors • SMT receptacles • Edge card receptacles • Switches	Nickel or BBR
	Gold
	Gold
	Gold
Center contacts	Gold

Plugs and SMT receptacle

STRAIGHT PLUGS

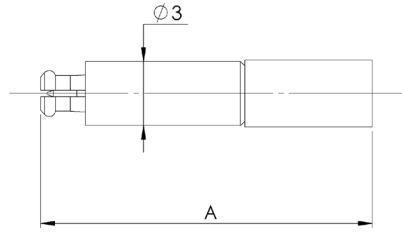

Cable group	Cable group dia.	Part number	Dimensions A (mm)	Captive center contact	Finish	Note
RG178 / RG196	2/50/S	R199 005 200	15.6	no	Nickel	Crimp type
RG405	.085"	R199 005 223	10.1	yes	Gold	Solder type

RIGHT ANGLE PLUGS

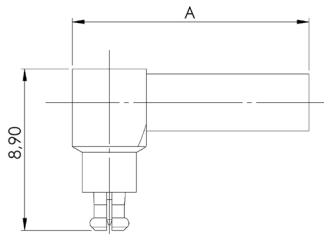

Cable group	Cable group dia.	Part number	Dimensions A (mm)	Captive center contact	Finish	Note
-	1/50/S	R199 005 310*	9.1	yes	Gold	MC-CARD 3mm dia.
RG178 / RG196	2/50/S	R199 005 240	13.1		Nickel	Crimp type
RG174 / RG316	2.6/50/S	R199 005 250	7.8		Gold	Solder type
RG405	.085"	R199 005 273				

*Specific 3 mm interface = not compatible with standard interface plug

SMT RECEPTACLE

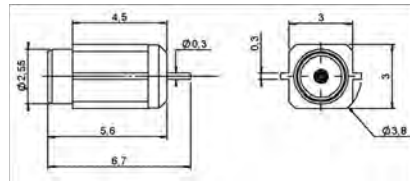

Fig. 1

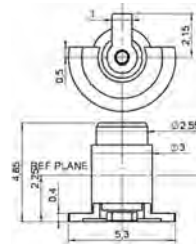

Fig. 2

Part number	Fig.	Captive center contact	Assembly instructions	PCB pattern	Finish	Packaging
R199 005 800	1	yes	M01	P02	Gold	400 pieces/reel
R199 005 820	2					100 piece/reel

SMT Switches and adapters

SMT SWITCHES

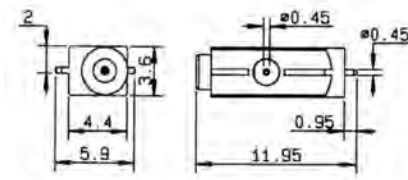

Fig. 1

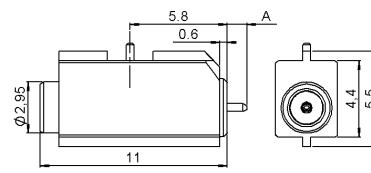

Fig. 2

Part number	Fig	Dimension A (mm)	Captive center contact	Assembly instructions	PCB pattern	Finish	Packaging	Note
R199 005 890	1		yes	M01	P01	Gold	500 pieces/reel	
R299 794 800*	2	0.93						MC-CARD 3mm dia.

*Specific 3 mm interface = not compatible with standard interface plug

Electrical diagram on "M01"

BETWEEN SERIES ADAPTERS

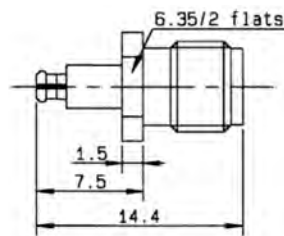

Fig. 1

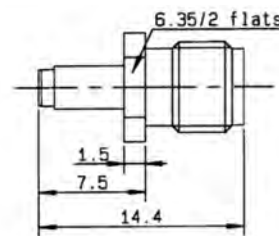

Fig. 2

Part number	Fig.	Series	Body and finish
R191 366 071	1	SMA female / MC CARD male	Passivated stainless steel
R191 366 091	2	SMA female / MC CARD female	

Assembly instructions

M01

ELECTRICAL DIAGRAM

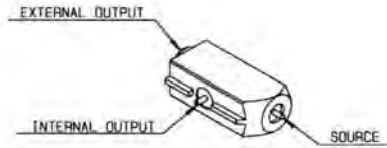

Part number	Step 1	Step 2
R199 005 890 R299 794 800	<p>UNMATED CONNECTOR</p>	<p>MATED WITH MC CARD PLUG</p>

VIDEO SHADOW AND ASPIRATION AREA

Part number	Video shadow of receptacle	Aspiration area
R199 005 800		
R199 005 890 R299 794 800		

*2.95 for: R299 795 830 - R299 794 800

PCB pattern

P01

Part number

R199 005 890
R299 794 800

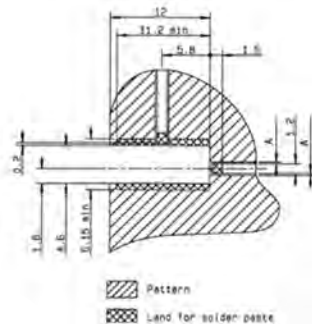

P02

Part number

R199 005 800

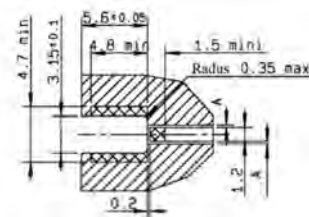

PCB thickness (mm)	Coplanar line A (mm)
0.8	0.183
1.0	0.190
1.2	0.195
1.6	0.200

Interface

PLUG

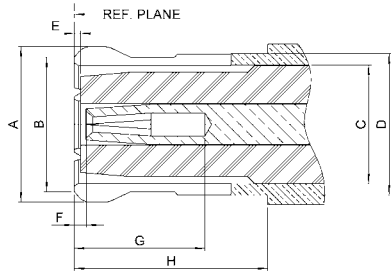

JACK

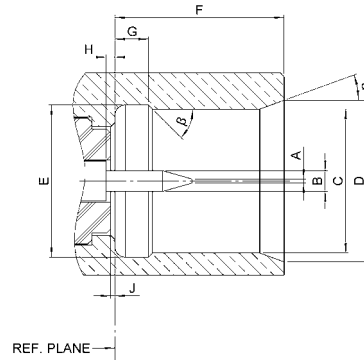

Letter	mm		inch	
	min.	max.	min.	max.
A DIA		3.80		.150
B DIA		3.60		.142
C DIA		3.00		.118
D DIA		3.40		.134
E	0		0	.004
F	0		0	.008
G	2.60		.110	
H	4.15		.163	

Letter	mm		inch	
	min.	max.	min.	max.
A DIA	3.15	3.20	.124	.126
B DIA	2.74	2.84	.108	.112
C DIA	0.52	0.60	.0205	.0235
D DIA	0		0	
E DIA	1.14	1.40	.045	.055
F	0.36	0.41	.014	.016
G	3.53	3.68	.139	.145
H			0	
J			0	
a	18°	22°	18°	22°
b	43°	47°	43°	47°

SMT switches

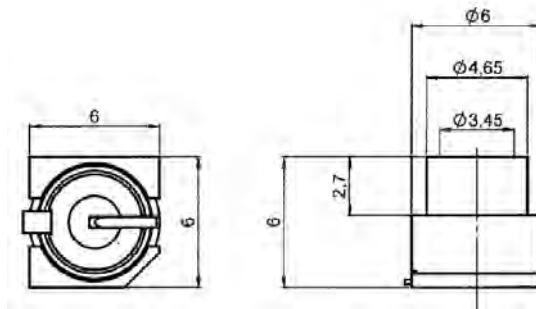

Part number	Finish	Packaging
R299 137 800	Gold	Tape & Reel 200 pieces
R299 137 801		Tape & Reel 900 pieces

RF power switching connectors

Test / Characteristics	Values / Remarks				
------------------------	------------------	--	--	--	--

ELECTRICAL CHARACTERISTICS

	QMA	QN	SMA	N	TNC
Impedance	50Ω				
Frequency range	DC - 3 GHz				
Typical V.S.W.R.	1.1 + 0.1000 x F (GHz) Maxi	1.1 + 0.1000 x F (GHz) Maxi	1.1 + 0.1000 x F (GHz) Maxi	1.1 + 0.1000 x F (GHz) Maxi	
Isolation at					
• DC to 1 GHz	- 47 dB typical				
• 1 to 2 GHz	- 43 dB typical				
• 2 to 3 GHz	- 40 dB typical				
Insertion Loss at					
• DC to 1 GHz	- 0.1 dB maxi				
• 1 to 2 GHz	- 0.15 dB maxi				
• 2 to 3 GHz	- 0.2 dB maxi				
RF leakage	NA	NA	NA	NA	
Voltage rating	300 Veff maxi				
Dielectric withstanding voltage	500 Veff mini				
Insulation resistance	5000 MΩ mini				
Power withstanding	110 W (at 2 GHz)	110 W (at 2 GHz)	50 W (at 1.8 GHz)	100 W (at 1.8 GHz)	50 W (at 1.9 GHz)

QMA TYPE

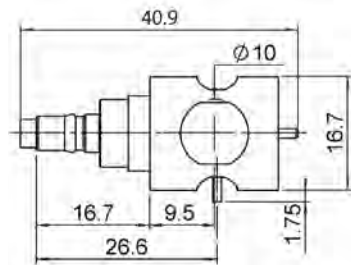

Part number	Type
R123 422 801	Right

SMA TYPE

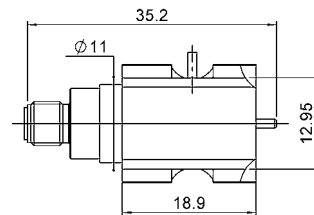

Part number	Type
R124 422 001	Right

TNC TYPE

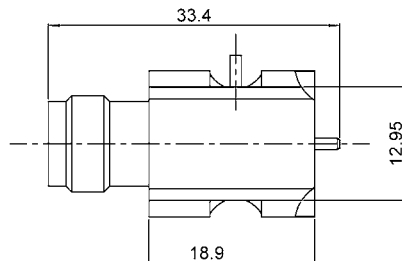

Part number	Type
R143 422 947	Left
R143 422 957	Right

RF power switching connectors

Test / Characteristics	Values / Remarks
------------------------	------------------

N TYPE

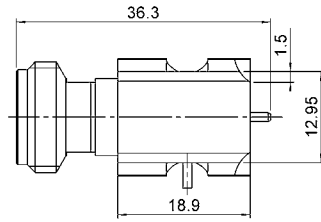

Part number	Type
R161 428 223	Left
R161 428 233	Right

QN TYPE

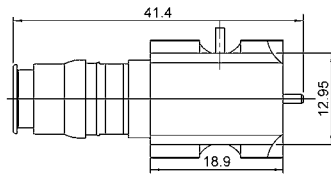

Part number	Type
R164 428 823	Left
R164 428 833	Right

RF POWER SWITCHING CONNECTORS

SECTION 6



SMB / SMB-LOCK / SMC
R114 / R117 / R112



Contents

SMB

Introduction 6-4 to 6-5
Interface 6-6
Characteristics 6-7 to 6-8
Plugs 6-8 to 6-11
Jacks 6-10 to 6-12
Bulkhead jacks 6-12 to 6-14
Receptacles 6-14 to 6-15
PCB receptacles 6-15 to 6-16
Adapters 6-17
Panel drilling 6-22
Assembly instructions 6-22

SMB-LOCK

Introduction 6-18
Interface 6-18
Characteristics 6-19
Plugs 6-20

SMB LIMITED DETENT (SMB-A)

Receptacles 6-21

SMB SLIDE-ON (SUBGLIS)

Plugs and receptacles 6-21

SMC

Introduction 6-23
Interface 6-23
Characteristics 6-24
Plugs 6-25
Jacks 6-25 to 6-27
Receptacles 6-27 to 6-28
Adapters 6-28
Panel drilling 6-28

Introduction

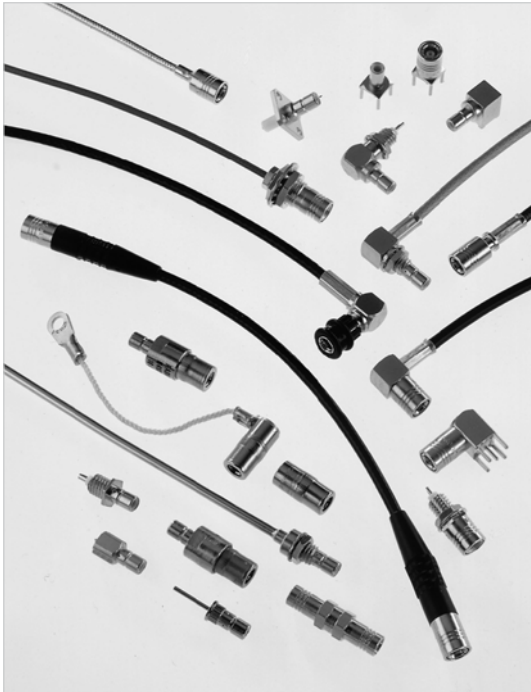

50Ω

DC - 4 GHz

GENERAL

- Subminiature coaxial connectors
- Snap-on coupling
- Plugs have female contacts
- Jacks have male contacts
- Low weight and reduced outline dimensions
- Captive contact (except contrary specification)

APPLICABLE STANDARDS

- SMB series MIL-C-39012
MIL-C-39012/67-72
- IEC 169-10
- CECC 22130
- BS 9210 N0007

APPLICATIONS

- Mobile communication systems
- Civil and military telecommunications
- Aeronautics
- Automotive

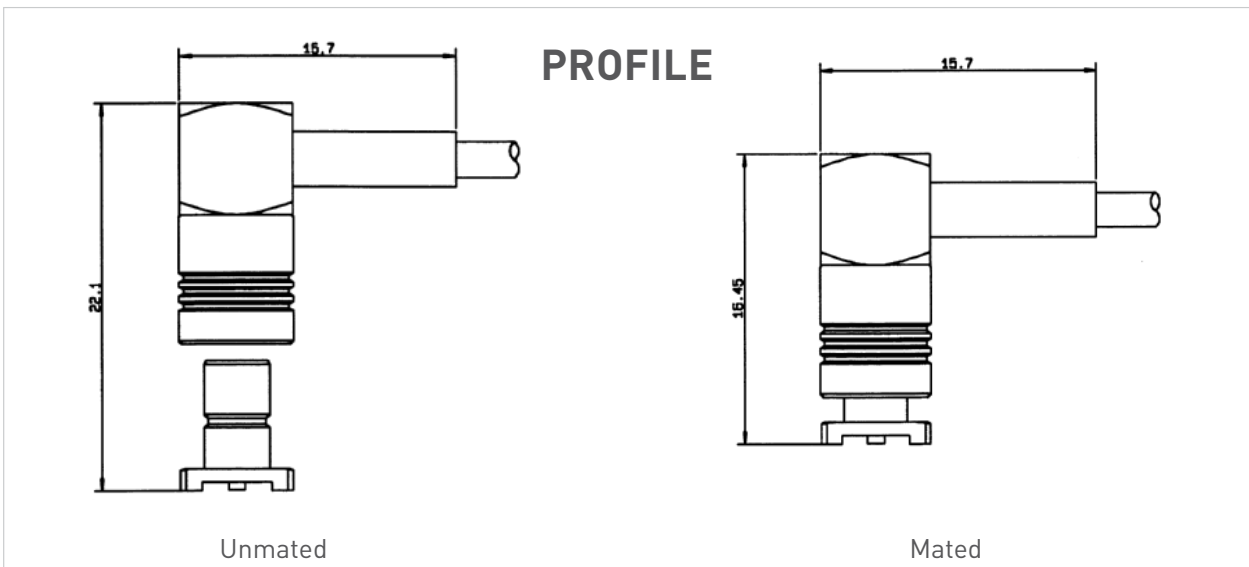

Introduction

SMB snap-on subminiature coaxial connectors provide a fast and reliable connection for high density packaging for applications up to 4 GHz.

Radiall offers a very large range of SMB connectors, including cable plugs and jacks with bulkhead and panel mount configurations, bulkhead and panel mount receptacles; through hole, SMT and edge card receptacles and in-series and between series adapters.

SMB series also features versions with lower mating forces than standard. Four types of interconnection mechanisms are available:

- **SMB: Standard** snap-on connection
The design permits quick engagement and disengagement.
- **SMB limited detent (SMB-A):** Snap-on connection with **low mating force**
The design permits quick engagement and disengagement, and is suitable for printed circuit boards. Radiall offers a range of PCB and bulkhead receptacles with female center contact. The SMB-A receptacles are completely intermateable with standard SMB jacks.
- **SMB slide-on (SUBGLIS):** Slide-on connection
The design is suitable for back plane and blind mate applications. In this case, we recommend the association of a mobile connector (floating jack / receptacle) with a fixed connector (panel plug / jack, receptacle). The SUBGLIS connectors are completely intermateable with standard SMB and SMB-A connectors and for that, they can be used for test applications.
- **SMB Lock:**
Plugs (with female center contact) have a coupling nut allowing a reliable lock-on connection (50 N min). This range allows a visual control of the locking system.



These four types of SMB connectors have the same electrical performances.

PLUG (with female contact)

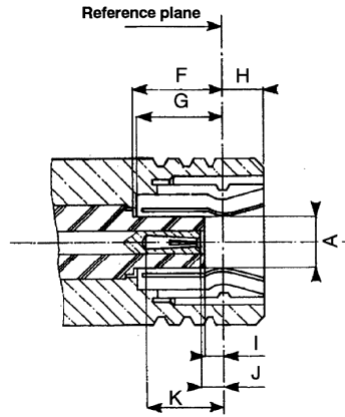

JACK (with male contact)

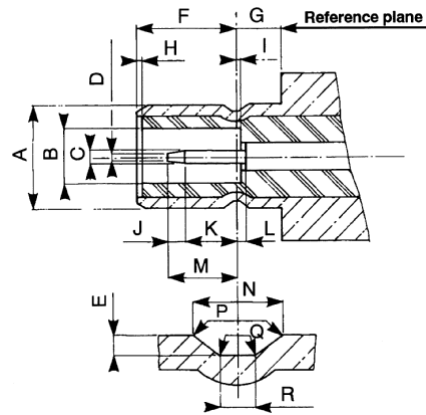

Letter	mm		inch	
	min.	max.	min.	max.
A DIA		2.06		.081
F	3.58		.141	
G	3.58		.141	
H		1.63		.064
I	0.18		.007	
J	0.18	0.94	.007	.037
K	2.97		.117	

Letter	mm		inch	
	min.	max.	min.	max.
A DIA		3.71		.146
B DIA	2.08		.082	
C DIA	0.48	0.53	.019	.021
D DIA		0.25		.010
E	0.15	0.25	.006	.010
F	3.33	3.58	.131	.141
G	1.65		.065	
I		0.18		.007
J	0.25		.010	
K	1.32		.052	
L		0.18		.007
M		2.97		.117
N	0.69	0.94	.027	.037
P	0.05	0.15	.002	.006
Q		0.13		.005
R	0.28	0.38	.011	.015

CLAMP TYPE CONNECTORS: R 114 xxx 000 = braid retention with cylindrical gasket
 R 114 xxx 133 = braid retention with V groove gasket

Characteristics

Test / Characteristics	MIL-C-39012 A	Values / Remarks
------------------------	---------------	------------------

ELECTRICAL CHARACTERISTICS

Impedance		50Ω				
Frequency range		DC - 4 GHz				
V.S.W.R. (typ.) • Straight models • Right angle models	cable group: .085"	Frequency	3-14	1 GHz	2.5 GHz	4 GHz
		2		1.12	1.22	1.33
	2.6		1.10	1.22	1.33	
	2		1.12	1.22	1.35	
	.085"		1.10	1.18	1.26	
	2		1.10	1.20	1.25	
Insertion loss (typ.) dB • Straight models • Right angle models	cable group: .085"		3-27	0.05	0.07	0.15
		2		0.05	0.10	0.25
	2.6		0.05	0.05	0.05	
	2		0.05	0.07	0.12	
	.085"					
	2					
RF leakage		3-26			-55 dB min from 2 to 3 GHz	
Insulation resistance		3-11			1000 MΩ min	
Contact resistance		3-16			Initial	After test
• Center contact (mΩ)					6	8
• Outer contact (mΩ)					1	1.5
Working voltage						
• Cable group					2/50	2.6/50
• At sea level					250 V rms	335 V rms
• At 70000 ft (21000 m)					60 V rms	85 V rms
Dielectric withstanding voltage						
• Cable group		3-17			2/50	2.6/50
• At sea level					750 V rms	1000 V rms
• At 70000 ft (21000 m)					185 V rms	250 V rms
RF withstanding voltage (5 MHz sine wave)						
• Cable group		3-23			2/50	2.6/50
• At sea level					500 V rms	700 V rms

MECHANICAL CHARACTERISTICS

Durability	3-15	500 matings
Mating / Unmating	3-5-1	Axial force: 62 N max (14 Lbf)
Cabling retention force	cable group: • 2/50 • 2.6/50	3-24
		58 N (13Lbf) 110 N (25Lbf)
Center contact retention		Axial: 10 N (2.25 Lbf)

ENVIRONMENTAL CHARACTERISTICS

Temperature range		-65°C / + 165°C -65°C / +165°C -65°C / +105°C
• Standard models		
• Hermetic sealed models		
• Models for semi-rigid cables		
Combined climate tests		MIL-STD-202, method 102, condition C
Thermal shock	3-20	MIL-STD-202, method 107, condition B
High temperature endurance		MIL-STD-202, method 108
Corrosion (salt spray)	3-13	MIL-STD-202, method 101, condition B, 5%
Vibrations	3-18	MIL-STD-202, method 204, condition B, 15g
Shocks	3-19	MIL-STD-202, method 213, condition B, 75g
Low pressure	3-22	MIL-STD-202, method 105, condition C
Hermetic seal		Applied vacuum 10 ⁻⁶ mm of Hg (Torrs) Leakage rate < 10 ⁻⁶ atm/cm ³ /s

MATERIALS AND PLATING

	Material	Plating
Body and center pin contact	Half hard brass as per QQ-B-626	Gold or nickel (Body)
Center socket contact	Beryllium copper as per QQ-C-530	Gold (Center contact)
Ferrules	Brass	
Insulators	PTFE teflon	
Gaskets	Silicone elastomer	

Standard packaging: 100 pieces

All dimensions are given in mm.

Characteristics

POWER RATING

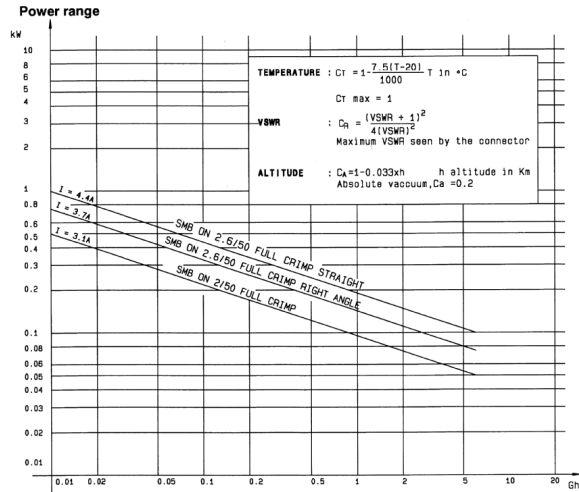

Plugs

STRAIGHT PLUGS CRIMP TYPE FOR FLEXIBLE CABLES

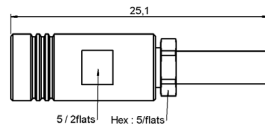

Fig. 1

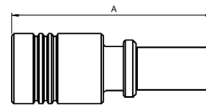

Fig. 2

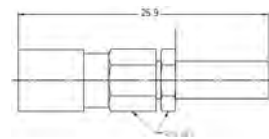

Fig. 3

Cable group	Cable group dia.	Part number	Fig.	Dimensions A (mm)	Captive center contact	Finish	Note
RG178 / RG196	2/50/S	R114 073 000	1			Gold	
RG174 / RG316 / RG179	2.6/50+75/S	R114 075 000					
		R114 082 000	2	19.8			Full crimp
RD316	2.6/50/D	R114 083 000		18.4			
RG178 / RG196	2/50S	2002-1571-002	3		yes	Nickel	
		2002-7571-002					
RD178	2/50D	2002-1571-005					
		2002-7571-005					
RG174 / RG316	2.6/50S	2002-1571-003					
		2002-7571-003					
RD316	2.6/50D	2002-1571-019				Gold	
		2002-7571-019				Nickel	

Plugs and jacks

STRAIGHT PLUGS CLAMP TYPE FOR FLEXIBLE CABLES

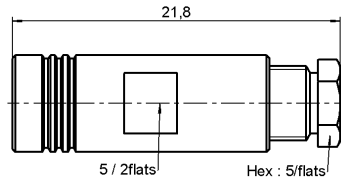

Fig. 1

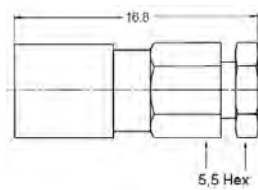

Fig. 2

Cable group	Cable group dia.	Part number (Gold)	Part number (Nickel)	Fig.	Captive center contact
RG178 / RG196	2/50/S	R114 003 000	n/a	1	yes
RG174 / RG316 / RG179	2.6/50+75/S	R114 005 000			
RG178 / RG196	2/50S	2002-1551-002	2002-7551-002	2	
RD178	2/50D	2002-1551-005			
RG174 / RG316	2.6/50S	2002-7551-003	2002-7551-003		
RD316	2.6/50D	2002-7551-019	2002-7551-019		

STRAIGHT PLUG FOR SEMI RIGID CABLES

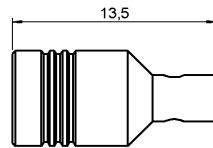

Fig. 1

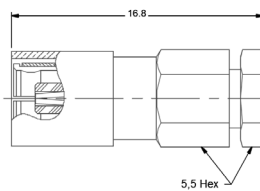
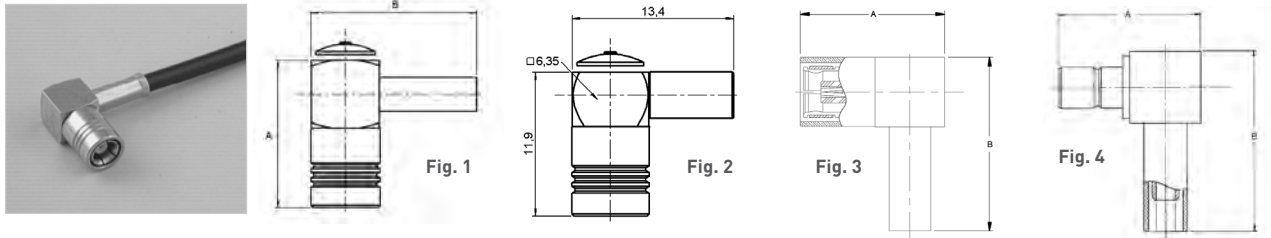

Fig. 2

Cable group	Cable group dia.	Part number (Gold)	Part number (Nickel)	Fig.	Captive center contact	Note
RG405	.085"	R114 053 000		1	no	Solder type
		2002-1541-010	2002-7541-010	2	yes	Solder clamp
RG402	.141"	2002-1541-003	2002-7541-009			

Plugs and jacks

RIGHT ANGLE PLUGS AND JACKS CRIMP TYPE FOR FLEXIBLE CABLES



Cable group	Cable group dia.	Part number (Gold)	Part number (Nickel)	Fig.	Dimensions mm		Captive center contact	Note	
					A	B			
RG178 / RG196	2/50/S	R114 183 000		1	13.7	15.3			
RG174 / RG316 / RG179	2.6/50+75/S	R114 185 000		2				Short version	
		R114 186 000	n/a	1	13.7	15.3			
		R114 186 100			15.1	15.4		Full crimp	
		R114 187 000			13.7				
RD316	2.6/50/D	R114 182 000							
RG178 / RG196	2/50S	2105-1521-002	2105-7521-002	3	13.2	16	yes		
		2141-1521-002		4	12.7				
RD178	2/50D	2105-1521-005	2105-7521-005	3	13.2				
RG174 / RG316 / RG179	2.6/50S	2105-1521-003	2105-7521-003	3	13.2				
		2141-1521-003	2141-7521-003	4	12.7				
RD316	2.6/50D	2105-1521-019	2105-7521-019	3	13.2				
		2141-1521-019	2141-7521-019	4	12.7				

Plugs and jacks

RIGHT ANGLE PLUGS AND JACKS CLAMP TYPE FOR FLEXIBLE CABLES

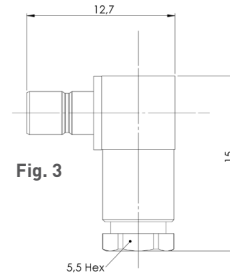
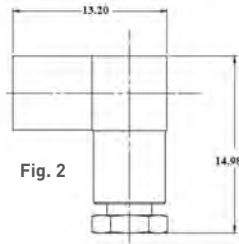
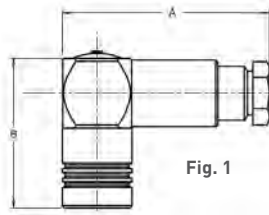

Cable group	Cable group dia.	Part number (Gold)	Part number (Nickel)	Fig.	Dimensions mm		Captive center contact
					A	B	
RG178 / RG196	2/50/S	R114 163 000	n/a	1	19	13.7	yes
	2.2/50/D	R114 163 420			16.7		
RG174 / RG316 / RG179	2.6/50+75/S	R114 165 000			19		
RG178 / RG197	2/50S	2005-1551-002	2005-7551-002	2			
		2041-1551-002		3			
RG174 / RG316 / RG179	2.6/50S	2005-1551-003	2005-7551-003	2			
		2041-1551-003	2041-7551-003	3			
RD316	2.6/50D	2005-1551-019		2			

RIGHT ANGLE PLUGS AND JACKS FOR SEMI RIGID CABLES

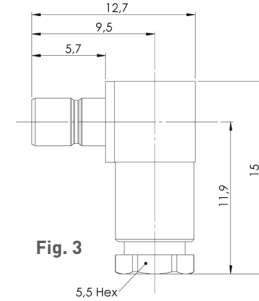
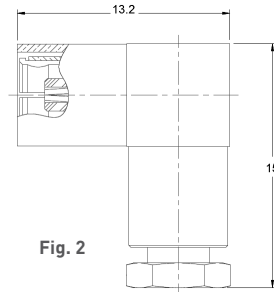
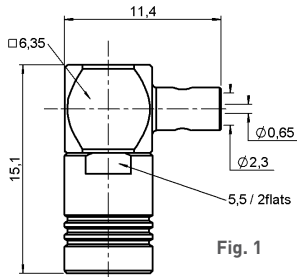

Cable group	Cable group dia.	Part number (Gold)	Part number (Nickel)	Fig.	Captive center contact	Note
RG405	.085"	R114 169 000	n/a	1	yes	Cable bending required Solder type for semi rigid cable
		2005-1541-010	2005-7541-010	2		
		2041-1541-010	2041-7541-010	3		
RG402	.141"	2005-1541-009	2005-7541-009	2		Solder clamp
		2041-1541-009		3		

Jacks and bulkhead jacks

STRAIGHT JACKS CRIMP TYPE FOR FLEXIBLE CABLES

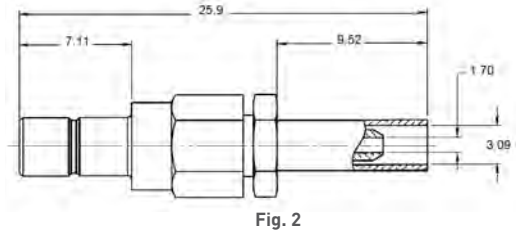
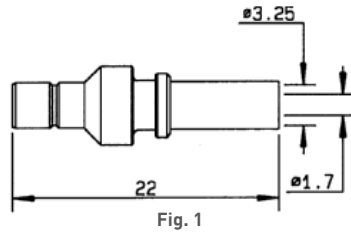

Cable group	Cable group dia.	Part number (Gold)	Part number (Nickel)	Fig.	Captive center contact	Note
RG174 / RG316 / RG179	2.6/50+75/S	R114 238 000		1	yes	Full crimp
RG178 / RG197	2/50S	2001-1571-002	2001-7571-002	2		yes
RD178	2/50D	2001-1571-005				
RG174 / RG316 / RG179	2.6/50S	2001-1571-003	2001-7571-003			
RD316	2.6/50D	2001-1571-019	2001-7571-019			

STRAIGHT BULKHEAD JACKS CRIMP TYPE FOR FLEXIBLE CABLES

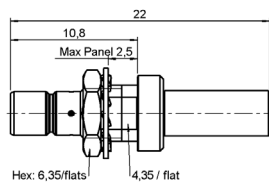

Fig. 1

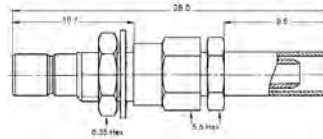

Fig. 2

Cable group	Cable group dia.	Part number (Gold)	Part number (Nickel)	Fig.	Captive center contact	Panel drilling	Note
RG174 / RG316 / RG179	2.6/50+75/S	R114 313 000	n/a	1	yes	P08	Rear mount / Fill crimp
RG178 / RG197	2/50S	2003-1571-002	2003-7571-002	2			
RD178	2/50D	2003-1571-005	2003-7571-005				
RG174 / RG316 / RG179	2.6/50S	2003-1571-003	2003-7571-003				
RD316	2.6/50D	2003-1571-019	2003-7571-019				

Bulkhead jacks

SMB

STRAIGHT BULKHEAD JACKS CLAMP TYPE FOR FLEXIBLE CABLES

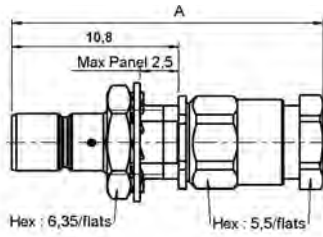

Fig. 1

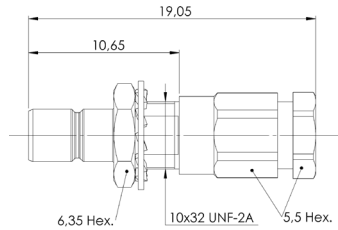

Fig. 2

Cable group	Cable group dia.	Part number (Gold)	Part number (Nickel)	Fig.	Dimensions A (mm)	Captive center contact	Panel drilling	Note
RG178 / RG196	2/50/S	R114 303 000	n/a	1	25.3	yes	P08	Rear mount
		R114 303 133			20.1			
RG174 / RG316 / RG179	2.6/50+75/S	R114 305 000	25.3					
RG178 / RG197	2/50/S	2003-1551-002	2003-7551-002	2				
RD178	2/50/D	2003-1551-005						
RG174 / RG316 / RG179	2.6/50/S	2003-1551-003	2003-7551-003					
RD316	2.6/50/D	2003-1551-019						

STRAIGHT BULKHEAD JACK SOLDER TYPE FOR SEMI-RIGID CABLE

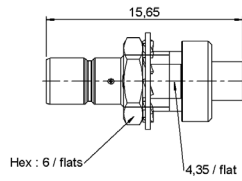

Fig. 1

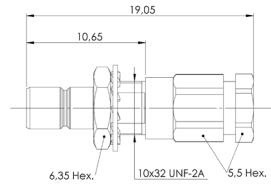
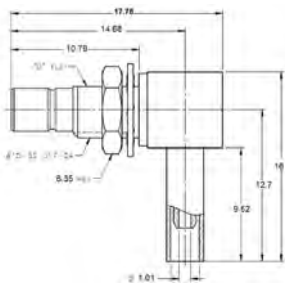

Fig. 2

Cable group	Cable group dia.	Part number (Gold)	Part number (Nickel)	Fig.	Captive center contact	Panel drilling	Note
RG405	.085"	R114 222 000	2003-7541-010	1	yes	P08	Solder clamp type
		2003-1541-010					
RG402	.141"	2003-1541-009	2				

RIGHT ANGLE BULKHEAD CRIMP TYPE FOR FLEXIBLE CABLES



Cable group	Cable group dia.	Part number (Gold)	Part number (Nickel)	Captive center contact	Panel drilling
RG178 / RG197	2/50S	2106-1521-002	2106-7521-002	yes	P08
RD178	2/50D	2106-1521-005			
RG174 / RG316 / RG179	2.6/50/S	2106-1521-003	2106-7521-003		
RD316	2.6/50/D	2106-1521-019	2106-7521-019		

Receptacles

STRAIGHT FLANGE RECEPTACLES (male center contact)

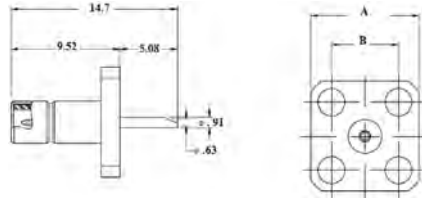
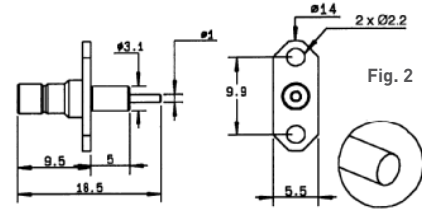
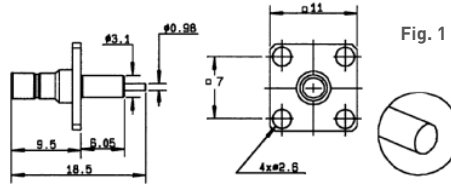

Fig. 3

Part number (Gold)	Part number (Nickel)	Fig.	Dimensions mm		Captive center contact	Panel drilling	Note
			A	B			
R114 413 000	n/a	1			no	P01	Square flange / Extended dielectric
R114 450 000		2				P06	2 hole glange / Extended dielectric / Unit packaging
2484-1511-000	2486-7511-000	3	9.5	5.9	yes		2.36mm hole dia.
2486-1511-000			12.7	8.6			

STRAIGHT BULKHEAD RECEPTACLES (male center contact)

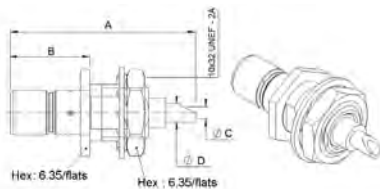

Fig. 1

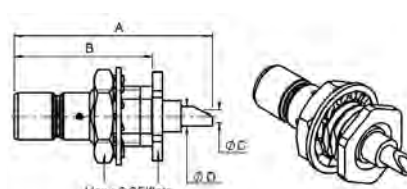

Fig. 2

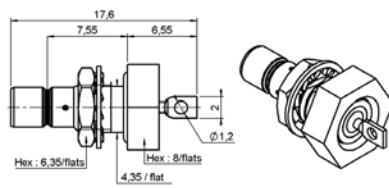

Fig. 3

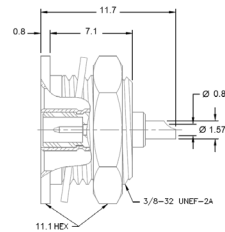
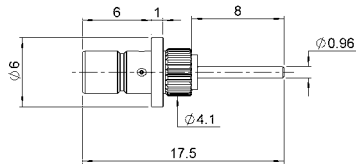

Fig. 4

Part number (Gold)	Part number (Nickel)	Fig.	Dimensions mm				Captive center contact	Panel drilling	Note
			A	B	C	D			
R114 553 000	n/a	1	15.7	6.7	1	1.5	yes	P08	Front mount
R114 554 000		2		10.9					Rear mount
R114 603 000		3							Hermetically sealed
2004-1511-000	2004-7511-000	2	15.5	10.8	0.9	1.6			Rear mount / Solder pot contact
2014-1511-000	2014-7511-000	4							Recessed front mount / Solder pot contact
2019-1511-000	2019-7511-000	1	15.5	5.9	0.9	1.6			Front mount / Solder pot contact

Receptacles

STRAIGHT PRESS IN RECEPTACLE (male)



Part number	Captive center contact	Panel drilling	Finish
R114 504 225	yes	P10	Nickel

RIGHT ANGLE BULKHEAD RECEPTACLES (male center contact)

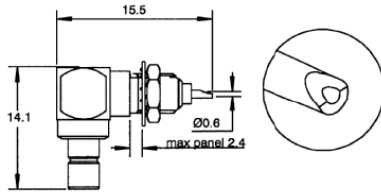

Part number	Captive center contact	Panel drilling	Finish	Note
R114 670 000	yes	P08	Gold	Solder pot contact
2012-1511-000			Nickel	
2012-7511-000				

STRAIGHT PCB RECEPTACLES (male and female)

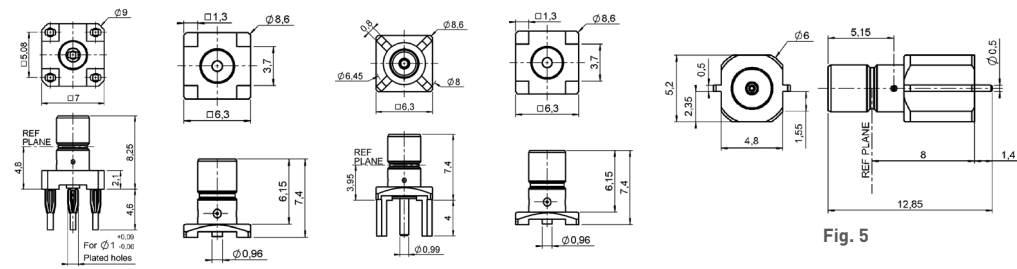

Fig. 1

Fig. 2

Fig. 3

Fig. 4

Fig. 5

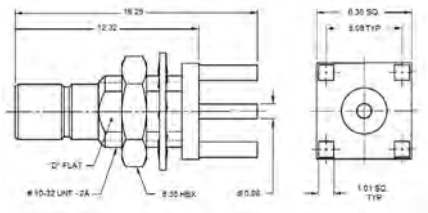

Fig. 6

Fig. 7

Part number (Gold)	Part number (Nickel)	Fig.	Captive center contact	Assembly instructions	Panel drilling	Note
R114 416 020	n/a	1	yes	M01	P02	Press fit pins
R114 423 000		5			SMT edge card	
R114 424 000		2			SMT	
R114 424 100					SMT / Tape & Reel 100 pieces	
R114 425 000		4			P05	Female plug
R114 426 000		3			P03	
2009-1511-000	2009-7511-000	3			P04	No standoff
2009-1511-050	2009-7511-050		Standoff legs			
2025-1511-000	2025-7511-000		7			
2109-1511-000	2109-7511-000	6				

Receptacles

RIGHT ANGLE PCB RECEPTACLES (male center contact)

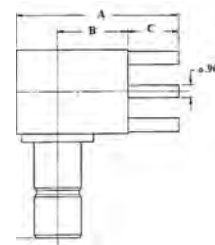
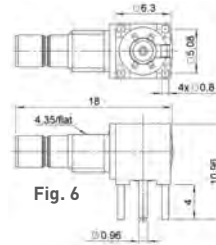
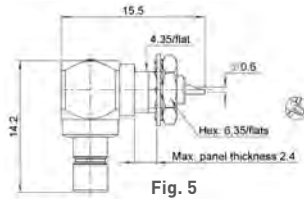
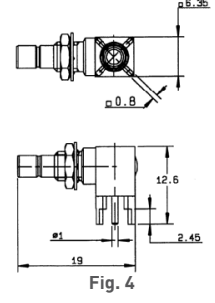
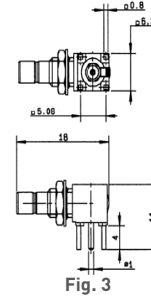
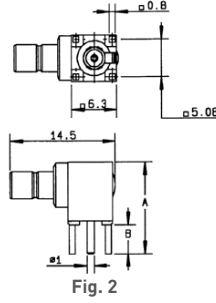
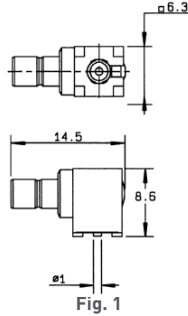

Part number (Gold)	Part number (Nickel)	Fig.	Dimensions mm				Captive center contact	Assembly instructions	Panel drilling	Note
			A	B	C	D				
R114 664 000	n/a	1					yes	M01	Packaging 100p reel	
R114 664 120									SMT / Packaging 500p reel	
R114 665 000		2	12.6	4				P03	Packaging unit	
R114 665 020									Rear mount	
R114 673 020		3								Packaging 100 pieces
R114 673 120										Packaging 200 pieces
R114 670 000	4									
R114 673 823										
2010-1511-000	2010-7511-000	7	10.9	3.8	3.9	12.7		P04		
2010-1511-002	2010-7511-002		12.7	5.5					14.2	

Adapters

IN SERIES ADAPTERS

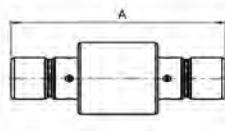

Fig. 1

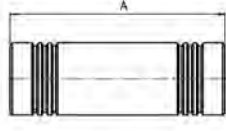

Fig. 2

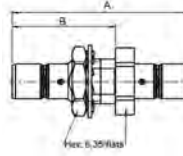

Fig. 3

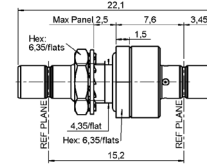

Fig. 4

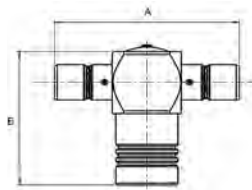

Fig. 5

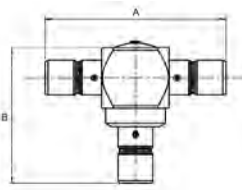

Fig. 6

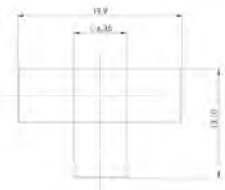

Fig. 7

Part number (Gold)	Part number (Nickel)	Fig.	Dimensions		Captive center contact	Panel drilling	Note	
			A	B				
R114 703 000	n/a	1	19	11	yes	P08	male - male	
R114 704 000		2					female - female	
R114 720 000		3					bulkhead male - male	
R114 753 000		4					hermetically sealed male - male	
R114 780 000		5					tee female / male - male	
R114 781 000		6					tee male / male - male	
5207-1501-000	5207-7501-000	6	12.7					tee male / male - male
5222-1501-000	5222-7501-000	3	17.5	10.7				bulkhead male - male
5213-1501-000	5213-7501-000	1						male - male
5215-1501-000	5215-7501-000	5	19	12.9				tee female / male - male
5216-1501-000	5216-7501-000	2	17.5					female - female
5208-1501-000	5208-7501-000	7						tee female / female - female

SMB LOCK

Introduction

Radiall introduces new **SMB LOCK** plugs with a 2-step connection system:

- 1 **Snap** the plug on the male connector (fig. 1)
- 2 **Lock** the couple by pushing down the coupling nut (fig. 2)

This new range

- Is **intermateable** with the standard **SMB** male connectors
- Benefits from a low intermodulation
- Replaces the standard **SMB** and screw-on connectors in all applications requiring:
 - A fast connection
 - A reliable lock-on connection
 - Long durability
- Possibility to visually control the locking system

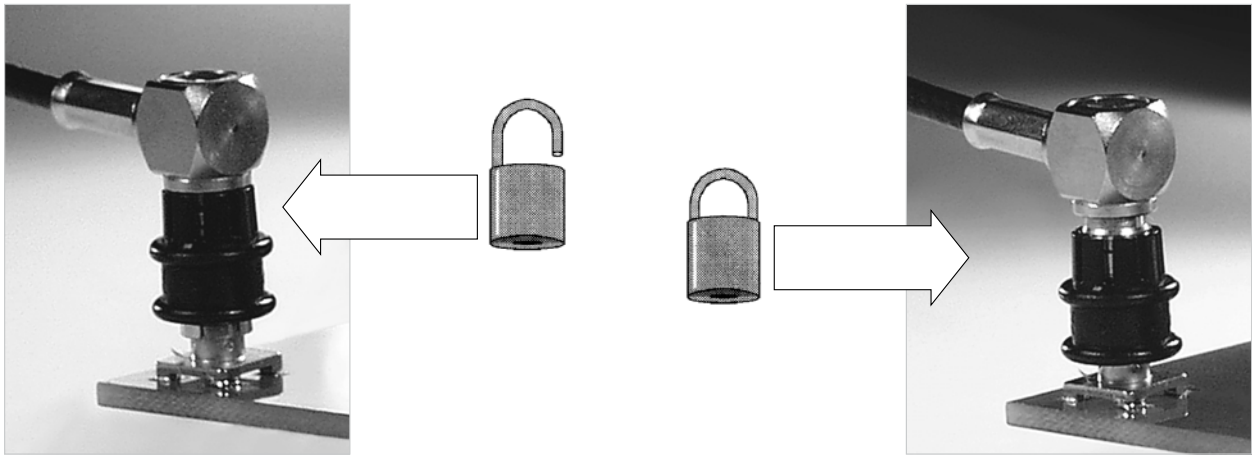
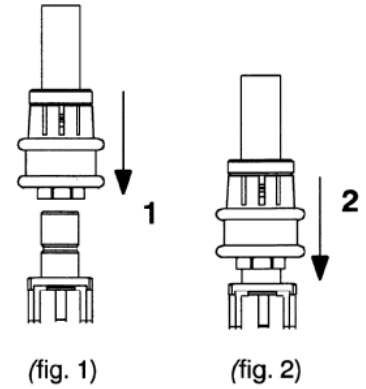

- The connector allows a 360° cable rotation
- Coupling nut

The coupling nut is made with POM (halogen free). Its standard color is black.

Interface

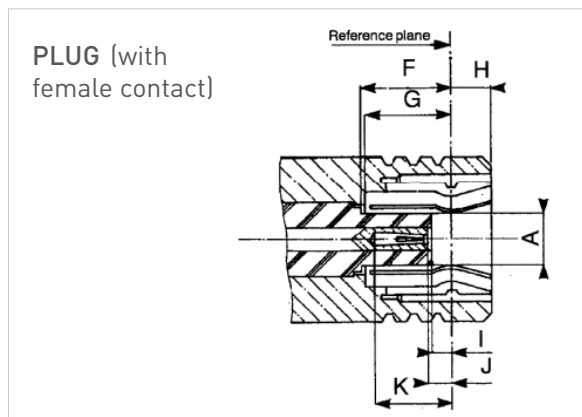

Letter	mm		inch	
	min.	max.	min.	max.
A DIA		2.06		.081
F	3.58		.141	
G	3.58		.141	
H		1.63		.064
I	0.18		.007	
J	0.18	0.94	.007	.037
K	2.97		.117	

Characteristics

Test / Characteristics	Values / Remarks
------------------------	------------------

ELECTRICAL CHARACTERISTICS

Impedance	50Ω		
Operating frequency	DC to 4 GHz		
Typical V.S.W.R.		2 GHz	4 GHz
• Straight models	.085" ∅ 2.6/50	1.15 1.20	1.20 1.25
• Right angle models	.085" ∅ 2.6/50	1.05 1.15	1.15 1.25
RF Insertion loss			
• Straight models	.085" ∅ 2.6/50	0.20vF (GHz) 0.25vF (GHz)	
• Right angle models	.085" ∅ 2.6/50	0.25vF (GHz) 0.50vF (GHz)	
Testing voltage (V RMS)	.085" ∅ 2.6/50	750 1000	
Working voltage (V RMS)	.085" ∅ 2.6/50	335 335	
Insulation resistance (MΩ)	1000		

MECHANICAL CHARACTERISTICS

Life	500 matings min		
Cable retention force	.085" ∅ 2.6/50 ∅ 5/50/S	220 N 110 N 110 N	
Coupling nut retention force	50 N min		
Vibrations	MIL STD 202 F method 240D, condition B		

ENVIRONMENTAL CHARACTERISTICS

Temperature range	-35°C / + 125°C
-------------------	-----------------

MATERIALS AND PLATING

	Material	Plating
Bodies	Brass	BBR
Center contact	Beryllium copper	Gold
Outer contact	Bronze	
Insulator	PTFE	
Coupling nut	POM (halogen free)	

Standard packaging: 100 pieces (For unit packaging, add "W" after the P/N).

Plugs

STRAIGHT PLUG FULL CRIMP TYPE FOR FLEXIBLE CABLES

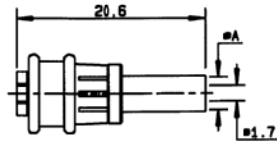
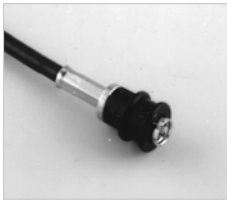

Cable group	Cable group dia	Part number	Dimensions A (mm)	Captive center contact
RG174 / RG188 / RG316	2.6/50/S	R117 082 807	3.25	yes

RIGHT ANGLE PLUG CRIMP TYPE FOR FLEXIBLE CABLES

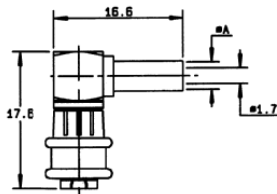

Cable group	Cable group dia	Part number	Dimensions A (mm)	Captive center contact
RG174 / RG188 / RG316	2.6/50/S	R117 186 807	3.25	yes

Receptacles

- Lower mating/unmating force (from 2.5 N to 6N)
- Receptacles intermateable with SMB connectors
- Gold finish

The SMB limited detent connectors have the same electrical characteristics as standard SMB connectors

BULKHEAD PLUG RECEPTACLE (rear fixing)

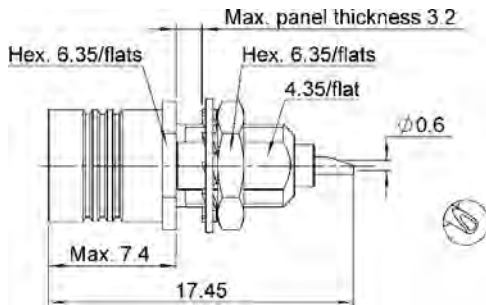

Part number	Panel drilling	Finish
R115 556 000	P08	Gold

SMB limited detent (SMB-A)

STRAIGHT PCB RECEPTACLES (female center contact)

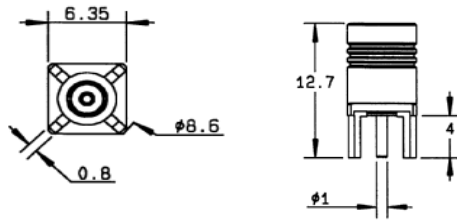
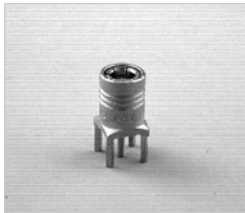

Part number	Captive center contact	Panel drilling	Finish	Packaging
R115 427 000	yes	P05	Gold	Unit

RIGHT ANGLE PCB RECEPTACLE (female center contact)

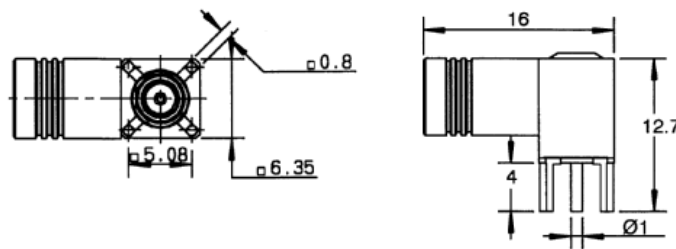

Part number	Captive center contact	Panel drilling	Finish	Packaging
R115 666 000	yes	P04	Gold	Unit

SMB slide-on (SUBGLIS)

Slide on connectors (mating/unmating force: 2.2 N to 4.9 N)

The SMB slide-on connectors are completely intermateable with standard SMB and SMB limited detent connectors and in this regard, they can be used for **test applications**. The SMB slide-on connectors have the same electrical characteristics as standard SMB connectors.

PCB RECEPTACLES

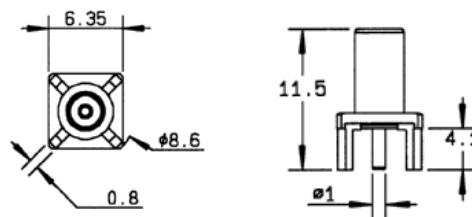
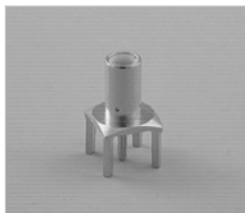

Part number	Captive center contact	Panel drilling	Finish	Packaging	Note
R116 426 000	yes	P03	Gold	Unit	Male center contact

Panel drilling

P01

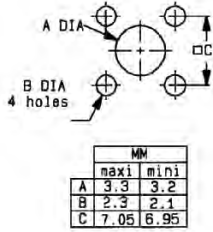

P02

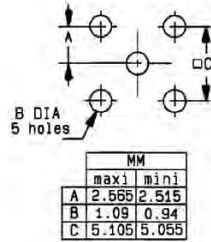

P03

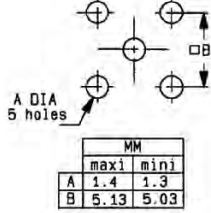

P04

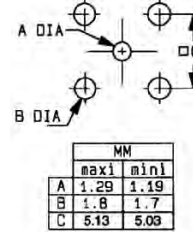

P05

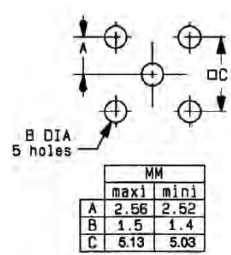

P06

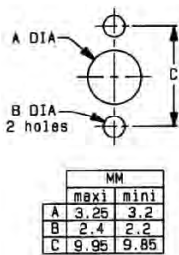

P07

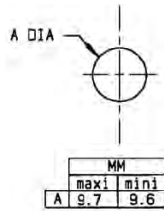

P08



P09

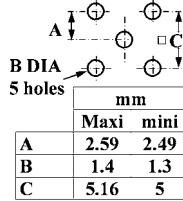

P10

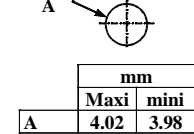

Assembly instructions

M01

Part number
R114 423 000

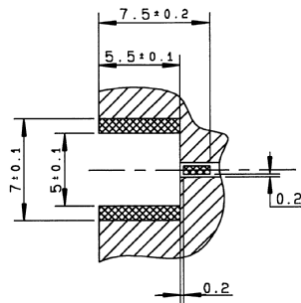

Part number
R114 424 000
R114 424 100
R114 664 000
R114 664 120

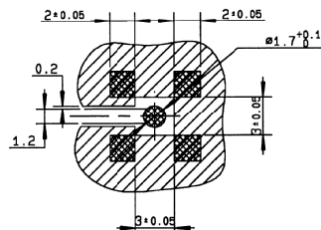

Video shadow:

Part number
R113 423 000

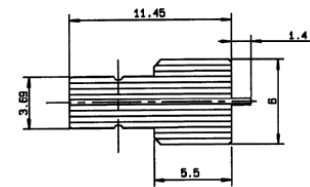

Part number
R114 424 000
R114 424 100

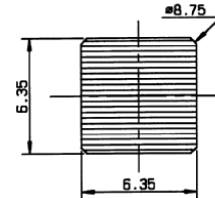

Part number
R114 664 000
R114 664 120

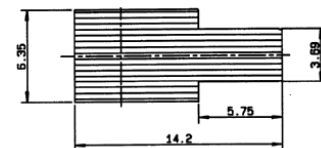

Vaccum nozzle dimensions:

Part number
R114 424 000

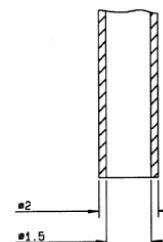

Introduction



50Ω	DC - 10 GHz
-----	-------------

GENERAL

- Subminiature coaxial connectors
- Screw-on coupling
- Plugs have female contacts
- Jacks have male contacts
- Low weight
- Reduced outline dimensions

APPLICABLE STANDARDS

- MIL-C-39012

APPLICATIONS

- Civil and military telecommunications
- Aeronautics
- Missiles
- Edge mounting applications

Interface

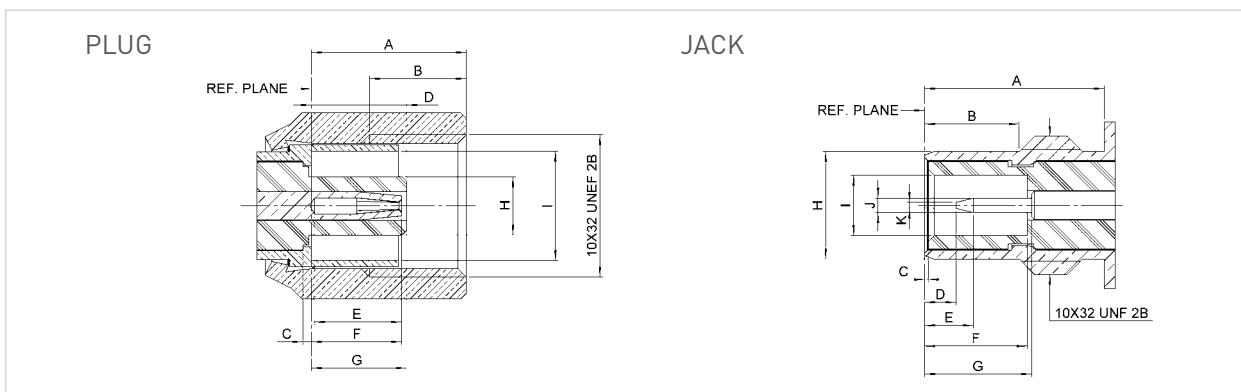

Letter	mm		inch	
	min.	max.	min.	max.
A	5.14	5.55	.202	.219
B	3.20	4.20	.126	.165
C	0.25	0.35	.010	.014
D	2.95	3.00	.116	.118
E	2.80	3.20	.110	.126
F	2.80	3.40	.110	.134
G	3.15	3.40	.124	.134
H	2.00	2.05	.079	.081
I	3.75	3.80	.148	.150

Letter	mm		inch	
	min.	max.	min.	max.
A	6.00	6.20	.236	.244
B	3.15	3.35	.124	.132
C	0.05	0.20	.002	.008
D	0.65	1.50	.026	.059
E	1.30	2.05	.051	.081
F	3.40	3.71	.134	.146
G	3.40	3.95	.134	.156
H	3.65	3.69	.144	.145
I	2.08	2.13	.082	.084
J	0.48	0.52	.019	.020
K	--	0.20	--	.008

Characteristics

Test / Characteristics	MIL-C-39012 paragraph	Values / Remarks
------------------------	-----------------------	------------------

ELECTRICAL CHARACTERISTICS

Impedance		50Ω
Frequency range		DC - 10 GHz
V.S.W.R. (typ.) • Straight • Right angle	cable 3-14	2/50 1.25 + 0.04 F (GHz) 1.40 + 0.06 F (GHz) 2.6/50 1.20 + 0.04 F (GHz) 1.30 + 0.04 F (GHz)
Insertion loss • Straight • Right angle	3-27	0.25 dB max. at 4 GHz 0.5 dB max. at 4 GHz
RF leakage	3-26	-60 dB min between 2 and 3 GHz
Insulation resistance	3-11	1000 MΩ min
Contact resistance • Center contact (mΩ) • Outer contact (mΩ)	3-16	Initial 6 1 After environment 8 1.5
Voltage rating (volts RMS) • At sea level • At 70000 ft (21000 m)	cable	2/50 250 V rms 60 V rms 2.6/50 335 V rms 85 V rms
Dielectric withstanding voltage • At sea level • At 70000 ft (21000 m)	cable 3-17	2/50 750 V rms 185 V rms 2.6/50 1000 V rms 250 V rms
RF high potential withstanding voltage (Frequency 5 MHz) • At sea level	cable 3-23	2/50 500 V rms 2.6/50 700 V rms

MECHANICAL CHARACTERISTICS

Durability	3-15	500 matings
Force to engage and disengage	3-5-1	torque: 16 inch-ounces max - 11.3 Ncm
Mating torque		35 to 50 inch-ounces - 25 to 35 Ncm
Coupling nut proof torque		100 inch-ounces - 71 Ncm
Coupling nut retention force	3-25	35 lbs min - 156 N min
Cabling retention force	cable 3-24	2/50 13 lbs - 58 N 2.6/50 25 lbs - 110 N
Contact captivation		Axial force: 4 lbs - 18 N torque: not applicable

ENVIRONMENTAL CHARACTERISTICS

Operating temperature range • Standard models and hermetic • Models for semi-rigid cables		-65°C / + 165°C -65°C / +105°C
Temperature cycling		MIL-STD-202, method 102, condition C
Thermal shock	3-20	MIL-STD-202, method 107, condition B
High temperature test		MIL-STD-202, method 108
Corrosion (salt spray)	3-13	MIL-STD-202, method 101, condition B, 5%
Vibration	3-18	MIL-STD-202, method 204, condition D, 20g
Shock	3-19	MIL-STD-202, method 213, condition C, 100g
Moisture resistance	3-21	not applicable
Barometric pressure	3-22	MIL-STD-202, method 105, condition C
Hermetic test		Down to 10 ⁻⁶ mm Hg (Torr) Leak rate <1 x 10 ⁻⁶ atm/cm ³ /sec

MATERIALS AND PLATING

	Material	Plating
Bodies and male contacts	Brass, half hard per QQ-B-626	Gold to satisfy the corrosion requirements (bodies)
Female contacts and interfaces	Beryllium copper per QQ-C-530	Gold (Center contact)
Ferrules	Brass	
Insulators	PTFE teflon	
Gaskets	Silicone rubber	

All dimensions are given in mm.

Plugs and jack

STRAIGHT PLUGS

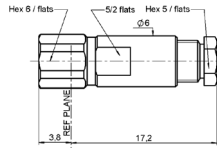

Fig. 1

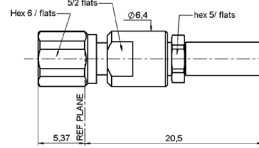

Fig. 2

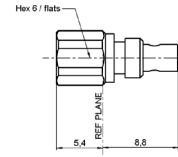

Fig. 3

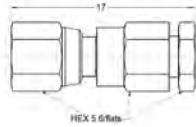

Fig. 4

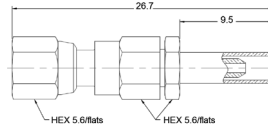

Fig. 5

Cable group	Cable group dia	Part number (Gold)	Part number (Nickel)	Fig.	Note
RG178 / RG196	2/50/S	R112 003 000	n/a	1	Clamp type
RG174 / RG316 / RG179	2.6/50+75/S	R112 005 000			
		R112 075 000			
RG405	.085"	R112 053 000		3	Solder type
RG178 / RG196	2/50/S	1002-1571-002	1002-7571-002	5	Crimp type
		1002-1551-002	1002-7551-002	4	Clamp type
RD178	2/50/D	1002-1551-005	1002-7551-005	5	Crimp type
		1002-1571-005	1002-7571-005	5	Crimp type
RG174 / RG316 / RG179	2.6/50/S	1002-1551-003	1002-7551-003	4	Clamp type
		1002-1571-003	1002-7571-003	5	Crimp type
RD316	2.6/50/D	1002-1551-019	1002-7551-019	4	Clamp type
		1002-1571-019	1002-7571-019	5	Crimp type
RG405	.085"	1002-1541-010	1002-7541-010	4	Solder clamp
RG402	.141"	1002-1541-009	1002-7541-009		

RIGHT ANGLE PLUGS

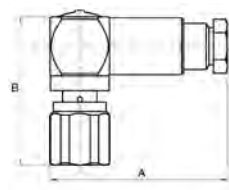

Fig. 1

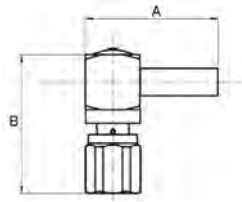

Fig. 2

Cable group	Cable group dia	Part number (Gold)	Part number (Nickel)	Fig.	Dimensions mm		Note
					A dia	B dia	
RG174 / RG316 / RG179	2.6/50+75/S	R112 165 000	n/a	1	19	15.9	Crimp type
RG178 / RG196	2/50	R112 183 000			16	15.5	
RG174 / RG316 / RG179	2.6/50+75/S	R112 186 000			2	15.3	
RG178 / RG196	2/50/S	1005-1551-002	1005-7551-002	1	14.9	13.9	Clamp type
		1105-1521-002	1105-7521-002	2	16		Crimp type
RD178	2/50/D	1005-1551-005	1005-7551-005	1	14.9		Clamp type
		1105-1521-005	1105-7521-005	2	16		Crimp type
RG174 / RG316 / RG179	2.6/50/S	1005-1551-003	1005-7551-003	1	14.9		Clamp type
		1105-1521-003	1105-7521-003	2	16		Crimp type
RD316	2.6/50/D	1005-1551-019	1005-7551-019	1	14.9		Clamp type
		1105-1521-019	1105-7521-019	2	16		Crimp type
RG405	.085"	1005-1541-010	1005-7541-010	1	14.9		Solder clamp
RG402	.141"	1005-1541-009	1005-7541-009				

Jacks and receptacles

STRAIGHT JACK

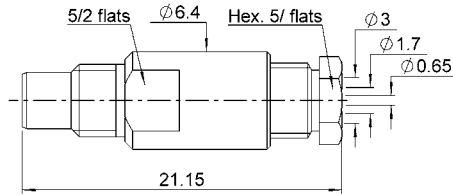

Fig. 1

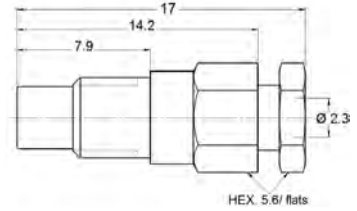

Fig. 2

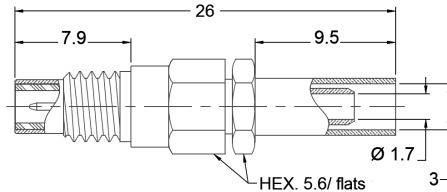

Fig. 3

Cable group	Cable group dia	Part number (Gold)	Part number (Nickel)	Note
RG174 / RG316 / RG179	2.6/50+75/S	R112 205 000		Clamp type
RG178 / RG196	2/50/S	1001-1551-002	1001-7551-002	
RD178	2/50/D	1001-1551-005	1001-7551-005	Clamp type
		1001-1571-005	1001-7571-005	Crimp type
RG174 / RG316 / RG179	2.6/50/S	1001-1551-003	1001-7551-003	Clamp type
		1001-1571-003	1001-7571-003	Crimp type
RD316	2.6/50/D	1001-1551-019	1001-7551-019	Clamp type
		1001-1571-019	1001-7571-019	Crimp type
RG405	.085"	1001-1571-010	1001-7571-010	Solder clamp
RG402	.141"	1001-1571-009	1001-7571-009	

BULKHEAD STRAIGHT AND RIGHT ANGLE JACKS

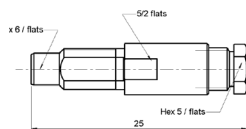

Fig. 1

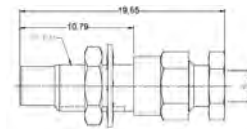

Fig. 2

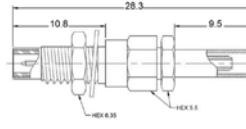

Fig. 3

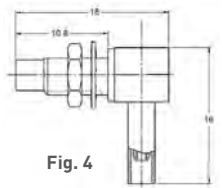

Fig. 4

Cable group	Cable group dia	Part number (Gold)	Part number (Nickel)	Fig.	Panel drilling	Note
RG178 / RG196	2/50/S	R112 303 000		1	P03	
RG174 / RG316 / RG179	2.6/50+75/S	R112 305 000				
RG178 / RG196	2/50/S	1003-1551-002	1003-7551-002	2		Clamp type
		1003-1571-002	1003-7571-002	3		Crimp type
		1006-1551-002	1006-7551-002	4		Clamp type
		1106-1521-002	1106-7521-002			Crimp type
RD178	2/50/D	1003-1551-005	1003-7551-005	2		Clamp type
		1003-1571-005	1003-7571-005	3		Crimp type
		1006-1551-005	1006-7551-005	4		Clamp type
		1106-1521-005	1106-7521-005			Crimp type
RG174 / RG316 / RG179	2.6/50/S	1003-1551-003	1003-7551-003	2	Clamp type	
		1003-1571-003	1003-7571-003	3	Crimp type	
		1006-1551-003	1006-7551-003	4	Clamp type	
		1106-1521-003	1106-7521-003		Crimp type	

Jacks and receptacles

BULKHEAD STRAIGHT AND RIGHT ANGLE JACKS (CONTINUED)

Cable group	Cable group dia	Part number (Gold)	Part number (Nickel)	Fig.	Panel drilling	Note
RD316	2.6/50/D	1003-1551-019	1003-7551-019	2	P03	Clamp type
		1003-1571-019	1003-7571-019	3		Crimp type
		1006-1551-019	1006-7551-019	4		Clamp type
		1106-1521-019	1106-7521-019			Crimp type
RG405	.085"	1003-1541-010	1003-7541-010	2		Solder clamp
		1006-1541-010	1006-7541-010	4		
RG402	.141"	1003-1541-009	1003-7541-009	2		
		1006-1541-009	1006-7541-009	4		

SQUARE FLANGE RECEPTACLES

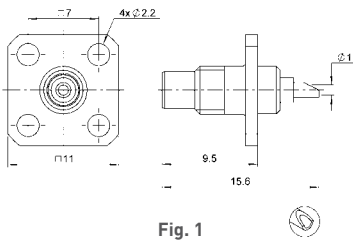

Fig. 1

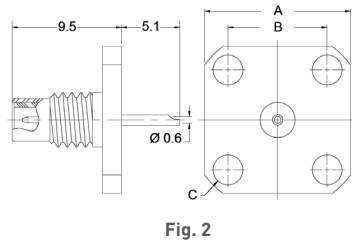

Fig. 2

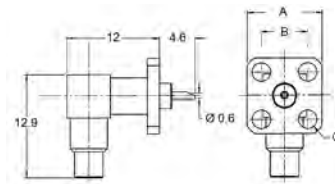

Fig. 3

Part number (Gold)	Part number (Nickel)	Fig.	Dimensions (mm)			Panel drilling
			A	B	C	
R112 403 000	n/a	1				P01
1484-1511-000	1484-7511-000	2	9.5	5.9	2.4	
1486-1511-000	1486-7511-000		12.7	8.6	2.6	
1490-1511-000	1490-7511-000	3				
1488-1511-000	1488-7511-000		9.5	5.9	2.4	

BULKHEAD RECEPTACLES WITH SOLDER POT CONTACT

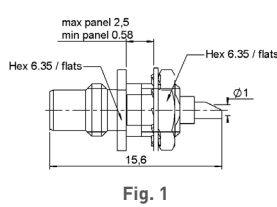

Fig. 1

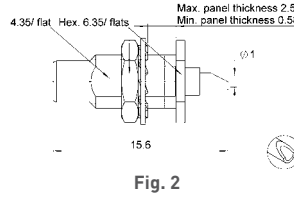

Fig. 2

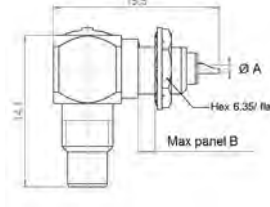

Fig. 3

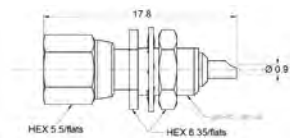

Fig. 4

Part number (Gold)	Part number (Nickel)	Fig.	Dimensions (mm)		Panel drilling	Note
			A	B		
R112 553 000	n/a	1			P03	Front mount
R112 554 000		2				Rear mount
R112 670 000		3	0.6	1.55		Front mount
1004-1511-000	1004-7511-000	2				Rear mount
1019-1511-000	1019-7511-000	1				Front mount
1012-1511-000	1012-7511-000	3	0.9	2.4		
1017 1511-000	1017 7511-000	4				

Receptacles and adapters

PCB RECEPTACLES

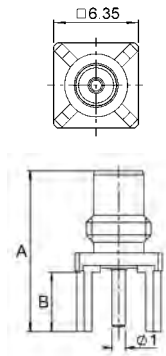

Fig. 1

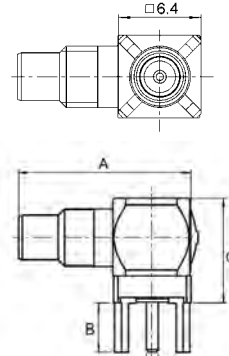

Fig. 2

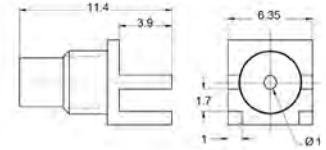

Fig. 3

Part number (Gold)	Part number (Nickel)	Fig.	Dimensions (mm)			Panel drilling	Note	
			A	B	C			
R112 426 000	n/a	1	11.8	4.4	12.7	P02	Standoff legs	
R112 665 000		2	14.2					
1009-1511-000	1009-7511-000	1	11.4	4	7	P04	No standoff	
1010-1511-000	1010-7511-000	2	14					8.8
1010-1511-001	1010-7511-001		1		16.3	7		P04 + P03
1109-1511-000	1109-7511-000	2	18					
1110-1511-000	1110-7511-000	2	18					
1009-1511-005	1009-7511-005	3				P04	End launch type	

IN SERIES ADAPTERS

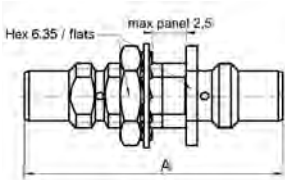

Fig. 1

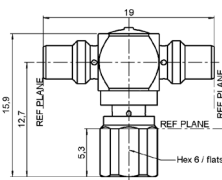
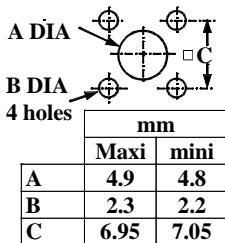

Fig. 2

Part number (Gold)	Fig.	Dimensions A (mm)	Panel drilling	Note
R112 720 000	1	19	P03	male - male bulkhead
R112 780 000	2			tee male - male / female
5822-1501-000	1	17.5	P03	female - female

Panel drilling

P01



P02

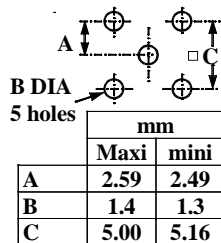

P03

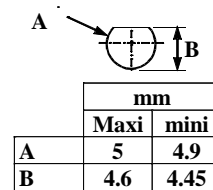

P04

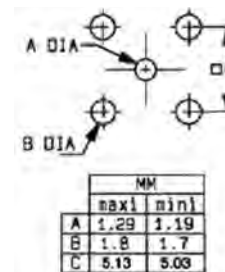

SECTION 7



SMA / SMA-COM / BMA
R125 / R124 / R128



Contents

BMA

Introduction 7-4
 Characteristics 7-5
 Plugs 7-6
 Jacks 7-7 to 7-8
 Receptacles 7-8 to 7-11
 Panel drilling 7-11 to 7-12

SMA

Introduction 7-13 to 7-14
 Interface 7-15
 Characteristics 7-16 to 7-17
 Straight plugs 7-17 to 7-18
 Right angle plugs 7-19 to 7-21
 Straight jacks 7-22
 Bulkhead jacks 7-23 to 7-25
 Receptacles 7-26 to 7-30
 Receptacles for microstrip 7-31 to 7-32
 Hermetic receptacles with separate glass bead 7-33
 Hermetic receptacles with integrated glass bead 7-34
 Hermetic receptacles without glass bead 7-35
 Adapters 7-35 to 7-36
 Accessories 7-36
 Glass beads 7-37
 Accessories for hermetic microstrip receptacles 7-38
 Panel drilling 7-38 to 7-40
 Tooling for hermetic receptacles 7-40
 Field replaceable hermetic microstrip receptacle information 7-41 to 7-42

SMA-COM

Introduction 7-43 to 7-44
 Interface 7-45
 Characteristics 7-46
 Plugs 7-47 to 7-48
 Jacks 7-48 to 7-49
 Receptacles and switches 7-50 to 7-52
 Panel drilling 7-52
 Assembly instructions 7-53 to 7-54

Introduction

	BMA
50Ω	DC - 22 GHz

GENERAL

- Blind mate connector
- Slide-on coupling
- High frequency
- Float mount design allows large axial and radial misalignment

APPLICABLE STANDARDS

- MIL-STD-348 Fig. 321
- CEI 1169-33
- Compatible with OSP series

APPLICATIONS

- Airborne and ground radars
- Active electronically scanned array antennas
- Rack and panel telecommunication equipments
- Military microwave modules



Radiall's BMA series has been designed for applications where reliability, durability and performances at high frequency are essential. BMA is a blind mate connector widely used to interconnect microwave modules with multiple coaxial ports. Float mount connectors are recommended for multiple interconnects. Contact Radiall for mounting tolerances.

WIDE RANGE

The BMA product range consists of cable connectors for flexible cables, semi-rigid cables and SHF cables, floating bulkhead or flange mount, PCB receptacles, press mount receptacles, screw-on receptacles, hermetic receptacles, coaxial contacts for rectangular or circular multipin connectors and adapters.

NEW SPRING FINGERS OUTER CONTACT

In 2007, a new outer contact was designed and introduced on all BMA female connectors. The new spring fingers outer contact provides improved performances and stability at high frequency up to 22 GHz. Old BMA female part numbers are obsolete and have been replaced with new part numbers which are listed in this catalog.

Characteristics

Test / Characteristics	Values / Remarks
------------------------	------------------

ELECTRICAL CHARACTERISTICS

Impedance	50Ω	
Frequency range	DC - 22 GHz	
V.S.W.R.	.085"/ RG405 semi-rigid cable: 1.05 + 0.01 F (GHz)	
Insertion loss (typ.) dB	0.03 √ F (GHz)	
RF leakage (min.) dB	-90 + F (GHz) for gold and BBR connector body -80 + F (GHz) for passivated connector body	
Insulation resistance	≥ 5000 MΩ	
Contact resistance	Center contact : 5 mΩ max. / Outer contact : 2.5 mΩ max.	
Voltage in V. RMS • At sea level • At 70000 ft	Dielectric withstanding voltage ≥ 1000 V. 200 V.	Working voltage ≤ 335 V. 85 V.

MECHANICAL CHARACTERISTICS

Durability	>1000 cycles	
Force to engage	13.6 N (3 lbf) max.	
Force to disengage	0.56 N (0.13 lbf) min.	
Cable retention force	.085"/ RG405 cable	.141"/ RG402 cable
	> 136 N (30 lbf)	> 272 N (61 lbf)
Center contact retention force	27 N (6 lbf) min.	
Misalignment • Radial misalignment • Axial misalignment	Fixed mount ± 0.1mm (.004 in) 0.38mm (.015 in) max.	Float mount ± 0.51mm (.020 in) 1.52mm (.060 in) min.

ENVIRONMENTAL CHARACTERISTICS

Temperature range • Standard models • Semi-rigid cables	-65°C / + 165°C -65°C / +105°C
Thermal cycling	MIL-STD-202, Method 107, Condition B, -65°C / +125°C
Vibration	MIL-STD-202, Method 204, Condition D, 20 g
Shock	MIL-STD-202, Method 213, Condition A, 50 g
Bumps	CECC 22000, Paragraph 4.6.2, 4000 bumps per axis
Moisture resistance	MIL-STD-202, Method 106
Corrosion	MIL-STD-202, Method 101, Condition A, 96H
Degree of protection	IP54 (male connector with O-ring)

MATERIALS AND PLATING

	Material	Plating
Body/Nut	Stainless steel (standard BMA) Brass (commercial BMA)	Gold or Passivated BBR
Center contacts	Brass (male) Beryllium copper (female)	Gold over Nickel or NPGR
Outer contact	Beryllium copper	NPGR
Gaskets	Silicon rubber	
Insulators	PTFE	

Plugs and contacts

STRAIGHT PLUGS, SOLDER TYPE FOR SEMI-RIGID CABLES

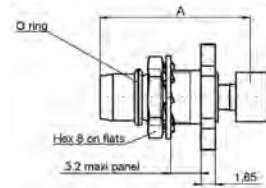

Fig. 1

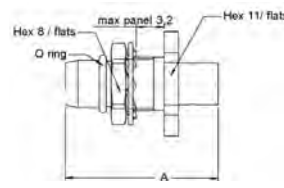

Fig. 2

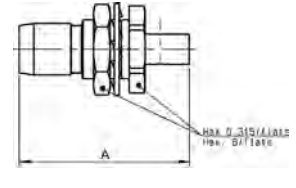

Fig. 3

Cable group	Cable group dia.	Part number	Fig.	Dimension A (mm)	Panel drilling	Body	Finish	Captive center contact	Note
RG405	.085"	R128 052 901	1	17	P01	Stainless steel	Passivated	yes (epoxy)	Crimp type, easy installation
		R128 052 000	2				Gold		
		R128 052 827	3				BBR	yes (4 indents)	No O-ring
RG402	.141"	R128 055 000	2	17.6	P01	Stainless steel	Gold	yes (epoxy)	
		R128 055 827	3				BBR	yes (4 indents)	No O-ring

STRAIGHT BULKHEAD PLUGS CRIMP TYPE FOR FLEXIBLE CABLE

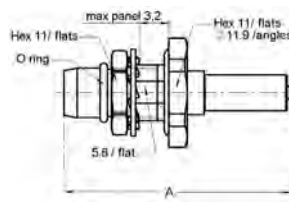

Fig. 1

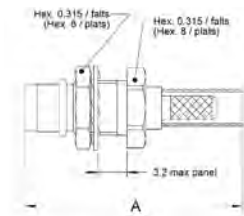

Fig. 2

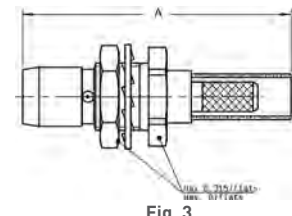

Fig. 3

Cable group	Cable group dia.	Part number	Fig.	Dimension A (mm)	Panel drilling	Body & finish	Captive center contact	Note
RG174 / RG316	2.6/50/S	R128 081 001	1	24.6	P02	Stainless steel passivated	yes (barb)	Waterproof
		R128 083 001	2				yes (epoxy)	
		R128 083 827	3					
RD316	2.6/50/D	R128 084 827	3	24.2	P01	Brass BBR	yes (4 indents)	No O-ring
RG142 / RG223 / RG400	5/50D	R128 088 827						

STRAIGHT CONTACTS SIZE 8 FOR MIL-STD-38999 CONNECTORS SOLDER TYPE

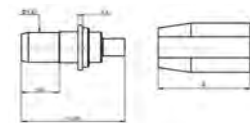

Fig. 1

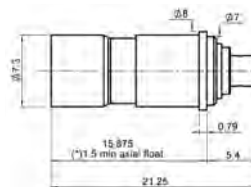

Fig. 2

Cable group	Cable group dia.	Part number	Body & finish	Fig.	Captive center contact	Gender
RG405	.085"	R128 053 000	Stainless steel Gold plated	1	yes (epoxy)	Pin
		R128 294 710		2		Socket
RG402	.141"	R128 056 000		1		Pin
		R128 296 710		2		Socket

Jacks

STRAIGHT FLOATING JACKS SOLDER TYPE FOR SEMI-RIGID CABLE

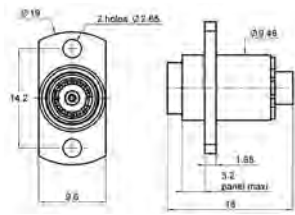

Fig. 1

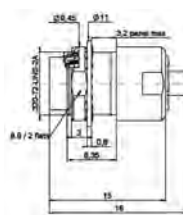

Fig. 2

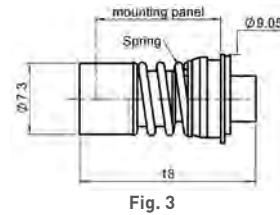

Fig. 3

Cable group	Cable group dia.	Part number	Fig.	Panel drilling	Body & finish	Captive center contact	Panel mount
RG405	.085"	R128 292 700	1	P03	Stainless steel gold plated	yes (epoxy)	2-hole flange
		R128 292 727			Brass BBR	yes (4 indents)	Bulkhead
		R128 293 702	2	P18			
RG402	.141"	R128 294 700	3	P04	Stainless steel gold plated	yes (epoxy)	Snap-in
		R128 296 700	1	P03	Brass BBR	yes (4 indents)	2-hole flange
		R128 295 700					
		R128 295 727					

STRAIGHT FLOATING JACKS CRIMP TYPE FOR FLEXIBLE CABLE

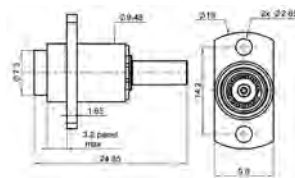

Fig. 1

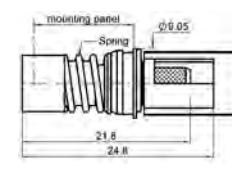

Fig. 2

Cable group	Cable group dia.	Part number	Fig.	Panel drilling	Body & finish	Captive center contact	Panel mount
RG174 / RG316	2.6/50S	R128 263 707	1	P03	Brass BBR	yes (4 indents)	2-hole flange
RD316	2.6/50D	R128 264 707					
RG142 / RG223 / RG400	5/50/D	R128 268 717					
RG174 / RG316	2.6/50/S	R128 263 711					
RG142 / RG223 / RG400	5/50/D	R128 268 701					
RG174 / RG316	2.6/50/S	R128 233 701	2	P04	Stainless steel passivated	yes (epoxy)	Snap-in
RG142 / RG223 / RG400	5/50/D	R128 238 701					

Receptacles

PCB FEMALE RECEPTACLES

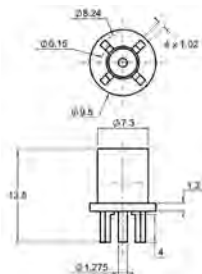

Fig. 1

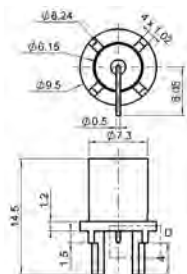

Fig. 2

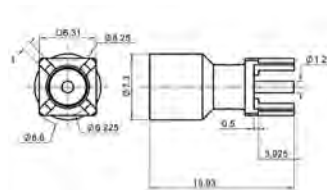

Fig. 3

Part number	Fig.	Panel drilling	Body & finish	Captive center contact
R128 426 700	3	P09	Brass gold plated	yes (4 indents)
R128 426 710	1	P10	Stainless steel gold plated	yes (epoxy)
R128 427 700	2	P11		

NARROW AND SQUARE FLANGE EXTENDED DIELECTRIC MALE RECEPTACLES

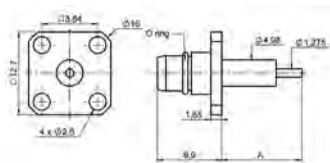

Fig. 1

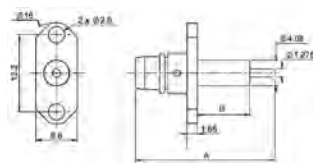

Fig. 2

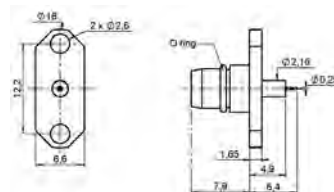

Fig. 3

Part number	Fig.	Dimension		Panel drilling	Body & finish	Captive center contact	Panel mount	Note
		A (mm)	B (mm)					
R128 444 201	1	12.4	8.4	P06	Stainless steel passivated	yes (epoxy)	4 hole flange	No O-ring
R128 444 307		10.7	5.6		Brass BBR	yes (4 indents)		
R128 474 201	2	22.3	8.4	P05	Stainless steel passivated	yes (epoxy)	2 hole flange	
R128 474 211		17.4	5		Brass BBR	yes (4 indents)		
R128 474 847		16.4	8.4					
R128 474 857	3	22.3	8.4	P13	Stainless steel passivated	yes (epoxy)		
R128 484 001								

NARROW AND SQUARE FLANGE EXTENDED DIELECTRIC FEMALE RECEPTACLES

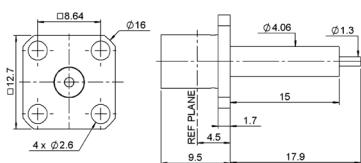

Fig. 1

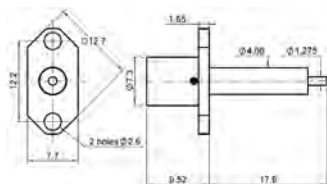
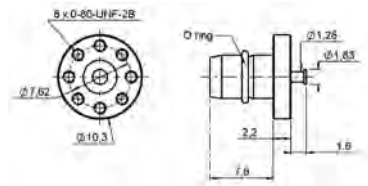

Fig. 2

Part number	Fig.	Panel drilling	Body & finish	Captive center contact	Note
R128 414 701	1	P06	Stainless steel passivated	yes (epoxy)	Square flange
R128 464 701	2	P12			2 hole flange

Receptacles

SPECIAL FLANGE MALE RECEPTACLE



Part number	Panel drilling	Body & finish	Captive center contact	Note
R128 545 011	P16	Stainless steel passivated	no	Turret contact type

NARROW FLANGE REPLACEABLE MALE RECEPTACLES

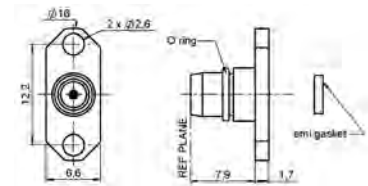

Part number	Panel drilling	Body & finish	Captive center contact	Accept pin diameter	Note
R128 490 021	P13	Stainless steel passivated	yes (epoxy)	0.93 mm	No EMI gasket
R128 481 001				0.3 mm	EMI gasket
R128 481 011				0.5 mm	

SCREW-ON AND PRESS-FIT MALE RECEPTACLES

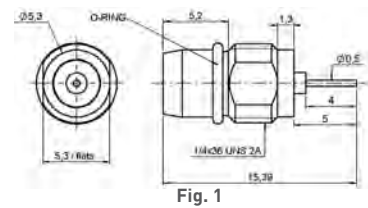

Fig. 1

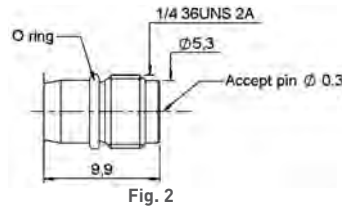

Fig. 2

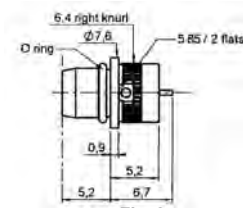

Fig. 3

Part number	Fig.	Panel drilling	Body & finish	Captive center contact	Panel mount	Note
R128 555 101	1	P14	Stainless steel passivated	yes (epoxy)	Screw-on	Cylindrical
R128 556 001	2	P15				Socket
R128 595 001	3	P08			Press-fit	Cylindrical

SCREW-ON HERMETIC RECEPTACLES WITH EMI GASKET (with integrated glass bead)

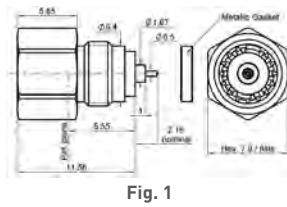

Fig. 1

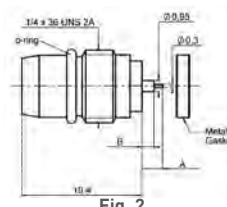

Fig. 2

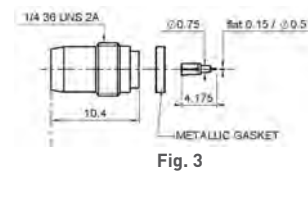
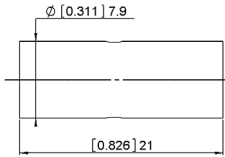

Fig. 3

Part number	Fig.	Dimension		Body & finish	Captive center contact	Note
		A (mm)	B (mm)			
R128 609 701	1			Stainless steel passivated	yes	Female
R128 639 000	2	1.8	1			Stainless steel gold plated
R128 639 001		3				
R128 639 020		1.8	1.05			
R128 639 100	3			Stainless steel passivated		Male, with auxiliary contact, no O-ring
R128 639 071						

Receptacles

FEMALE-FEMALE STRAIGHT ADAPTER



Part number	Body & finish	Captive center contact
R128 705 711	Stainless steel passivated	yes (epoxy)

Panel drilling

P01

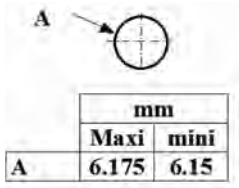

P02

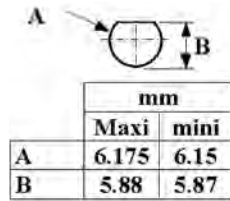

P03

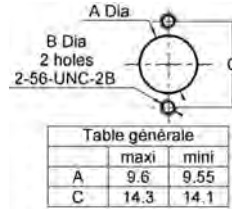

P04

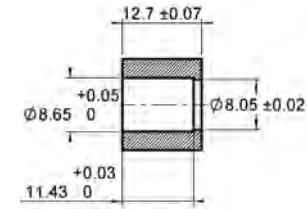

P05

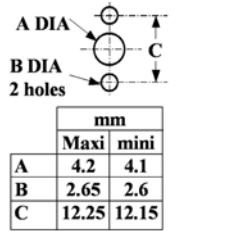

P06

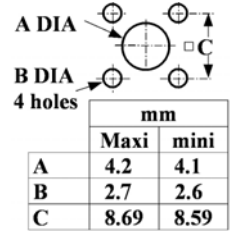

P07

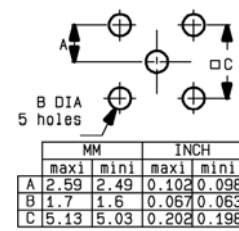

P08

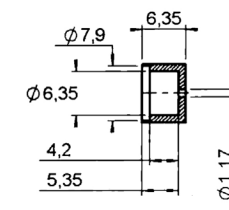

P09

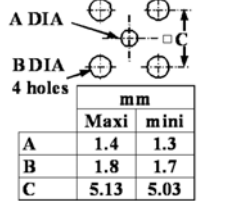

P10

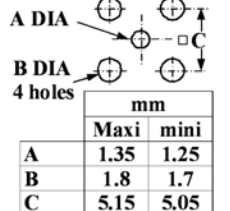

P011

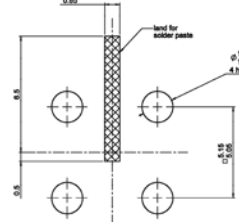

P12

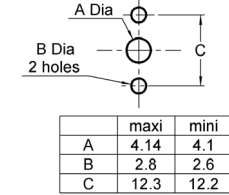

P13

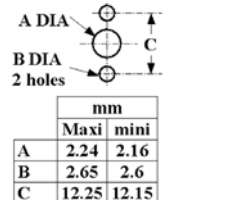

P14



P15

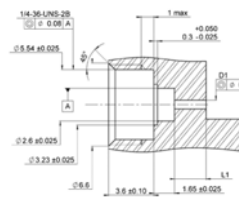

P16

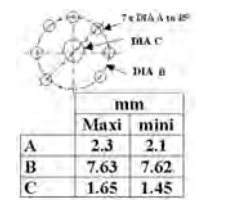

Panel drilling

HERMETIC GLASS BEAD RECEPTACLES

P17

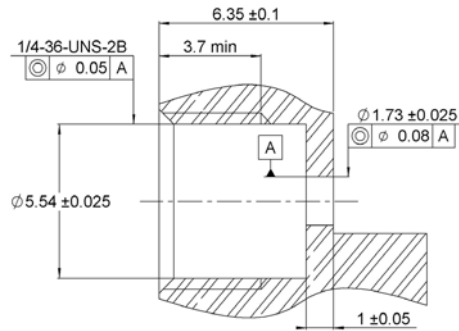

INSTALLATION TOOLS FOR HERMETIC RECEPTACLES

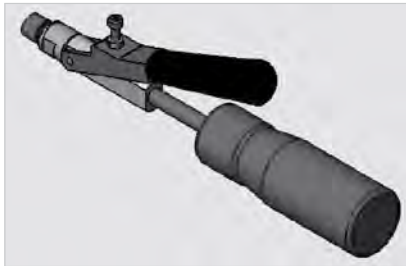

Part number	Body & finish	Captive center contact
R282 340 000	280 N.cm	Tool for male receptacles R128 639 xxx

Introduction

Radiall stainless steel SMA connectors have been designed for applications where reliability, durability, robustness and high frequency are critical.

• WIDE RANGE

The stainless steel SMA range offers cable connectors for both flexible or semi-rigid cables, panel and PCB mount receptacles, press mount, microstrip, universal, through hole pins and end launch connectors. In series adapters and between series adapters including PUSH-ON interface are also available.

All Radiall stainless steel SMA connectors can be mated with Radiall commercial (brass) SMA connectors.

• CONVENIENT 3-PIECE DESIGN ON MOST CONNECTORS FOR FLEXIBLE CABLES

- For straight models: single piece body + center contact + outer ferrule
- For right angle models: single piece body + cap + outer ferrule

• FAST AND RELIABLE CABLE ATTACHMENT

The cable connectors can be either fully crimped or soldered/crimped, offering full flexibility for high volume production with standard manual or pneumatic tooling: fast and reliable.

- The center contact can be either crimped or soldered
- The outer contact is attached to the cable by crimping a ferrule

• SIMPLE SNAP-IN CENTER CONTACT CAPTIVATION (FOR FULL CRIMP MODELS)

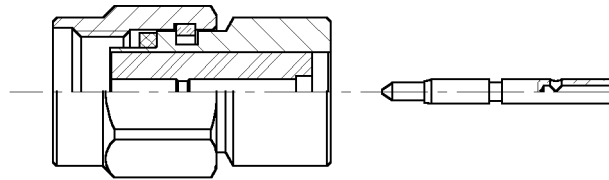

The relative position of the center contact into the interface is mechanically guaranteed by the snapping of the insulator inner shoulder into the groove of the center contact.

This design facilitates the captivation operation in contrast of other designs, requiring 2 insulators to provide contact retention.

• EXTENDED FREQUENCY SMA DC-27 GHz

Radiall offers an extended frequency SMA range allowing coaxial system operation up to 27 GHz. This series mates with the standard SMA series and maintains the same mechanical characteristics (part numbers ending with 700, 701 or 702).

• SOLDERLESS ATTACHMENT TO SEMI-RIGID CABLE

Radiall's SMA crimp connector series offers an exciting alternative for assembling SMA connectors to semi-rigid cable. The main advantages of these connectors are: time savings, repeatability and performance.



Introduction



• **SMA HERMETIC**

Hermetic connectors are required to maintain a pressurized or vacuum environment inside a micro-electronic package. Radiall offers 3 types of hermetic connectors:

1. Field replaceable hermetic receptacles with separate glass bead

(leakage rate below 10^{-8} atm.cm³/sec)

The hermeticity level is guaranteed by the glass bead soldered into the package. A large selection of glass beads is available from dia 0.3 to 0.5 mm. They are usually ordered separately from the receptacle. The receptacle can be removed (field replaceable) from the package for maintenance without any risk of leakage. The field replaceable receptacle is recommended when a high number of matings is required.

2. Hermetic receptacles with integrated glass bead

(leakage rate below 10^{-8} atm.cm³/sec)

The glass bead is already in place inside the receptacle, hermeticity is guaranteed by a solder joint between the receptacle and the package or with a metallic compression gasket. Screw-on receptacle with metallic compression gasket offers superior climatic resistance: -65°C +200°C.

3. Hermetic receptacles without glass bead

(leakage rate below 10^{-6} atm/cm³/sec)

A good hermeticity level is obtained with a metallic gasket at a cost advantage compared to glass beads.



50Ω	DC - 18 GHz
	DC - 27 GHz

GENERAL

- Sub-miniature coaxial connectors
- Screw-on coupling
- High RF performance
- 2 plating options:
 - passivated stainless steel
 - gold plated
- Wide hermetically sealed range
- Space qualified range of products
- SMA extended frequency 27 GHz

APPLICABLE STANDARDS

- MIL-C-39012
- EC 169-1
- CECC 22110
- CECC 22111 - 801 to 808
- BS 9210 N006

SPACE QUALIFIED/APPROVALS

- (For space range)
- SCC 3402 (ESA)
 - CNES

APPLICATIONS

- Civil & Military Telecommunications
- Civil & Military Aeronautics
- Military equipments
- Space
- Measurement systems

Interface

PLUG

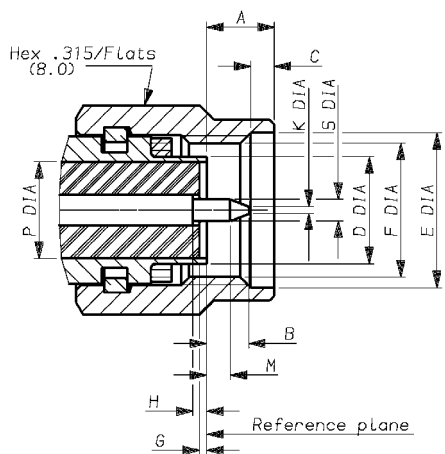

JACK

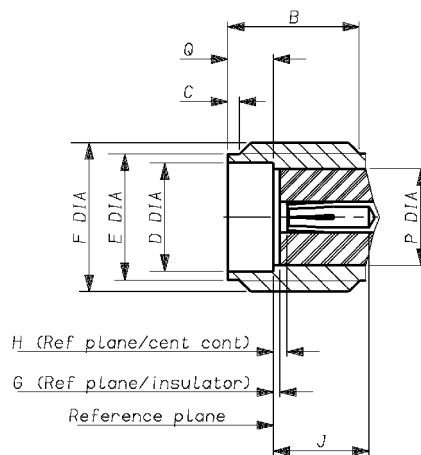

Letter	mm		inch	
	min.	max.	min.	max.
A		3.43		.135
B		2.54		.100
C	0.38	1.14	.015	.045
D DIA		4.59		
E	6.35		.250	
F DIA		1/4 36 UNS 2B		
G*	0.0	-0.20	0.0	-.008
H*	0.0	-0.25	0.0	-.010
J				
K DIA		0.38		.015
M	1.27		.050	
P DIA	4.10 nom.		.161 nom.	
Q DIA				
S DIA	0.90	0.94	.035	.037

Letter	mm		inch	
	min.	max.	min.	max.
A				
B	4.31		.170	
C	0.38	1.14	.015	.045
D DIA	4.596		.181	
E DIA	5.28	5.49	.208	.216
F DIA		1/4 36 UNS 2A		
G*	0.0	-0.20	0.0	-.008
H*	0.0	-0.25	0.0	-.010
J	2.92		.115	
K				
M				
P DIA	4.10 nom.		.161 nom.	
Q	1.88	1.98	.074	.078
S DIA				

*Note:
Means behind ref plane

Characteristics

Test / Characteristics	Values / Remarks
------------------------	------------------

ELECTRICAL CHARACTERISTICS

Impedance		50Ω						
Frequency range		DC - 18 GHz					Extended	
V.S.W.R. (typ.) • Straight connector • Right angle connector	Frequency	1 GHz	2.4 GHz	6 GHz	12.4 GHz	18 GHz	27 GHz	
	.085"	1.01	1.01	1.04	1.06	1.06	1.12	
	.141"	1.01	1.01	1.01	1.03	1.05	1.10	
	2.6/50S	1.05	1.07	1.12	1.15			
	5/50S	1.04	1.05	1.10	1.12			
	.085"	1.01	1.02	1.06	1.14			
	.141"	1.01	1.02	1.08	1.10			
	2.6/50S	1.06	1.15	1.18	1.24			
	5/50S	1.06	1.15	1.15	1.25			
	Insertion loss (typ.) dB • Straight connector • Right angle connector	.085"	0.03	0.03	0.05	0.08	0.10	0.15
		.141"	0.02	0.02	0.02	0.02	0.02	0.10
		2.6/50S	0.06√F (F in GHz) max					
5/50S		0.06√F (F in GHz) max						
.085"		0.04	0.04	0.04	0.08			
.141"		0.04	0.05	0.06	0.09			
2.6/50S		0.08	0.08	0.10	0.10			
5/50S		0.04	0.12	0.12	0.25			
RF leakage (dB max) • Connectors for semi-rigid cables solder attachment • Connectors for flexible cables crimp attachment • Receptacles			- 90 + F (GHz)					
			- 60 + F (GHz)					
			- 100 + F (GHz)					
Insulation resistance		5 000 MΩ min						
Contact resistance		After tests			Initial			
• Outer conductor		4 mΩ			3 mΩ			
• Inner conductor		3 mΩ			2 mΩ			
Working voltage in VRMS • Sea level • 70 000 ft (21000 m)	.085", RG 405, KS 1	.141", RG 402, KS 2	RG 174, 188, 316, KX 3, KX 22		RG 55, 142, 223, KX 23			
	350	500	250		335			
	85	125	65		85			
Dielectric withstanding voltage in VRMS		1000	1500	750	1000			
RF testing voltage at in VRMS		670	1000	500	670			

MECHANICAL CHARACTERISTICS

Durability	500 matings			
Force to engage and disengage	23 Ncm - (2 inch pounds)			
Recommended coupling nut torque	80 to 115 Ncm - (7 to 10 inch pounds)			
Coupling nut retention force	270 N - (60 Lbs)			
Cable retention force	.085", RG 405, KS 1	.141", RG 402, KS 2	RG 174, 188, 316, KX 3, KX 22	RG 55, 142, 223, KX 23
	135 N (30 Lbs)	270 N (60 Lbs)	110 N (25 Lbs)	180 N (40 Lbs)
Center contact retention force	• Axial			27 N
	• Torque			2.8 N

Characteristics

Test / Characteristics	Values / Remarks
ENVIRONMENTAL CHARACTERISTICS	
Temperature range • Standard models • Semi-rigid cables • R125 753 000	-65°C / + 165°C -65°C / +105°C -40°C / +100°C
Thermal shock	MIL STD 202, method 107, condition B
High temperature test	MIL STD 202, method 108
Corrosion (salt spray)	MIL STD 202, method 101, condition B
Vibration	MIL STD 202, method 204, condition D, 20g
Shock	MIL STD 202, method 213
Moisture resistance	MIL STD 202, method 106
Hermetic test	Down to 10 ⁻⁶ mmHg (Torr) leakage rate < 10 ⁻⁶ atm/cm ³ /sec
Barometric pressure	MIL STD 202, method 105, condition C

MATERIALS AND PLATING

	Material	Plating
Body/nut	Stainless steel	Passivated or Gold plated (bodies)
Center contacts	Beryllium copper (female) Brass (male)	Gold plated
Gaskets	Silicone rubber	
Insulators	PTFE	

Standard packaging: 100 pieces

All dimensions are given in mm.

Straight plugs

STRAIGHT PLUGS FOR FLEXIBLE CABLES

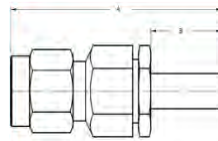
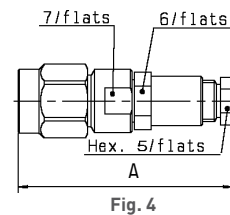
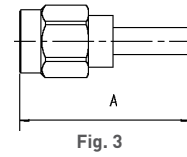
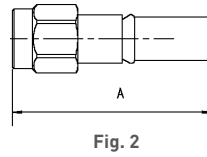
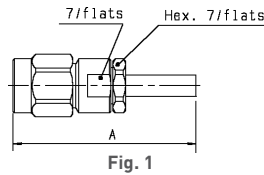

Cable group	Cable group dia.	Part number (Gold)	Part number (Passivated)	Fig.	Dimensions A (mm)	Captive center contact	Assembly type	Note		
RG178 / RG196	2/50/S	R125 069 000		1	26	yes	Crimp			
Special	2.2/50/D		R125 002 200	4	25	yes	Clamp			
RG174 / RG316	2.6/50/S	R125 071 120		3	24.3	yes	Crimp	Single piece body		
		R125 072 000	R125 072 001	2	21.1	no		Single piece body heatshrink sleeve		
		R125 073 000	R125 073 001	1	26	yes	Clamp			
		R125 091 000	R125 091 001	4	2	yes				
RD316	2.6/50/D	R125 072 080		2	20.1	no	Crimp	Single piece body heatshrink sleeve		
		R125 072 220		3	23.4	yes		Single piece body		
RG58 / RG141	5/50/S	R125 075 000		3	24.9	no	Crimp	Single piece body heatshrink sleeve		
		R125 077 000		1	28	yes				
RG142 / RG223 / RG400	5/50/D	R125 076 000	R125 076 001	3	25	no			Crimp	Single piece body heatshrink sleeve
		R125 078 000	R125 078 001	1	28	yes				

Straight plugs

STRAIGHT PLUGS FOR FLEXIBLE CABLES (CONT'D)

Cable group	Cable group dia.	Part number (Gold)	Part number (Passivated)	Fig.	Dimensions A (mm)	Dimensions B (mm)	Captive center contact	Assembly type	Note
RG178 / RG196	2/50/S	9001-1023-002	9001-9023-002	3	20.3		no	Crimp	For passivated version, coupling nut only is passivated
		9001-1033-002	9001-9033-002					Solder	
		9001-1553-002	9201-9553-002	5	19.5	0	yes	Clamp	
		9001-1573-002	9201-9573-002		29.5	9.5			
RD178	2/50/D	9001-1023-005	9001-9023-005	3	20.3		no		
		9001-1033-005	9001-9033-005					Solder	
		9001-1553-005	9001-9553-005	5	19.5	0	yes	Clamp	
		9001-1573-005	9001-9573-005		29.5	9.5		Crimp	
RG174/RG316	2.6/50/S	9001-1023-003	9001-9023-003	3	20.3		no		
		9001-1033-003	9001-9033-003					Solder	
		9001-1553-003	9001-9553-003	5	19.5	0	yes	Clamp	
		9001-1573-003	9001-9573-003		29.5	9.5			
RD316	2.6/50/D	9001-1023-019	9001-9023-019	3	20.3		no		
		9001-1033-019	9001-9033-019					Solder	
		9001-1553-019	9001-9553-019	5	19.5	0	yes	Clamp	
		9001-1573-019	9001-9573-019		29.5	9.5		Crimp	
RG58/RG141	5/50/S	9001-1023-006	9001-9023-006	3	20.3		no		
		9001-1033-006	9001-9033-006					Solder	
		9001-1553-006	9001-9553-006	5	19.5	0	yes	Clamp	
		9001-1573-006	9001-9573-006		29.5	9.5		Crimp	
RG142/RG223/RG400	5/50/D	9001-1023-001	9001-9023-001	3	20.3		no		
		9001-1033-001	9001-9033-001					Solder	
		9001-1553-001	9001-9553-001	5	19.5	0	yes	Clamp	
		9001-1573-001	9001-9573-001		29.5	9.5		Crimp	

STRAIGHT PLUGS SOLDER TYPE FOR SEMI-RIGID CABLES

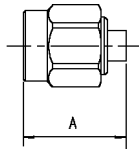

Fig. 1

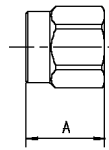

Fig. 2

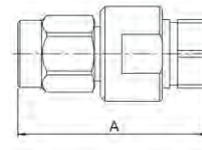

Fig. 3

Cable group	Cable group dia.	Part number (Gold)	Part number (Gold/Passivated coupling nut)	Part number (Nickel)	Fig.	Dimensions A (mm)	Captive center contact	Note
RG405	.085"	R125 052 000	R125 052 002		1	11.1	no	Single piece body
		R125 052 170						Loose parts
		R125 052 500						Retractable coupling nut / Single piece body
			R125 052 702					DC-27 GHz Single piece body
RG402	.141"	R125 054 000	R125 054 002		2	8.5	n/a	Without center contact
		R125 054 500				7.5	n/a	Without center contact / Retractable coupling nut
		R125 055 000	R125 055 002		1	11.2	no	Single piece body
		R125 055 500						Retractable coupling nut / Single piece body
			R125 055 702					DC-27 GHz without center contact
		R125 057 002			n/a	Without center contact		
RG401	.250"	R125 051 000			3	21.1	no	Two pieces body

Straight plugs

STRAIGHT PLUGS SOLDER TYPE FOR SEMI-RIGID CABLES (CONT'D)

Cable group	Cable group dia.	Part number (Gold)	Part number (Gold/Passivated coupling nut)	Part number (Nickel)	Fig.	Dimensions A (mm)	Captive center contact	Note
RG405	.085"	9501-1593-010	9501-9593-010		3	19.5	yes	Solder-Clamp
		9401-1083-010		9401-7083-010	1	11.2	no	Solder type
		9401-1083-210		9401-7083-210		8.4		
		9401-1583-010		9401-7583-010		11.2	yes/For one-step cable assembly	
RG402	.141"	9501-1593-009	9501-9593-009		3	19.5	yes	Solder-Clamp
		9401-1083-109		9401-7083-109	1	11.2	no	Solder type
		9401-1583-109		9401-7583-109			yes/For one-step cable assembly	
		9301-1063-009		9301-7063-009		8.4	n/a	Without center contact

STRAIGHT PLUGS CRIMP TYPE FOR SEMI-RIGID CABLES

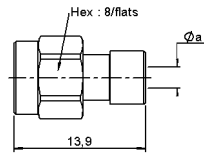

Fig. 1

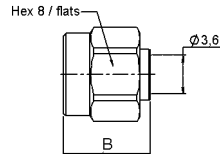

Fig. 2

Cable group	Cable group dia.	Part number (gold/passivated coupling nut)	Fig.	Dimensions A (mm)		Captive center contact	Note
				Ø a	B		
RG405	.085"	R125 052 901	1	2.2		yes	
RG402	.141"	R125 053 901	2		8.25	n/a	Retractable coupling nut
		R125 054 901	2		9.7	n/a	Without center contact
		R125 055 901	1	3.64			yes

Right angle plugs

RIGHT ANGLE PLUGS FOR FLEXIBLE CABLES

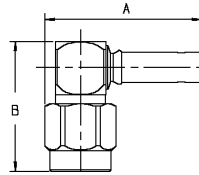

Fig. 1

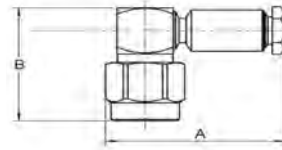

Fig. 2

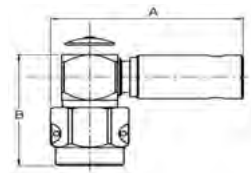

Fig. 3

Cable group	Cable group dia.	Part number (Gold)	Part number (Passivated)	Fig.	Dimensions (mm)		Captive center contact	Assembly type	Note		
					A	B					
RG178 / RG196	2/50/S	R125 170 402		1	19.6	16.85	yes	Crimp	Incl. heatshrink tube		
Special	2.2/50/D		R125 163 200	2	20.2	16.4		Clamp			
RG174 / RG316	2.6/50/S	R125 172 000	R125 172 001	1	19.6			16.4	Crimp	Incl. heatshrink tube	
RD316	2.6/50/D	R125 174 000		1	18.6						
RG58 / RG141	5/50/S	R125 175 000	R125 175 001	2	21.8						
		R125 176 000	R125 176 001	2							
RG142 / RG223 / RG400	5/50/D	R125 176 505		3							Lock wire hole nut Incl. heatshrink tube
RG178/RG196	2/50/S	9043-1523-002	9043-9523-002	1	19.3				17	Crimp	
		9243-1553-002	9243-9553-002	2	18.8					Clamp	
		9043-1533-002		1	19.3					Solder	
RD178	2/50/D	9043-1523-005	9043-9523-005	1	19.3		Crimp				
		9243-1553-005	9243-9553-005	2	18.8	Clamp					
		9043-1533-005		1	19.3	Solder					
RG174/RG316	2.6/50/S	90431523-003	9043-9523-003	1	19.3	Crimp					
		9243-1553-003	9243-9553-003	2	18.8	Clamp					
		9043-1533-003		1	19.3	Solder					
RD316	2.6/50/D	9043-1523-019	9043-9523-019	1	19.3	Crimp					
		9243-1553-019	9243-9553-019	2	18.8	Clamp					
		9043-1533-019		1	19.3	Solder					
RG58/RG141	5/50/S	9043-1523-006	9043-9523-006	1	19.3	Crimp					
		9243-1553-006	9243-9553-006	2	18.8	Clamp					
		9043-1533-006		1	19.3	Solder					
RG142/RG223/RG400	5/50/D	9243-1553-001	9243-9553-001	2	18.8	Clamp					
		9043-1533-001		1	19.3	Solder					
		9043-1523-001	9043-9523-001	1	19.3	Crimp					

Right angle plugs

RIGHT ANGLE PLUGS FOR SEMI-RIGID CABLES

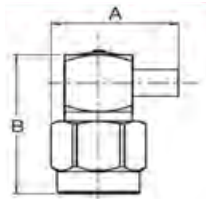

Fig. 1

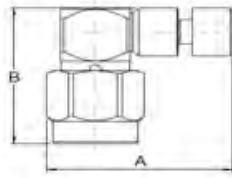

Fig. 2

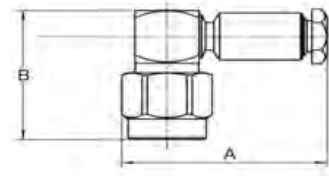

Fig. 3



Cable group	Cable group dia.	Part number (gold)	Part number (gold/passivated nut)	Fig.	Dimensions A (mm)	Dimensions B (mm)	Captive center contact	Assembly type
RG405	.085"	R125 153 000	R125 153 002	1	11.9	16.3	yes	Solder type
RG402	.141"	R125 154 000	R125 154 002					
RG405	.085"		R125 153 901	2	15.7	15.8		Crimp type
RG402	.141"		R125 154 901					
RG405	.085"	9443-1563-010		1	12.2	17		Solder type
RG402	.141"	9443-1563-009						
RG405	.085"	9543-1593-010	9543-9593-010	3	18.8	17.5	Solder-Clamp	
RG402	.141"	9543-1593-009	9543-9593-009					

Straight jacks

STRAIGHT JACKS FOR FLEXIBLE CABLES

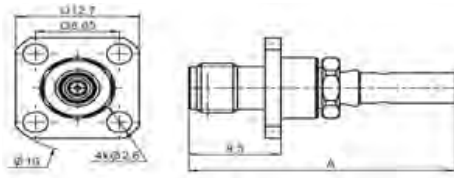

Fig. 1

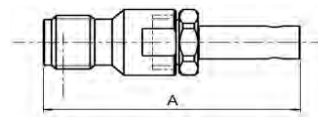

Fig. 2

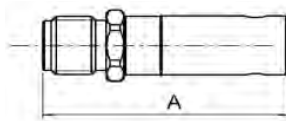

Fig. 3

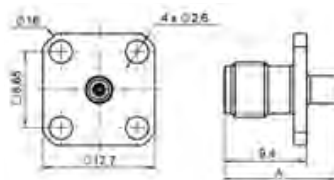

Fig. 4

Cable group	Cable group dia.	Part number (Gold)	Part number (Passivated)	Fig.	Dimensions A (mm)	Captive center contact	Panel drilling	Note
RG174 / RG316	2.6/50/S	R125 236 000		2	25.05	yes		Crimp or solder
		R125 272 000		1	27.5		P03	Square flange
RG58 / RG141	5/50/S	R125 237 000		3	23.1	no		
		R125 277 000		1	28.9		P03	Square flange
RG142 / RG223 / RG400	5/50/D	R125 238 000		3	23.1			

Straight jacks

STRAIGHT JACKS FOR FLEXIBLE CABLES (CONT'D)

Cable group	Cable group dia.	Part number (Gold)	Part number (Passivated)	Fig.	Dimensions A (mm)	Captive center contact	Panel drilling	Note
RG178 / RG196	2/50S	9002-1023-002	9002-9023-002	3	20.3	no		Crimp type
		9002-1033-002			20.3			Solder type
		9102-1573-002	9102-9573-002	2	27.9	yes		Crimp type
		9031-1023-002	9031-9023-002	4	21	no	P03	Crimp type-square flange
		9031-1033-002			21			Solder type-square flange
		9131-1573-002	9131-9573-002	1	27.4	yes		Crimp type-square flange
RD178	2/50/D	9002-1023-005	9002-9023-005	3	20.3	no		Crimp type
		9002-1033-005			20.3			Solder type
		9102-1573-005	9102-9573-005	2	27.9	yes		Crimp type
		9031-1023-005	9031-9023-005	4	21	no	P03	Crimp type-square flange
		9031-1033-005			21			Solder type-square flange
		9131-1573-005	9131-9573-005	1	27.4	yes		Crimp type-square flange
RG174 / RG316	2.6/50S	9002-1023-003	9002-9023-003	3	20.3	no		Crimp type
		9002-1033-003			20.3			Solder type
		9102-1573-003	9102-9573-003	2	27.9	yes		Crimp type
		9031-1023-003	9031-9023-003	4	21	no	P03	Crimp type-square flange
		9031-1033-003			21			Solder type-square flange
		9131-1573-003	9131-9573-003	1	27.4	yes		Crimp type-square flange
RD316	2.6/50D	9002-1023-019	9002-9023-019	3	20.3	no		Crimp type
		9002-1033-019			20.3			Solder type
		9102-1573-019	9102-9573-019	2	27.9	yes		Crimp type
		9031-1023-019	9031-9023-019	4	21	no	P03	Crimp type-square flange
		9031-1033-019			21			Solder type-square flange
		9131-1573-019	9131-9573-019	1	27.4	yes		Crimp type-square flange
RG58 / RG141	5/50S	9002-1023-006	9002-9023-006	3	20.3	no		Crimp type
		9102-1573-006	9102-9573-006	2	27.9			yes
		9002-1033-006		3	20.3	no		Crimp type-square flange
		9031-1023-006	9031-9023-006	4	21			Solder type-square flange
		9031-1033-006			21			
		9131-1573-006	9131-9573-006	1	27.4	yes	Crimp type-square flange	
RG142 / RG223 / RG400	5/50D	9002-1033-001		3	20.3	no		Solder type
		9102-1573-001	9102-9573-001	2	27.9			yes
		9031-1023-001	9031-9023-001	4	21	no	P03	Crimp type-square flange
		9031-1033-001			21			Solder type-square flange
		9131-1573-001	9131-9573-001	1	27.4	yes		Crimp type-square flange
		9002-1023-001	9002-9023-001	3	20.3	no		Crimp type

Straight jacks

STRAIGHT JACKS FOR SEMI-RIGID CABLES

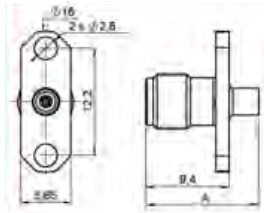

Fig. 1

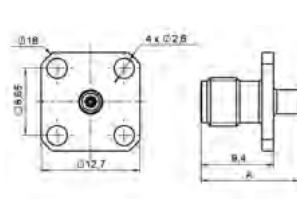

Fig. 2

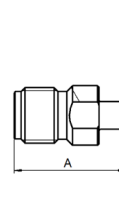

Fig. 3

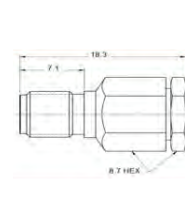

Fig. 4

Cable group	Cable group dia.	Part number (Gold)	Part number (Passivated)	Part number (Nickel)	Fig.	Dimensions	Captive center contact	Panel drilling	Note	
						A (mm)				
RG405	.085"	R125 222 000			3	12.7	no	P02	2 hole flange	
		R125 252 000			1				Square flange	
		R125 256 000			2					
RG402	.141"	R125 225 000			3	12.7	no	P02	2 hole flange	
		R125 251 000			1				Square flange	
		R125 255 000			2					
RG405	.085"	9402-1083-010		9402-7083-010	3	15.2	yes	P03	Solder type	
						12.7	no			
		9402-1583-010		9402-7583-010	2	13.9	yes/for one-step cable assembly			yes/for one-step cable assembly
		9431-1083-010		9431-7083-010						no
		9431-1583-010		9431-7583-010						yes/for one-step cable assembly
		9441-1083-010		9441-7083-010	1	13.9	yes/for one-step cable assembly			no
		9441-1583-010		9441-7583-010						yes/for one-step cable assembly
9502-1593-010	9502-9593-010		4	yes		Solder-Clamp type				
RG402	.141"	9402-1083-009		9402-7083-009	3	12.7	no	P03	Solder type	
						12.7	yes/for one-step cable assembly			
		9431-1083-009		9431-7083-009	2	13.9	yes/for one-step cable assembly			no
		9431-1583-009		9431-7583-009						yes/for one-step cable assembly
		9441-1083-009		9441-7083-009						no
		9441-1583-009		9441-7583-009	1	13.9	yes/for one-step cable assembly			P02
		9502-1593-009	9502-9593-009		4	yes				Solder-Clamp type

Bulkhead jacks

STRAIGHT BULKHEAD JACKS FOR FLEXIBLE CABLES (rear mount)

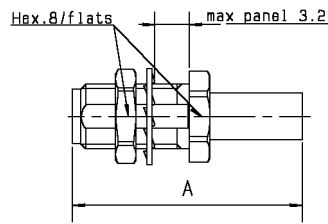

Fig. 1

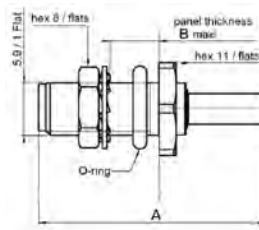

Fig. 2

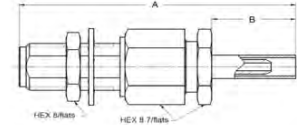
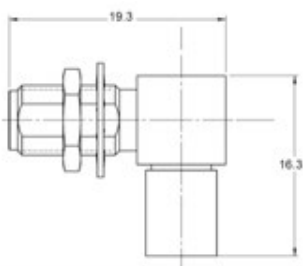

Fig. 3

Cable group	Cable group dia.	Part number (Gold)	Part number (Passivated)	Fig.	Dimensions (mm)		Captive center contact	Panel drilling	Note
					A	B			
RG178 / RG196	2/50/S	R125 320 020		2	26.1	5.6			Totally waterproof
RG174 / RG316	2.6/50/S	R125 303 000	R125 303 001	1	25.7				Crimp and solder Heatshrink sleeve
		R125 312 120			22.4				Full crimp
		R125 321 020		2	23.7	3.2			Totally waterproof
RD316	2.6/50/D	R125 313 120		1	22.4		yes		Full crimp
		R125 322 030		2		3.2			Panel sealed
RG58 / RG141	5/50/S	R125 314 120		1	25.4			Full crimp	
RG142 / RG223 / RG400	5/50/D	R125 315 120		1	29.6				Crimp and solder
		R125 308 000							Crimp type
RG178 / RG196	2/50/S	9030-1023-002	9030-9023-002		23.9		no		Crimp type
		9030-1033-002							Solder type
		9130-1573-002	9130-9573-002	3	30.5	9.5	yes		Crimp type
		9230-1553-002	9230-9553-002		21	0			Clamp type
RD178	2/50/D	9030-1023-005	9030-9023-005	1	23.9		no		Crimp type
		9030-1033-005							Solder type
		9130-1573-005	9130-9573-005	3	30.5	9.5	yes		Crimp type
		9230-1553-005	9230-9553-005		21	0			Clamp type
RG174 / RG316	2.6/50/S	9030-1023-003	9030-9023-003	1	23.9		no		Crimp type
		9030-1033-003							Solder type
		9130-1573-003	9130-9573-003	3	30.5	9.5	yes		Crimp type
		9230-1553-003	9230-9553-003		21	0			Clamp type
RD316	2.6/50/D	9030-1023-019	9030-9023-019	1	23.9		no		Crimp type
		9030-1033-019							Solder type
		9130-1573-019	9130-9573-019	3	30.5	9.5	yes		Crimp type
		9230-1553-019	9230-9553-019		21	0			Clamp type
RG58 / RG141	5/50/S	9030-1023-006	9030-9023-006	1	23.9		no		Crimp type
		9030-1033-006							Solder type
		9130-1573-006	9130-9573-006	3	30.5	9.5	yes		Crimp type
		9230-1553-006	9230-9553-006		21	0			Clamp type
RG142 / RG223 / RG400	5/50/D	9030-1023-001	9030-9023-001	1	23.9		no		Crimp type
		9030-1033-001							Solder type
		9130-1573-001	9130-9573-001	3	30.5	9.5	yes		Crimp type
		9230-1553-001	9230-9553-001		21	0			Clamp type

Bulkhead jacks

RIGHT ANGLE BULKHEAD JACKS CRIMP TYPE FOR FLEXIBLE CABLES (rear mount)



Cable group	Cable group dia.	Part number (Gold)	Part number (Passivated)	Captive center contact	Panel drilling	Note
RG178 / RG196	2/50S	9613-1523-002	9613-9523-002	yes	P06	Crimp type
RD178	2/50D	9613-1523-005	9613-9523-005			
RG174 / RG316	2.6/50S	9613-1523-003	9613-9523-003			
RD316	2.6/50D	9613-1523-019	9613-9523-019			
RG58 / RG141	5/50S	9613-1523-006	9613-9523-006			
RG142 / RG223 / RG400	5/50D	9613-1523-001	9613-9523-001			

BULKHEAD JACKS SOLDER TYPE FOR SEMI-RIGID CABLES (rear mount)

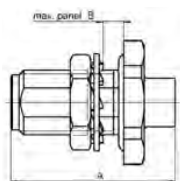
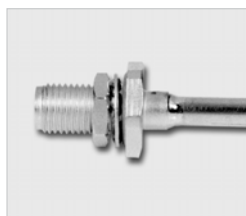

Fig. 1

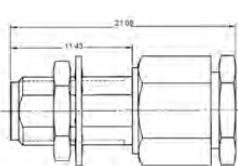

Fig. 2

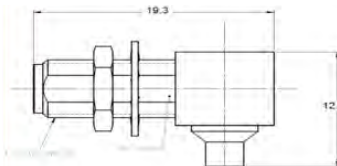

Fig. 3

Cable group	Cable group dia.	Part number (Gold)	Part number (Nickel)	Part number (Passivated)	Fig.	Dimensions A (mm)	Dimensions B (mm)	Captivecenter contact	Panel drilling	Note
RG405	.085"	R125 326 000			1	16	2.4	no	P06	Panel sealed
RG402	.141"	R125 325 000				17.1	3.5			Unsealed
		R125 305 000				17.8				Panel sealed
RG405	.085"	9453-1083-010	9453-7083-010		3	19.3	3.2	yes		Solder type
		9613-1563-010	9613-9563-010		1	17.8		yes/for one-step cable assembly	P06	Panel sealed
		9453-1583-010	9453-7583-010		2			yes		Solder-Clamp
RG402	.141"	9453-1583-009	9453-7583-009		1	17.8	3.2	yes/for one-step cable assembly		P06
		9530-1593-010		9530-9593-010	2			yes	Solder-Clamp	
		9453-1083-009	9453-7083-009		1	17.8		no	Panel sealed	
		9613-1563-009	9613-9563-009		3	19.3		yes	Solder type	

Receptacles

STRAIGHT FEMALE FLANGE RECEPTACLES - SOLDER POT

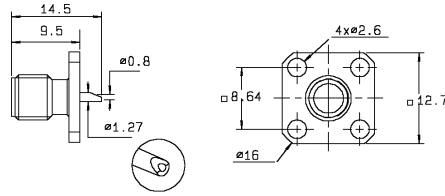

Fig. 1

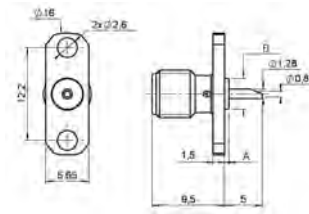

Fig. 2

Part number (Gold)	Part number (Passivated)	Fig.	Dimensions (mm)		Captive center contact	Panel drilling	Note
			A	B			
R125 403 000	R125 403 001	1			yes (4 indents)	P04	Square flange
R125 453 000		2	0.6	$\phi 4.06$		yes	P01
R125 454 000	R125 454 001						
9408-1113-000	9408-9113-000		0.8				
9408-1113-002	9408-9113-002		0		yes	P02	

STRAIGHT AND RIGHT ANGLE FEMALE SQUARE FLANGE RECEPTACLES - SOLDER POT

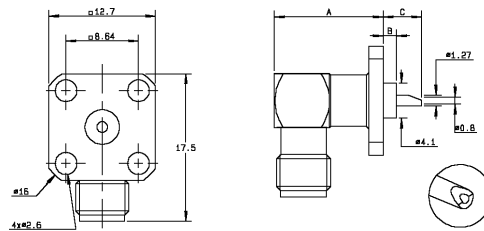

Fig. 1



Fig. 2

Part number (Gold)	Part number (Passivated)	Fig.	Dimensions (mm)			Captive center contact	Panel drilling
			A	B	C		
	R125 653 001	1	12.4	1.57	4.6	yes	P04
R125 654 000			11.1	0	6.1		
9424-1513-000	9424-9513-000		12.7	1.6	4.8		P03
9425-1513-000	9425-9513-000		9.1				
9407-1113-000	9407-9113-000	2					

Receptacles

BULKHEAD FEMALE RECEPTACLE (solder pot)

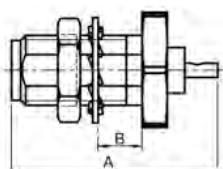

Fig. 1

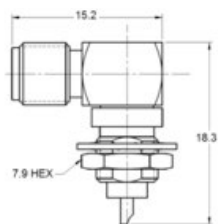

Fig. 2

Part number (Gold)	Part number (Passivated)	Fig.	Dimensions A (mm)	Dimensions B (mm)	Captive center contact	Panel drilling	Note
R125 553 000	R125 553 001	1	17.4	3.4	yes (2 indents)	P06	Rear mount
9412-1113-000	9412-9113-000		17.0	3.2	yes		Front mount
9422-1113-000	9422-9113-000						Rear mount, panel sealed
9432-1113-000	9432-9113-000	2					Right angle front mount
9609-1513-000	9609-9513-000						

SCREW-ON FEMALE RECEPTACLES (front mount)

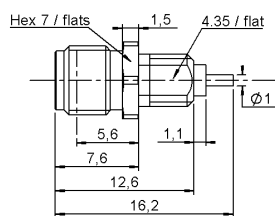

Fig. 1

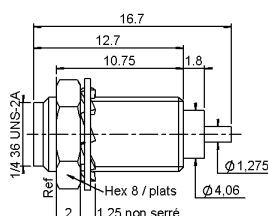

Fig. 2

Part number (gold)	Fig.	Captive center contact	Note
R125 555 500	1	yes	Screw-on
R125 560 000	2		

STRAIGHT MALE FLANGE RECEPTACLES (solder pot)

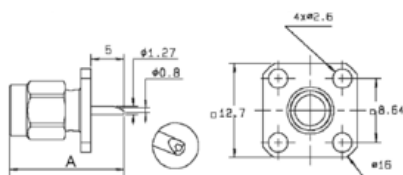

Fig. 1

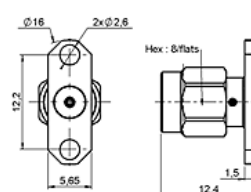
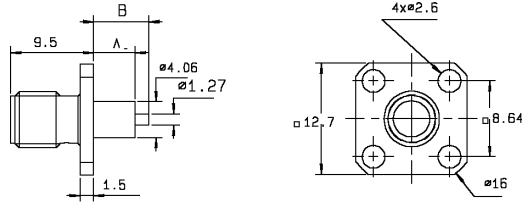
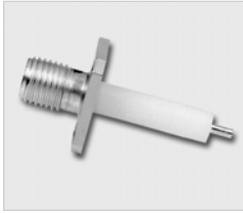

Fig. 2

Part number (Gold)	Fig.	Captive center contact	Dimensions A (mm)	Panel drilling	Note
R125 433 000	1	yes (4 indents)	17.4	P04	Square flange
R125 483 000	2			P01	2 hole flange
9404-1113-000	1	yes	14.5	P03	1/2" Square flange
9476-1113-000				P11	3/8" Square flange

Receptacles

SQUARE FLANGE EXTENDED DIELECTRIC FEMALE RECEPTACLES



Part number (Gold)	Part number (Passivated)	Dimensions (mm)		Captive center contact	Panel drilling
		A	B		
R125 413 000	R125 413 001	12.7	15.9	no	P04
R125 414 000	R125 414 001			yes (epoxy)	
R125 414 004				yes (4 indents)	
R125 415 000	R125 415 001	18	20.5	yes (epoxy)	
R125 415 030		3.2	5.4	yes (4 indents)	
R125 415 275		15	17.9	yes (4 indents)	
R125 415 270	R125 415 271			yes (epoxy)	
R125 416 460				yes (epoxy)	
9004-1113-000	9004-9113-000	14.9	3	yes (4 indents)	
9004-1213-000				yes (square flange)	
	9076-9113-000			yes (4 incidents)	
	9007-9113-000				

2 HOLE FLANGE EXTENDED DIELECTRIC FEMALE RECEPTACLES

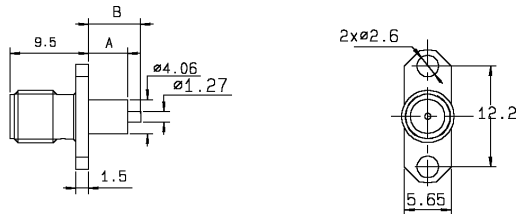
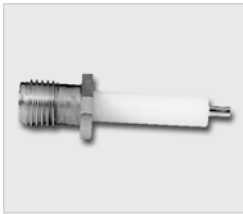

Part number (Gold)	Part number (Passivated)	Dimensions (mm)		Captive center contact	Panel drilling
		A	B		
R125 464 000	R125 464 001	12.7	15.9	yes (epoxy)	P01
R125 464 270	R125 464 271	15	17.9	yes (4 indents)	
R125 464 274				yes (4 indents)	
9008-1113-000		14.98	24.32	no	
9008-1213-000				yes (4 indents)	
	9008-9113-000				

RIGHT ANGLE FEMALE SQUARE FLANGE EXTENDED DIELECTRIC RECEPTACLES

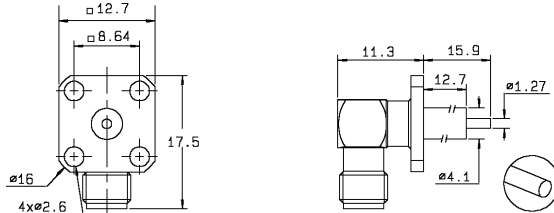
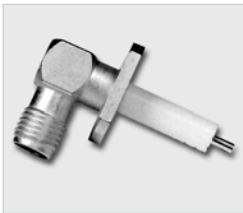

Part number (Gold)	Part number (Passivated)	Captive center contact	Panel drilling
R125 654 450	R125 654 451	yes	P04

Receptacles

STRAIGHT MALE FLANGE EXTENDED DIELECTRIC RECEPTACLES

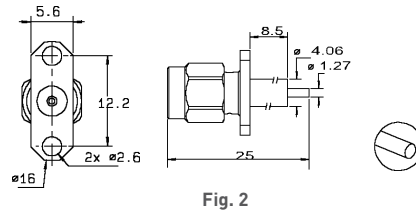
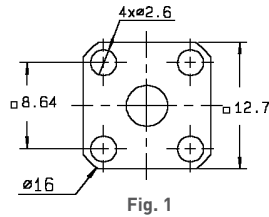
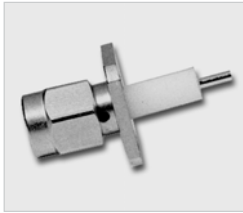

Part number (Gold)	Part number (Passivated)	Fig.	Captive center contact	Panel drilling	Note
R125 444 000	R125 444 001	1	yes (epoxy)	P04	Square flange
R125 474 000	R125 474 001	2		P01	2 hole flange

PCB FEMALE RECEPTACLES

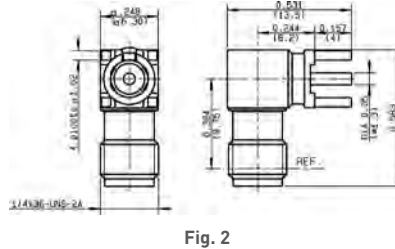
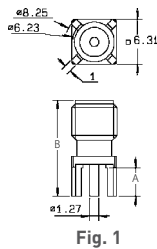

Part number (Gold)	Fig.	Dimensions (mm)		Captive center contact	PCB pattern	Note
		A	B			
R125 426 000	1	4	13.5	yes	P05	Selective tin plating
R125 426 140		6.9	14.4			
R125 680 000	2					

STRAIGHT FEMALE SQUARE FLANGE RECEPTACLES - TAB CONTACT

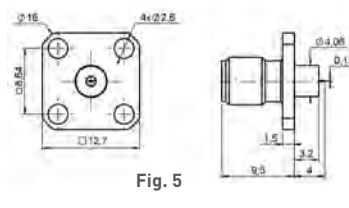
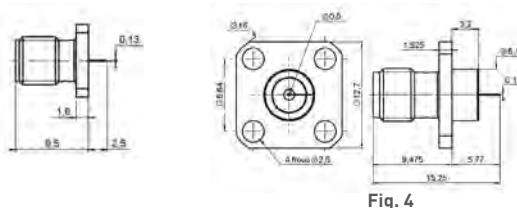
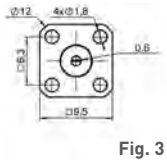
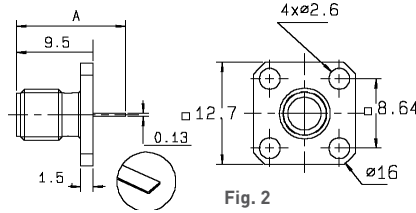
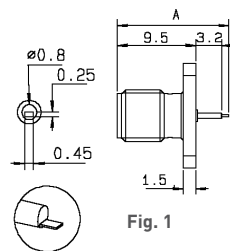

Part number (Gold)	Part number (Passivated)	Fig.	Dimensions A (mm)	Captive center contact	Panel drilling	Contact type
R125 501 000	R125 501 001	1	13.5	yes (epoxy)	P04	Offset tab
R125 510 000	R125 510 001	2	12		P11	Tab
R125 510 500	R125 510 501	3	2.5			
R125 612 120		4			P04	Tab
R125 620 000		2	10.38			
R125 622 000		5				
	R125 943 001	3	0.89		P11	

Receptacles

STRAIGHT AND RIGHT ANGLE FEMALE 2 HOLE FLANGE RECEPTACLES - TAB CONTACT

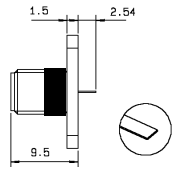
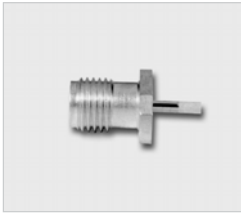

Fig. 1

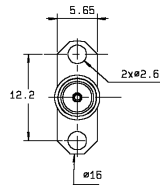

Fig. 2

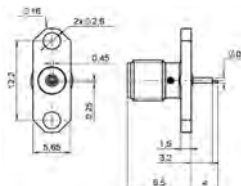

Fig. 3

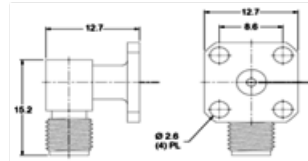
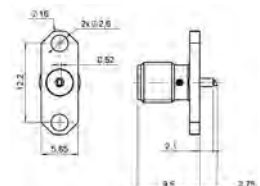

Fig. 4

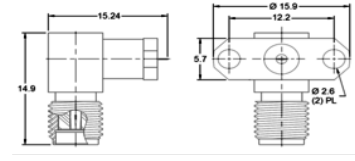
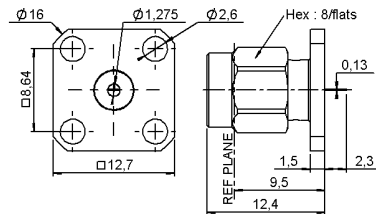

Fig. 5

Part number (Gold)	Part number (Passivated)	Fig.	Captive center contact	Panel drilling	Contact type
R125 451 000		2	yes (epoxy)	P01	Offset tab
R125 452 000		3			Special
R125 497 000		1			Tab
9124-1513-000	9124-9513-000	4	yes	P03	Tab contact 1.3mm width
9126-1513-000	9126-9513-000	5		P01	

STRAIGHT MALE SQUARE FLANGE RECEPTACLES - TAB CONTACT



Part number (Gold)	Part number (Passivated)	Captive center contact	Panel drilling	Note
R125 488 000	R125 488 001	yes (epoxy)	P04	Unit packaging

STRAIGHT FEMALE SQUARE FLANGE RECEPTACLES - CYLINDRICAL CONTACT

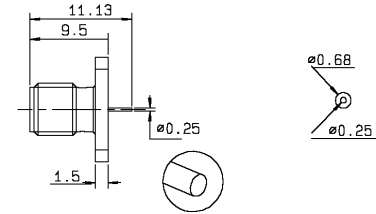
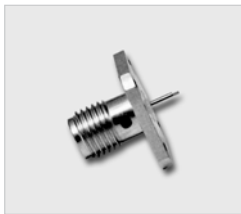

Part number (Gold)	Captive center contact	Panel drilling	Note
R125 610 000	yes (epoxy)	P04	Unit packaging

Receptacles for microstrip

STRAIGHT FEMALE FLANGE RECEPTACLES - CYLINDRICAL CONTACT

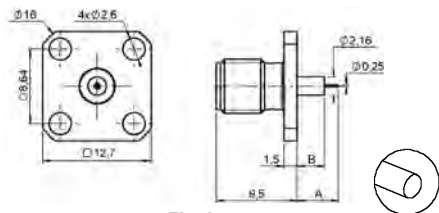
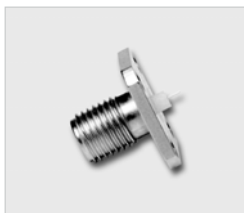

Fig. 1

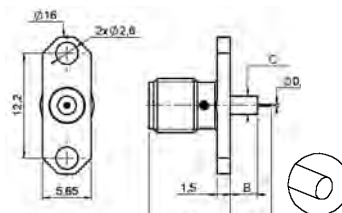

Fig. 2

Part number (Gold)	Part number (Passivated)	Fig.	Dimensions (mm)			Captive center contact	Panel drilling	Note	Captivation
			A	B	C				
R125 512 000	R125 512 001	1	4.8	3.2		yes	P04	Square flange	4 indents
R125 513 000			3.2	1.6					Epoxy
R125 462 000	R125 462 001	2	4.8	3.2	2.16		P01	2 hole flange	Epoxy
R125 463 000			3.2	1.6	2.16				
	R125 617 001		4.8	3.2	4.06				

STRAIGHT MALE FLANGE RECEPTACLES - CYLINDRICAL CONTACT

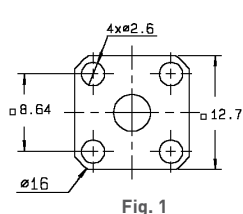

Fig. 1

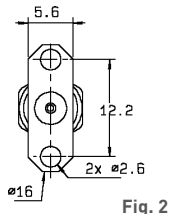
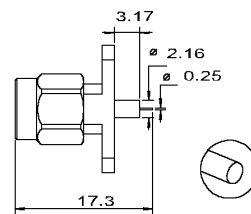

Fig. 2



Part number (Gold)	Part number (Passivated)	Fig.	Captive center contact	Panel drilling	Note
R125 492 000	R125 492 001	1	yes (epoxy)	P04	Square flange
R125 484 000	R125 484 001	2		P01	2 hole flange

Receptacles for microstrip

UNIVERSAL FIELD-REPLACEABLE RECEPTACLES - FEMALE SOCKET
(accept pin 0.93 mm [.037"])

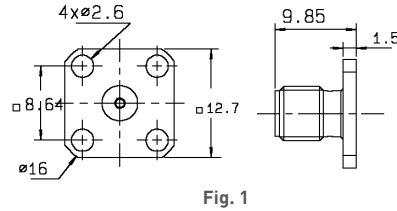

Fig. 1

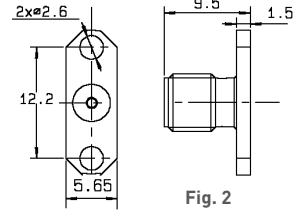

Fig. 2

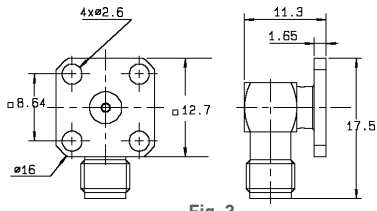

Fig. 3

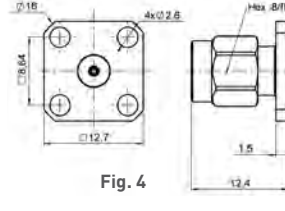

Fig. 4

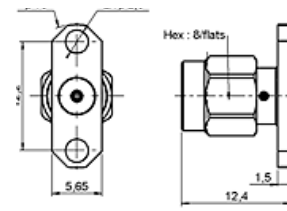

Fig. 5

Part number (Gold)	Part number (Passivated)	Fig.	Captive center contact	Panel drilling	Note
R125 410 000	R125 410 001	1	yes (epoxy)	P04	female-square flange
	R125 430 001	4			male-square flange
R125 460 000	R125 460 001	2		P01	female-2 hole flange - Unit packaging
	R125 480 001	5			male-2 hole flange
	R125 670 001	3		P04	female-right angle square flange

EDGE CARD RECEPTACLES

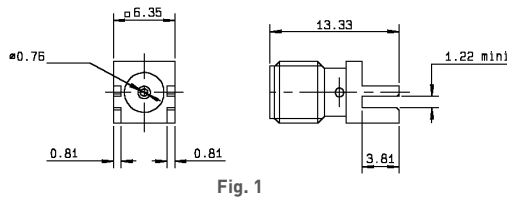
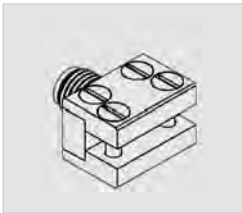

Fig. 1

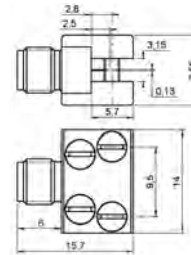
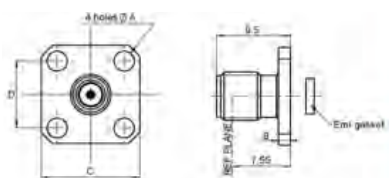

Fig. 2

Part number (Gold)	Part number (Passivated)	Fig.	Captive center contact	Note	Captivation
R125 423 200		1	yes	Solder pins	4 indents
R125 541 000	R125 541 001	2		4 screws	Epoxy

Hermetic receptacles with separate glass bead

SQUARE FLANGE 12.7 mm FEMALE RECEPTACLE



Part number (Gold)	Part number (Passivated)	Glass bead only	Dimensions (mm)				EMI gasket only	Panel drilling connector	Panel drilling glass bead	Note
			A	B	C	D				
R125 411 000	R125 411 001	R280 751 000	2.6	1.5	12.7	8.6	R280 510 000	P10	P13	Diameter pin=0.30
9074-9513-000			1.7	1.6	9.5	6.3				Diameter pin=0.45
9079-9513-000										Diameter pin=0.30
9079-9513-001										Diameter pin=0.38

NARROW FLANGE FEMALE RECEPTACLES

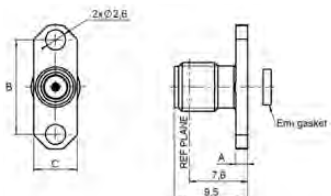

Part number (Gold plated)	Part number (Passivated)	Glass bead only	Dimensions (mm)			EMI gasket only	Panel drilling connector	Panel drilling glass bead	Note	
			A	B	C					
R125 465 000	R125 465 001	R280 751 000	1.5	12.2	5.6	R280 510 000	P12	P13		
R125 465 010	R125 465 011	R280 757 070						P18		
	9080-9513-000	920-55	1.6	10.2	4.7	No EMI gasket			Diameter Pin = 0.30	
	9180-9513-000	920-55 (included)								
	9180-9513-001	920-82 (included)								
	9144-9513-000	920-55 (included)	12.2	5.7	Contact Us	P12			Diameter Pin = 0.38	

NARROW FLANGE MALE RECEPTACLES

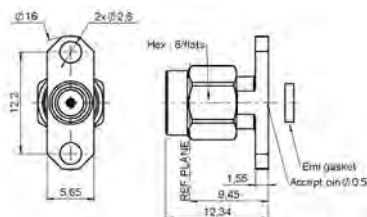

Part number (Passivated)	Glass bead only	EMI gasket only	Panel drilling connector	Panel drilling glass bead
R125 481 001	R280 751 000	R280 510 000	P12	P13
R125 481 011	R280 757 070			P18
9050-9513-000	920-56	Contact Us		

Hermetic receptacles with integrated glass bead

SCREW-ON TYPE FEMALE RECEPTACLES

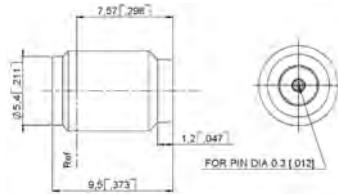
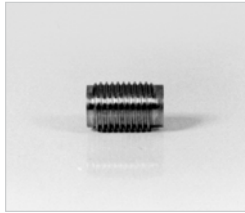

Fig. 1

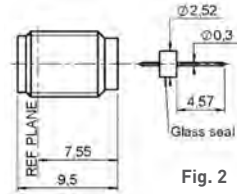
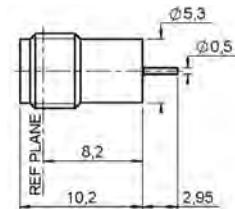

Fig. 2

Part number (Passivated)	Glass bead only	Fig.	Assembly tool	Panel drilling glass bead	Note
R125 556 001	R280 751 000	1	R282 341 010	P15	For pin dia 0.3/0.12
R125 556 011	R280 755 000			P19	For pin dia 0.5/0.19
R125 638 001	R280 751 350	2		P15	Supplied with glass bead

SOLDER TYPE FEMALE RECEPTACLE

Panel feedthrough receptacles feature an internal hermetic glass bead. A ring of solder between the receptacle body and the package will provide the hermeticity level.



Part number (Gold)	Connector body	Panel drilling	Contact type
R125 630 000	FN42 alloy		Cylindrical
R125 630 040	Stainless steel		

SCREW-ON TYPE FEMALE RECEPTACLE

Screw-on receptacles with integrated glass seal - the compression gasket will ensure the hermeticity between the receptacle and the package.

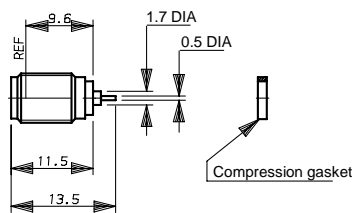

Part number (Gold)	Part number (Passivated)	Connector body	Panel drilling	Contact type
R125 609 000	R125 609 001	Stainless steel	P05	Cylindrical

SCREW-ON TYPE FEMALE RECEPTACLE WITH SLIDING CONTACT

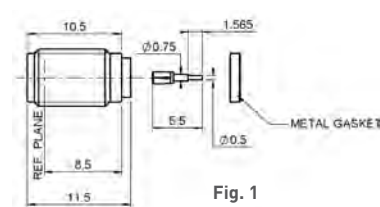
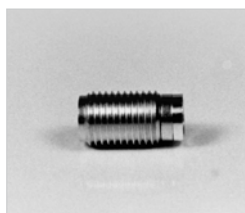

Fig. 1

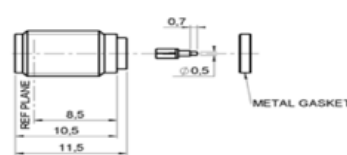

Fig. 2

Part number (Passivated)	Fig.	Connector body	Panel drilling	Contact type
R125 609 031	1	Stainless steel	P05	Cylindrical
R125 609 011	2			

Hermetic receptacles without glass bead

SCREW-ON TYPE FEMALE RECEPTACLE WITH SLIDING CONTACT

Screw-on receptacles without glass bead provide a lower hermeticity level (10⁻⁶atm/cm³/sec). A gasket is provided to guarantee the hermeticity between the receptacle and the package.

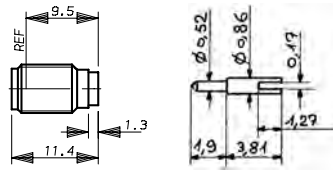

Part number (Gold)	Part number (Passivated)	Panel drilling	Contact type
R125 605 300	R125 605 301	P08	Slotted

Adapters

IN SERIES ADAPTERS

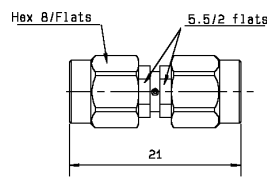

Fig. 1

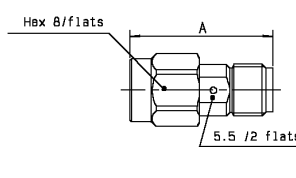

Fig. 2

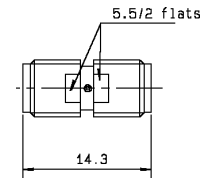

Fig. 3

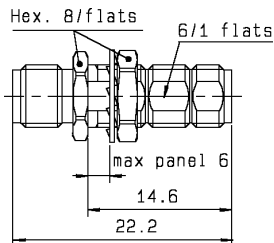

Fig. 4

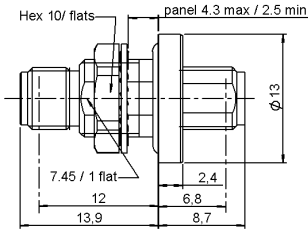

Fig. 5

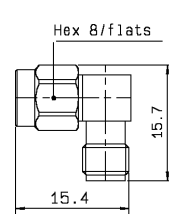

Fig. 6

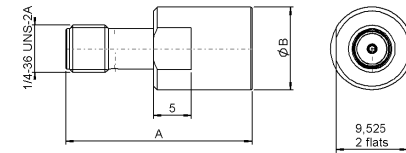

Fig. 7

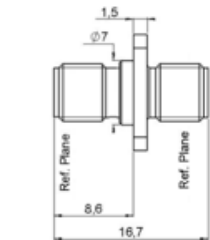

Fig. 8

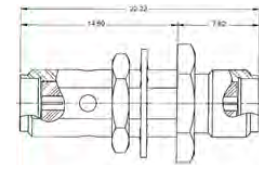
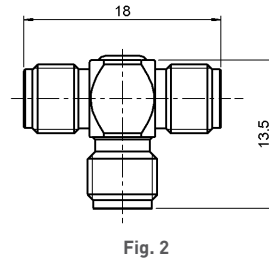
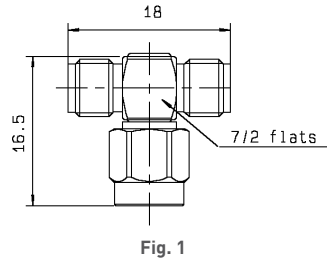

Fig. 9

Part number (Gold)	Part number (Passivated)	Fig.	Dimensions (mm)		Captive center contact	Panel drilling	Note	
			A	B				
R125 703 000	R125 703 001	1					male-male	
R125 704 000	R125 704 001	2	17.5		yes (4 indents)		male-female	
R125 705 000	R125 705 001	3					female-female	
R125 720 000	R125 720 001	4			yes (epoxy)	P06	Bulkhead female-female	
R125 753 000	R125 753 001	5			yes	P08	Bulkhead hermetically sealed female-female	
R125 771 000	R125 771 001	6					Right angle male-female	
	R125 791 501	7	23.3	8.9	yes (epoxy)	P07	PUSH-ON male	
	R125 792 501		24.8	11			PUSH-ON female	
	R125 710 021	8				P06	female-female square flange adapter	
5909-1103-000	5909-9103-000	9					bulkhead female-female	
5916-1103-603	5916-9103-603	2	17.4		yes (4indents)		male-female	
5917-1103-000	5917-9103-000	3					female-female	
5918-1103-000	5918-9103-000	1					male-male	
5919-1503-000	5919-9503-000	6						male-female / right angle
5919-1503-001	5919-9503-001							male-male / right angle
5919-1503-003	5919-9503-003							male-male / right angle

Adapters

TEE IN SERIES ADAPTERS



Part number (Gold)	Part number (Passivated)	Fig.	Type	Captive center contact
R125 780 000	R125 780 001	1	M/F-F	yes
R125 781 000	R125 781 001	2	F/F-F	

Accessories

MALE AND FEMALE CAPS

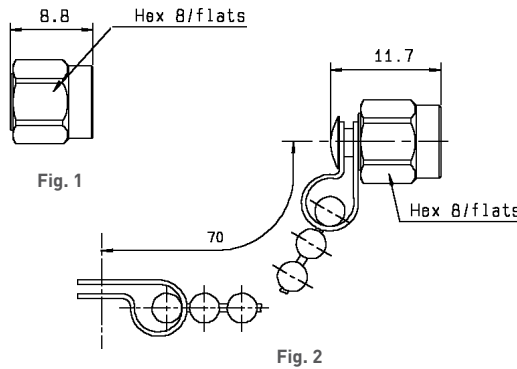

Part number (Gold)	Part number (Passivated)	Fig.	Note
R125 802 000	R125 802 001	1	male
R125 812 000	R125 812 001	2	male with chain
R125 852 000	R125 852 001	1	male short circuit
R125 845 000	R125 845 001	3	female with cord

CENTER CONTACTS (To be used with universal receptacle)

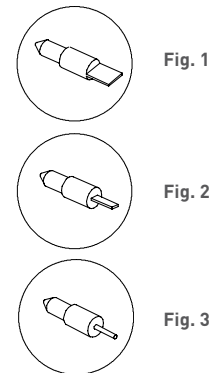
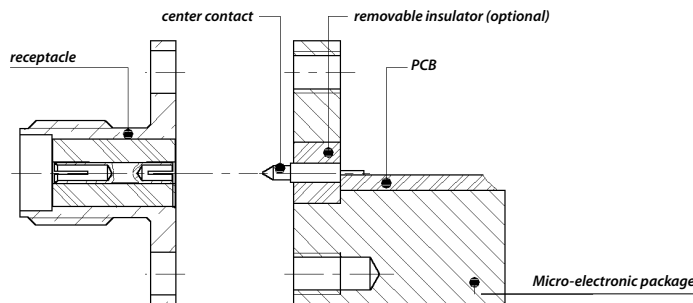

Part number	Fig.	Termination	Dimensions (mm)			Packaging
			A	B	C	
R280 461 000	1	Tab	3.37	0.13	1.6	10 pieces
R280 461 200	2	Tab special	3.37	0.13 x W0.51	1.6	
R280 461 210	1	Tab	10.3	0.13	1.6	
R280 462 000	3	Cylindrical	1.77	dia 0.25	1.57	
R280 463 000	3	Cylindrical	3.37	dia 0.25	1.57	
R280 465 000	2	Tab special	0.2	0.13 x W0.60	0.9	

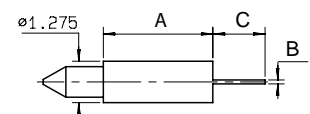

Glass beads

GLASS BEADS FOR HERMETIC RECEPTACLES

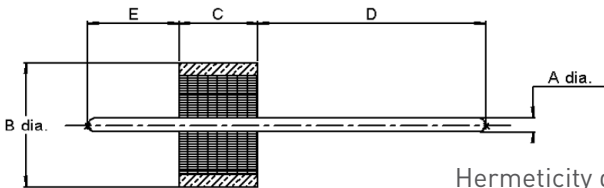
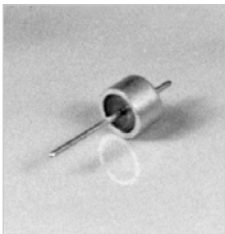

Hermeticity guaranteed at 10⁻⁸ atm.cm³/s

Part number	Dimensions mm (inch)					Packaging
	A	B	C	D	E	
R280 751 000	0.30 (.012)	2.52 (.099)	1.60 (.063)	4.57 (.180)	1.83 (.072)	1
R280 751 080				1.3 (.051)		100
R280 751 350				4.57 (.180)		1
R280 752 000	0.38 (.015)	2.50 (.098)	1.56 (.061)	1.95 (.076)	1.59 (.062)	100
R280 752 020				1.3 (.051)		
R280 755 000	0.46 (.018)	2.85 (.112)	1.60 (.063)	4.57 (.180)	1.83 (.072)	1
R280 755 040		2.85 (.111)				
R280 757 070	0.50 (.019)	4 (.157)	1.77 (.070)	1.78 (.070)	2.03 (.080)	100
R280 757 080				5.82 (.230)	1.93 (.076)	1

Go to page 17-18 for more glass beads.

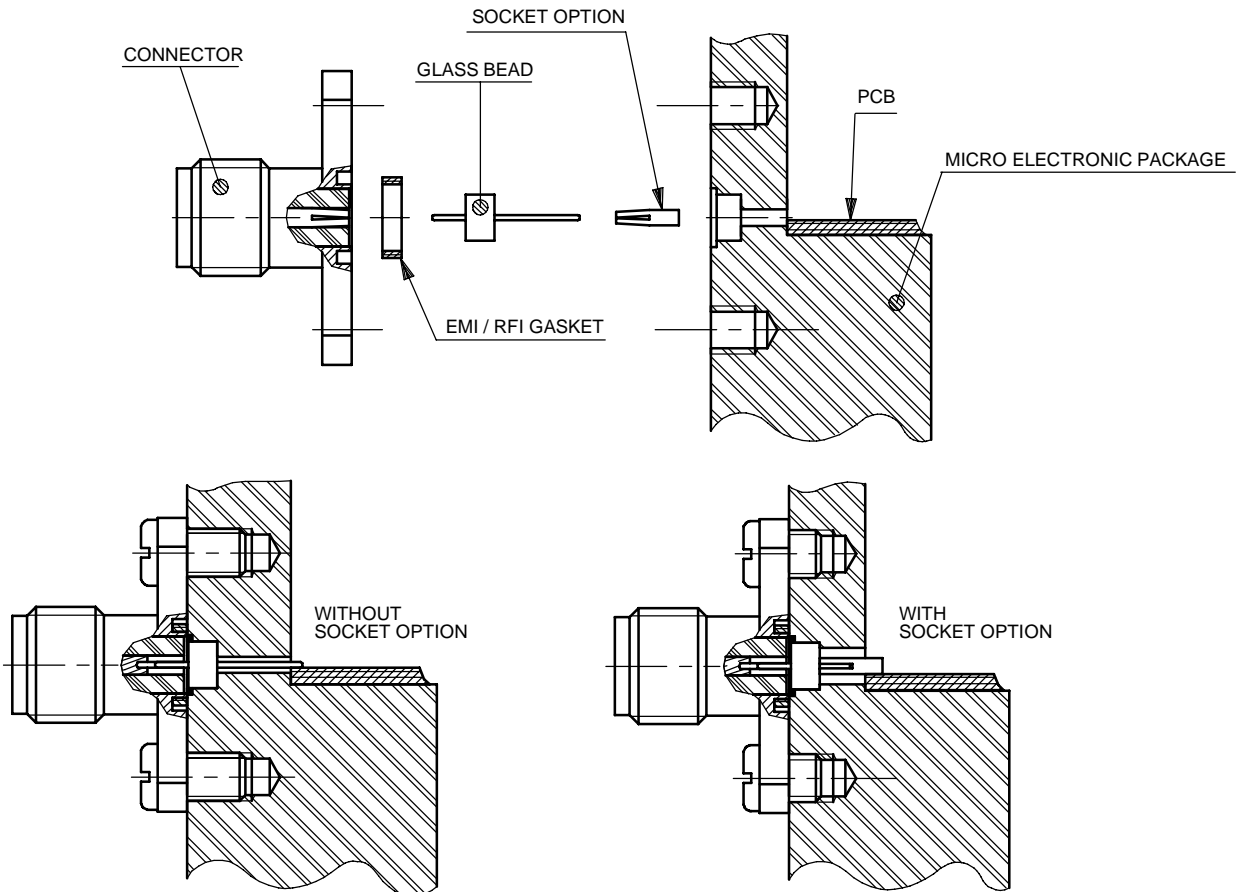

Accessories for hermetic microstrip receptacles

OPTIONAL SOCKET

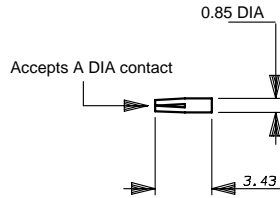

Part number	A Dia (mm)	Packaging
R280 469 000	0.30	10 pieces
R280 469 010	0.46	

Go to chapter 19-A for more socket contact options.

For use with glass seal.

Panel drilling

PO1

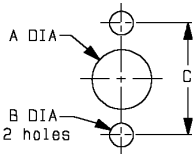

	MM		INCH	
	maxi	mini	maxi	mini
A	4.2	4.1	0.165	0.161
B	2.7	2.6	0.106	0.102
C	12.25	12.15	0.482	0.478

PO2

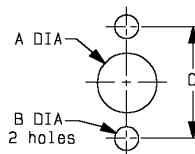

	MM		INCH	
	maxi	mini	maxi	mini
A	6.6	6.5	0.26	0.256
B	2.7	2.6	0.106	0.102
C	12.25	12.15	0.482	0.478

PO3

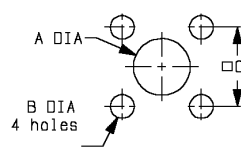

	MM		INCH	
	maxi	mini	maxi	mini
A	6.6	6.5	0.26	0.256
B	2.7	2.6	0.106	0.102
C	8.69	8.59	0.342	0.338

PO4

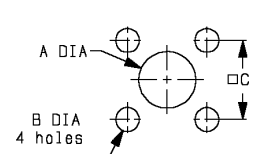

	MM		INCH	
	maxi	mini	maxi	mini
A	4.3	4.2	0.169	0.165
B	2.7	2.6	0.106	0.102
C	8.69	8.59	0.342	0.338

PO5

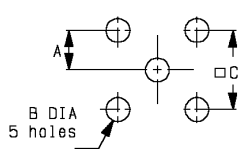

	MM		INCH	
	maxi	mini	maxi	mini
A	2.59	2.49	0.102	0.098
B	1.7	1.6	0.067	0.063
C	5.13	5.03	0.202	0.198

PO6

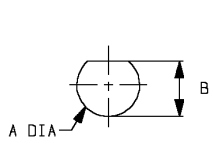

	MM		INCH	
	maxi	mini	maxi	mini
A	6.5	6.4	0.256	0.252
B	6.14	6	0.242	0.236

PO7

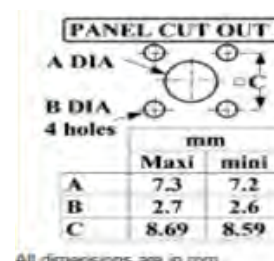

All dimensions are in mm.

PO8

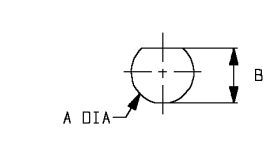

	MM		INCH	
	maxi	mini	maxi	mini
A	8.1	8	0.319	0.315
B	7.6	7.5	0.299	0.295

PO9

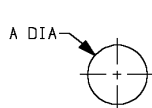

	MM		INCH	
	maxi	mini	maxi	mini
A	5.2	5.16	0.205	0.203

P10

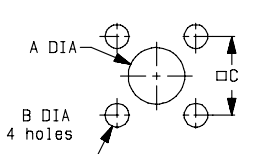

	MM		INCH	
	maxi	mini	maxi	mini
A	4.2	4.1	0.165	0.161
B	2.7	2.6	0.106	0.102
C	8.69	8.59	0.342	0.338

P11

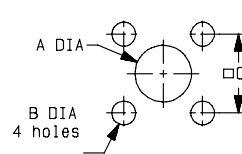

	MM		INCH	
	maxi	mini	maxi	mini
A	4.2	4.1	0.165	0.161
B	1.9	1.8	0.071	0.067
C	6.4	6.3	0.252	0.248

P12

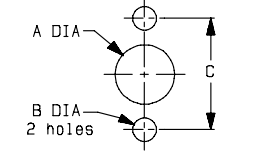

	MM		INCH	
	maxi	mini	maxi	mini
A	4.2	4.1	0.165	0.161
B	2.7	2.6	0.106	0.102
C	12.25	12.15	0.482	0.478

Panel drilling

HERMETIC SEPARATE GLASS BEAD RECEPTACLES

P13/14

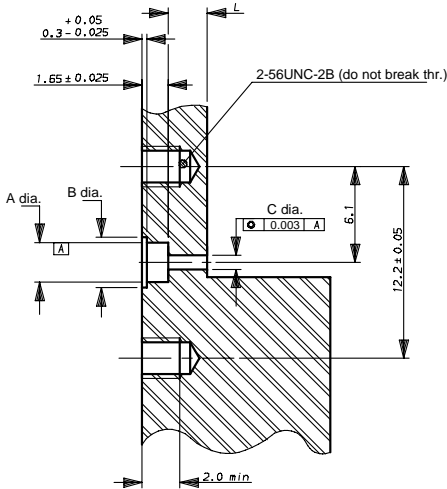

	P13	P14
A dia.	2.6±0.025	2.92±0.025
B dia.	3.23±0.025	3.55±0.025
C dia. (1)	2±0.02	
C dia. (2)	0.7±0.02	1.08±0.02
L dia. (1)	2.5±0.1	
L dia. (2)	from 1 mm to 4 mm	

- (1) Using of the removable contact.
- (2) The pin is directly welded on the trace.

P15/16

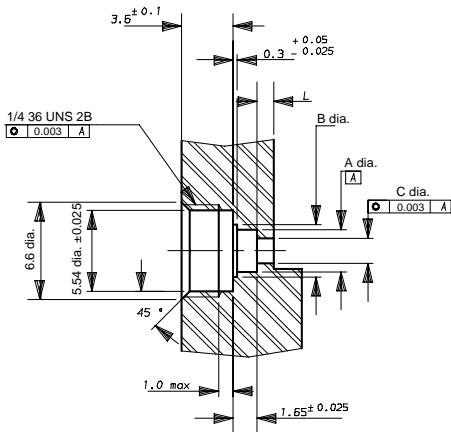

	P15	P16
A dia.	2.6±0.025	2.92±0.025
B dia.	3.23±0.025	3.55±0.025
C dia. (1)	2±0.02	
C dia. (2)	0.7±0.02	1.08±0.02
L dia. (1)	2.5±0.1	
L dia. (2)	from 1 mm to 4 mm	

- (1) Using of the removable contact.
- (2) The pin is directly welded on the trace.

P17

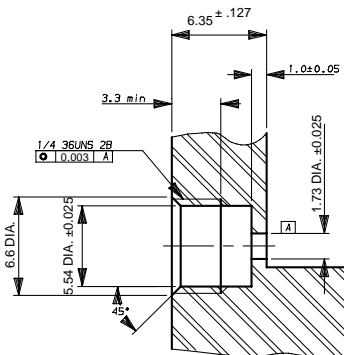

P18

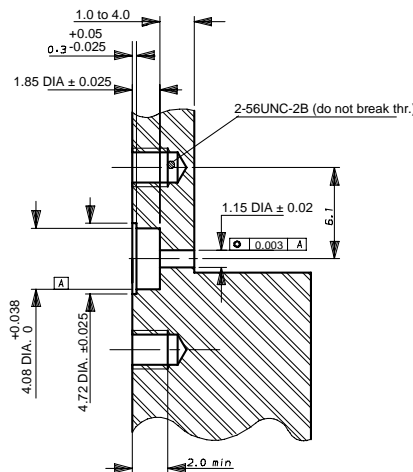

Panel drilling

HERMETIC SEPARATE GLASS BEAD RECEPTACLES

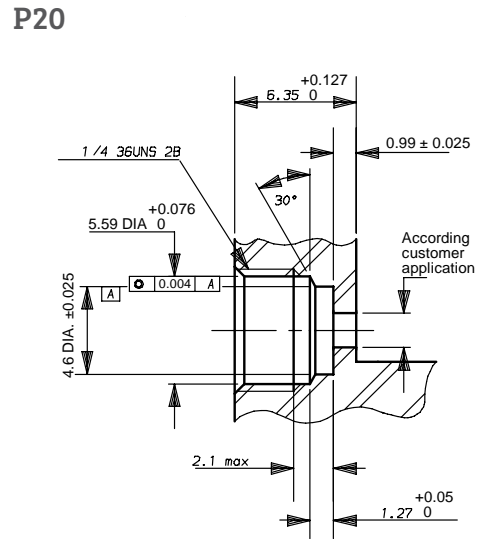
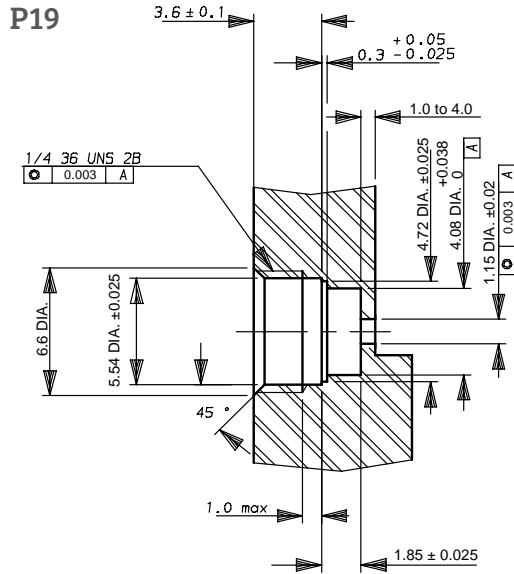

Tooling for hermetic receptacles

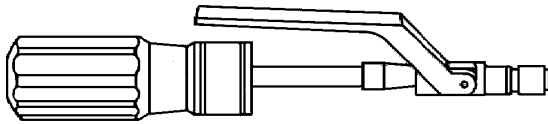

Coupling torque: 190 cm N

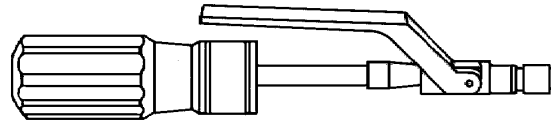

Coupling torque: 280 cm N

Part number	Description
R282 341 010	Installation tool for jack receptacles R125 556 000 R125 556 001 R125 556 010 R125 556 011

Part number	Description
R282 341 012	Installation tool for jack receptacles R125 605 361 R125 605 371 R125 605 401 R125 609 000 R125 609 001 R125 609 010 R125 609 011 R125 609 070 R125 609 071

Field replaceable hermetic microstrip receptacle information

ELECTRICAL PERFORMANCES

V.S.W.R. to 18 GHz

Connector only	Seal only	Connector & seal
1.04 + 0.006F (GHz)	1.02 + 0.003F (GHz)	1.06 + 0.01F (GHz)

V.S.W.R. MEASUREMENT

Setting for V.S.W.R. measurement on field replaceable hermetic receptacle

a) Measurement with auxiliary contact-assembly drawing

- R280 469 000 (for pin DIA 0.30 mm)
- R280 469 010 (for pin DIA 0.46 mm)

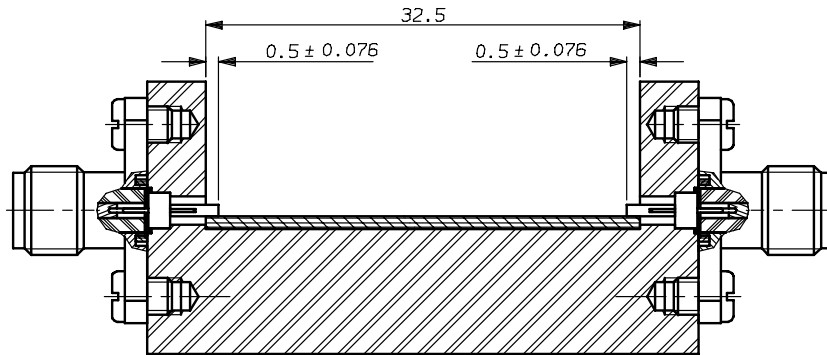

b) Measurement without auxiliary contact-assembly drawing

Recommended value : L1 = 1.0 mm

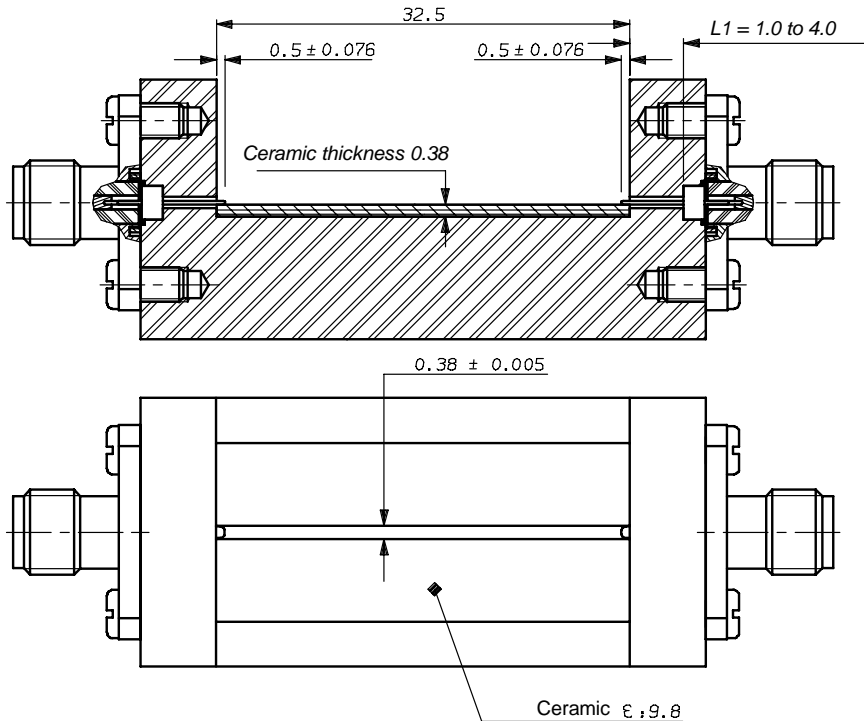

The track width on ceramic defines the circuit impedance.

Field replaceable hermetic microstrip receptacle information

GLASS BEAD AND CONNECTOR ASSEMBLY INTO THE MICRO ELECTRONIC PACKAGE

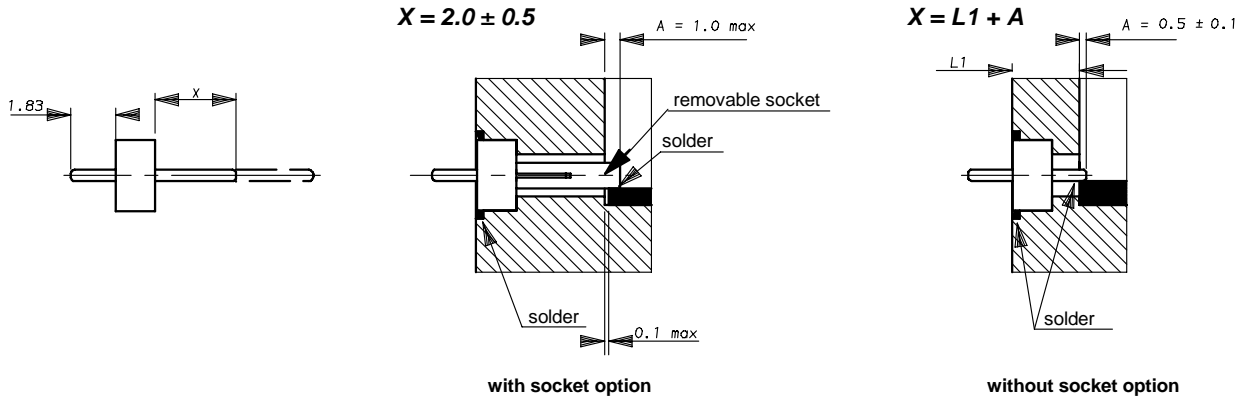

GLASS BEAD

1. Adjust X by cutting the pin if necessary
2. Introduce the glass bead into its cavity
3. Place a ring of solder in the groove around the glass bead (a 0.3 mm wire dia. of solder is recommended)
4. Solder the pin (or optional socket) on the PCB trace inside the package

Note: there is not too much welding.

IMPORTANT: For maximum RF performances, the link track/pin must be as thin as possible.

Therefore, we advise to follow the A dimension rigorously, by soldering accurately the pin or the socket directly on the trace.

CONNECTOR RECEPTACLE

Place the "EMI" screening gasket in the groove of the receptacle (if applicable).

Introduce gently the receptacle on the glass bead pin, then screw the flange (use the appropriated tool for screw-in receptacle).

GLASS BEAD MOUNTING

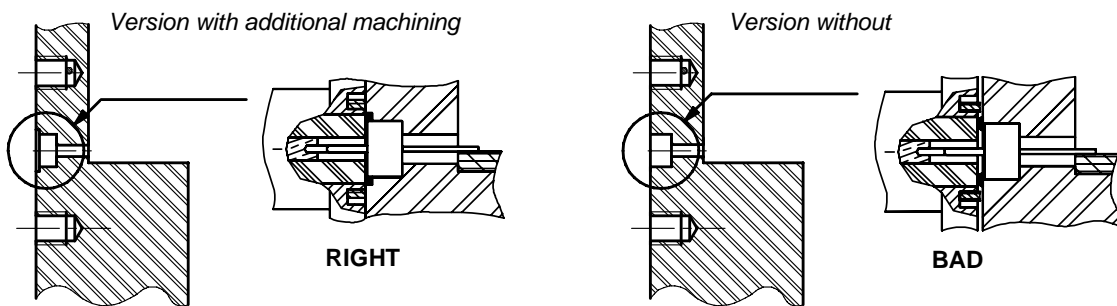

The Radiall panel drilling on page 8-27 recommends an additional bore or chamfer machining on the outer edge of the glass bead housing. This additional machining allows to place a pre-form (solder stick Dia. 0.3 mm) before soldering.

After mounting, solder is flushing and allows the right positioning of the receptacle.

The EMI gasket efficiency is guaranteed.

Introduction

Radiall Commercial SMA connectors are specially designed for applications where low installed costs are of the most importance. They are easy, fast to assemble and reliable, and offer the perfect solution for high volume applications requiring high level performance such as in civil telecommunications, data communications or test and measurement.

- **Full compatibility:**

Commercial SMA connectors are fully compatible (interchangeable and intermateable) with all existing MIL standardized SMA connectors. They feature the same performance level except for mechanical characteristics (life: 100 matings and coupling nut torque: 60 Ncm).

The coupling nut of Commercial SMA connectors features a special design which is different from the standard SMA coupling nut as the tightening torque is reduced.

- **Wide range:**

The Commercial SMA series offers a wide range of solutions which are for every standard coaxial flexible or semi-rigid cable as well as PCB models with traditional through-hole pins or solder pads for SMT applications.

- **Simple snap-in axial captivation (for full crimp models):**

The relative position of the center contact into the interface is mechanically guaranteed by the snapping of the insulator inner shoulder into the groove of the center contact.

This design facilitates the captivation operation in contrast to other designs, requiring two insulators to provide contact retention.

It assures constant and perfect axial positioning of the center contact into the interface.

- **Space-saving size:**

Due to the captivation technique, these commercial SMA connectors are shorter than multi-piece body connectors.

- **Convenient 3-piece design:**

- For straight models: body + center contact + outer ferrule
- For right angle models: single piece body + back cap + outer ferrule

- **Fast and reliable cable attachment:**

The cable connectors can be either fully crimped or soldered/crimped, offering full flexibility for high volume industrial production with standard manual or pneumatic tooling: fast and reliable

- The center contact can be either crimped or soldered
- The outer contact is attached to the cable by crimping a ferrule

- **Competitive pricing:**

The design and materials used in the manufacturing of the Commercial SMA series allow us to offer connectors at competitive prices to suit a wide range of applications. The connector body is manufactured in brass and the surface plating is available in either gold or in BBR finish (Radiall non-magnetic bright bronze surface finish).

- **Center contact captivation:**

Our connectors have a captive center contact.

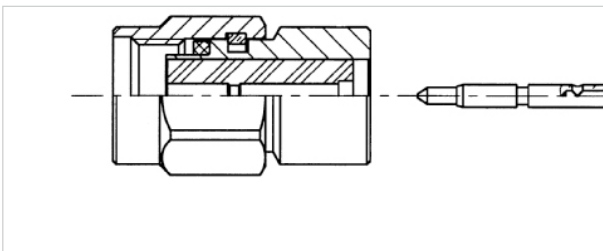

Introduction

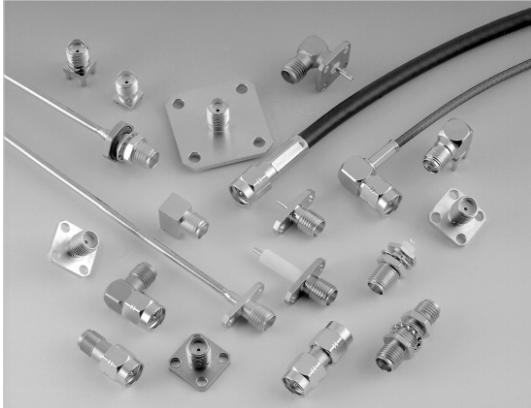

50Ω

DC - 18 GHz

GENERAL

- Subminiature coaxial connectors
- Screw-on coupling
- High RF performance
- 2 plating options:
 - BBR
 - Gold

APPLICABLE STANDARDS

- MIL-C-39012
- IEC 169-1
- CECC 22110
- CECC 22111 - 801 to 808
- BS 9210 N006

APPLICATIONS

- Telecommunications
- Aeronautics
- Measurement and Test systems
- General electronics

Interface

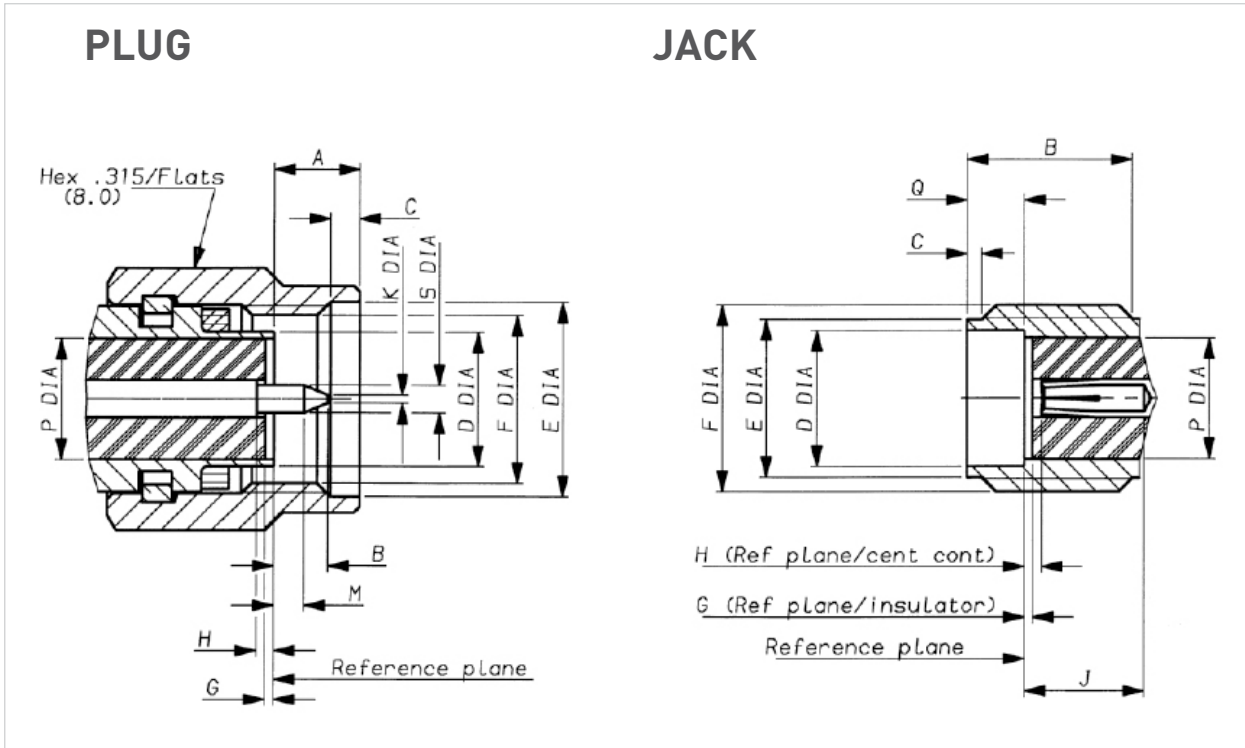

Letter	mm		inch	
	min.	max.	min.	max.
A		3.43		.135
B		2.54		.100
C	0.38	1.14	.015	.045
D DIA		4.59		
E DIA	6.35		.250	
F DIA	1/4 36 UNS 2B			
G*	0.0	-0.20	0.0	-.008
H*	0.0	-0.25	0.0	-.010
J				
K DIA		0.38		.015
M	1.27		.050	
P DIA	4.10 nom.		.161 nom.	
Q DIA				
S DIA	0.90	0.94	.035	.037

Letter	mm		inch	
	min.	max.	min.	max.
A				
B	4.31		.170	
C	0.38	1.14	.015	.045
D DIA	4.596		.181	
E DIA	5.28	5.49	.208	.216
F DIA	1/4 36 UNS 2A			
G*	0.0	-0.20	0.0	-.008
H*	0.0	-0.25	0.0	-.010
J	2.92		.115	
K				
M				
P DIA	4.10 nom.		.161 nom.	
Q	1.88	1.98	.074	.078
S DIA				

*Note:
Means behind ref plane

Characteristics

Test / Characteristics	MIL-C-39012 paragraph	Values / Remarks
------------------------	-----------------------	------------------

GENERAL

Impedance		50Ω	
Frequency range		Semi-rigid cables	Standard models
		DC - 18 GHz	DC - 12.4 GHz
Temperature range		- 65°C + 105°C	- 65°C + 165°C

ELECTRICAL CHARACTERISTICS

Insulation resistance	3-11	5000 MΩ mini.			
Contact resistance • Outer conductor • Inner conductor	3-16	Initial		After test	
		3 mΩ 2 mΩ		4 mΩ 3 mΩ	
V.S.W.R. max up to: 18 GHz for semi-rigid cable 12.4 GHz for right angle connector (SR) 12.4 GHz for flexible cable • Straight Connector • Right angle connector	3-14	.085"	.141"	2.6/50/S	5/50/D
		1.07 + .01F 1.10 + .01F	1.05 + .01F 1.10 + .01F	1.15 + .02F 1.15 + .03F	1.15 + .01F 1.15 + .02F
Dielectric withstanding voltage in VRMS	3-17	750	1000	750	1000
Working voltage in VRMS (sea level)		335	500	250	335
Working voltage in VRMS (70 000 ft)		85	125	65	85
RF testing voltage at 5 MHz in VRMS	3-23	500	670	500	670

MECHANICAL CHARACTERISTICS

Cable retention force	3-24	.085"	.141"	2.6/50/S	5/50/D
		130 N	270 N	90 N	204 N
Life	3-15	100 matings			
Force to engage and disengage	3-5-1	23 Ncm - 2 inch pounds			
Coupling nut torque recommended		60 Ncm - 5.2 inch pounds			
Coupling nut retention force	3-25	272 N min			

ENVIRONMENTAL CHARACTERISTICS

Vibration	3-18	MIL STD 202, method 204, condition D,20g
Shock	3-19	MIL STD 202, method 213, condition 1,100g
Thermal shock	3-20	MIL STD 202, method 107, condition B,
Corrosion (salt spray)	3-13	MIL STD 202, method 101, condition B,
Moisture resistance	3-21	MIL STD 202, method 106
Barometric pressure	3-22	MIL STD 202, method 105, condition C
Hermetic test		Down to 10 ⁻⁶ mmHg (Torr) leakage rate < 10 ⁻⁸ atm/cm ³ /sec
Life (at high temperature)		MIL STD 202, method 108

MATERIALS AND PLATING

	Material	Plating
Bodies	Brass	BBR* or Gold plated
Center contacts	Beryllium copper (female) Brass (male)	Gold plated
Insulators	PTFE teflon	
Gaskets	Silicone rubber	

*BBR: Bright Bronze Radiall

All dimensions are given in mm.

Standard packaging: 100 pieces

Plugs

STRAIGHT PLUGS, FULL CRIMP TYPE FOR FLEXIBLE CABLE

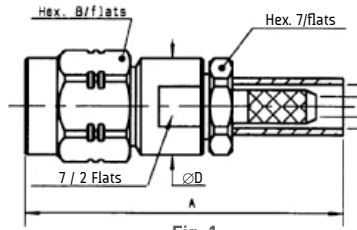

Fig. 1

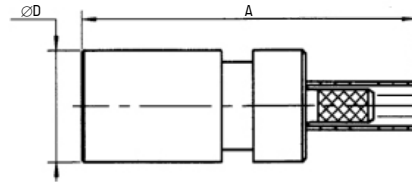

Fig. 2

Cable group	Cable group dia.	Part number (Gold)	Part number (BBR)	Fig.	Dimensions (mm)		Captive center contact	Note	
					A	D			
RG178 / RG196	2/50/S	R124 069 123	R124 069 120	1	25	7.7	yes	Back nut / Solder contact	
RG174 / RG316	2.6/50/S	R124 071 123	R124 071 120	2	23.4				
RD316	2.6/50/D		R124 072 220		26.4				
RG58 / RG141	5/50/S	R124 075 323	R124 075 320	1	26.3				
RG142 / RG223 / RG400	5/50/D	R124 076 323	R124 076 320		27.15			7	
AEP-195FR	LMR® 195		R124 075 210		29.15	7			
AEP-200FR	LMR® 200		R124 076 450	1	33.59	12.7		Crimp type	
AEP-240FR	LMR® 240		R124 076 430						
AEP-400FR	LMR® 400		R124 080 030						

STRAIGHT PLUGS, SOLDER TYPE FOR SEMI-RIGID CABLE

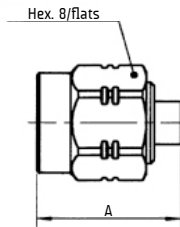

Fig. 1

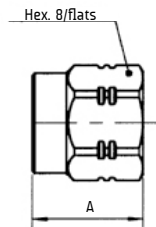

Fig. 2

Cable group	Cable group dia.	Part number (Gold)	Fig.	Dimensions A (mm)	Captive center contact
RG405	.085"	R124 052 013	1	11.1	no
RG402	.141"	R124 054 003	2	8.5	yes
		R124 055 003	1	11.2	no

Plugs and jacks

RIGHT ANGLE PLUGS

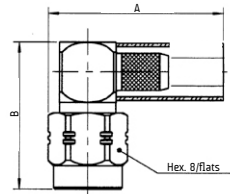

Fig. 1

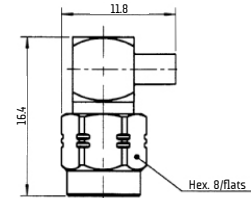

Fig. 2

Cable group	Cable group dia.	Part number (Gold)	Part number (BBR)	Fig.	Dimensions (mm)		Note
					A	B	
RG174 / RG316 / AEP-100FR	2.6/50/S & LMR® 100	R124 172 123	R124 172 120	1	18	16.35	Crimp type for flexible cable
RD316	2.6/50/D	R124 174 123	R124 174 120				
RG58 / RG141	5/50/S	R124 175 123	R124 175 120				
RG142 / RG223 / RG400	5/50/D	R124 176 123	R124 176 120				
AEP-195FR	LMR® 195		R124 175 110	2	16.29	19.67	Crimp type
AEP-200FR	LMR® 200		R124 175 200			16.3	
AEP-240FR	LMR® 240		R124 175 310				
RG405	.085"	R124 153 003	R124 153 001				
RG402	.141"	R124 154 001	R124 154 001				

STRAIGHT JACKS

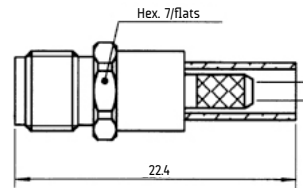

Fig. 1

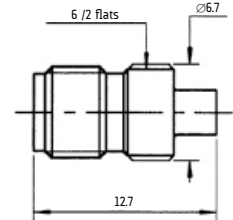
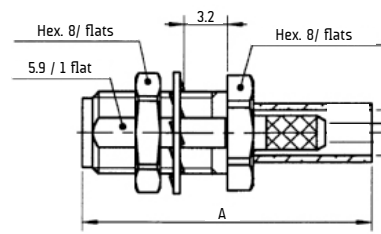
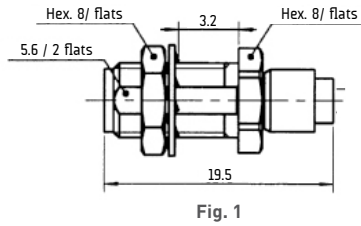

Fig. 2

Cable group	Cable group dia.	Part number (Gold)	Fig.	Captive center contact	Note
RD316	2.6/50/D	R124 233 123	1	yes	Full crimp type for flexible cable
RG174 / RG316	2.6/50/S	R124 236 123			
RG405	.085"	R124 222 003	2	no	Solder type for semi-rigid cable

Jacks

BULKHEAD FEEDTHROUGH STRAIGHT JACKS, FULL CRIMP TYPE, FOR FLEXIBLE CABLE



Cable group	Cable group dia.	Part number (Gold)	Part number (BBR)	Fig.	Dimensions A (mm)	Panel drilling	Captive center contact	Note
RG178 / RG196	2/50/S	R124 310 023		1		P06		Reverse crimping / Solder contact
RG174 / RG316 / AEP-100FR	2.6/50/S & LMR® 100	R124 312 123	R124 312 120	2	22.4	P05	yes	
RG 58 / RG141	5/50S		R124 314 120		25.4			
RG142 / RG223 / RG400	5/50/D		R124 315 120					Full crimp type

BULKHEAD FEEDTHROUGH STRAIGHT JACKS, SOLDER TYPE, FOR SEMI-RIGID CABLE - PANEL SEAL

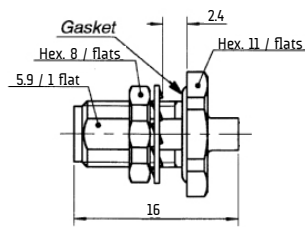

Cable group	Cable group dia.	Part number (Gold)	Panel drilling	Captive center contact
RG405	.085"	R124 326 003	P05	no
RG402	.141"	R124 325 003		

FLANGE JACKS, SOLDER TYPE FOR SEMI-RIGID CABLE

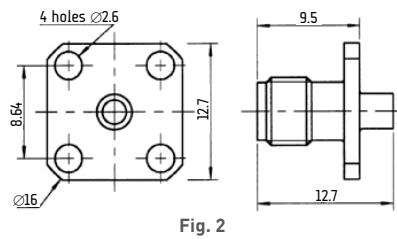
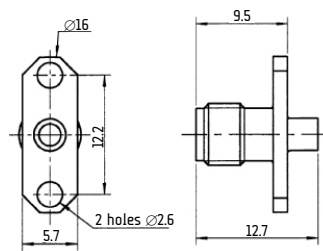

Cable group	Cable group dia.	Part number (Gold)	Fig.	Panel drilling	Captive center contact
RG405	.085"	R124 252 003	1	P04	no
		R124 256 003	2	P02	
RG402	.141"	R124 255 003			

Receptacles

SQUARE FLANGE FEMALE RECEPTACLES

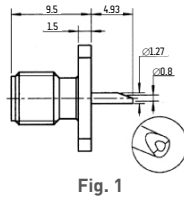
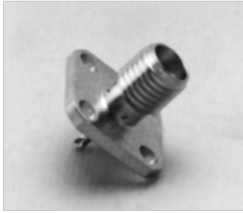

Fig. 1

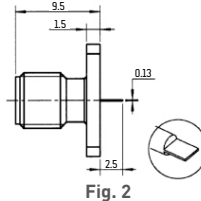

Fig. 2

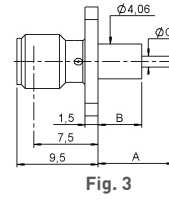

Fig. 3

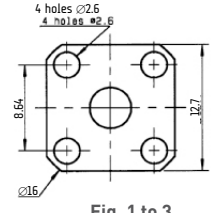

Fig. 1 to 3

Part number	Fig.	Dimensions (mm)			Panel drilling	Finish	Captive center contact
		A	B	C			
R124 403 123	1				P01	Gold	yes (4 indents)
R124 413 025	3	8.9	5.1	1.28			
R124 415 273		17.9	15	1.27			
R124 510 000	2				BBR		

NARROW FLANGE FEMALE RECEPTACLES

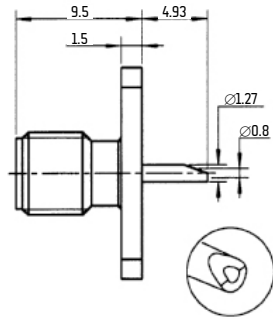

Fig. 1

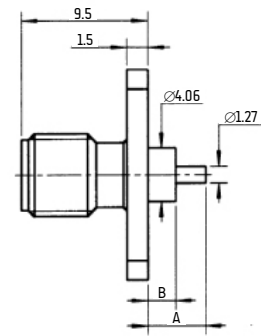
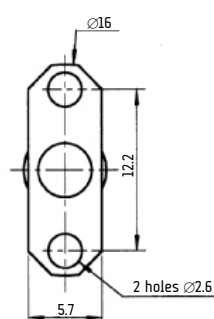
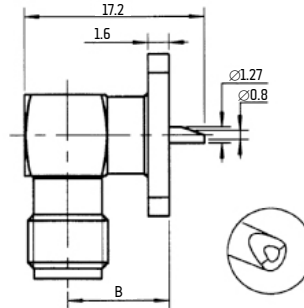
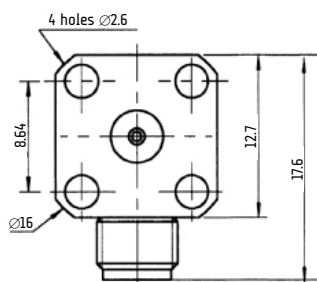

Fig. 2

Part number	Fig.	Dimensions (mm)		Panel drilling	Finish	Captive center contact
		A	B			
R124 454 123	1			P04	Gold	yes (4 indents)
R124 464 000	2	15.9	12.7		BBR	

RIGHT ANGLE SQUARE FLANGE FEMALE RECEPTACLES



Part number	Panel drilling	Finish
R124 654 003	P02	Gold

Switches

STRAIGHT FEMALE PCB RECEPTACLES AND SWITCHES

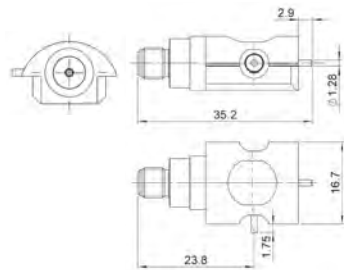

Fig. 1

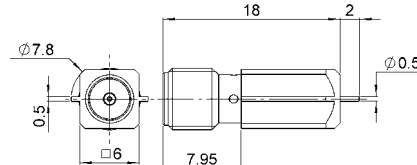

Fig. 2

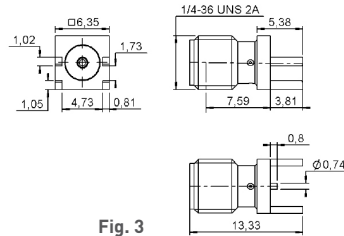

Fig. 3

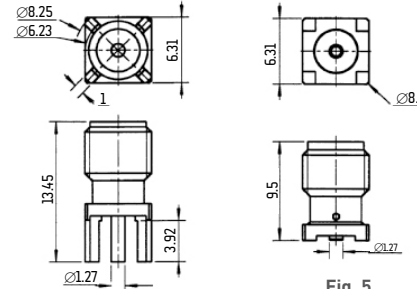

Fig. 4

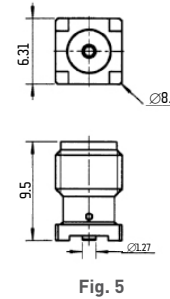

Fig. 5

Part number	Fig.	Panel drilling	Assembly instructions	Finish	Note
R124 422 001	1		M03		Switch edge card SMT - Right type - packaging in Reel 110 pieces
R124 423 033	2		M02	Gold	SMT edge card type - packaging: unit
R124 423 223	3				
R124 426 120	4	P03		BBR	
R124 426 123					
R124 427 000	5		M01	Gold	Surface mount / Bulkhead 100 pieces
R124 427 800					Surface mount / Tape & Reel 100 pieces

RIGHT ANGLE FEMALE PCB RECEPTACLES

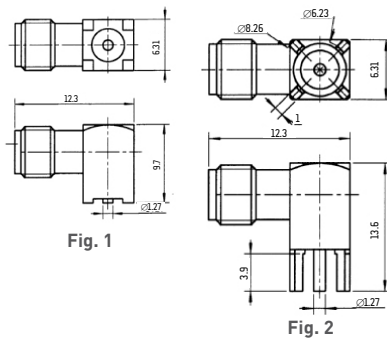

Fig. 1

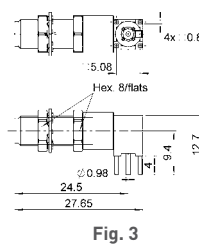

Fig. 3

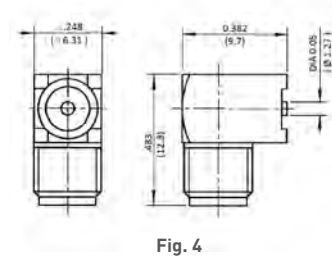
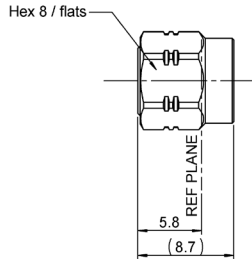

Fig. 4

Part number	Fig.	Panel drilling	Assembly instructions	Finish	Note
R124 667 143	3	P07		Gold	Packaging: tray 60 pieces
R124 680 120	2	P03		BBR	
R124 680 123					
R124 681 000	1		M01	Gold	Surface mount / Bulkhead 100 pieces
R124 681 800	4		M04		Packaging: Tape & Reel 100 pieces

Receptacles

MALE CAP



Part number	Finish	Note
R124 802 108	Tin	No chain

ADAPTERS

For in series adapters, please see standard SMA.

Panel drilling

P01

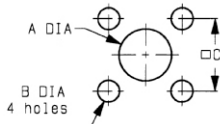

	MM		INCH	
	maxi	mini	maxi	mini
A	4.2	4.1	0.165	0.161
B	2.7	2.6	0.106	0.102
C	8.69	8.59	0.342	0.338

P02

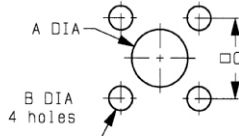

	MM		INCH	
	maxi	mini	maxi	mini
A	6.6	6.5	0.26	0.256
B	2.7	2.6	0.106	0.102
C	8.69	8.59	0.342	0.338

P03

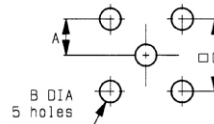

	MM		INCH	
	maxi	mini	maxi	mini
A	2.59	2.49	0.102	0.098
B	1.7	1.6	0.067	0.063
C	5.13	5.03	0.202	0.198

P04

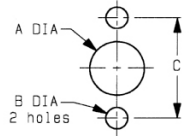

	MM		INCH	
	maxi	mini	maxi	mini
A	4.2	4.1	0.165	0.161
B	2.7	2.6	0.106	0.102
C	12.25	12.15	0.482	0.478

P05

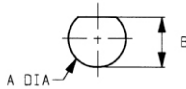

	MM		INCH	
	maxi	mini	maxi	mini
A	6.5	6.4	0.256	0.252
B	6.15	6	0.242	0.238

P06

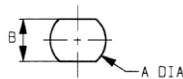

	MM		INCH	
	maxi	mini	maxi	mini
A	6.5	6.4	0.256	0.252
B	5.8	5.7	0.228	0.224

P07



	mm	
	Maxi	mini
A	6.40	6.35

Assembly instructions

M01

Part number	
R124 427 000 R124 427 800	R124 681 000

SOLDERING PATTERN

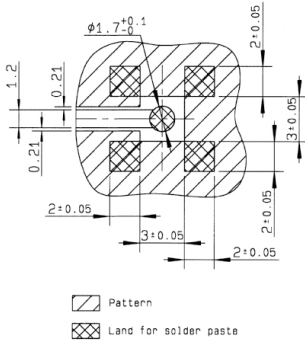

COPLANAR LINE

- Pattern and signal are on the same side
- Thickness of PCB: 1.6 mm
- The PCB material is made of epoxy resin of glass fabrics bacs (Er = 4.8)
- The solder resist should be printed except for the land pattern on the PCB

ASPIRATION PORT

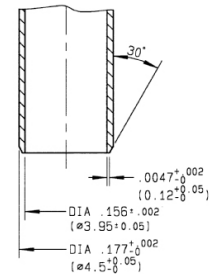

VIDEO SHADOWS

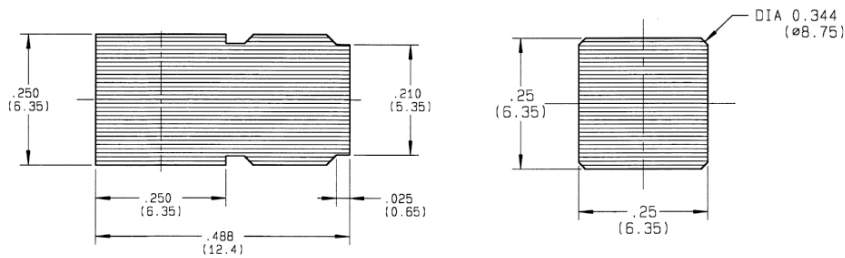

M02

SOLDERING PATTERN

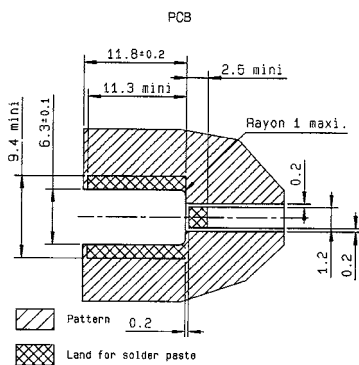

Part number
R124 423 033

COPLANAR LINE

- Pattern and signal are on the same side
- Thickness of PCB: .063 (1.6 mm)
- The PCB material is made of epoxy resin of glass fabrics bacs. (Er = 4.8)
- The solder resist should be printed except for the land pattern on the PCB

ASPIRATION PORT

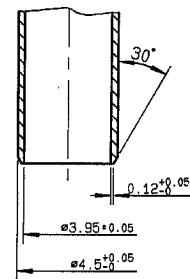

VIDEO SHADOW

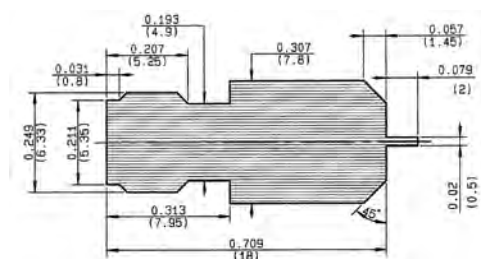

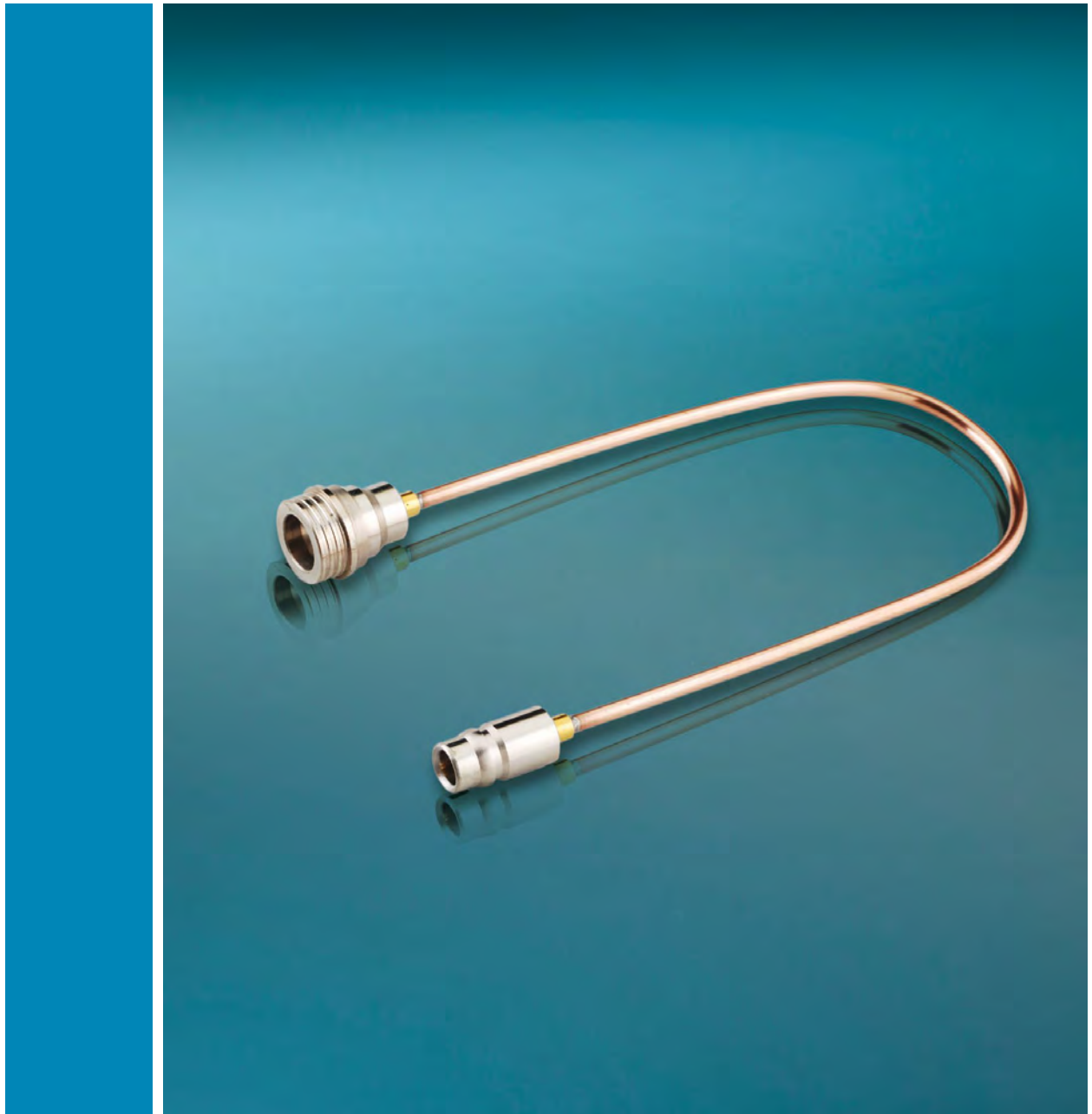

Quick-Lock: QMA / WQMA / QN / QRE™
R123 / R123W / R164 / R324



Contents

QMA and WQMA

Introduction 8-4 to 8-5
Characteristics 8-6 to 8-7
QMA plugs and jacks 8-8 to 8-9
QMA receptacles 8-9 to 8-10
QMA accessories and adapters 8-11 to 8-12
QMA panel drilling and assembly instructions 8-12 to 8-13
WQMA plugs, jacks and receptacles 8-14

QN

Introduction 8-4 to 8-5
Characteristics 8-15 to 8-16
Plugs and jacks 8-16 to 8-18
Receptacles 8-18 to 8-19
Adapters 8-19
Protective cap 8-20
Panel drilling 8-20

QRE™

Introduction 8-21
Characteristics 8-21
Plugs, jacks and receptacles 8-22
Adapters 8-23
Panel drilling 8-23

Introduction

The "Quick-Lock Formula™": Your cost saving solution

Radiall's patented QMA and QN connectors are now the standard for the RF telecommunications industry. The "QLF" registered trademark, Quick-Lock Formula™ standard, applies to the QMA and QN series and guarantees the full intermateability between suppliers using this trademark. Using QLF™ certified connectors also guarantees the highest RF transmission performance.



QMA (Quick-Lock SMA) and QN connectors (Quick-Lock N) enable fast, secured, and easy matings with minimum space requirements. The QMA and QN series are the perfect alternative to SMA and N connectors in new generation telecommunication systems as well as in many other RF applications.

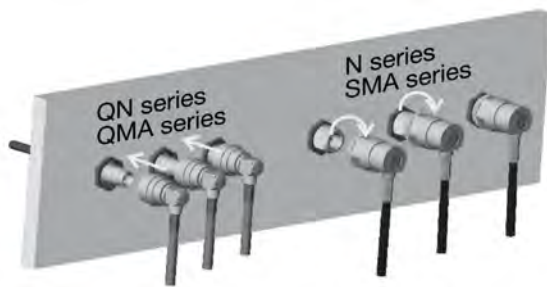

Saving installation time: Ten times faster

QMA and QN connectors are ten times faster to connect compared to N or SMA connectors, reducing the cost of ownership. With their snap-on interface, it takes only two seconds to connect QN and SMA connectors in field conditions.

Secure connection: Click!

The snap-on connection is insured by a chamfer. In addition, a positive locking system ensures an excellent and secure connection. The disengagement force is lower than the panel tear-off force, preventing any panel damage. QN and QMA connectors have been successfully tested against vibration.

Flexibility: 360° rotation

The cabled plug can freely rotate around the jack, which allows for more flexibility during the mounting process and eases the installation within the equipment.



In addition, it prevents from any added stress on the cable and return loss reduction due to cable bending. As no torque wrench is required, the risk in damaging or scratching the panel is eliminated.

Introduction

Space saving

QN and QMA connectors have a lower space requirement since space for the use of a torque wrench is not necessary. Therefore the distance between connectors is optimized on the panel.

QMA Series

The QMA series with Quick-Lock Formula™, is the innovative patented snap-on generation of brass SMA connectors. With the same interface dimensions, QMA connectors have the identical high electrical performances as the SMA series with an easier and faster mounting design. The QMA series is a cost effective solution for the new generation of base stations. The QMA series is designed for DC to 18 GHz. This series features 100 matings and total reliability as the standard commercial SMA connectors. They are fast and easy to connect and disconnect. The new QMA series offers a large range of connectors: straight and right angle plugs, bulkhead jacks, flange receptacles, PCB receptacles, adapters and more. Models are either full crimp, crimp or solder type for flexible, semi-rigid or conformable cables.

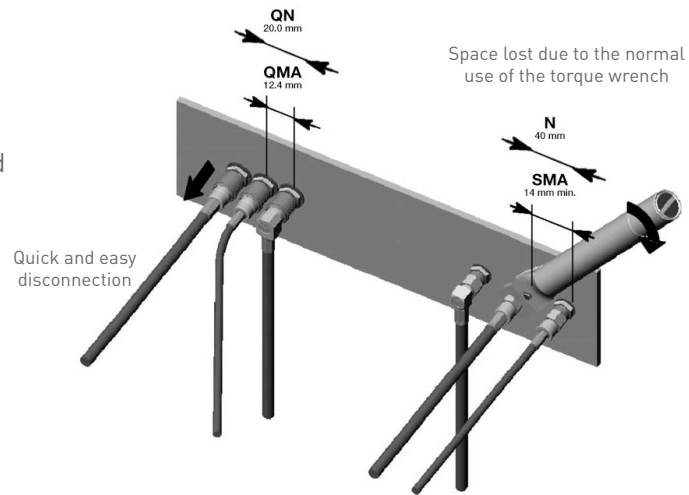

WATERPROOF QMA Series

Radiall expands its QMA product line with new high density RF coaxial **Waterproof QMA (WQMA)** connector solutions with fast and easy snap-on Quick Lock technology. WQMA connectors offer outstanding electrical performance and have environmental characteristics that provide for long lasting durability needed for the most demanding harsh outdoor applications, thus eliminating the need for costly and bulky watertight enclosures or cable entries.

Waterproof QMA CONNECTORS are fully intermateable and backward compatible with any QLF™ certified standard QMA connectors and they provide for excellent ingress protection.

- IP 68 rating when mated
- 100 matings minimum for durability
- Wide temperature range -40°C / +105°C
- Power rating 200W @ 1 GHz, 75°C

QN Series

Offering the same operating frequency range between DC and 11 GHz as the N series, the new QN series performance has been **optimized from DC to 6 GHz for 50Ω applications**. The new QN interface typically features a VSWR of 1.05 from DC to 3 GHz and 1.12 from 3 to 6 GHz. The corresponding return loss is **32 dB from DC to 3 GHz and 25 dB from 3 to 6 GHz**. The high screening effectiveness enables a level of RF leakage as low as -90 dB from DC to 3 GHz and -80 dB from 3 to 6 GHz.

Designed for indoor and outdoor applications such as BTS, antenna systems or test and measurement devices, QN connectors offer an outstanding intermodulation level (-155 dBC / -112 dBm) and IP rating (water and dust protection). The power rating is **300 W at 2.5 GHz** and features **100 matings**.

Characteristics QMA

Test / Characteristics	Values / Remarks
ELECTRICAL CHARACTERISTICS	
Impedance	50Ω
Frequency range	DC - 6 GHz (optimized) DC - 18 GHz (working range)
Typical V.S.W.R. • DC - 3 GHz • 3 GHz - 6 GHz	1.06 1.12
Max insertion loss	0.25 dB
Insulation resistance	5000 MΩ
Voltage rating	≤ 500 V RMS 50 Hz, sea level
Dielectric withstanding voltage	1500 V RMS 50 Hz, sea level
Contact resistance • Center contact • Outer contact	< 3 mΩ < 2.5 mΩ
Admissible power @ 2.5 GHz (continuous power)	125 W @ T = 40°C (150 W @ T = 23°C)
Passive Intermodulation	-120 dBc @ 1.8 GHz (2x20W) (static)
RF leakage • DC - 3 GHz • 3 - 6 GHz	-80 dB min -70 dB min

MECHANICAL CHARACTERISTICS

Mechanical endurance	100 matings
Engagement and disengagement force • Engagement • Disengagement	25 N 20 N
Retention force for interface	> 60 N
Cable retention force 2.6 / 50 S 2.6 / 50 D 5 / 50 S 5 / 50 D 5.7 / 50 D	90 N 110 N 180 N 200 N 220 N
Distance between connectors: c. to c.	12.4 mm min.
Vibration	40 m.s ⁻² at 500 Hz

ENVIRONMENTAL CHARACTERISTICS

Temperature range	-40 °C, +105 °C
-------------------	-----------------

MATERIALS

Connector bodies	Brass
Male center contact	Brass
Female center contact	Beryllium copper
Outer contact	Bronze
Other metallic parts	Brass
Insulators	PTFE

PLATING

Bodies	BBR
Solder bodies	BBR
SMT Bodies	NPGR
Outer contacts	BBR
Center contacts	NPGR

All dimensions are given in mm.

Characteristics QMA

POWER RANGE

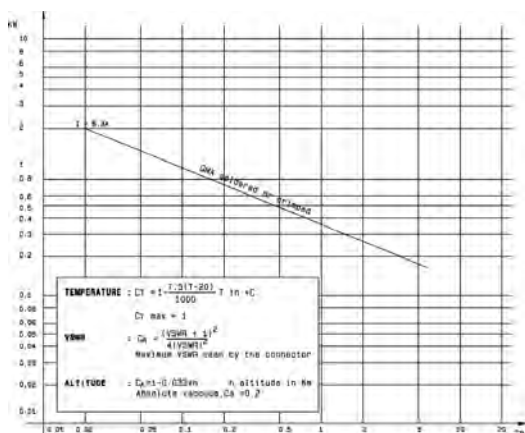

Characteristics WQMA

Test / Characteristics	Values / Remarks
ELECTRICAL AND MECHANICAL CHARACTERISTICS	
Impedance	50Ω
Frequency	DC - 6 GHz
V.S.W.R.	1.02 + 0.0200*F (GHz) Max
Center contact captivation	Yes
Working temperature range	- 40°C / + 105°C
Mating cycles	100

MATERIALS AND PLATING

	Materials	Platings
Connector body	Brass	BBR / NPGR / Gold over Copper
Male center contact	Brass	NPGR
Female center contact	Beryllium copper	NPGR / Gold over Copper
Outer contact and other metallic parts	Brass	BBR
Gasket	Silicone	
Insulator	PTFE	

ENVIRONMENTAL CHARACTERISTICS

Waterproofing	IP68	In mated condition
---------------	------	--------------------

QMA plugs

STRAIGHT PLUGS

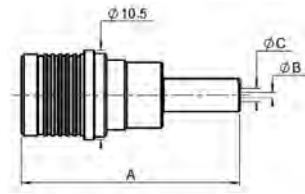

Fig. 1

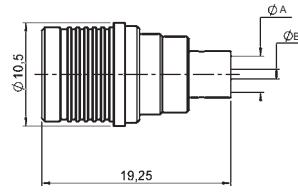

Fig. 2

Cable group	Cable group dia.	Part number	Fig.	Dimensions (mm)			Captive center contact	Finish	Packaging	Note				
				A	B	C								
RG174 / RG316 / AEP-100FR	2.6/50/S & LMR® 100	R123 071 000	1	25.5	0.6	1.61	yes	BBR	100 pieces	Crimp type				
RD316	2.6/50/D	R123 072 000		25.5	0.6	1.61								
RG58 / RG141	5/50/S	R123 075 000		28.5	1.05	3.11								
RG142 / RG223 / RG400	5/50/D	R123 076 000	2	28.5	1.05	3.11			yes	BBR	100 pieces	Solder type		
RG405	.085"	R123 054 000		2.275	0.6									
RG402	.141"	R123 055 000		3.675	1									
AEP-195FR	LMR® 195	R123 075 200	1	28.5	1.05	3.11					yes	BBR	100 pieces	Crimp type
AEP-200FR	LMR® 200	R123 096 110		28.5	1.18	3.25								
AEP-240FR	LMR® 240	R123 076 310		30.5	1.5	4.05								

Plugs

RIGHT ANGLE PLUGS

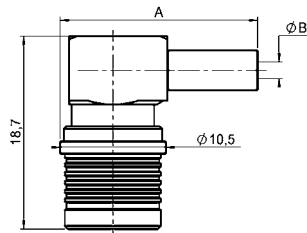

Fig. 1

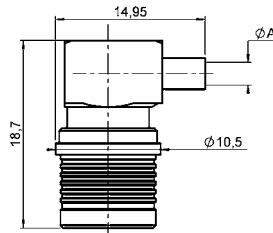

Fig. 2

A right angle plug for 5.7 mm dia. cable is also available, please consulte us.

Cable group	Cable group dia.	Part number	Fig.	Dimensions (mm)		Captive center contact	Finish	Packaging	Note				
				A	B								
RG174 / RG316	2.6/50/S	R123 172 000	1	19.7	0.6	yes	BBR	100 pieces	Crimp type				
RD316	2.6/50/D	R123 174 000		19.7	0.6								
RG58 / RG141	5/50/S	R123 175 000		22.7	3.1								
RG142 / RG223 / RG400	5/50/D	R123 176 000		22.7	3.1								
AEP-240FR	LMR® 240	R123 177 100	2	22.65	4.05			yes	BBR	100 pieces	Crimp type		
RG405	.085"	R123 153 000		2.25								Gold	Solder type
		R123 153 003		2.25								BBR	
RG402	.141"	R123 154 000		3.7								Gold	
		R123 154 003	3.7										

Jacks and receptacles

STRAIGHT BULKHEAD JACKS

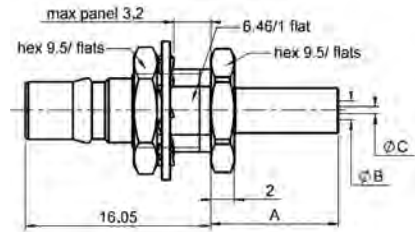

Fig. 1

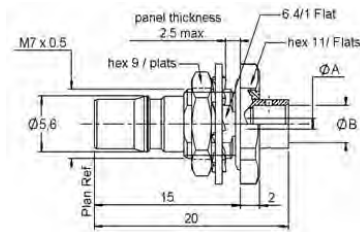

Fig. 2

Cable group	Cable group dia.	Part number	Fig.	Dimensions (mm)			Captive center contact	Panel drilling	Finish	Packaging	Note
				A	B	C					
RG174 / RG316	2.6/50/S	R123 312 000	1	11	0.6	1.61	yes	P02	BBR	100 pieces	Full crimp type
RD316	2.6/50/D	R123 313 000		11	0.6	1.61					
RG58 / RG141	5/50/S	R123 314 000		14	1.05	3.11					
RG142 / RG223 / RG400	5/50/D	R123 315 000		14	1.05	3.11					
AEP-240FR	LMR® 240	R123 314 010	2	0.6	2.25			P02	Gold		Crimp type
RG405	.085"	R123 326 003		1	3.7						Solder type panel seal
RG402	.141"	R123 305 023									

STRAIGHT FLANGE FEMALE RECEPTACLES

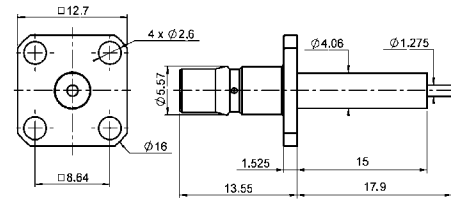

Fig. 1

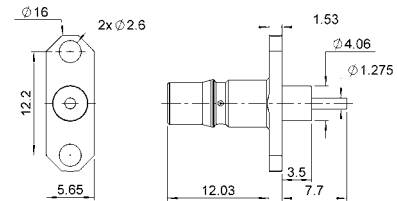

Fig. 2

Part number	Fig.	Captive center contact	Dimensions (mm)		Panel drilling	Finish	Note
			A	B			
R123 415 000	1	yes	15	17.9	P01	BBR	Straight flange
R123 425 100			10	13			Straight flange Panel seal
R123 464 110	2				P04		Straight flange

RECEPTACLES

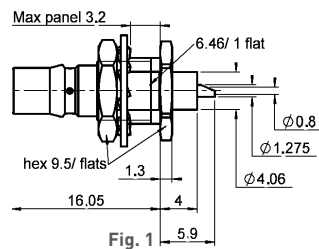

Fig. 1

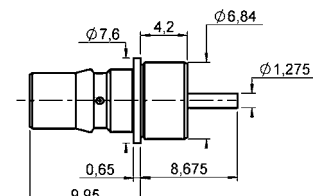
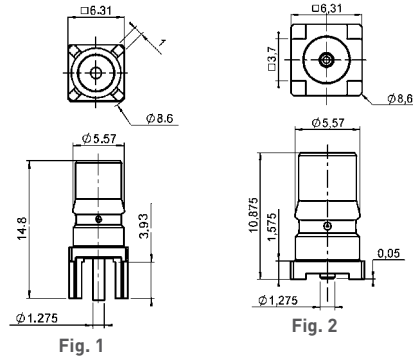

Fig. 2

Part number	Fig.	Captive center contact	Panel drilling	Finish	Note
R123 553 000	1	yes	P02	BBR	Bulkhead receptacle
R123 590 027	2		P05	NPGR	Press mount

Receptacles

STRAIGHT PCB RECEPTACLES



Part number	Fig.	Captive center contact	Finish	Assembly instructions	Panel drilling	Packaging	Note
R123 426 003	1				P03	100/bulk	
R123 427 803	2	yes	NPGR	M01		100/reel	SMT

PCB RECEPTACLES

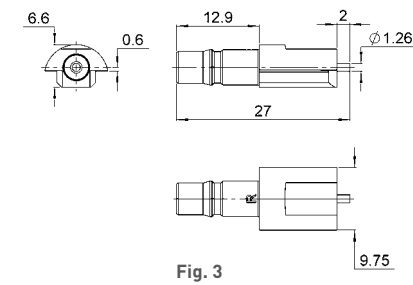
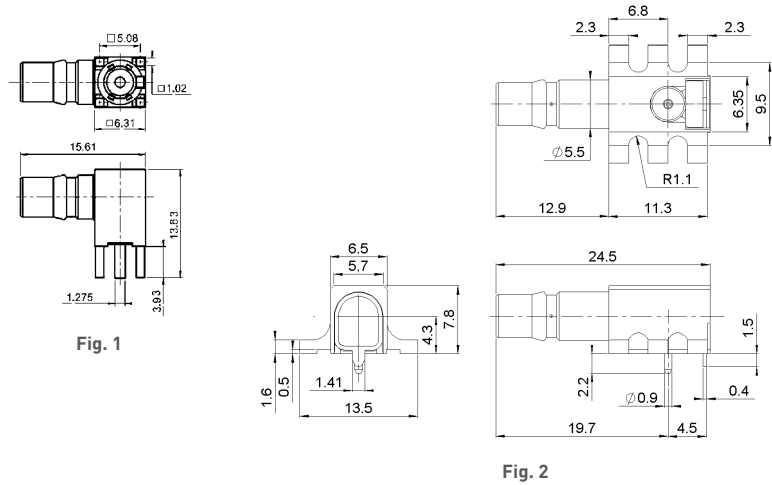

Part number	Fig.	Captive center contact	Finish	Assembly instructions	Panel drilling	Packaging	Note
R123 680 003	1				P03	100/bulk	
R123 682 827	2	yes	NPGR	M01		100/reel	Right angle SMT
R123 682 880	250/reel						
R123 444 827	3					300/reel	Female edge card

Receptacles

RACK AND PANEL

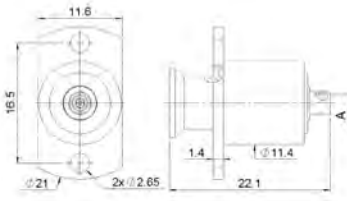

Cable group	Cable group dia.	Part number	Dimensions (mm)	Radial Misalignment	Axial Working Range	Finish	Packaging
			A				
KS1 / RG405	.085 cable	R123 142 000	2.25	Min 1	2.5/4.6	BBR/NPGR	100
KS2 / RG402	.141 cable	R123 141 000	3.65				

Accessories and adapters

MALE CAPS WITH CORD

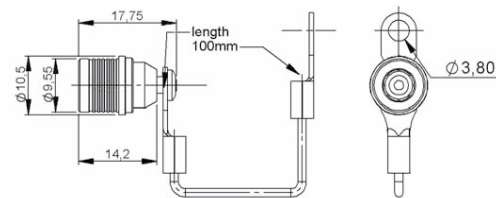

Part number	Finish	Packaging
R123 805 000	BBR	100

IN SERIES ADAPTERS

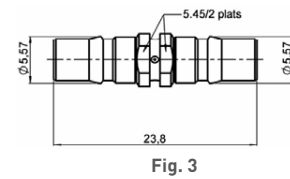
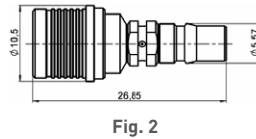
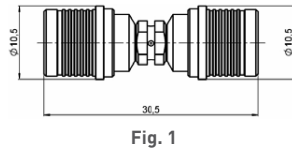

Part number	Fig.	Captive center contact	Finish	Note	Packaging
R123 703 000	1	yes	BBR	QMA male - QMA male	100 pieces
R123 704 000	2			QMA female - QMA male	
R123 705 000	3			QMA female - QMA female	

BETWEEN SERIES ADAPTERS QMA/SMA

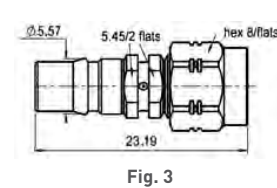
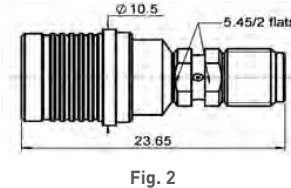
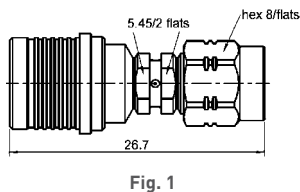

Part number	Fig.	Captive center contact	Finish	Note	Packaging
R191 910 000	1	yes	BBR	QMA male - SMA male	Unit
R191 911 000	2			QMA male - SMA female	
R191 912 000	3			QMA female - SMA male	
R191 913 000	4			QMA female - SMA female	

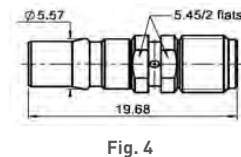

Adapters

BETWEEN SERIES ADAPTERS QMA / N

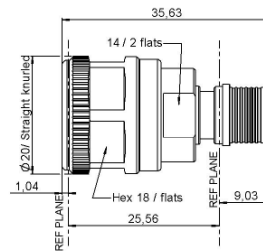
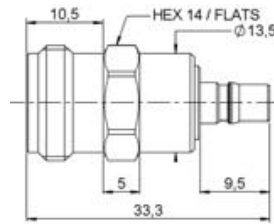
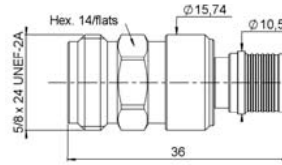
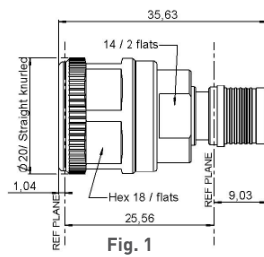

Part number	Fig.	Finish	Note	Packaging
R191 762 000	1	BBR	QMA female - N male	1 Unit
R191 763 000	2		QMA male - N female	
R191 764 000	3		QMA female - N female	
R191 765 000	4		QMA male - N male	

Panel drilling

P01

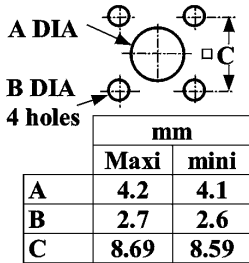

P02

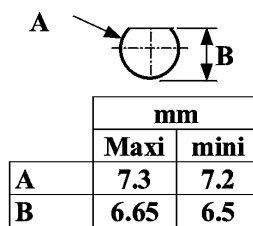

P03

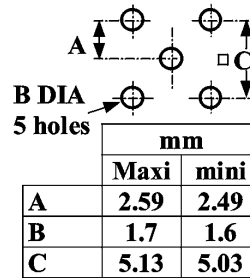

P04

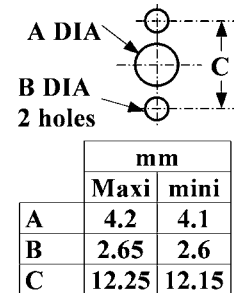

P05

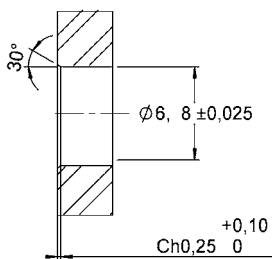

QMA receptacles packaging

TAPE AND REEL

ACCORDING TO IEC
286-3 STANDARD

MATERIALS

Reel: polyester

Carrier tape: antistatic PETG (polyester)

Cover tape: polyester

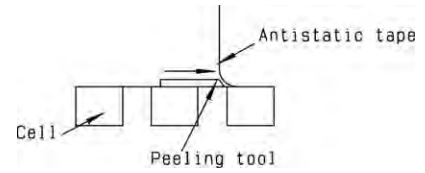
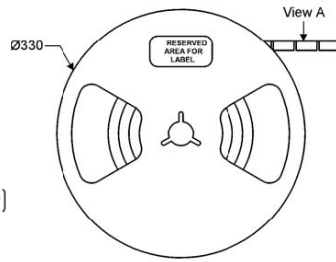

View A

Part number
R123 427 803

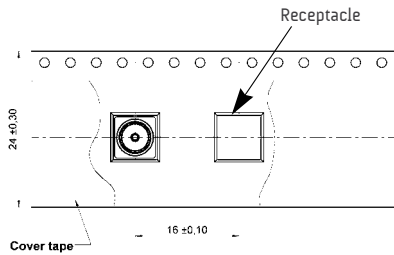

Part number
R123 682 827

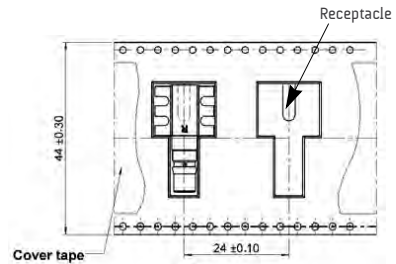

Assembly instructions

M01

Receptacle soldering pattern:

Part number
R123 427 803

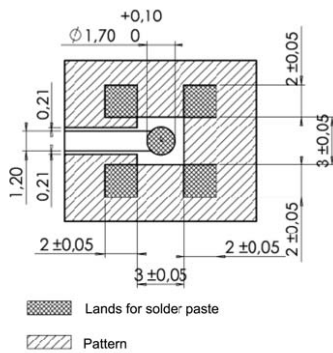

Part number
R123 682 827

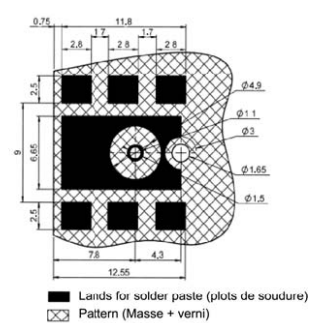

COPLANAR LINE: Pattern and signal are on the same side. Thickness of PCB = 1.6 mm. The material of PCB is the glass epoxy resin (Er = 4.8). The solder paste should be printed except for the land pattern on the PCB.

Video shadow:

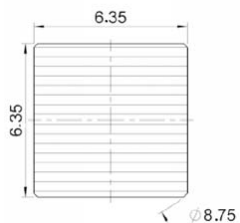

Vaccum nozzle dimensions:

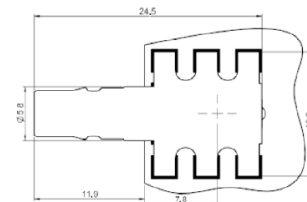
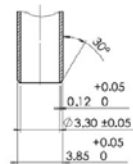

Plugs, jacks and receptacles

STRAIGHT PLUGS

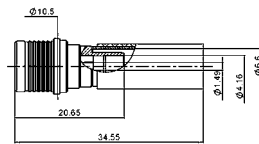

Fig. 1

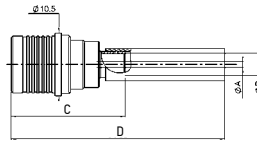

Fig. 2

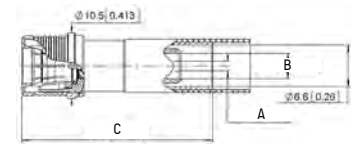

Fig. 3

Cable group	Cable group dia.	Part number	Fig.	Dimensions				Finish	Ingress protection	Note	Packaging
				A	B	C	D				
ECO 230	6/50/D	R123W 096 100	1	-	-			BBR	IP68	Crimp type	100 pieces
Hand formable / RG405	.085"	R123W 054 000	2	0.6	2.275					Solder type	
Hand formable / RG402	.141"	R123W 055 000		1.0	3.70					Crimp type	
AEP-240FR	LMR® 240	R123W 076 310	3	1.5	4.05	30.5	-				

RIGHT ANGLE PLUGS

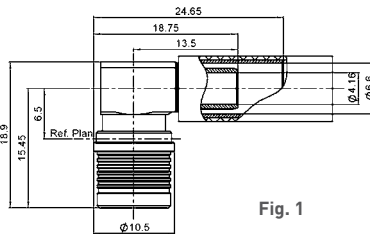

Fig. 1

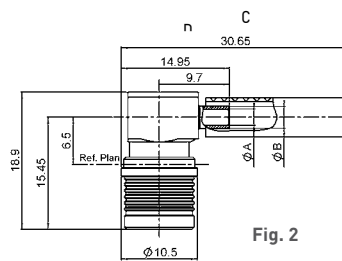
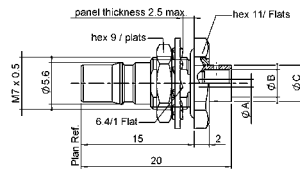

Fig. 2

For assembling, tool **R282 761 000** is recommended

Cable group	Cable group dia.	Part number	Fig.	Dimensions				Finish	Ingress protection	Note	Packaging
				A	B	C	D				
ECO 230	6/50/D	R123W 176 000	1	26.3	3.11			BBR	IP68	Crimp type	100 pieces
Hand formable / RG405	.085"	R123W 153 000	2	2.275	3.05					Solder type	
Hand formable / RG402	.141"	R123W 154 000		3.70	4.40					Crimp type	
AEP-240FR	LMR® 240	R123W 177 110		4.05	6.6	24.65	18.75				

STRAIGHT BULKHEAD JACKS SOLDER TYPE (panel seal)



Cable group	Cable group dia.	Part number	Dimensions			Finish	Ingress protection	Packaging
			A	B	C			
Hand formable / RG405	.085"	R123 326 003	0.60	2.275	3.05	Gold	IP67	100 pieces
Hand formable / RG402	.141"	R123 305 023	1.00	3.70	4.80			

RECEPTACLES (panel seal)

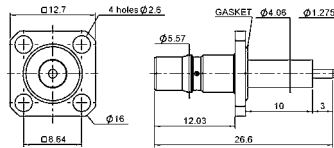

Part number	Finish	Ingress protection	Note	Packaging
R123 425 100	BBR	IP67	Square flange	100 pieces

MALE WATERPROOF PROTECTIVE CAP

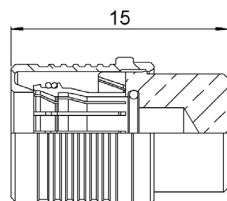
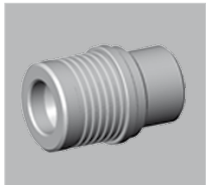

Fig. 1

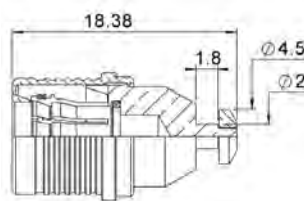

Fig. 2

Part number	Fig.	Finish	Sealing	Packaging
R123W 805 700	1	BBR	IP68	100
R123W 805 710	2			

Characteristics

Test / Characteristics	Values / Remarks
------------------------	------------------

ELECTRICAL CHARACTERISTICS

Impedance	50Ω	
Frequency range	DC - 6 GHz (optimized) DC - 11 GHz (working range)	
Return loss typical <ul style="list-style-type: none"> • DC - 3 GHz • 3 GHz - 6 GHz 	≥ 32 dB / 1.05 ≥ 25 dB / 1.12	
Intermodulation	Better - 155 dBc (2 x 43 dBm)	
RF Leakage	100 MHz to 3 GHz better than - 90 dB 3 to 6 GHz better than - 80 dB	
Dielectric withstanding voltage in VRMS (interface) <ul style="list-style-type: none"> • At sea level, 50 Hz 	2500	
Working voltage in VRMS (interface) <ul style="list-style-type: none"> • At sea level, 50 Hz 	≤ 1000	
Insulation resistance	≤ 5.10 ³ MΩ	
Contact resistance <ul style="list-style-type: none"> • Initial • After test 	Center contact ≤ 1 mΩ ≤ 1.5 mΩ	Outer contact ≤ 0.25 mΩ ≤ 1 mΩ

MECHANICAL CHARACTERISTICS

Durability matings	≥ 100	
Force to engage and disengage <ul style="list-style-type: none"> • Typical 	40 N	
Retention force for interface	≥ 450 N (101.25 Lbs)	
Bending moment admissible interface	≤ 10 Nm	
Contact captivation <ul style="list-style-type: none"> • Cable connectors • Receptacles 	≥ 28 N ≥ 18 N	

ENVIRONMENTAL CHARACTERISTICS

Temperature range	- 55°C + 125°C	
Climatic category	40 / 125 / 21 (IEC 60169 1 16.2)	
Shock	MIL STD 202F, method 213, condition I	
Rapid change of temperature	IEC 60169-1 16.4 (-40°C + 125°C)	
Corrosion salt spray	Test acc. to MIL STD 202F, method 101D, condition B	
Vibration	IEC 1169-1 paragraph 9.3.3 (10-500 Hz; 5g)	
Moisture resistance	MIL STD 202 F, method 106F	
Water resistance	IP 68	

MATERIALS AND PLATING

	Materials	Platings
Body	Brass	BBR over Silver
Center contact	Brass / Beryllium copper	Silver passivated over copper
Outer contact	Beryllium copper	BBR over Silver
Insulator	PTFE	
Others parts	Brass	BBR

All dimensions are given in mm.

Characteristics

POWER RANGE

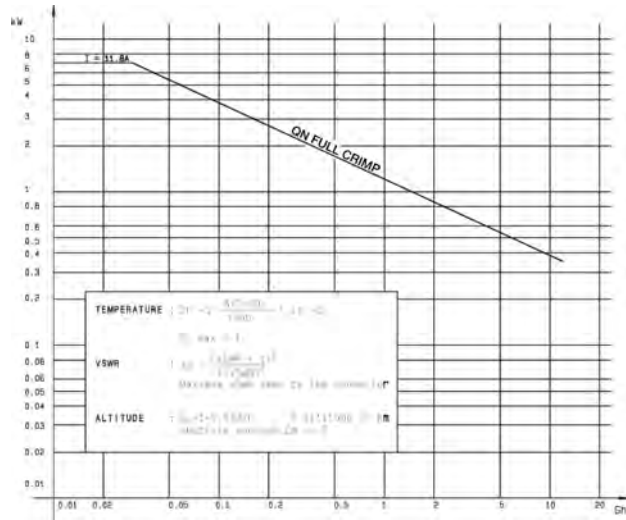

Plugs

STRAIGHT PLUGS, FULL CRIMP TYPE, FOR FLEXIBLE CABLES

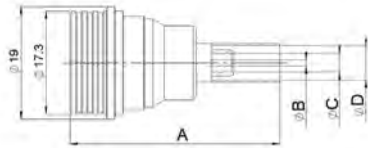

Fig. 1

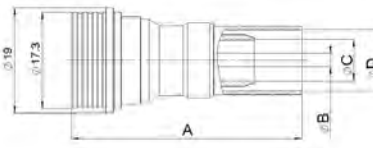
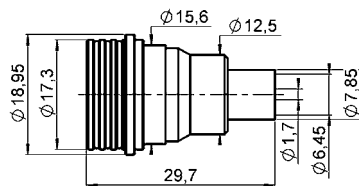

Fig. 2

Cable group	Cable group dia.	Part number	Fig.	Dimensions (mm)				Captive center contact	Packaging
				A	B	C	D		
RG58 / RG141	5/50/S	R164 075 000	1	35.2	1.05	3.1	5.4	no	50 pieces
RG142 / RG223 / RG400	5/50/D	R164 076 000					5.8		
RG213	10/50/S	R164 080 000	2	41.5	2.45	7.5	11.05	yes	Unit
AEP-240FR	LMR® 240	R164 075 010	1	35.2	1.5	4.05	6.6		50
AEP-400FR	LMR® 400	R164 080 020						2	41.5
AEP-600FR	LMR® 600	R164 080 030	2	44.5	4.7	11.96	15.875	no	Unit

STRAIGHT PLUGS, SOLDER TYPE, FOR SEMI-RIGID CABLES



Cable group	Cable group dia.	Part number	Captive center contact	Packaging
RG401	.250"	R164 054 002	no	50 pieces

Plugs and jacks

RIGHT ANGLE PLUGS

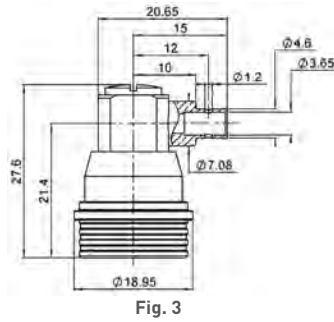
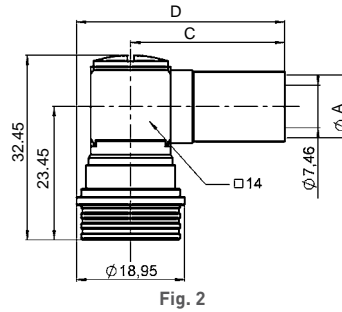
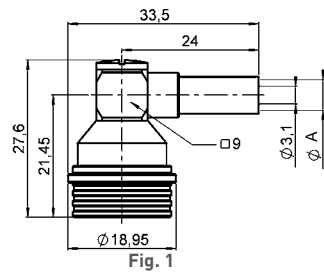

Cable group	Cable group dia.	Part number	Fig.	Dimensions (mm)			Captive center contact	Packaging	Note
				A	C	D			
RG402	.141"	R164 152 100	3						Solder type
RG58 / RG141	5/50/S	R164 175 000	1	5.41	-	-	yes	50 pieces	Crimp type
RG142 / RG223 / RG400	5/50/D	R164 176 000		5.8	-	-			
RG213	10/50/S	R164 184 000	2	11.05	27	36.5			
AEP-240FR	LMR® 240	R164 185 007							

STRAIGHT JACKS

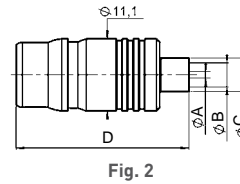
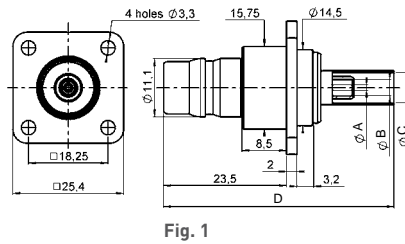

Cable group	Cable group dia.	Part number	Fig.	Dimensions (mm)				Captive center contact	Packaging	Note
				A	B	C	D			
RG213	10/50/S	R164 286 000	1	2.45	7.46	11.05	46.1	no	50 pieces	25.4 mm square flange crimp type
RG402	.141"	R164 336 000	2	0.97	3.68	5.18	26.6	yes		Solder type

Jacks and receptacles

BULKHEAD STRAIGHT JACKS (panel seal)

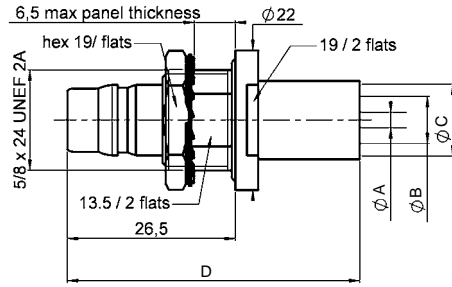

Fig. 1

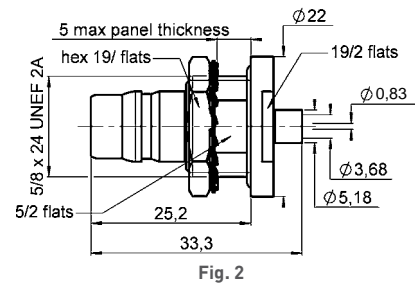
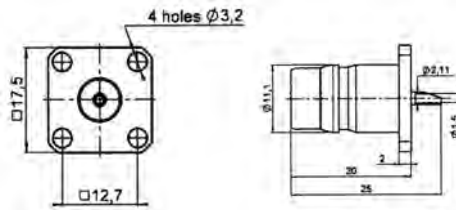

Fig. 2

Cable group	Cable group dia.	Part number	Fig.	Dimensions (mm)				Captive center contact	Panel drilling	Packaging	Note
				A	B	C	D				
RG142 / RG223 / RG400	5/50/D	R164 329 200	1	1.05	3.11	5.8	44.1	no	P03	50 pieces	Rear mount Full crimp type
RG402	.141"	R164 635 002	2					yes			Rear mount Solder type
AEP-400FR	LMR® 400	R164 241 020	3	46.1	2.82	7.46	11.05				Crimp type

SQUARE FLANGE, STRAIGHT FEMALE RECEPTACLE



Part number	Captive center contact	Panel drilling	Packaging	Note
R164 418 000	yes	P01	50 pieces	Solder pot 17.5 square flange

RECEPTACLES

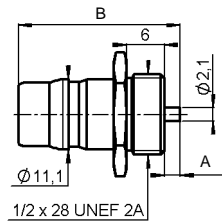

Fig. 1

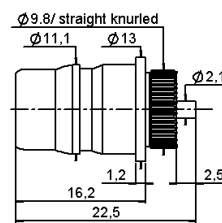
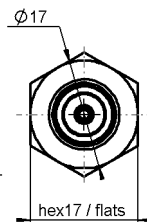

Fig. 2

Part number	Fig.	Dimensions (mm)		Captive center contact	Panel drilling	Packaging	Note
		A	B				
R164 571 027	1	2.5	25.5	yes	P02	50 pieces	Screw-on front mounting
R164 540 027	2						Press-in

Receptacles and adapters

WATERPROOF RECEPTACLES

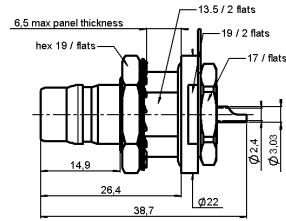

Fig. 1

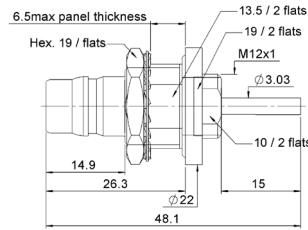

Fig. 2

Part number	Fig.	Captive center contact	Panel drilling	Packaging	Note
R164 606 000	1	yes	P03	50 pieces	IP68
R164 606 020	2				

IN SERIES ADAPTERS

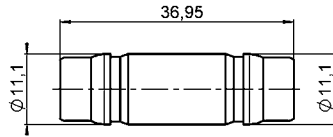

Fig. 1

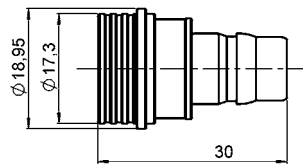

Fig. 2

Part number	Fig.	Captive center contact	Packaging	Note
R164 705 000	1	yes	50 pieces	QN female - QN female
R164 708 000	2			QN male - QN female

BETWEEN SERIES ADAPTERS QN/N

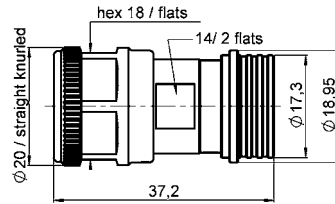

Fig. 1

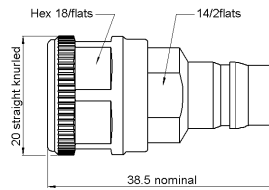

Fig. 2

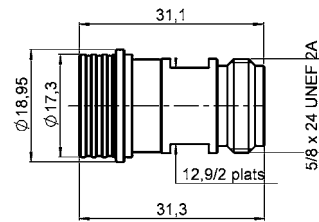

Fig. 3

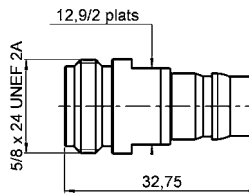
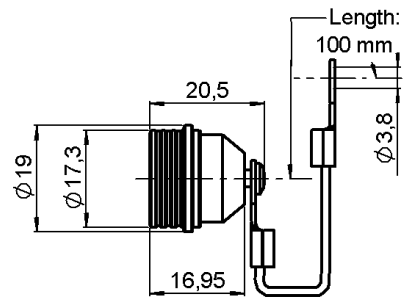

Fig. 4

Part number	Fig.	Captive center contact	Packaging	Note
R191 757 000	1	yes	Unit	QN male - N male
R191 758 000	2			QN female - N male
R191 759 000	3			QN male - N female
R191 760 000	4			QN female - N female

Protective CAP

PROTECTIVE CAP



Part number	Designation
R164 804 000	male

Panel drilling

P01

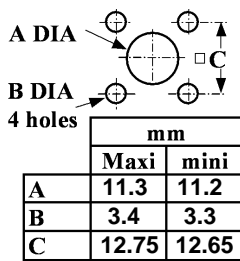

P02

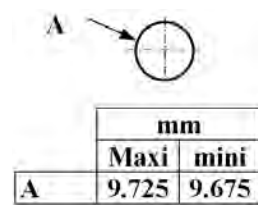

P03

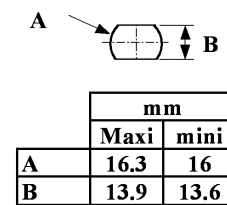

Introduction

QRE™ is a Quick Lock Ruggedized connector. QRE™ was developed to provide the same advantages as QMA over SMA and designed more for aerospace and defense applications.

QRE™ is made of high grade stainless steel 316L, with Teflon coated fluorosilicone sealing o-rings which make the QRE™ interface waterproof and ultra resistant to chemical aggression and corrosion. The outer slotted spring contact inspired from the QMA design was reinforced to provide reliable electrical contact during vibration and shock conditions. All QRE™ material were chosen and optimized to operate within the extended temperature range typical in Mil-Aerospace applications. Its superior latching mechanism provides the advantage of a snap-on connector while ensuring a very robust and secure connection. The retention force of the interface is 3 times higher than the QMA. With similar dimensions, QRE™ offers high density integration capabilities like QMA. In addition, a specific tool has been designed to easily disconnect QRE™ plugs on high density applications such as active array radar modules or panels.

A limited range of straight and right angle connectors and receptacles is available for semi-rigid and SHF high frequency flexible cable. New connectors can be quickly developed to fit your own ruggedized coaxial cable. QRE™ cable assemblies can be delivered using our SHF airframe, lightweight or outdoor cables, with or without antiabrasion jacket. Adapters are available for test and measurement in QRE™ to SMA and QRE™ to SMA 3.5 configurations.

Characteristics

Test / Characteristics	Values / Remarks
ELECTRICAL CHARACTERISTICS	
Impedance	50Ω
Frequency range	DC - 12.4 GHz
V.S.W.R. typical	
• DC - 3 GHz	1.06
• 3 GHz - 6 GHz	1.11
• 6 GHz - 12.4 GHz	1.17
Max insertion loss	0.25
Insulation resistance	5000 MΩ min
Voltage rating	335 Veff max
Dielectric withstanding voltage	1000 Veff min
Admissible power (CW)	450 W @ 1 GHz - 100 W @ 18 GHz
RF leakage	-95 dB min @ 3 GHz -80 dB min @ 12.4 GHz

MECHANICAL CHARACTERISTICS

Durability	100 matings (500 matings option is available)
Engagement and disengagement forces	65 N typ
Retention force for interface	150 N min
Minimum connector pitch	12.4 mm (distance between center conductors)
Vibration	MIL STD 202 method 204 condition D
Shock	MIL STD 202 method 213 condition I

ENVIRONMENTAL CHARACTERISTICS

Temperature range	-55/+165°C
IP rating (when mated)	IP 68
Hermeticity (when mated)	10 ⁻⁶ atm.cm ³ /s (CEI 68-2-17 Method Qk)

MATERIALS AND PLATING

	Materials	Platings
Connector bodies	Stainless steel 316L	Passivated
Center contacts	Beryllium copper	Gold over Nickel
Outer contact	Beryllium copper	NPGR
Insulators	PTFE	
O-rings	Fluorosilicone	

All dimensions are given in mm.

Plugs, jacks and receptacle

STRAIGHT AND RIGHT ANGLE PLUGS, SOLDER TYPE

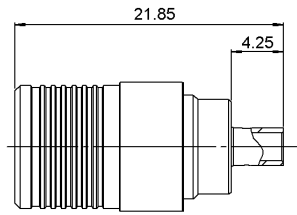

Fig. 1

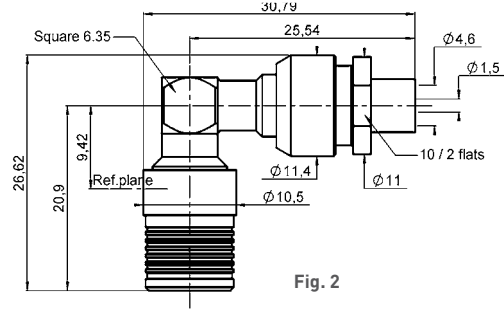

Fig. 2

Cable group	Cable group dia.	Part number	Fig.	Captive center contact	Finish
RG 405	.085"	R324 054 L01	1	no	Passivated
RG 402	.141"	R324 055 L00			
SHF5MAF	Special	R324 195 L02	2		

Note:

For other semi-rigid or flexible cables, please contact us.

STRAIGHT FLANGE JACK SOLDER TYPE FOR SEMI-RIGID CABLE

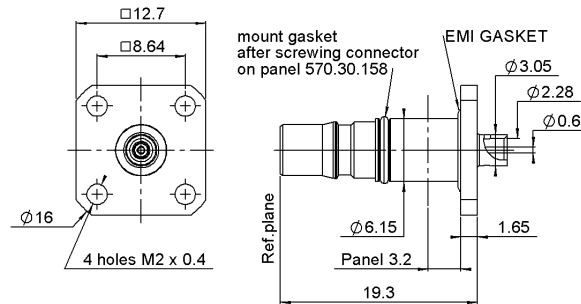

Cable group	Cable group dia.	Part number	Captive center contact	Panel drilling	Finish
RG 405	.085"	R324 256 L01	yes	P01	Passivated

STRAIGHT FLANGE FEMALE RECEPTACLE

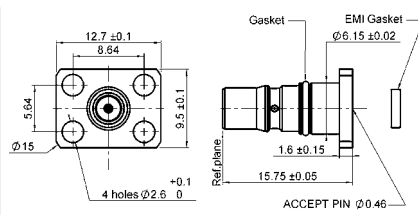

Fig. 1

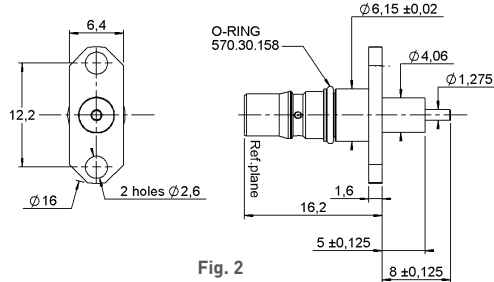

Fig. 2

Part number	Fig.	Captive center contact	Panel drilling	Finish	Note
R324 434 L01	1	yes	P02	Passivated	EMI Gasket
R324 474 L00	2		P03		

Note:

Replacement O-rings and EMI gaskets available to order, please contact us.

Adapters and extraction tool

HERMETIC SCREW-IN FEMALE RECEPTACLE

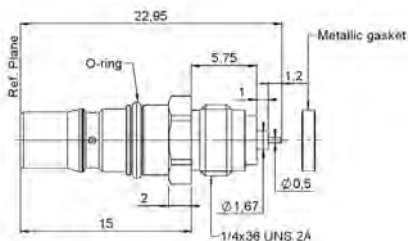

Part number	Captive center contact	Panel drilling	Finish	Note
R324 555 L01	yes	P04	Passivated	Metallic gasket

BETWEEN SERIES ADAPTERS QRE/SMA

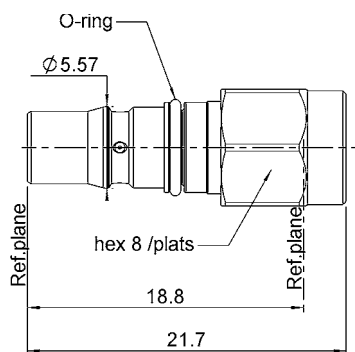
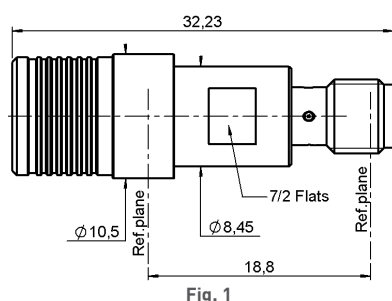

Part number	Fig.	Captive center contact	Finish	Note
R191 926 L01	1	yes	Passivated	QRE™ male – SMA female
R191 927 L01	2			QRE™ female – SMA male

Note:
For QRE™ to SMA 3.5 adapters, please contact us.

QRE™ EXTRACTION TOOL

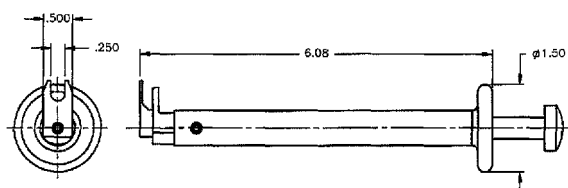

Part number
TA-0457

This tool can be used with either straight or right angle connectors.

Panel drilling

P01

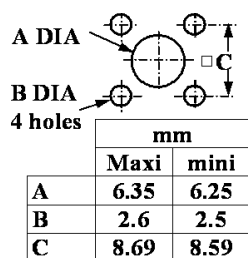

P02

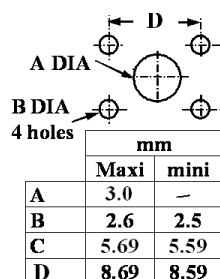

P03

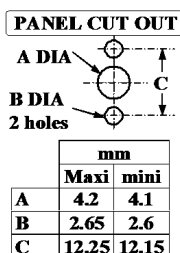

P04



SECTION 9



BNC / BNC 75 HDTV / BNC-TRX

R141 / R142 / R266



Contents

BNC

Introduction 9-4 to 9-5
Interfaces 9-6 to 9-7
Characteristics 9-8 to 9-11
Panel drilling 9-31 to 9-32

COMPOSITE BNC 75 HDTV

Plugs 9-12

BNC 75 HDTV

Plugs 9-13
Jacks 9-14
Receptacles 9-14
Adapters 9-15

BNC 50Ω

Plugs 9-16 to 9-17
Jacks 9-18 to 9-19
Receptacles 9-20 to 9-22
Adapters 9-23 to 9-24
Caps 9-24

BNC 75Ω

Plugs 9-25 to 9-26
Jacks 9-26 to 9-27
Receptacles 9-28
Adapters 9-29

BNC-TRX

Characteristics 9-30
Plugs 9-30
Jacks 9-30
Receptacles 9-30

Introduction



50Ω	DC - 4 GHz
	DC - 1.5 GHz (commercial)
	DC - 1.0 GHz (Eco)
	DC - 10 GHz (TRIAxIAL)
75Ω	DC - 1.5 GHz
	DC - 6 GHz (HDTV)
	DC - 1.0 GHz (Eco)

GENERAL

- Worldwide standardized coaxial connectors
- Bayonet coupling
- Proven strength and reliability
- Good RF performance

APPLICABLE STANDARDS

- MIL-C-39012 / MIL STD 348-A/301
- IEC 169-8
- CECC 22120
- NF-C-93564 KBN series
- UTE-C-93564

APPLICATIONS

- Civil and military radio-telecommunication equipment
- Test and measurement
- Video communication
- Broadcast
- Industrial network
- General electronics

The BNC connector is the most popular coaxial connector series in the world, featuring a two-pin bayonet coupling system for quick and reliable engagement and disengagement.

• Wide range:

Radiall's BNC connectors are available with two characteristic impedances: 50Ω and 75Ω. They are completely intermateable. RADIALL also offers low-cost BNC range, and a triaxial BNC TRX series.

• Convenient three piece design:

Straight and right angle crimp type cable connectors feature a three piece design: single piece body + center contact + outer ferrule.



Introduction

• Fast and reliable cable attachment

- Cable connectors can be either fully crimped or soldered/crimped, offering full flexibility for fast, reliable, high-volume production with standard manual or pneumatic tooling.
- The center contact can be either crimped or soldered,
- The outer contact is attached to the cable by crimping a ferrule.

COMPOSITE BNC 75Ω HDTV CONNECTOR

GENERAL

- The first lightweight composite HDTV BNC available on the market
- Easy to connect and disconnect from the rear—ideal for high-density and recessed bulkhead applications
- Color-coded boots directly on the connector for easy video signal identification
- Guaranteed frequency up to 6 GHz for studio-quality performance
- 1000 mating cycles minimum for guaranteed durability in the field
- True 75Ω design

HDTV places new demands on maintaining high signal integrity at high data rates, from studio-quality broadcast production to video conferencing equipment, our selection of affordable HDTV BNC connectors offer more bandwidth, more performance, and are easier to use.

Our new technologically advanced high-speed composite BNC 75Ω HDTV connector features an incredible easy-to-use two-piece design that makes it easy to crimp on the cable. This new connector can handle data rates up to 3 Gbps or higher while meeting or exceeding SMPTE 292M and 424M standards. The gold plated center and outer contacts provide outstanding electrical performance with a frequency range of up to 6 GHz, and a low return loss of -32 dB at 3 GHz.

The connector comes in a wide variety of colors for signal cable identification and its special curved interface composite material design with positioning marks makes it easy and fast to connect in high-density and recessed bulkhead applications.

APPLICATIONS

- Broadcast TV stations and studios
- Video routing and production
- Video surveillance equipment
- Video conference equipment



BNC 75 HDTV/BNC 50Ω

Interface BNC 75 HDTV

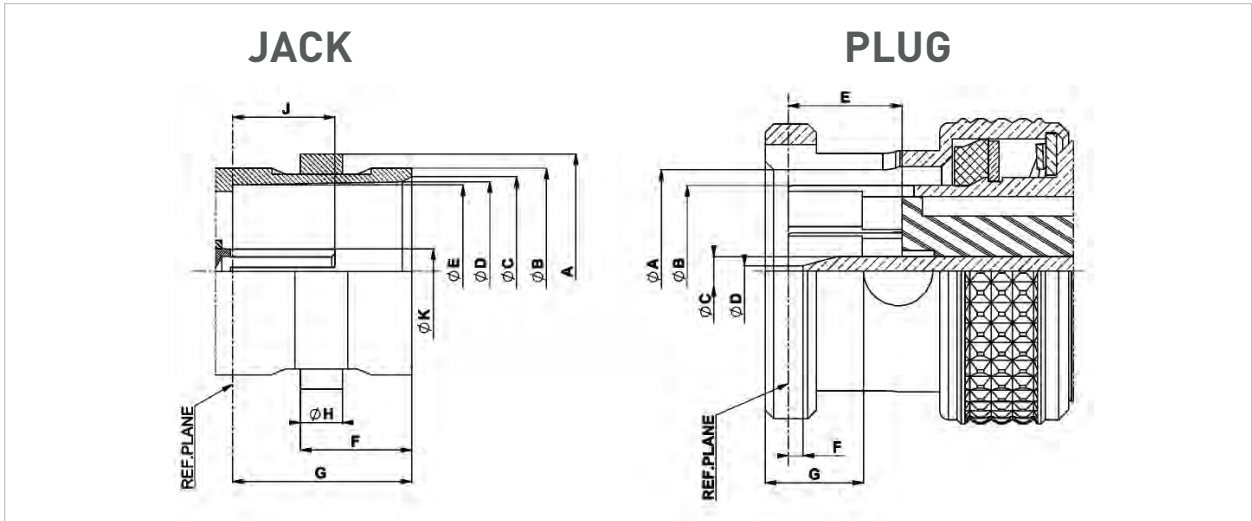

Letter	mm		inch	
	min.	max.	min.	max.
A	10.97	11.07	.432	.436
B	9.60	9.67	.378	.381
C	8.80	9.00	.346	.354
D	8.32	8.46	.328	.333
E	8.10	8.15	.319	.321
F	5.18	5.28	.204	.208
G	8.30	8.50	.327	.335
H	1.90	2.06	.075	.081
J	4.72	5.22	.186	.206
K	2.10	2.14	.083	.084

Letter	mm		inch	
	min.	max.	min.	max.
A	9.80	9.90	.386	.390
B	8.30	8.40	.327	.331
C	1.32	1.37	.052	.054
D	0.35	0.65	.014	.026
E	5.30	5.50	.209	.217
F	0.10	0.90	.004	.035
G	4.57	4.67	.180	.184

Interface BNC 50Ω

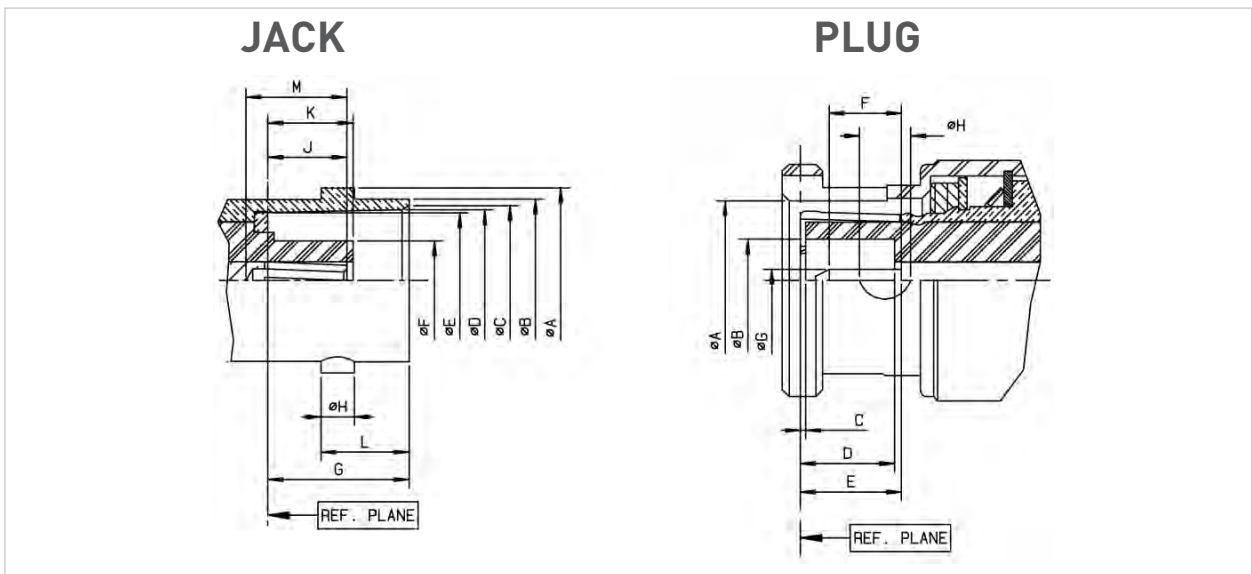

Interface BNC 50Ω

Letter	mm		inch	
	min.	max.	min.	max.
A DIA	10.97	11.07	.432	.436
B DIA	9.60	9.70	.378	.382
C DIA	8.79	9.04	.346	.356
D DIA	8.31	8.46	.327	.333
E DIA	8.10	8.15	.319	.321
F DIA	-	4.72	-	.186
G	8.31	8.51	.327	.335
H	1.91	2.06	.075	.081
J	4.72	5.23	.186	.206
K	4.78	5.28	.188	.208
L	5.18	5.28	.204	.208
M	4.95	-	.195	-

Letter	mm		inch	
	min.	max.	min.	max.
A DIA	9.78	9.91	.385	.390
B DIA	4.83	-	.190	-
C	0.15	-	.006	-
D	5.28	5.79	.208	.228
E	5.33	5.84	.210	.230
F	1.98	-	.078	-
G DIA	1.32	1.37	.052	.054
H DIA	2.31	2.46	.091	.097

Interface BNC 75Ω

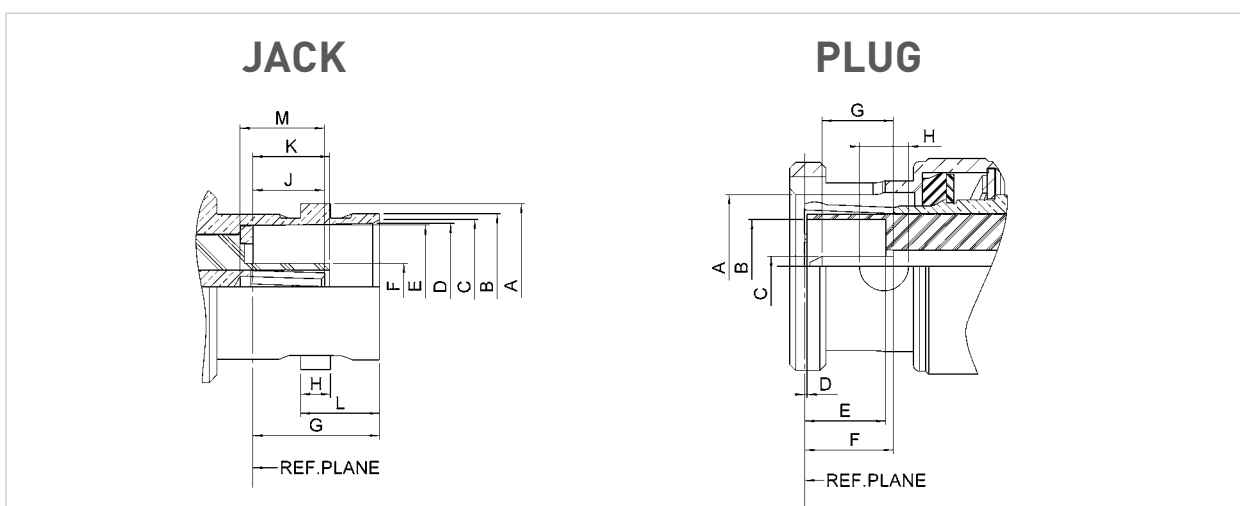

Letter	mm		inch	
	min.	max.	min.	max.
A DIA	10.97	11.07	.432	.436
B DIA	9.60	9.67	.378	.381
C DIA	8.80	9.00	.347	.354
D DIA	8.32	8.46	.328	.333
E DIA	8.10	8.15	.319	.321
F DIA	4.62	4.72	.182	.186
G	8.30	8.50	.326	.334
H	1.90	2.06	.074	.081
J	4.72	5.22	.186	.205
K	4.98	5.23	.196	.206
L	5.18	5.28	.204	.208
M	5.30	5.90	.209	.232

Letter	mm		inch	
	min.	max.	min.	max.
A DIA	9.80	9.90	.386	.389
B DIA	6.10	6.30	.240	.248
C DIA	1.32	1.37	.052	.054
D	0.05	-	.002	-
E	5.42	5.78	.213	.227
F	5.35	5.87	.211	.231
G	3.00	3.40	.118	.134
H DIA	3.15	3.35	.124	.132

Characteristics

ELECTRICAL CHARACTERISTICS

Frequency range	DC - 6 GHz (optimized at 3 GHz)		
Impedance	75Ω		
V.S.W.R. (max) • Interface (plug + jack) • Mated pair • In series adapters	DC - 1.5 GHz	1.5 - 3 GHz	3 - 6 GHz
	1.02	1.05	1.08
	1.05	1.12	1.25
	1.04	1.07	1.12
Working voltage	500 Vrms		
Dielectric withstanding voltage	1500 Vrms		
RF Leakage @ 1 GHz	75 dB		
RF Leakage @ 3 GHz	60 dB		
RF Leakage @ 6 GHz	50 dB		

MECHANICAL CHARACTERISTICS

Mating	Intermateable with 50Ω and 75Ω standard BNC connectors
Long life duration (mating endurance)	1000 cycles
Engagement force	13.6 N
Mating torque (bayonet)	28.6 N.cm
Coupling nut retention force	Axial force: 450 N Bending stress: 1000 N.cm
Center contact insertion force	10 N max
Vibration	MIL STD 202 Meth.204 cond B

ENVIRONMENTAL CHARACTERISTICS

Temperature range	-65°C + 165°C
Moisture resistance	MIL STD 202, Meth. 106 CECC 22000 paragraph 4.6.6
Corrosion resistance	MIL STD 202, Meth. 101 cond B (48 hours salt spray)

MATERIALS AND PLATING

Components	Materials	Platings
Body	Brass	NPGR/BBR/Nickel
Center contact	Brass or Beryllium copper	NPGR
Outer contact	Brass	NPGR
Insulator	PTFE	
Gasket	Silicone Rubber	

Composite version

CHARACTERISTICS

Frequency range	DC up to 6GHz
Impedance	75 Ω
VSWR	1.05 @ 3GHz (Return loss -32dB)
Mating Cycles	1000
Temperature Range	-40 °C ~ + 85 °C

MATERIAL AND PLATING

Parts	Materials	Plating
Coupling Nut	Composite	
Body	Brass	Gold
Outer contact	Brass	Gold
Center Contact	Brass	Gold
Insulator	PTFE	

Characteristics

Test / Characteristics	Standard reference	Values / Remarks
------------------------	--------------------	------------------

ELECTRICAL CHARACTERISTICS

Test / Characteristics	Standard reference	Values / Remarks												
Impedance		50Ω												
Frequency range		DC - 4 GHz												
Typical V.S.W.R. • Straight models cable groupe: 2/50, 2.6/50, 5/50, 10 + 11/50, .141" • Right angle models: 2/50, 2.6/50, 5/50		<table border="1"> <tr> <td>1 GHz</td> <td>2.5 GHz</td> <td>4 GHz</td> </tr> <tr> <td>1.12</td> <td>1.18</td> <td>1.22</td> </tr> <tr> <td></td> <td>1.30 max</td> <td></td> </tr> <tr> <td>1.13</td> <td>1.20</td> <td>1.22</td> </tr> </table>	1 GHz	2.5 GHz	4 GHz	1.12	1.18	1.22		1.30 max		1.13	1.20	1.22
1 GHz	2.5 GHz	4 GHz												
1.12	1.18	1.22												
	1.30 max													
1.13	1.20	1.22												
Insertion loss • Straight connector • Right-angle connector		<table border="1"> <tr> <td>0.05</td> <td>0.07</td> <td>0.13</td> </tr> <tr> <td>0.08</td> <td>0.16</td> <td>0.20</td> </tr> </table>	0.05	0.07	0.13	0.08	0.16	0.20						
0.05	0.07	0.13												
0.08	0.16	0.20												
RF leakage		-55 dB min from 2 to 3 GHz												
Insulation resistance		5000 MΩ min												
Contact resistance • Center contact • Outer contact	MIL	1.5 mΩ 0.2 mΩ												
Working voltage in VRMS • At sea level (at 21 000m)		500 125												
Dielectric withstanding voltage in VRMS • At sea level (at 21 000m)		1500 375												
RF testing voltage in VRMS Sea level (5 MHz)		1000												

MECHANICAL CHARACTERISTICS

Test / Characteristics	Standard reference	Values / Remarks
Durability		500 matings
Force to engage and disengage • Axial • Torque		13.6 N max 28.6 Ncm
Coupling nut retention force		445 N
Cable retention force • Cable 2/50, 2.6/50 • Cable 5/50, 10 + 11/50 • Cable .141"	MIL	227 N
Center contact retention force		27.2 N

ENVIRONMENTAL CHARACTERISTICS

Test / Characteristics	Standard reference	Values / Remarks
Temperature range • Flexible cables • Semi-rigid cables		-65°C + 165°C -65°C + 105°C
Thermo cycling test		MIL STD 202, method 107, condition B
Thermal shock		MIL STD 202, method 107, condition B
High temperature endurance		MIL STD 202, method 108
Corrosion salt spray		MIL STD 202, method 101, condition B
Vibration		MIL STD 202, method 204, condition B
Shock		MIL STD 202, method 213, condition G
Moisture resistance		MIL STD 202, method 106
Hermetic test		MIL STD 202, method 112, condition C vacuum 10 ⁻⁶ Hgmm (Torr) leakage rate < 10 ⁻⁶ atm/cm ³ /s
Barometric pressure		Pressure test: 3.5 bars; duration: 2 mn; temperature: 15°C to 25°C

MATERIALS AND PLATING

	Materials	Platings
Bodies	Brass	Nickel / BBR
Center contact • Male • Female	Brass Bronze or heat treated beryllium following QQ-C-530	Gold
Nut	Brass	
Insulator	PTFE	
Gasket	Silicon Rubber	

All dimensions are given in mm.

Go online for data sheets & assembly instructions.



Visit www.radiall.com and enter the part number.

Characteristics

Test / Characteristics	Standard reference	Values / Remarks
------------------------	--------------------	------------------

ELECTRICAL CHARACTERISTICS

Impedance		75Ω
Frequency range		DC - 1.5 GHz
V.S.W.R. max		1.30
<ul style="list-style-type: none"> • Straight models cable group: 2.6/75, 5/75, 6/75, 8/75, 10 + 11/75 • Right angle models: 2.6/75, 6/75 		1.35
Insertion loss		0.2 dB max at 1 GHz 0.3 dB max at 1 GHz
<ul style="list-style-type: none"> • Straight connector • Right-angle connector 		
RF leakage		-55 dB min from 2 to 3 GHz
Insulation resistance		5000 MΩ min
Contact resistance	MIL	1.5 mΩ 0.2 mΩ
<ul style="list-style-type: none"> • Center contact • Outer contact 		
Working voltage in VRMS		500 125
<ul style="list-style-type: none"> • At sea level (at 21 000m) 		
Dielectric withstanding voltage in VRMS		1500 375
<ul style="list-style-type: none"> • At sea level (at 21 000m) 		
RF testing voltage in VRMS	Sea level (5 MHz)	1000

MECHANICAL CHARACTERISTICS

Durability		500 matings	
Force to engage and disengage	MIL	13.6 N max 28.6 Ncm	
<ul style="list-style-type: none"> • Axial • Torque 			
Coupling nut retention force		445 N	
Cable retention force		Cable 2.6/75, 5/75 6/75, 8/75, 10 + 11/75	340 N
Center contact retention force		27 N	

ENVIRONMENTAL CHARACTERISTICS

Temperature range	flexible cables	MIL	-65°C + 165°C
Thermo cycling test			MIL STD 202, method 107, condition B
High temperature endurance			MIL STD 202, method 108
Corrosion salt spray			MIL STD 202, method 101, condition B
Vibration			MIL STD 202, method 204, condition B
Shock			MIL STD 202, method 213, condition G
Moisture resistance			MIL STD 202, method 106
Barometric pressure			Pressure test: 3.5 bars; duration: 2 mn; temperature: 15°C to 25°C

MATERIALS AND PLATING

	Materials	Platings
Bodies	Brass	Nickel
Center contact	Brass Bronze or heat treated beryllium following QQ-C-530	Gold
<ul style="list-style-type: none"> • Male • Female 		
Nut	Brass	
Insulator	PTFE	
Gasket	Silicone Rubber	

Standard packaging = 100 pieces

Go online for data sheets & assembly instructions.



Visit www.radiall.com and enter the part number.

Characteristics

Commercial version R141 XXX 161 and R142 XXX161

ELECTRICAL CHARACTERISTICS

	R141 XXX 161	R142 XXX 161
Impedance	50Ω	75Ω
Operating frequency	DC to 1.5 GHz	
Typical V.S.W.R. (1.5 GHz)		
• Straight models	∅ 2.6	1.21
	∅ 5	1.14
	∅ 6	1.05
• Right angle models	∅ 5 & ∅ 6	1.17
Testing voltage (VRMS)	1500	
Operating voltage (VRMS)	500	
Insulation resistance (MΩ)	5000	
Contact resistance (mΩ)	10	

MECHANICAL CHARACTERISTICS

Durability	100 matings
------------	-------------

ENVIRONMENTAL CHARACTERISTICS

Temperature range	-40°C + 85°C
-------------------	--------------

MATERIALS AND PLATING

	Materials	Platings
Male and female bodies	Brass	Nickel
Coupling nut	Die cast zinc	
Outer contact	Brass	
Insulators	Polypropylene	
Male and female center contacts	Brass	Gold

ECO version R141A XXX XXX and R142A XXX XXX

ELECTRICAL CHARACTERISTICS

	R141A XXX XXX	R142A XXX XXX
Impedance	50Ω	75Ω
Frequency range	DC - 1 GHz	
Typical V.S.W.R. (straight models)	1.3 at 1 GHz	
Temperature range	-40°C / +85°C	
Durability	100 mating cycles	

MATERIALS AND PLATING

	Materials	Platings
Connector body	Brass/Die cast zinc	Nickel
Insulators	PTFE/Polypropylene	
Female center contacts	Phosphor bronze	Gold 0.1µm typical (Center contact)

PACKAGING

Packaging	100 pieces bulk Unit packaging
-----------	-----------------------------------

Standard packaging = 100 pieces

All dimensions are given in mm.

Plugs

STRAIGHT PLUGS CRIMP TYPE FOR FLEXIBLE CABLES

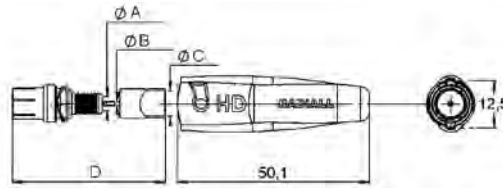

Cable group	Cable group dia.	Part number	Color	Dimensions			
				A	B	C	D
Mini RG59 Belden 1855A, DRAKA 0.6/2.8 CAE HD 0628	0.6/2.8	R142 079 750	Black	2.85	0.65	5.42	26.7
		R142 079 751	Red				
		R142 079 752	Green				
		R142 079 753	Blue				
		R142 079 754	Yellow				
		R142 079 755	Grey				
		R142 079 756	White				
		R142 079 757	Brown				
		R142 079 758	Orange				
		R142 079 759	Violet				
RG59 BELDEN 1505A DRAKA 0.8/3.7 ARGOSY Image 720 CAE HD 08370	0.8/3.7	R142 079 760	Black	3.75	0.85	6.6	25.7
		R142 079 761	Red				
		R142 079 762	Green				
		R142 079 763	Blue				
		R142 079 764	Yellow				
		R142 079 765	Grey				
		R142 079 766	White				
		R142 079 767	Brown				
		R142 079 768	Orange				
		R142 079 769	Violet				
RG6 BELDEN 1694A DRAKA 1.0/4.8 ARGOSY Image 1000 CAE 10460	1.0/4.8	R142 079 770	Black	4.85	1.05	7.1	23.7
		R142 079 771	Red				
		R142 079 772	Green				
		R142 079 773	Blue				
		R142 079 774	Yellow				
		R142 079 775	Grey				
		R142 079 776	White				
		R142 079 777	Brown				
		R142 079 778	Orange				
		R142 079 779	Violet				

Plugs

STRAIGHT PLUGS CRIMP TYPE FOR FLEXIBLE CABLES

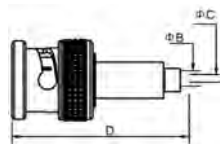

Fig. 1

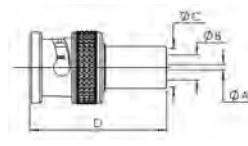
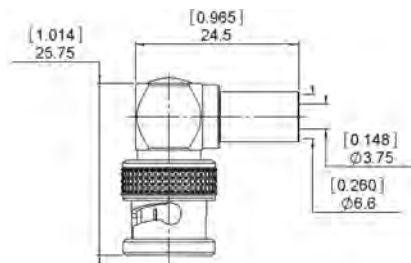

Fig. 2

Cable group	Cable group dia.	Part number	Fig.	Dimensions mm (inch)				Packaging	Note	
				A	B	C	D			
RD179 BELDEN179DT, DRAKA0.31/1.45 AF, CAE HD 03140	0.3/1.4	R142 077 742	1		1.55	0.4	29.7	100		
Mini RG59 Belden 1855A, Draka 0.6/2.8 AF, CAE HD 0628	0.6/2.8	R142 077 702	2	0.85 (.03)	2.85 (.11)	5.42 (.21)	27.68 (1.09)	100	Hexagonal crimp tool 1.73/6.48	
Mini RG59 Argosy Image 360	0.6/2.95	R142 077 712			3.00 (.12)					
RG59 Belden 1505A, Draka 0.8/3.7 AF, CAE HD 08370, Argosy Image 720	0.8/3.7	R142 077 722			3.75 (.15)	6.60 (.26)	26.68 (1.05)			
		R142 085 702			0.90	3.95	6.60			28.68
RG6 Belden 1694A, Draka 1.0/4.8 AF, CAE HD 10460, Argosy Image 1000	1.0/4.8	R142 077 732			1.05 (.04)	4.85 (.19)	7.50 (.30)			26.68 (1.05)
RG11 Belden 7731, Draka 1.6/7.3 AF, CAE HD16720, Argosy Image 2000	1.6/7.3	R142 077 747			1.70	7.45	11.05			32

RIGHT ANGLE PLUG CRIMP TYPE FOR FLEXIBLE CABLE



Cable group	Cable group dia.	Part number	Packaging
RG59 Belden 1505A, Draka 0.8/3.7 AF, CAE HD 08370, Argosy Image 720	0.8/3.7	R142 187 720	100

Jacks and receptacles

STRAIGHT BULKHEAD JACK CRIMP TYPE FOR FLEXIBLE CABLE

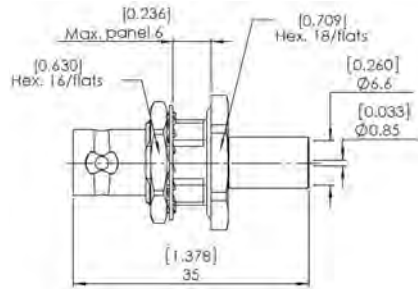

Cable group	Cable group dia.	Part number	Panel drilling	Packaging
RG59 Belden 1505A, Draka 0.8/3.7 AF, CAE HD 08370, Argosy Image 720	0.8/3.7	R142 334 700	P16	100

PCB FEMALE RECEPTACLES

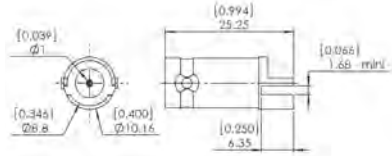

Fig. 1

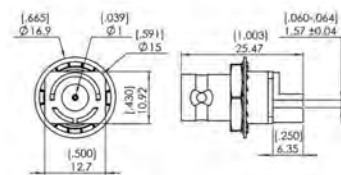

Fig. 2

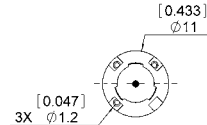
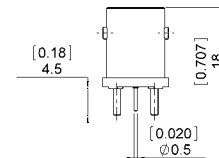
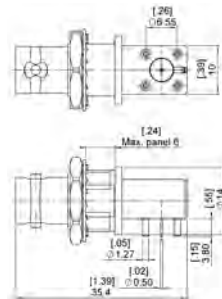

Fig. 3



Part number	Fig.	Captive center contact	Panel drilling	Packaging	Note
R142 568 703	1	yes	P20	100	Edge mount PCB
R142 567 703	2				Bulkhead Edge mount PCB
R142 500 740	3				Straight PCB, Zamak

RIGHT ANGLE PCB FEMALE RECEPTACLES



Part number	Captive center contact	Note
R142 676 700	yes	Bulkhead

Adapters

IN SERIES ADAPTERS

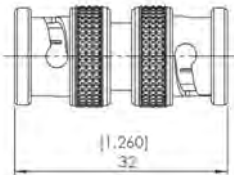

Fig. 1

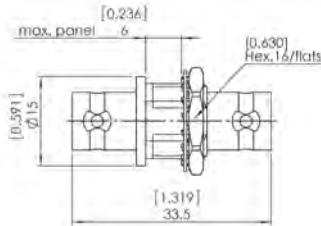

Fig. 2

Part number	Fig.	Captive center contact	Panel drilling	Note	Packaging
R142 703 703	1	yes		male-male	100
R142 720 700	2		P16	female-female	

BETWEEN SERIES ADAPTERS

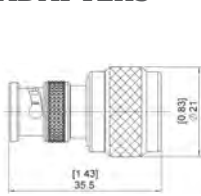

Fig. 1

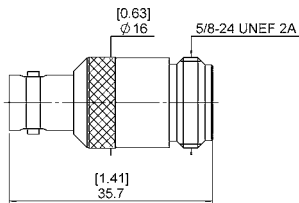
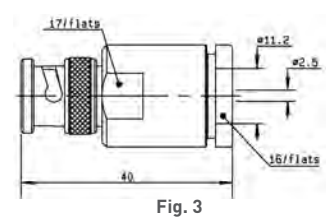
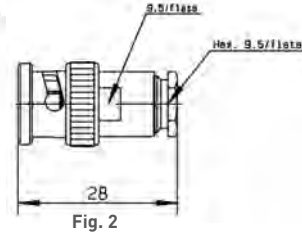
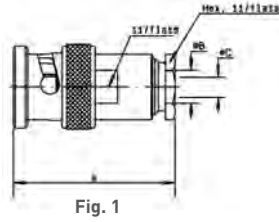

Fig. 2

Part number	Fig.	Captive center contact	Note
R192 417 010	1	yes	BNC HD male - N male
R192 418 010	2		BNC HD female - N female

Straight plugs

STRAIGHT PLUGS CLAMP TYPE



Cable group	Cable group dia.	Part number	Fig.	Dimensions (mm)			Captive center contact	Note			
				A	B	C					
RG178 / RG196	2/50/S + D	R141 003 000	1	27	2.2	0.6	yes				
RG174 / RG316 / RD316 / RG179	2.6/50+75/S+D	R141 004 000			3.1						
PPD Cable	3.5/50	R141 005 000	2	28	3.7	1.2	no				
RG58 / RG141	5/50/S	R141 007 000 R141 007 161									
RG58 / RG141 / RG142 / RG223 / RG400	5/50/S + D	R141 008 000	1	28	5.6	1.2	no				
		R141 009 000						28	5.6	1.2	yes
		R141 010 000									
RG59 / RG62	6/75+93	R141 012 000		27.5	6.6	1.05	no				
RG213 / RG393 / RG214 / RG216	10 + 11/50/S + D	R141 018 000	3				yes				
RG402	.141"	R141 052 000	1	29	3.65	1.2	no	Semi-rigid cable			

STRAIGHT PLUGS FULL CRIMP TYPE FOR FLEXIBLE CABLES

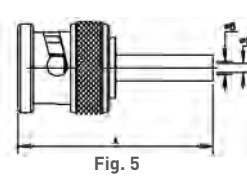
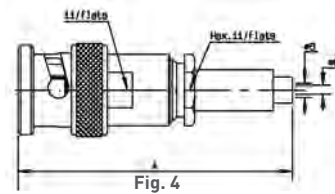
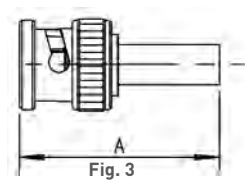
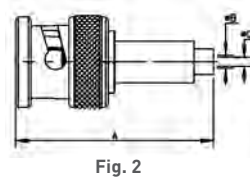
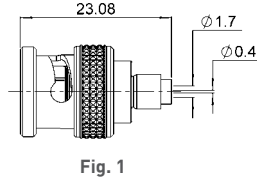

Cable group	Cable group dia.	Part number	Fig.	Dimensions (mm)			Captive center contact	Note
				A	B	C		
RG178 / RG196	2/50/S	R141 070 520	1	23	1.7	0.4	yes	Reverse crimp
RG174 / RG316	2.6/50/S	R141 075 000	2	30.3	1.8	0.6		
		R141 075 161						
		R141A 075 161	3	26	1.7	0.6		Commercial version
	3.8/93/S	R141 077 000	2	28	2.7	0.4		
RG58 / RG14	5/50/S	R141 072 000	4	39	3.1	1		
		R141 082 000	5	28				Single piece body Commercial version
		R141 082 161	3					
		R141A 082 161		30				
RG142 / RG223 / RG400	5/50/D	R141 083 000	5	28	3	1.05		Single piece body

Right angle plugs and straight jacks

RIGHT ANGLE PLUGS CLAMP TYPE FOR FLEXIBLE CABLES

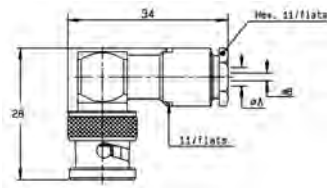

Fig. 1

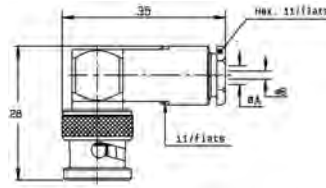

Fig. 2

Cable group	Cable group dia.	Part number	Fig.	Dimensions (mm)		Captive center contact	Note
				A	B		
RG178 / RG196	2/50	R141 153 000	1	2.2	0.6	yes	100 pieces
RG174 / RG316 / RD316 / RG179	2.6/50+75/S+D	R141 154 000		3.1			
RG58 / RG141 / RG142 / RG223 / RG400	5/50/S + D	R141 156 000	2	5.6	1.05		Unit packaging

RIGHT ANGLE PLUGS FULL CRIMP TYPE FOR FLEXIBLE CABLES

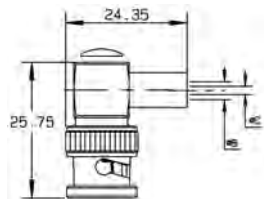

Fig. 1

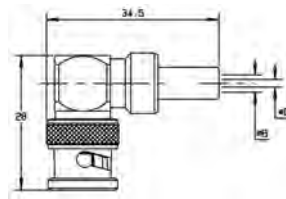

Fig. 2

Cable group	Cable group dia.	Part number	Fig.	Dimensions (mm)		Captive center contact	Note
				B	C		
RG174 / RG316	2.6/50/S	R141 181 161	1	3.25	1.7	yes	Commercial version
		R141 182 000	2	5.5	1.05		Single piece body
RG58 / RG141	5/50/S	R141 182 161	1	5.5	3.15	yes	Commercial version
		R141 182 177	2	5.55	3.2		Non magnetic
RG142 / RG223 / RG400	5/50/D	R141 183 000			5.8	1.05	

STRAIGHT JACKS FOR FLEXIBLE CABLES

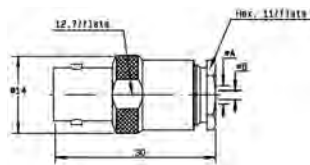

Fig. 1

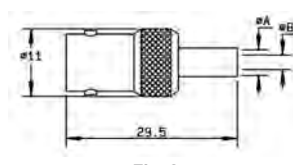

Fig. 2

Cable group	Cable group dia.	Part number	Fig.	Dimensions (mm)		Captive center contact	Note
				A	B		
RG58 / RG141 / RG142 / RG223 / RG400	5/50/S + D	R141 207 000	1	5.6	1.05	no	Clamp type
		R141 208 000					
RG174 / RG316	2.6/50/S	R141 217 000	2	5.5	1.05	yes	Full crimp type
RG58 / RG141	5/50/S	R141 237 000					Single piece body, full crimp type
		R141 237 161					Commercial version, full crimp type
RG142 / RG223 / RG400	5/50/D	R141 220 000					Single piece body, full crimp type

Square flange jacks

STRAIGHT SQUARE FLANGE JACKS CLAMP TYPE FOR FLEXIBLE CABLES

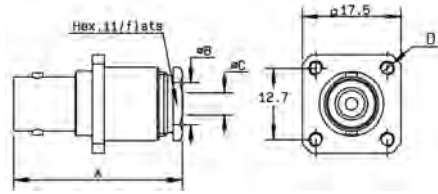

Fig. 1

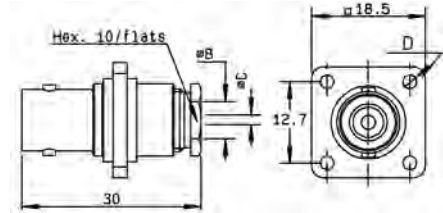

Fig. 2

Cable group	Cable group dia.	Part number	Fig.	Dimensions (mm)				Captive center contact	Panel drilling	Note
				A	B	C	D			
RG178 / RG196	2/50/S + D	R141 253 000	1	29.5	2.2	0.6	3-56-UNF-2B	yes	P01	
RG174 / RG316 / RD316 / RG179	2.6/50+75/S+D	R141 254 000			3.1					
		R141 278 000			2.7					
RG58 / RG141	5/50/S	R141 277 000	2	3		2.6		P01	Insulated flange	
		R141 257 000	1	30	5.6	1.05	2.5	no	P01	
RG58 / RG141 / RG142 / RG223 / RG400	5/50/S + D	R141 256 000	2		5.6	1.05	2.6		P02	Insulated flange
		R141 258 000	1	30	5.6	1.05	3-56-UNF-2B	P01	Unit packaging	
RG59	6/75	R141 261 000		30	6.5	1	2.5	P10		

STRAIGHT SQUARE FLANGE JACKS FULL CRIMP TYPE FOR FLEXIBLE CABLES

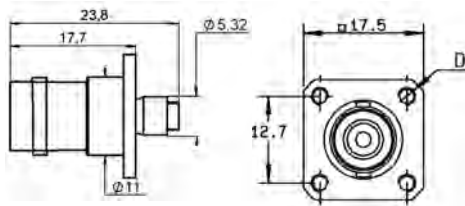

Fig. 1

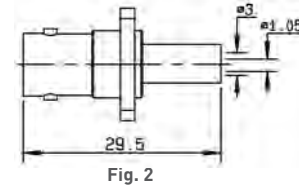
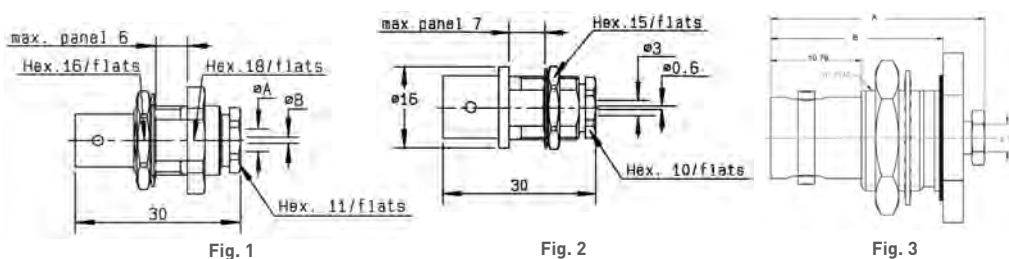

Fig. 2

Cable group	Cable group dia.	Part number	Fig.	Dimensions D (mm)	Captive center contact	Panel drilling	Note
RG174 / RG316	2.6/50	R141 290 200	1	M3 x 0.5	yes	P04	Reverse crimping, Unit packaging
RG58 / RG141	5/50/S	R141 292 000	2	3 x 56 UNEF 2B		P17	Single piece body

Bulkhead jacks

STRAIGHT BULKHEAD JACKS CLAMP TYPE



Cable group	Cable group dia.	Part number	Fig.	Dimensions (mm)		Captive center contact	Panel drilling	Note
				A	B			
RG178 / RG196	2/50/S	R141 323 000	1	2.2	0.6	yes	P11	Panel sealed
RG174 / RG316 / RD316 / RG179	2.6/50+75/S+D	R141 304 000	2	3.1	0.6			Panel sealed
		R141 324 000	1	3.1	0.6			Totally sealed
RG174 / RG316 / RD316	2.6/50/S + D	R141 324 200	1	5.6	1.05	no	Panel sealed	
RG401	.141"	R141 338 007	1	3.68	1.27	yes	P11	Panel sealed, non magnetic
		R141 338 000		3.65	1.05	no		Panel sealed
RG174 / RG316 / RG179	2.6/50+75S	6501-6571-103	3	27.42	20.98	yes	P11	Panel sealed
RD316	2.6/50D	6501-7551-219		25.4	20.47			

STRAIGHT BULKHEAD JACKS CRIMP TYPE FOR FLEXIBLE CABLES

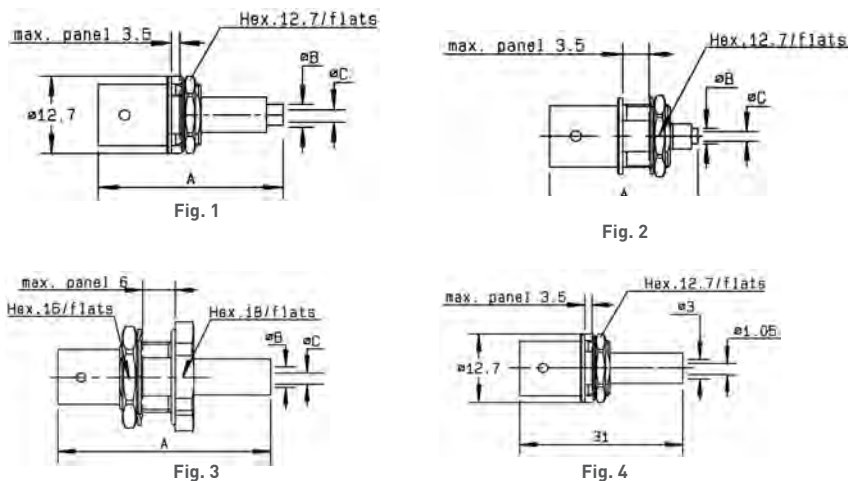

Cable group	Cable group dia.	Part number	Fig.	Dimensions (mm)			Captive center contact	Panel drilling	Note
				A	B	C			
RG178	2/50S	R141 303 503	2	26.4	2	0.4	yes	P14	Reverse crimping/ commercial version
RD178	2/50D	R141 301 000	1	33.35	1.09	0.6			Reverse crimping/ commercial version
RG174 / RG316	2.6/50/S	R141 306 000	1	34	1.7	0.6	no	P11 or P16	Panel sealed
		R141 306 503	2	26	2.95				ECO version
		R141 331 500	3	38.5	1.7				Single piece body
RG58 / RG141	5/50/S	R141 308 000	4	35.5	3.1	1.05	yes	P11 or P16	Panel sealed single piece body
		R141 332 500	3						

Flange receptacles

FLANGE RECEPTACLES

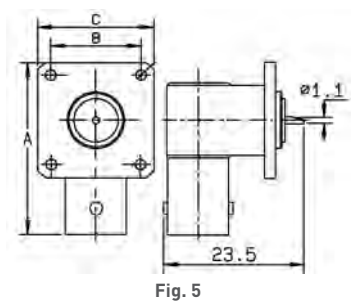
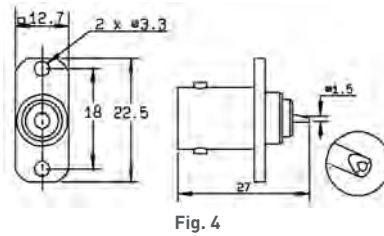
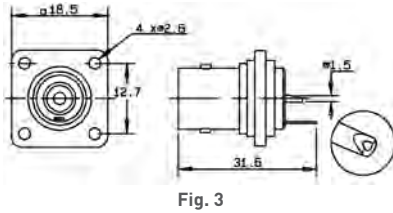
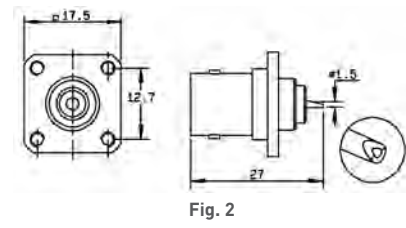
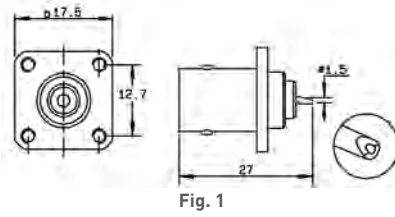

Part number	Fig.	Dimensions (mm)			Captive center contact	Panel drilling	Flange holes	Note
		A	B	C				
R141 403 000	1				yes	P07	4 x M2.5	
R141 404 000	2					P06		
R141 406 000	1					P07	4 x M2.6	
R141 407 000	2					P06		
R141 410 000	3					P02		Insulated flange/solder tag
R141 453 000	4					P18		2 hole flange
R141 654 000	5	26.9	12.7	17.5		P05	4 x M2.6	Right angle receptacle

Bulkhead receptacles

RIGHT ANGLE BULKHEAD RECEPTACLE WITH SOLDER POT

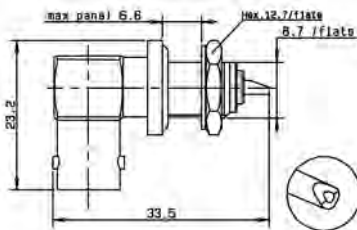

Part number	Captive center contact	Panel drilling
R141 680 000	yes	P14

Bulkhead receptacles

STRAIGHT BULKHEAD RECEPTACLES WITH SOLDER POT

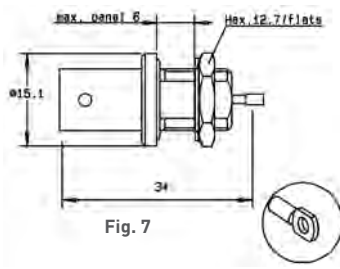
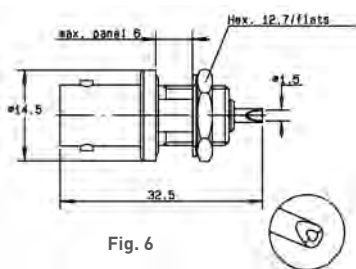
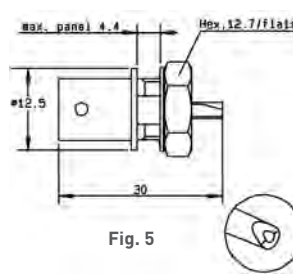
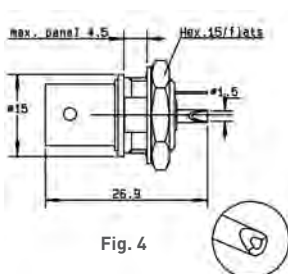
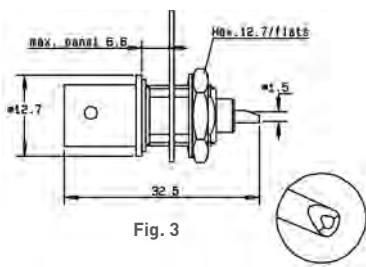
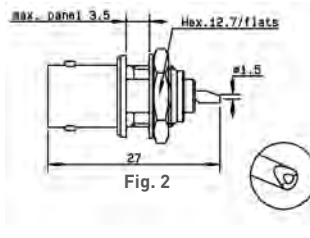
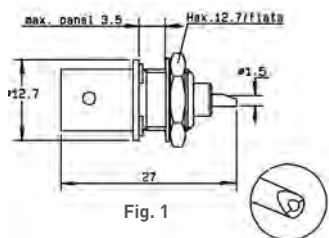

Part number	Fig.	A (Length)	Captive center contact	Panel drilling	Note
R141 554 000	1		yes	P12	
R141 557 000	2			P14	Solder tag
R141 559 000	3				Silver plated center contact/ commercial version
R141 563 161	2			P11	Insulated receptacle + solder tag
R141 572 000	4			P14	Commercial version/insulated
R141 574 000	5				Fully sealed/Q200-5 insulator
R141 574 161	5				Fully sealed
R141 603 000	6			P15	Not sealed/ECO version
R141 605 000					Hermetically sealed
R141A 605 000	3	28			P21
R141 625 000	7			P14	

Receptacles

RECEPTACLES

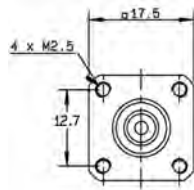

Fig. 1

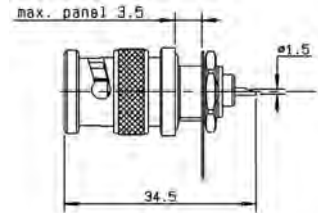
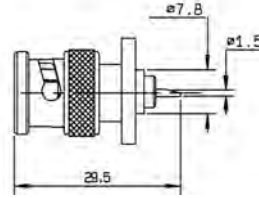

Fig. 2

Part number	Fig.	Captive center contact	Panel drilling	Note
R141 440 000	1	yes	P03	Male square flange
R141 580 000	2		P14	Male bulkhead / Panel sealed / Solder tag

STRAIGHT PCB FEMALE RECEPTACLES

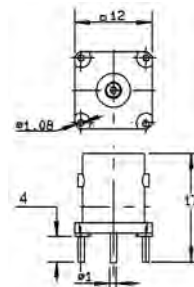

Fig. 1

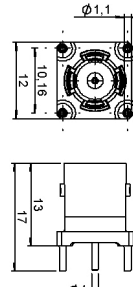

Fig. 2

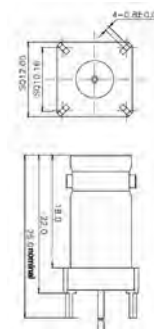

Fig. 3

Part number	Fig.	Captive center contact	Panel drilling	Note
R141 426 000	1	yes	P08	Die cast body / Commercial version
R141 426 161	2			
R141 426 168	3			

RIGHT ANGLE PCB FEMALE RECEPTACLES

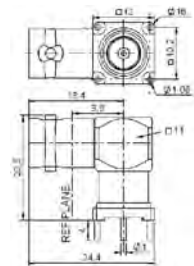

Fig. 1

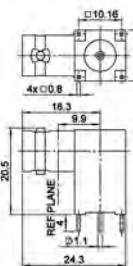
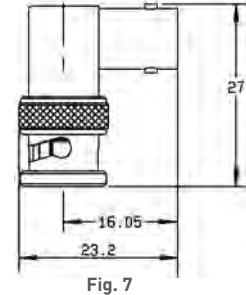
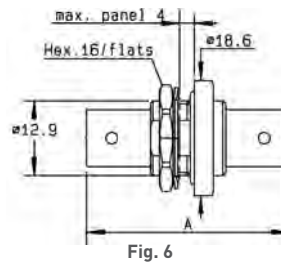
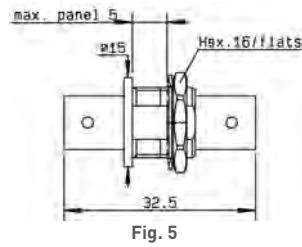
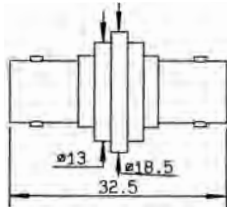
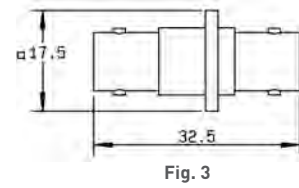
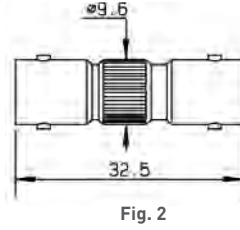
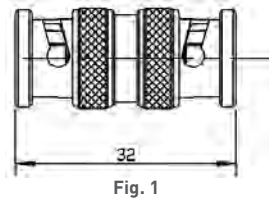

Fig. 2

Part number	Fig.	Captive center contact	Panel drilling	Finish	Note
R141 665 000	1	yes	P19	Nickel	
R141 665 200	2		P08		

Adapters

IN SERIES ADAPTERS



Part number	Fig.	Captive center contact	Dimension A (mm)	Flange holes	Panel drilling	Note	
R141 703 000	1	yes				male - male	
R141 704 000	2					female - female	
R141 710 000	3				4 x M2.5	P10	female - female square flange
R141 717 000	4				4 x 2.6	P02	female - female square insulated flange
R141 720 000	5					P13	female - female bulkhead
R141A 720 000							female - female bulkhead/ECO version
R141 723 000						P13 or P16	female - female insulated bulkhead
R141 723 161							female - female insulated bulkhead/commercial version
R141 730 000	6			35.7		P13	female - female panel sealed bulkhead
R141 753 000				35.3			female - female hermetically sealed bulkhead
R141 770 000	7					male - female right angle	

Adapters and caps

CROSS AND TEE IN SERIES ADAPTERS

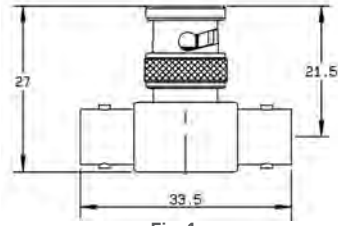

Fig. 1

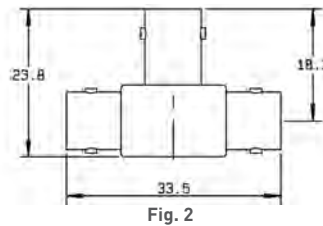

Fig. 2

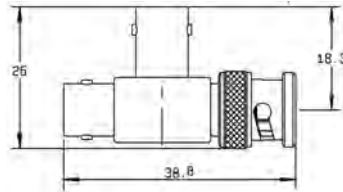

Fig. 3

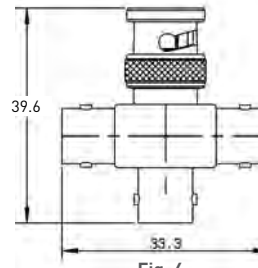

Fig. 4

Part number	Fig.	Captive center contact	Note
R141 780 000	1	yes	male/female-female tee
R141 782 000	2		female/female-female tee
R141 789 000	3		female/female-male tee
R141 799 000	4		male/female-female-female cross/unit packaging

MALE AND FEMALE CAPS

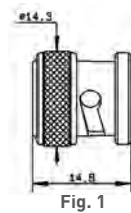

Fig. 1



Fig. 2

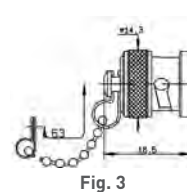

Fig. 3

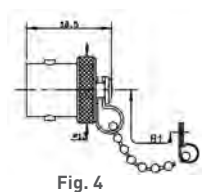

Fig. 4



Part number	Fig.	Note
R141 802 000	1	male
R141 805 000	2	male with cord
R141 812 000	3	male with chain
R141 842 000	4	female with chain
R141 862 000	3	male short circuit / with chain

Straight plugs

STRAIGHT PLUGS CLAMP TYPE FOR FLEXIBLE CABLES

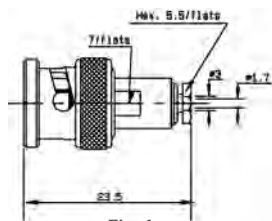

Fig. 1

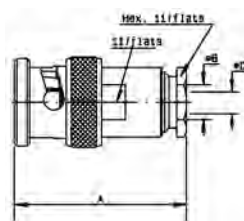

Fig. 2

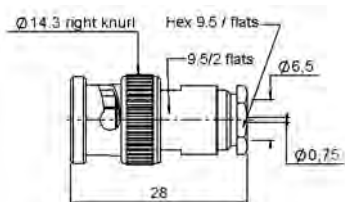

Fig. 3

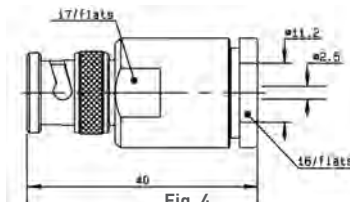

Fig. 4

Cable group	Cable group dia.	Part number	Fig.	Dimensions (mm)			Captive center contact	Note	
				A	B	C			
RG179	2.6/75/S	R142 004 000	1				yes		
RG59 / RG62	6/75/S	R142 016 000	2	28	6.6	0.75			Unit packaging
		R142 016 161	3						Commercial version
RG6A / U	8/75/S + D	R142 017 000	2	45.5	9.1	1.5		Unit packaging	
RG216 / RG11 / RG12 / RG144	10 + 11/75/S + D	R142 018 000	4				yes		
RG6A / U	GORE cable	6500-7071-046	2	23.87	4.31	2.79			

STRAIGHT PLUGS FULL CRIMP TYPE FOR FLEXIBLE CABLES

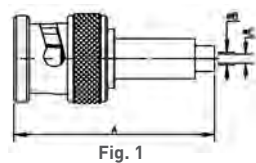

Fig. 1

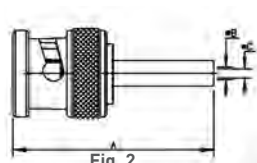

Fig. 2

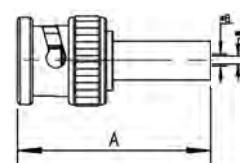
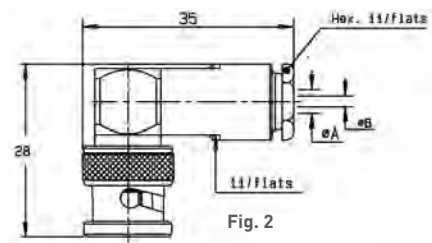
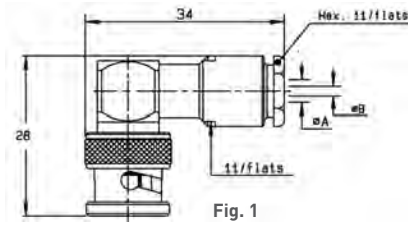

Fig. 3

Cable group	Cable group dia.	Part number	Fig.	Dimensions (mm)			Captive center contact	Note	
				A	B	C			
RG179	2.6/75/S	R142 076 000	1	31	1.8	0.4	yes		
		R142 076 161	3						Commercial version
		R142A 076 161						25.3	1.65
BT3002	3.6/75/D	R142 081 120	2	29	2.1	0.34		Single piece body	
		R142 081 130		29	2.1	0.34		Single piece body / unit packaging	
		R142A 081 130		29	2.1	0.34		Single piece body / ECO version	
ST212		R142 091 161	3	30	2.1	0.6	yes		
BT2002	5/75/D	R142 083 000	2	27.3	5.5	0.75		Single piece body	
		R142 085 000		28	6.6				
RG59 / RG62	6/75/S	R142 085 161	3	28	3.9	0.8	no	Single piece body / Commercial version	
		R142A 085 161		29	4			0.8	Single piece body / ECO version
			7/75/S	R142 086 161	2	30.8	5.15	1.35	
RG11 / RG12 / RG144	7.5/75/D	R142 090 000	2	28	5.25	0.85	yes	Single piece body	
	10/75/S	R142 095 000		28	11.05	1.35			

Right angle plugs and jacks

RIGHT ANGLE PLUGS CLAMP TYPE FOR FLEXIBLE CABLES



Cable group	Cable group dia.	Part number	Fig.	Dimensions (mm)		Captive center contact
				A	B	
RG179	2.6/75/S	R142 154 000	1	3.1	0.6	yes
RG59 / RG62	6/75/S	R142 157 000	2	6.6	0.75	

RIGHT ANGLE PLUGS FULL CRIMP TYPE FOR FLEXIBLE CABLES

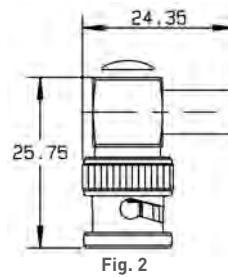
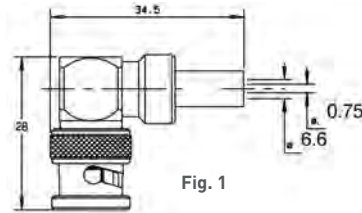

Cable group	Cable group dia.	Part number	Fig.	Captive center contact	Note
RG59 / RG62	6/75/S	R142 184 000	1	yes	
		R142 184 161	2		Commercial version

STRAIGHT JACKS FULL CRIMP TYPE FOR FLEXIBLE CABLES

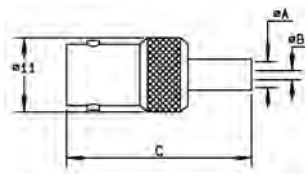

Cable group	Cable group dia.	Part number	Dimensions (mm)			Captive center contact	Note
			A	B	C		
RG179	2.6/75/S	R142 217 000	1.75	0.4	32.5	yes	
RG59 / RG62	6/75/S	R142 242 000	6.6	0.75	29.5		Single piece body
		R142 242 161			29		Single piece body/commercial version

Jacks and bulkhead jacks

STRAIGHT SQUARE FLANGE JACKS CLAMP TYPE FOR FLEXIBLE CABLES

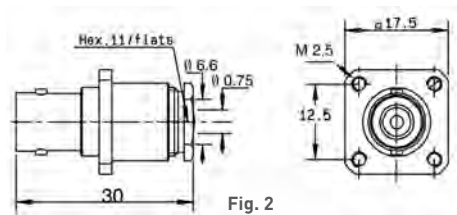
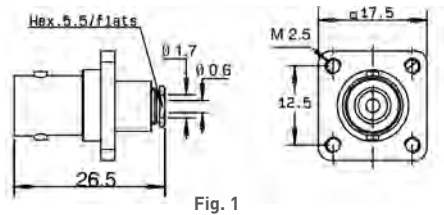

Cable group	Cable group dia.	Part number	Fig.	Captive center contact	Panel drilling	Note
RG179	2.6/75/S	R142 202 000	1	yes	P01	Unit packaging
RG59 / RG62	6/75/S	R142 268 000	2			

STRAIGHT BULKHEAD JACK CLAMP TYPE FOR FLEXIBLE CABLES

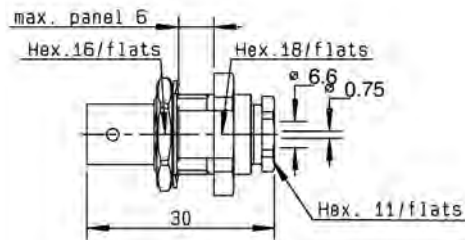

Cable group	Cable group dia.	Part number	Captive center contact	Panel drilling	Note
RG59 / RG62	6/75/S	R142 329 000	yes	P11	Panel sealed

STRAIGHT BULKHEAD JACKS CRIMP TYPE FOR FLEXIBLE CABLES

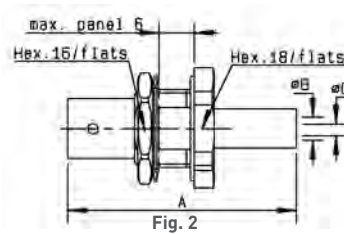
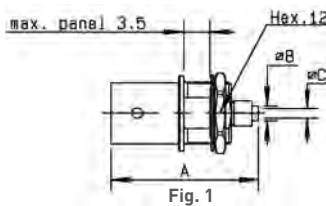

Cable group	Cable group dia.	Part number	Fig.	Dimensions (mm)			Captive center contact	Panel drilling	Note			
				A	B	C						
RG179	2.6/75/S	R142 306 500	1	26	2.95	0.4	yes	P14	Reverse crimping/Commercial version			
		R142A 306 500					no		Reverse crimping/ECO version			
		R142 306 503					yes		Reverse crimping			
		R142 331 011										
BT3002	3.6/75/D	R142A 325 106	2	36	2.1	0.5	no	P11 or P16	Panel sealed/Silver plated			
RG59 / RG62	6/75/S	R142 334 161					yes		35	6.6	0.75	Panel sealed/Commercial version
		R142A 334 161					yes		35	3.8	0.7	Panel sealed/ECO version

Receptacles

RECEPTACLES WITH SOLDER POT

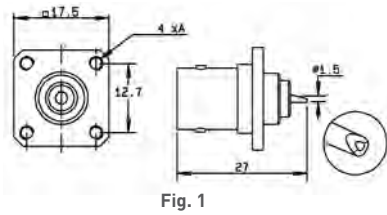

Fig. 1

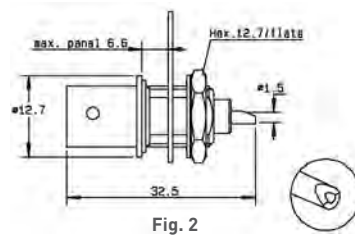
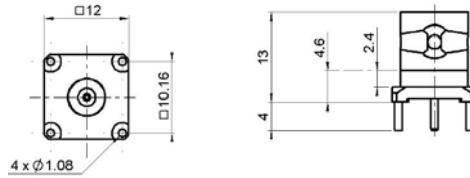

Fig. 2



Part number	Fig.	Captive center contact	Panel drilling	Flange holes A	Note
R142 412 000	1	yes	P06	4 x M2.5	Square flange + unit packaging
R142 562 000	2		P14		Bulkhead female receptacle Unit packaging

STRAIGHT PCB FEMALE RECEPTACLES



Part number	Captive center contact	Panel drilling
R142 426 000	yes	P08

RIGHT ANGLE PCB FEMALE RECEPTACLE

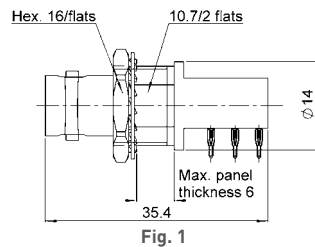

Fig. 1

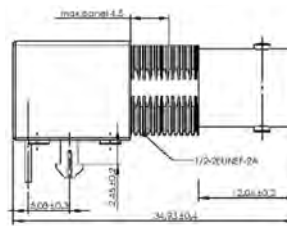

Fig. 2

Part number	Fig.	Captive center contact	Panel drilling	Note
R142 684 130	1	yes	P09 and P16	Press-fit pins
R142 676 430	2		yes	Harpoon legs

Adapters

IN SERIES ADAPTERS

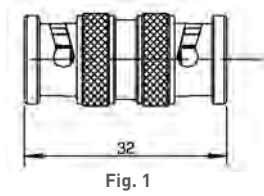

Fig. 1

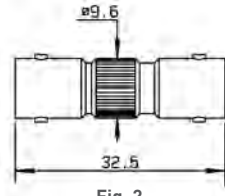

Fig. 2

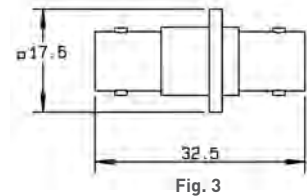

Fig. 3

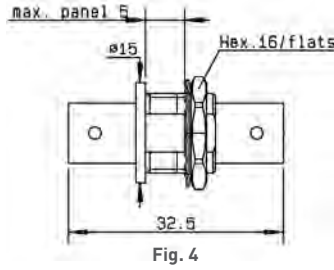

Fig. 4

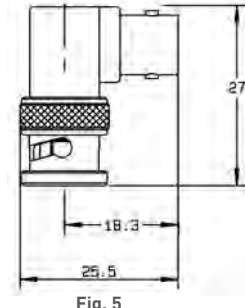

Fig. 5

Part number	Fig.	Captive center contact	Panel drilling	Note
R142 703 000	1	yes		male - male
R142 704 000	2			female - female
R142 710 000	3		P01	female - female square flange
R142 720 000	4		P11	female - female bulkhead
R142 723 000	4		P11 or P16	female - female insulated bulkhead
R142 770 000	5			male - female right angle

TEE IN SERIES ADAPTERS

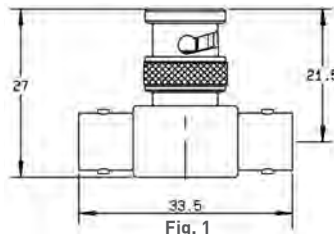

Fig. 1

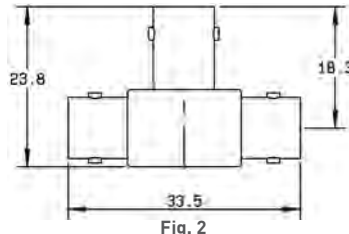

Fig. 2

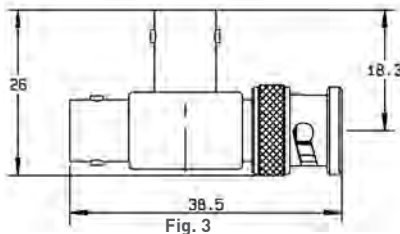

Fig. 3

Part number	Fig.	Captive center contact	Note
R142 780 000	1	yes	male / female-female tee
R142 782 000	2		female / female-female tee
R142 789 000	3		female / female-male tee

Characteristics

Test / Characteristics	Values / Remarks	
Frequency range	DC - 10 GHz	
Impedance	50Ω	
Working voltage	500 Vrms	
Dielectric withstanding voltage <ul style="list-style-type: none"> • Between center conductor and inner screen • Between inner screen and outer screen 	Unmated connector 1500 Vrms 1000 Vrms	Mated connector 3000 Vrms 1000 Vrms
Temperature range	-55°C / +125°C	

Plug, jack and receptacle

STRAIGHT PLUG CLAMP TYPE

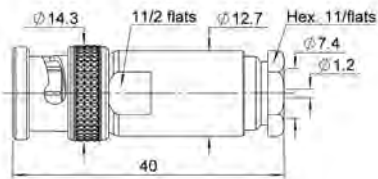

Cable group dia.	Part number
7.3 / 50 / D	R266 010 000

STRAIGHT JACK CLAMP TYPE

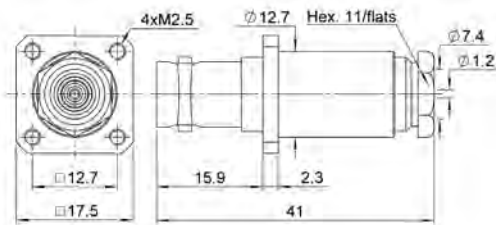

Cable group dia.	Part number	Panel Drilling
7.3 / 50 / D	R266 260 000	P10

RECEPTACLE

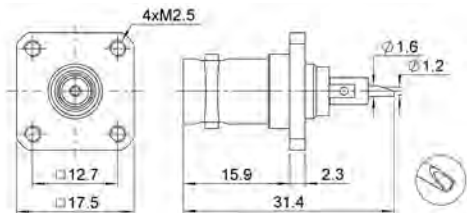

Part number	Panel Drilling
R266 403 000	P10

Panel drilling

P01

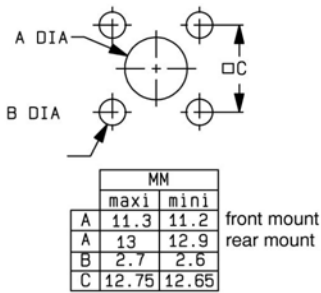

P02

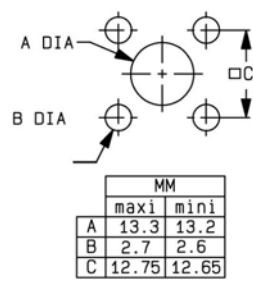

P03

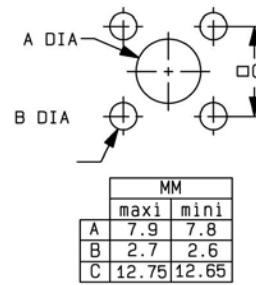

P04

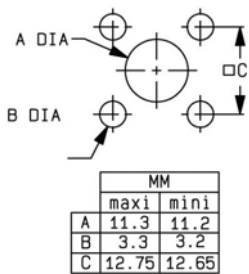

P05

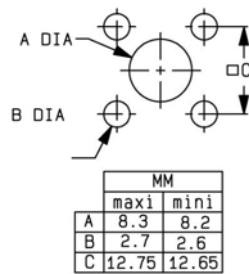

P06

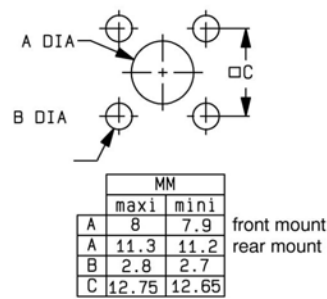

P07

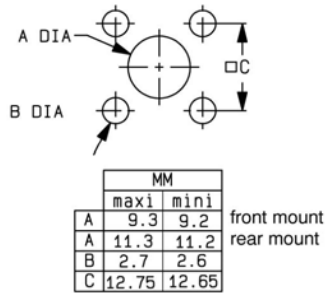

P08

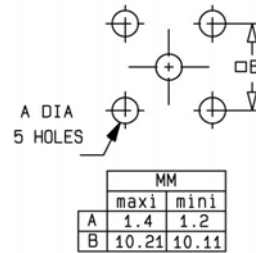

P09

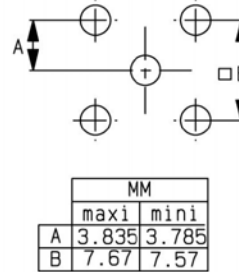

P10

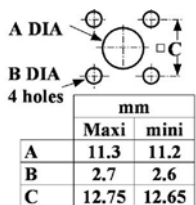

P11

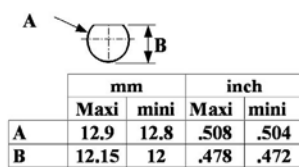

P12

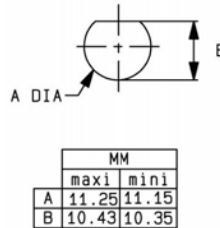

Panel drilling

P13

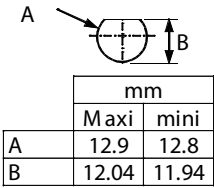

P14

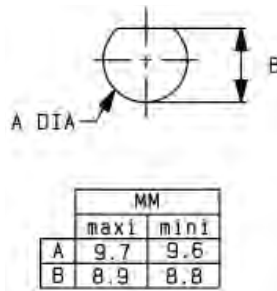

P15



P16

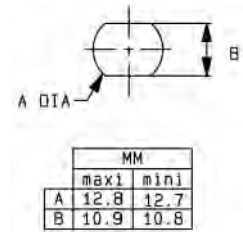

P17

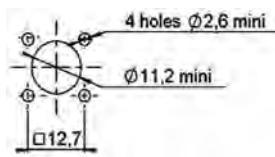

P18



P19

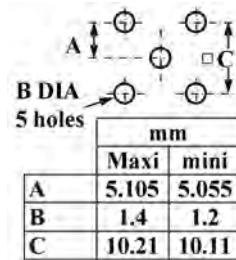

P20

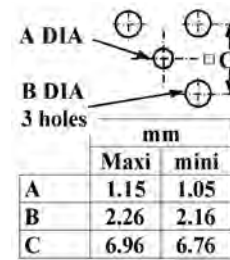

P21

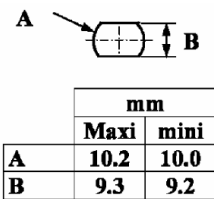



**High Frequency Connectors: N 18 GHz
TNC 18 GHz / SMA 2.9 / 2.4 mm**

R163 / R143 / R127 / R327



Contents

N 18 GHz

Introduction..... 10-4 to 10-5
Interface 10-6
Characteristics 10-7
Plugs and jacks..... 10-8
Adapters 10-8

TNC 18 GHz

Interface 10-9
Characteristics 10-10
Plugs 10-11
Jacks 10-11 to 10-12
Receptacles..... 10-12
Adapters 10-13
Caps 10-13

SMA 2.9

Introduction..... 10-14
Interface 10-15
Characteristics and plugs 10-16
Jacks and receptacles 10-17
Glass bead 10-18
In series adapters 10-18
Between series adapters 10-19
Panel drilling 10-19

2.4 MM

Interface 10-20
Characteristics 10-21
Plugs, jacks and receptacles 10-22 to 10-23
Glass bead 10-23
In series adapters 10-24
Panel drilling 10-24

Introduction

N 18 connectors are 50 ohm precision N Type connectors designed to perform through 18 GHz. N connectors are a popular medium sized option commonly used in microwave and RF applications that require high power handling and good electrical performance. Radiall Type N connector interfaces utilizes a PTFE (Teflon) dielectric. The male connectors are provided with a 19 mm (3/4 in.) hex coupling nut so they can be properly torqued. Connector bodies are made from stainless steel, and contacts are made from gold plated and heat treated beryllium copper contacts to insure long life and reliability.

Radiall offers N connectors for semi-rigid and low loss flexible cables, receptacles and precision adapters.

Connectors for low loss flexible cables and TestPro cables are not detailed in this section. They are available in our cable assembly offer.



TYPE N 18 DESIGN FEATURES:

- Excellent performance up to 18 GHz
- Low VSWR and insertion loss
- Highly robust construction for reliability
- Superior interface environmental seal
- High power capability

Interface

N 18 GHz

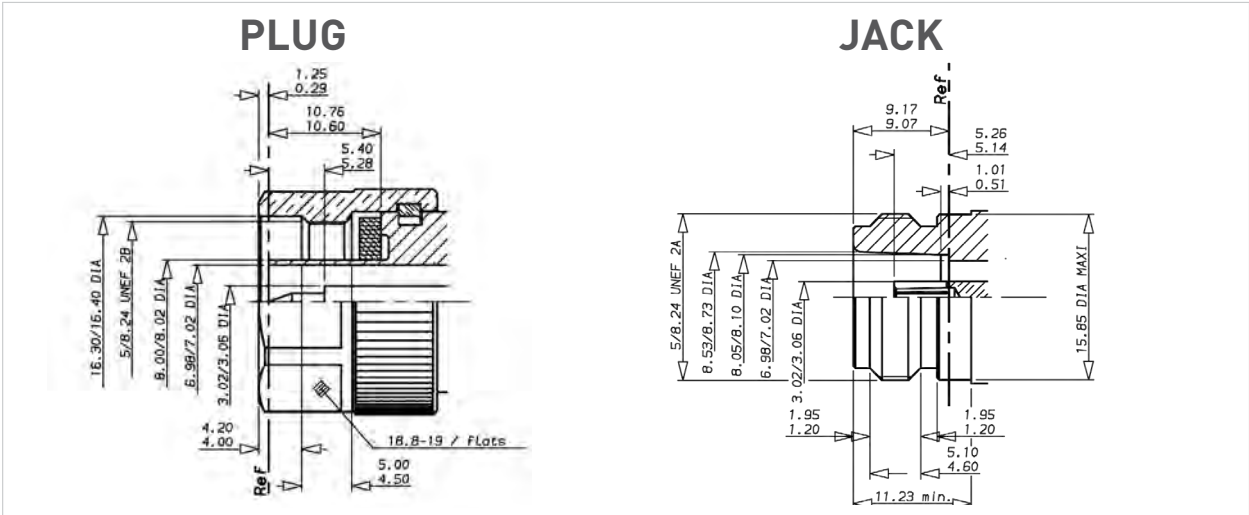

IMPORTANT: the 50Ω and the 75Ω connectors are **NOT INTERMATEABLE**, results in the interface destruction.

mm	inch
0.29	.0114
1.25	.049
3.02	.1189
3.06	.1204
4.00	.157
4.20	.165
4.50	.177
5.00	.197
5.28	.208
5.40	.2126
6.98	.2748
7.02	.2764
8.00	.315
8.02	.316
10.60	.417
10.76	.423
16.30	.642
16.40	.646
18.80	.740
19.00	.748

mm	inch
0.51	.020
1.01	.0397
1.20	.0472
1.95	.0767
3.02	.1189
3.06	.1204
4.60	.1811
5.10	.201
5.14	.202
5.26	.207
6.98	.2748
7.02	.2764
8.05	.317
8.10	.319
8.73	.3437
9.07	.357
9.17	.361
11.23	.442
15.85	.624

Mating dimensions are MIL-C-39012 nominal with tighter tolerances and solid outer contact.

Characteristics

Test/Characteristics	Values/Remarks
----------------------	----------------

ELECTRICAL CHARACTERISTICS

Impedance	50Ω	
Frequency range	DC - 18 GHz	
Typical V.S.W.R. • Straight connector • Right angle connector	With SHF cables 1.10 at 18 GHz 1.15 at 18 GHz	
Insertion loss	< 0.1 √F [GHz] dB	
RF Leakage	- 90 dB (2 to 3 GHz)	
Insulation resistance	5000 MΩ min	
Contact resistance • Outer contact • Inner contact	After environment test 2 mΩ max N.A.	Initial 1.5 mΩ max 2 mΩ max
Peak power (at sea level)	5000 W	
Average power (at sea level, 25°C)	2000 W at 0.1 GHz 600 W at 1 GHz 150 W at 10 GHz	
	.085" semi-rigid cable	.141" semi-rigid cable
Dielectric withstanding voltage • At sea level • At 70 000 feet	1000 Vrms 250 Vrms	1500 Vrms 375 Vrms
Voltage rating • At sea level • At 70 000 feet	335 Vrms 85 Vrms	500 Vrms 125 Vrms
RF high potential withstanding voltage	670 Vrms	1000 Vrms
Corona level	250 Vrms	375 Vrms

MECHANICAL CHARACTERISTICS

Durability	500 matings	
Cable retention force	136 N (31 lbf)	272 N (61 lbf)
Recommended coupling torque	160 Ncm (14 lbf.in)	
Contact captivation	27 Ncm (6 lbf) min	

ENVIRONMENTAL CHARACTERISTICS

Temperature range	Standard connectors - 65°C + 165°C	Connectors for semi-rigid cable - 40°C + 125°C
Vibration	MIL-STD-1344 Method 2005 Condition 4	
Shock	MIL-STD-1344 Method 2004 Condition G	
Thermal shock	MIL-STD-1344 Method 1003 Condition A	
Corrosion (salt mist)	MIL-STD-1344 Method 1001 Condition B	
High temperature test	CECC 22000/4.7.2	
Damp heat	CECC 22000/4.6.6	
Low pressure immersion	EN2591 AECMA TestC14	
Resistance to fluids contamination	EN2591 AECMA TestC15	

MATERIALS

Body	Stainless steel
Center contact	Beryllium copper and brass
Coupling nut	Brass
Insulator	PTFE or polyetherimid resin
Gasket	Fluorosilicon or fluorocarbon

PLATING

Body	Passivated
Center contact	Gold
Coupling nut	Nickel

Plugs, jacks and adapters

STRAIGHT PLUGS FOR SEMI-RIGID CABLES

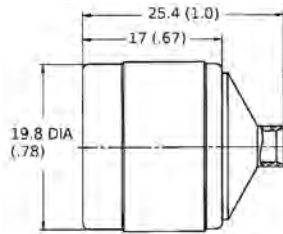

Cable group	Cable group dia.	Part number	Captive center contact	Material	Note
RG402	.141"	4000-1563-009	yes	Stainless steel	Direct solder
RG405	.085"	4000-1563-010			

Note:
N18 GHz plugs for SHF high frequency flexible cable are available as cable assemblies only. Consult us for standard N18 GHz cable assembly part numbers.

BULKHEAD STRAIGHT JACKS, FOR SEMI-RIGID CABLES (panel sealed)

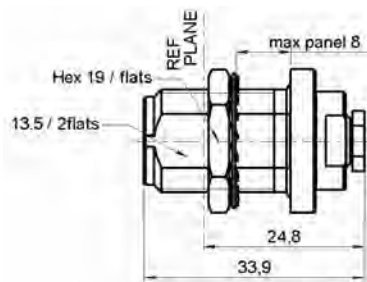

Cable group	Cable group dia.	Part number	Captive center contact	Panel drilling	Material	Note
RG405	.085"	4501-9543-010	yes	P14	Stainless steel	Solder clamp/ rear mount
RG402	.141"	4501-9543-009				
		R163 337 001				

IN SERIES ADAPTERS



Fig. 1

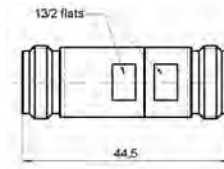

Fig. 2

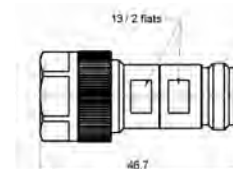

Fig. 3

Part number	Fig.	Dimension (mm)	Note
R163 703 001	1	53.5 (2.106)	male-male
R163 705 001	2	44.5 (1.752)	female-female
R163 708 001	3	46.7 (1.838)	male-female

Note:
7mm air line adapters also available upon request.

Introduction

TNC 18 connectors are 50 ohm precision TNC Type connectors designed to perform through 18 GHz. TNC connectors are a popular medium sized option commonly used in microwave and RF applications that require average power handling and good electrical performance. Radiall TNC connector interfaces utilize a PTFE (Teflon) dielectric. The male connectors are provided with a 14 mm (9/16 in.) hex coupling nut so they can be properly torqued. Connector bodies are made from stainless steel, and contacts are made from gold plated and heat treated beryllium copper contacts to insure long life and reliability.

Radiall offers TNC connectors for semi-rigid and low loss flexible cables, receptacles and precision adapters.

Connectors for low loss flexible cables and TestPro cables are not detailed in this section. They are available in our cable assembly offer.

TNC 18 DESIGN FEATURES

- Excellent performance up to 18 GHz
- Low VSWR and insertion loss
- Rugged construction for reliability
- Superior interface environmental seal
- Medium power capability

Interface

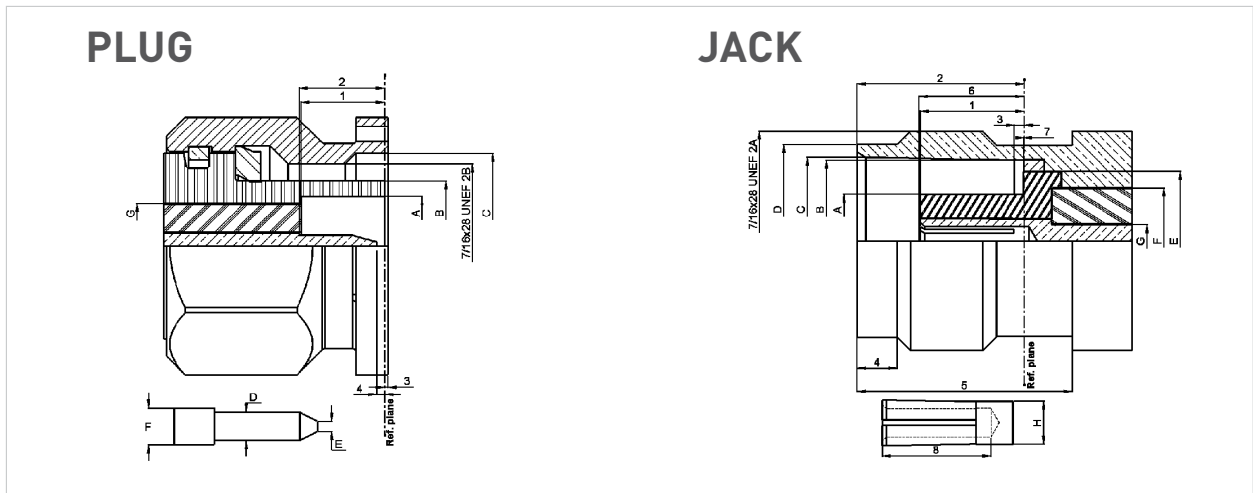

Letter	mm		inch	
	min.	max.	min.	max.
A	6.18	6.22	0.243	0.245
B	8.03	8.09	0.316	0.319
C	11.40	11.60	0.449	0.457
D	1.34	1.36	0.053	0.054
E	0.35	0.65	0.014	0.026
F	1.62	1.66	0.064	0.065
G	5.28	5.32	0.208	0.210
1	5.28	5.38	0.208	0.212
2	5.35	5.50	0.211	0.217
3	-0.30	0.55	-0.012	0.022
4	0.35	0.90	0.014	0.065

Letter	mm		inch	
	min.	max.	min.	max.
A	4.68	4.72	0.184	0.186
B	8.10	8.15	0.319	0.321
C	8.32	8.46	0.328	0.333
D	9.61	9.68	0.379	0.381
E	6.93	6.98	0.273	0.275
F	5.28	5.32	0.208	0.210
G	1.62	1.66	0.064	0.065
H	2.14	2.18	0.084	0.086
1	4.98	5.23	0.196	0.206
2	8.36	8.46	0.329	0.333
3	0.48	1.02	0.019	0.040
4	1.80	2.20	0.071	0.087
5	10.60	11.00	0.417	0.432
6	5.18	5.28	0.204	0.208
7	-0.10	0.05	0.004	0.002
8	5.20	5.70	0.204	0.224

Characteristics

Test / Characteristics	MIL-C-39012 A	Values / Remarks
------------------------	---------------	------------------

ELECTRICAL CHARACTERISTICS

Impedance		50Ω
Frequency range		DC - 18 GHz
V.S.W.R.	3-14	Semi-rigid cable: 1.17 max Flexible cable: 1.35 at 12.4 GHz In series adapter: 1.35 max
Insertion loss	3-27	0.18 dB max at 9 GHz
RF leakage	3-26	-60 dB min from 2 to 3 GHz
Insulation resistance	3-11	5000 MΩ min
Contact resistance	3-16	Initial 1.5 0.2
• Center contact (mΩ)		After proof 2 -
• Outer contact (mΩ)		
Working voltage		At sea level: 500 V rms at 70000 ft (21000 m): 125 V rms
Dielectric withstanding voltage	3-17	At sea level: 1500 V rms at 70000 ft (21000 m): 375 V rms
RF withstanding voltage	3-23	At sea level: 1000 V rms [5 MHz sine wave]

MECHANICAL CHARACTERISTICS

Durability	3-15	500 matings
Mating / unmating		axial force: not applicable torque: 1.96 inch pounds (22.6 N.cm)
Recommended mating torque		22.98 inch pounds (265 N.cm)
Proof torque		29.40 inch pounds (339 N.cm)
Coupling mechanism retention force	3-25	100 Lbf (44.5 daN)
Cabling retention force	3-24	51 Lbf (227 N min) [cable dia. .189 (4.8) to .228 (5.8)] 76.4 Lbf (340 N min) [cable dia. .250 (6.35) and above]
Center contact retention		Axial: 6.06 Lbf (27 N)

ENVIRONMENTAL CHARACTERISTICS

Temperature range		-65°C / + 165°C
• Standard models		-65°C / +100°C
• Hermetic sealed models		-65°C / +105°C
• Models for semi-rigid cables		
Combined climate tests		
Thermal shock	3-20	MIL-STD-202, method 107, condition B
High temperature endurance		MIL-STD-202, method 108
Corrosion (salt spray)	3-13	MIL-STD-202, method 101, condition B
Vibrations	3-18	MIL-STD-202, method 204, condition B
Shocks	3-19	MIL-STD-202, method 213, condition G
Moisture resistance	3-21	MIL-STD-202, method 106
Low pressure	3-22	Not applicable
Hermetic seal		Applied vacuum 10 ⁻⁶ mm of Hg (Torr) Leakage rate < 10 ⁻⁶ atm/cm ³ /s
Leakage		Pressure 3.5 bars; duration 2 mn; temperature 15°C to 25°C

MATERIALS

Body		Stainless steel
Center socket contact		Brass Bronze
• Male		
• Female		
Ferrules		Brass
Insulators		PTFE teflon
Gaskets		Silicone elastomer

PLATING

Body		Passivated
Center contacts		Gold plated

Plugs and jacks

STRAIGHT PLUGS CRIMP TYPE FOR FLEXIBLE CABLE

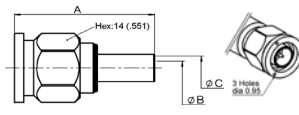

Fig. 1

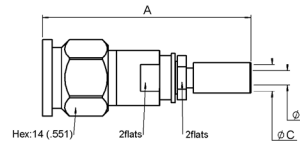
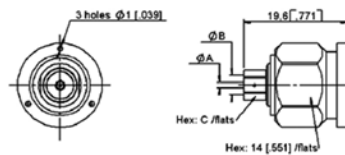

Fig. 2

Cable group	Cable group dia.	Part number	Fig.	Dimensions mm (inch)			Note
				A	B	C	
RG142 / RG223 / RG400	5/50/D	R143 082 700	1	30 [1.181]	3.2 [1.26]	5.5 [2.18]	Incl. heatshrink tube
		R143 097 700		43.5 [1.713]	3 [1.18]	5.5 [2.18]	
	3.85/50/S	R143 088 101	2	47 [1.85]	3 [1.18]	4.2 [1.65]	
	4.13/50	R143 093 700		43.5 [1.71]	2.7 [1.06]	4.5 [1.77]	
	8.07/50/S	R143 092 790		49.7 [1.957]	6.3 [2.48]	8.4 [3.31]	
RG214 / RG225	11/50/D	R143 089 700	1	35 [1.38]	7.5 [2.95]	11 [4.33]	

STRAIGHT PLUGS SOLDER TYPE FOR SEMI-RIGID CABLE



Cable group	Cable group dia.	Part number	Dimensions mm (inch)		
			A	B	C
RG402	.141"	R143 051 700	1 [.039]	3.65 [1.44]	5 [1.97]
RG401	.250"	R143 054 700	1.7 [1.067]	6.45 [2.54]	8 [3.15]

RIGHT ANGLE PLUGS CRIMP TYPE FOR FLEXIBLE CABLE

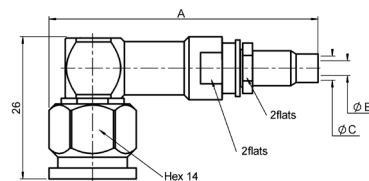

Cable group	Cable group dia.	Part number	Dimensions mm (inch)			Note
			A	B	C	
	3.85/50/S	R143 188 101	54.2 [2.13]	3 [1.18]	4.2 [1.65]	Incl. heatshrink tube
	4.13/50	R143 191 700	50 [1.97]	2.7 [1.06]	4.5 [1.77]	

Standard packaging = unit

All dimensions are given in mm (inch)

Plugs and jacks

STRAIGHT JACK SOLDER TYPE FOR SEMI-RIGID CABLE

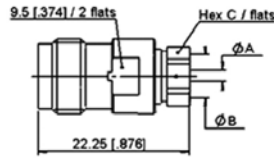

Cable group	Cable group dia.	Part number	Dimensions mm (inch)		
			A	B	C
RG402	.141"	R143 227 700	1 (.039)	3.65 (.143)	5 (.197)

STRAIGHT SQUARE FLANGE JACK CRIMP TYPE FOR FLEXIBLE CABLE

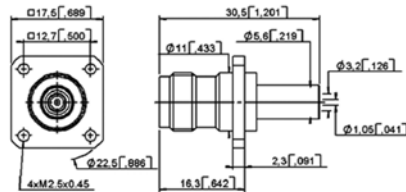

Fig. 1

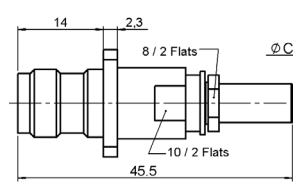
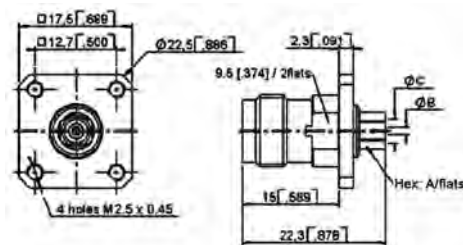

Fig. 2

Cable group	Cable group dia.	Part number	Fig.	C	Panel drilling	Note
	4.13/50	R143 295 700	2	4.4 (.173)	P01	Ind. heatshrink tube
RG142 / RG223 / RG400	5/50/D	R143 292 700	1	5.6 (.219)		
		R143 297 700	2			

STRAIGHT SQUARE FLANGE JACKS SOLDER TYPE FOR SEMI-RIGID CABLE



Cable group	Cable group dia.	Part number	Dimensions mm (inch)			Panel drilling
			A	B	C	
RG405	.085"	R143 272 700	4 (.157)	0.6 (.024)	2.25 (.089)	P12
RG402	.141"	R143 273 700	5 (.197)	1 (.039)	3.65 (.144)	
RG401	.250"	R143 274 700	8 (.315)		6.45 (.254)	

Jacks and receptacles

STRAIGHT BULKHEAD JACK PANEL SEALED

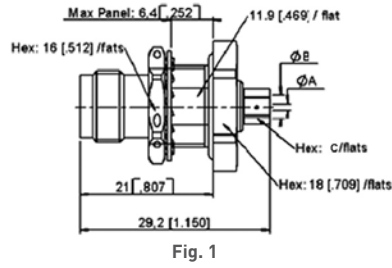

Fig. 1

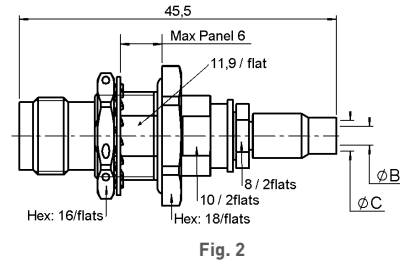
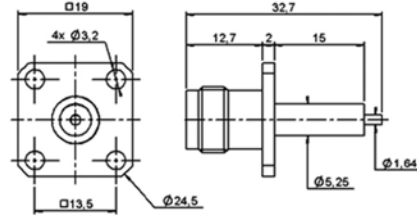

Fig. 2

Cable group	Cable group dia.	Part number	Fig.	Dimensions mm (inch)		Panel drilling	Type
				B	C		
RG402	.141"	R143 321 700	1	3.65 (.144)	5 (.197)	P09	Solder
RG401	.250"	R143 322 700		6.45	8		Crimp
	4.13/50	R143 340 700	2	2.7	4.5		

SQUARE FLANGE STRAIGHT FEMALE RECEPTACLE (extended dielectric)



Part number	Captive center contact	Panel drilling
R143 412 700	yes	P13

Adapters and caps

IN SERIES ADAPTERS

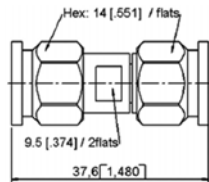

Fig. 1

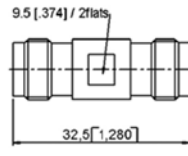

Fig. 2

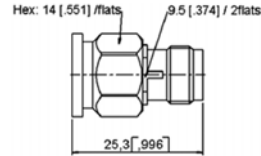

Fig. 3

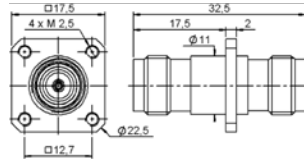

Fig. 4

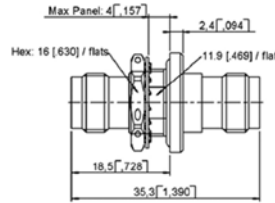
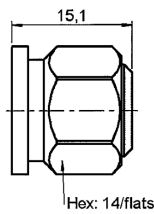

Fig. 5

Part number	Fig.	Captive center contact	Panel drilling	Note
R143 703 700	1	yes		male - male
R143 704 700	2			female - female
R143 705 700	3			male - female
R143 710 700	4		P16	Square flange female - female
R143 730 700	5		P09	Bulkhead panel sealed female - female

CAPS



Part number	Note
R143 850 700	male short circuit

Introduction

SMA 2.9 series is compatible with K® series, 2.92 mm, SMA and SMA 3.5 series, and has a shortened male center contact, ensuring a non destructive mating. Radiall offers four product variations for SMA 2.9 to meet all your needs with two different designs. The standard design is using our “ULTEM” insulator technology and is qualified up to 40 GHz. The high frequency design is using our “KAPTON” insulator technology and is qualified up to 46 GHz. All versions feature the same electrical high performance and are available in a variety of configurations.

SMA 2.9 FOR GENERAL USE, “ULTEM” TECHNOLOGY, DC-40 GHz

This robust design is suitable for most applications. The ULTEM insulator provides a high ingress protection level against chemicals, fluids or dust and is well suited for high frequency aerospace and military equipment.

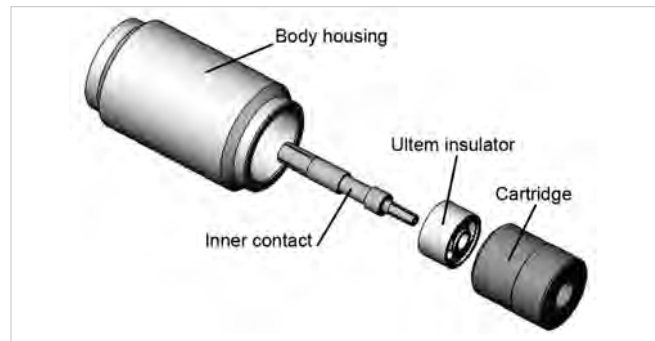

3D view of SMA 2.9 “ULTEM” design

SMA 2.9 FOR TEST LABORATORY USE, “KAPTON” TECHNOLOGY, DC-46 GHz

The KAPTON insulator design is excellent for high frequency measurements in test laboratories. KAPTON is also very stable with temperature. Radiall SMA 2.9 adapters using KAPTON are specified DC-46 GHz and operate within a large temperature range - 65°C/+200°C.

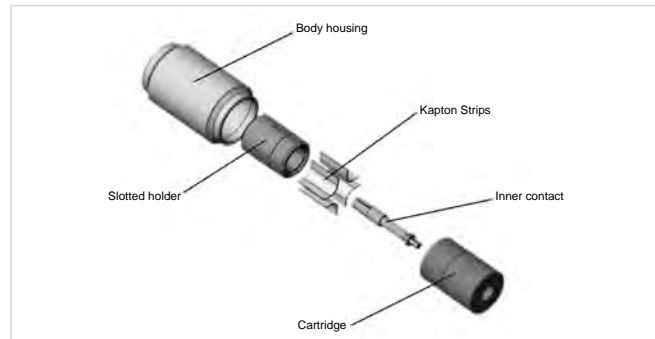

3D view of SMA 2.9 “KAPTON” design

SMA 2.9 FOR SPACE APPLICATIONS

Radiall is a certified manufacturer of connectors for space applications according to ESA specifications. A range of space qualified SMA 2.9 connectors using the ULTEM insulator technology is available. Please consult us.

SMA 2.9 FOR HARSH ENVIRONMENT

Radiall also offers a range of cable assemblies equipped with specific connectors for applications in harsh environment. The connectors are made of high grade stainless steel 316L ultra resistant to corrosion and wear. Please consult us.

Interface

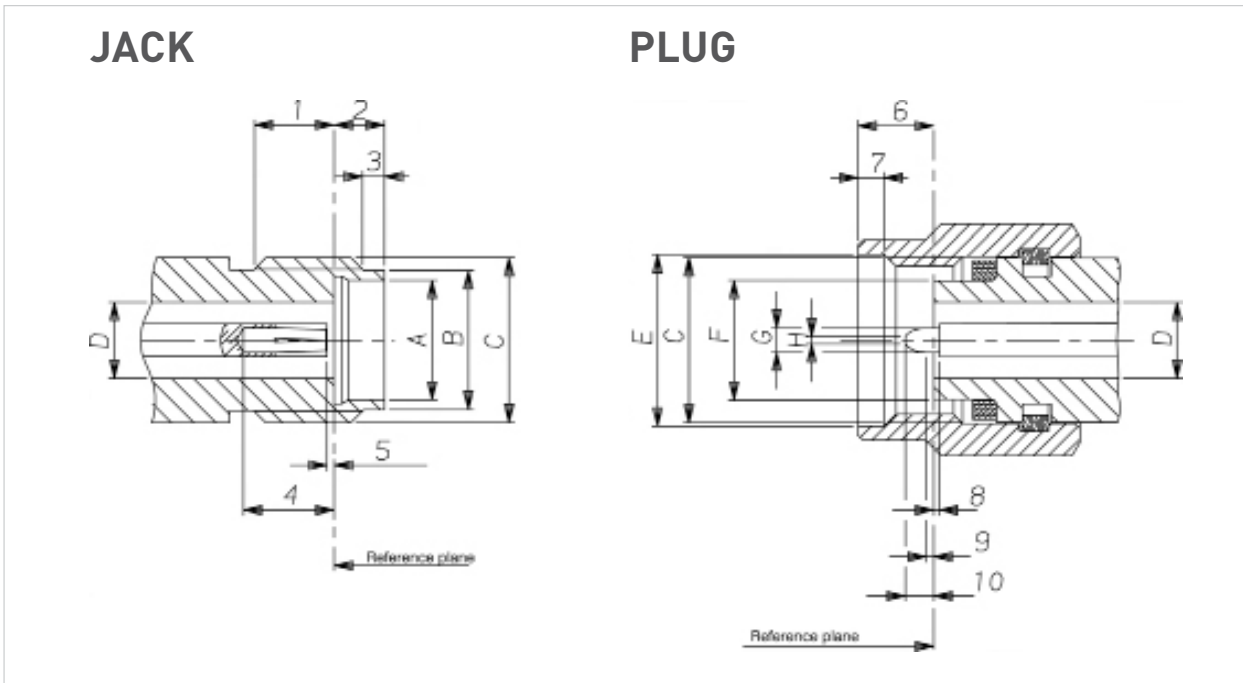

Letter or Figure	mm		inch	
	min.	max.	min.	max.
1	2.87	3.27	.113	.129
2	1.88	1.98	.074	.078
3	0.65	0.95	.026	.037
4	2.40	2.68	.094	.105
5		0.08		.003
A	4.60	4.63	.181	.182
B	5.30	5.35	.209	.211
C	1/4 - 36 UNS 2A			
D	2.90	2.94	.114	.116

Letter or Figure	mm		inch	
	min.	max.	min.	max.
6	2.63	3.25	.103	.128
7	0.90	1.10	.035	.043
8		0.08		.003
9	0.49	0.78	.019	.031
10	1.22	1.40	.048	.055
C	1/4 - 36 UNS 2B			
D	2.90	2.94	.114	.116
E	6.60	6.70	.260	.264
F	4.55	4.58	.179	.180
G	0.92	0.94	.036	.037
H	0.20	0.34	.008	.013

Characteristics

Test / Characteristics	Values / Remarks	
	ULTEM technology	KAPTON technology

ELECTRICAL CHARACTERISTICS

Impedance	50Ω	
Frequency range	DC - 40 GHz	DC - 46 GHz
V.S.W.R.	< 1.05 + 0.005 F (GHz)	
Insertion loss	0.03 √ F (GHz)	
RF leakage	- 90 dB max	
Insulation resistance	≥ 5000 MΩ	
Contact resistance	≤ 2 mΩ	
• Outer conductor	straight ≤ 3 mΩ	
• Inner conductor	hermetic ≤ 7 mΩ	
Voltage rating	350 V(RMS)	
Dielectric withstanding voltage	750 V(RMS)	

MECHANICAL CHARACTERISTICS

Mechanical endurance	500 matings	
Force to engage and disengage	≤ 23 N cm [2 in/lbs]	
Mating torque	80 to 115 N cm [7 to 10 in/lbs]	
Coupling nut retention force	≤ 272 N [61 lbf]	
Cable retention force		
• .085"	135 N [30 lbf]	
• .141"	270 N [60 lbf]	
Contact captivation	28N [6.3 lbf]	

ENVIRONMENTAL CHARACTERISTICS

Temperature range	-65°C / + 165°C	-65°C / +200°C
Thermal shock	MIL STD 202, method 107, condition B	
High temperature test	MIL STD 202, method 108	
Corrosion (salt spray)	MIL STD 202, method 101, condition B, 5 %	
Vibration	MIL STD 202, method 204, condition D, 20g	
Shock	MIL STD 202, method 213, condition I, 100g	
Moisture resistance	MIL STD 202, method 106	

MATERIALS AND PLATING

	Material	Plating
Bodies	Stainless steel	Passivated
Center contacts	Beryllium copper	Gold plated
Gaskets	Silicone rubber	
Insulators	Ultem (Ultem technology) Kapton (Kapton technology)	

Packaging: unit

All dimensions are given in mm (inch).

Plugs

STRAIGHT PLUGS, SOLDER TYPE FOR MICROPOROUS SEMI-RIGID CABLES

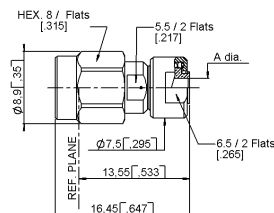

Cable group	Cable group dia.	Part number	Insulator	Dimension A (mm)	Captive center contact	Frequency range
RG405	.085" microporous	R127 800 001	ULTEM	2.25	yes	DC - 40 GHz
RG402	.141" microporous	R127 800 101		3.66		
RG405	.085" microporous	R127 052 001	KAPTON	2.2		DC - 46 GHz
	.116" microporous	R127 055 001		3.0		

Jacks and receptacles

STRAIGHT JACK SOLDER TYPE FOR MICROPOROUS SEMI-RIGID CABLES

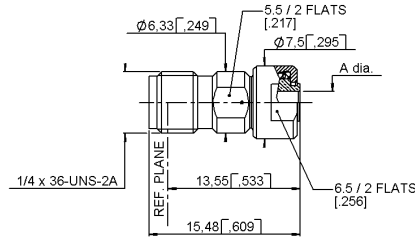

Cable group	Cable group dia.	Part number	Insulator	Dimension A (mm)	Captive center contact	Frequency range
RG405	.085" microporous	R127 820 001	ULTEM	2.25	yes	DC - 40 GHz

UNIVERSAL SCREW-ON FEMALE RECEPTACLES

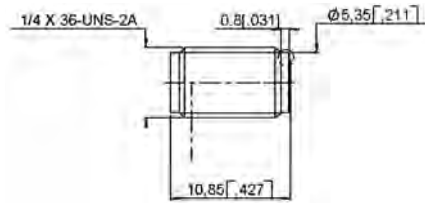

Part number	Insulator	Frequency range	Used with glass bead	For pin diameter
R127 841 001	ULTEM	DC - 40 GHz	R280 760 040	0.3 (.012)
R127 601 001	KAPTON	DC - 46 GHz	R280 760 000 included	
R127 601 421				

FLANGE FEMALE RECEPTACLES

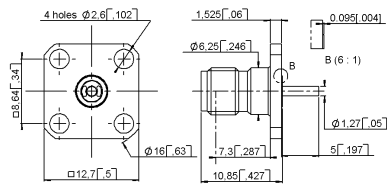

Fig. 1

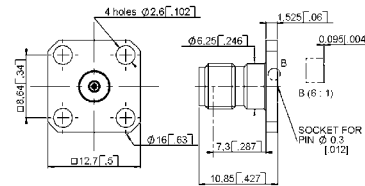

Fig. 2

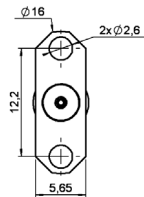

Fig. 3

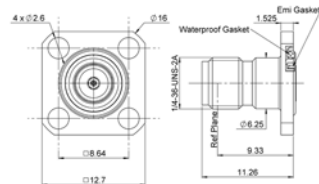
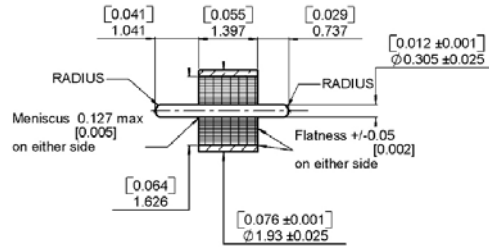
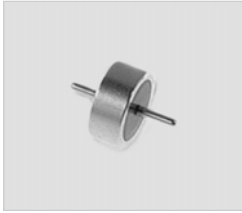

Fig. 4

Part number	Fig.	Insulator	Captive center contact	Panel drilling	Used with glass bead	Note
R127 840 021	1	ULTEM	yes	P02	N/A	With cylindrical center contact
R127 842 001	2			P01	R280 760 040	Accept pin dia 0.3 (.012)
R127 631 001	3	KAPTON				
R127 632 001						
R127 842 101	4	PEEK		P01		Accept pin dia 0.3 (.012) Panel leakage IP67

Glass bead and in series adapters

GLASS BEAD



Part number	Packaging
R280 760 040	100

IN SERIES ADAPTERS

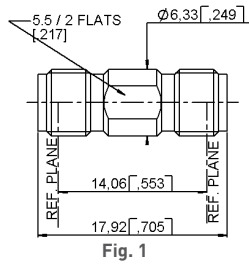

Fig. 1

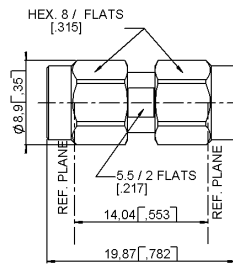

Fig. 2

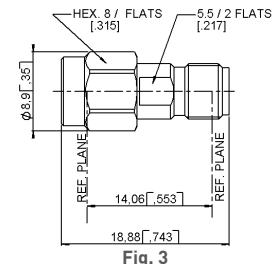

Fig. 3

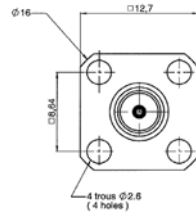

Fig. 4

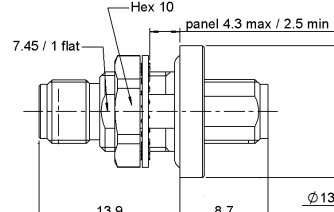

Fig. 5

Part number	Fig.	Insulator	Note	Frequency range
R127 703 001	2	KAPTON	male-male	DC - 46 GHz
R127 704 001	3		female-male	
R127 705 001	1		female-female	
R127 712 001	4		female-female - 4 hole flange	
R127 732 100	5		female-female - bulkhead panel sealed	
R127 753 000	5		female-female - bulkhead hermetic	
R127 870 001	1	ULTEM	female-female	DC - 40 GHz
R127 872 001	3		female-male	
R127 871 001	2		male-male	

Between series adapters

BETWEEN SERIES ADAPTERS

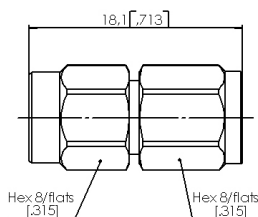

Fig. 1

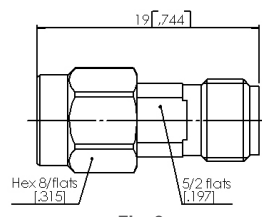

Fig. 2

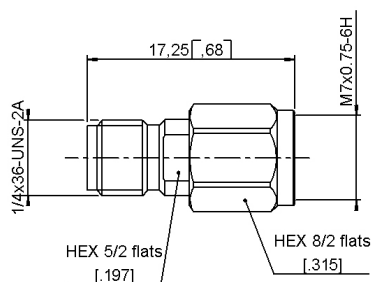

Fig. 3

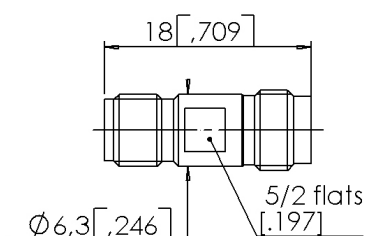

Fig. 4

Part number	Fig.	Insulator	Note	Frequency range
R191 970 061	1	KAPTON	SMA 2.9 male - SMA 2.4 male	DC - 46 GHz
R191 970 071	2		SMA 2.9 male - SMA 2.4 female	
R191 970 081	3		SMA 2.9 female - SMA 2.4 male	
R191 970 091	4		SMA 2.9 female - SMA 2.4 female	

Remark:

These adapters are still using the previous technology (4 kapton strips) allowing to reach 46 GHz within a temperature range of - 65 °C/+ 200 °C.

Panel drilling

P01

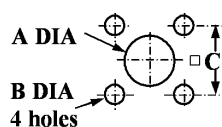

letter	mm		inch	
	maxi	mini	maxi	mini
A	1.63	1.60	.064	.063
B	2.70	2.60	.106	.102
C	8.69	8.59	.342	.338

P02

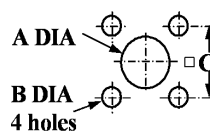

letter	mm		inch	
	maxi	mini	maxi	mini
A	2.95	2.91	.116	.115
B	2.7	2.6	.106	.102
C	8.69	8.59	.342	.338

Introduction

2.4 mm connectors are 50 ohm precision connectors designed for use to 50 GHz. The design eliminates the fragility of the SMA and 2.92 mm connectors by increasing the outer wall thickness and strengthening the female fingers. The outer conductor measures 2.4 mm and the robust wall of the connector body is designed to engage before the center conductor, assuring a rugged, repeatable mating interface. The male connectors are provided with a 8 mm [5/16 in.] hex coupling nut so they can be properly torqued.

2.4 mm connectors are mechanically compatible with 1.85 mm connectors. They cannot mate with SMA, 3.5-mm and 2.92-mm without the use of precision adapters.

Radiall offers 2.4 mm connectors for semi-rigid and low loss flexible cables, receptacles, and precision adapters.

Connectors for low loss flexible cables and TestPro cables are not detailed in this section. They are available in our cable assembly offer.

2.4 mm DESIGN FEATURES

- Excellent performance up to 50 GHz
- Low VSWR and insertion loss
- Rugged construction for reliability
- Mechanically compatible with 1.85 mm connector series

Interface

JACK

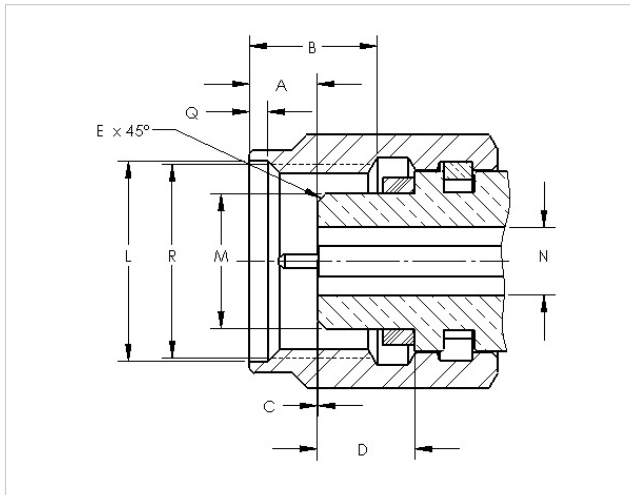

Letter	mm		inch
	min.	max.	min.
A	1.8500	2.4500	0.0728
B	4.3400	4.6600	0.1709
C	0.0000	0.0760	0.0000
D	3.3800	3.4800	0.1331
L	7.0100	7.1100	0.2760
M	4.7250	4.7500	0.1860
N	2.3875	2.4125	0.0940
Q	0.5100	0.7700	0.0201
R	M7x0.75-6H		

PLUG

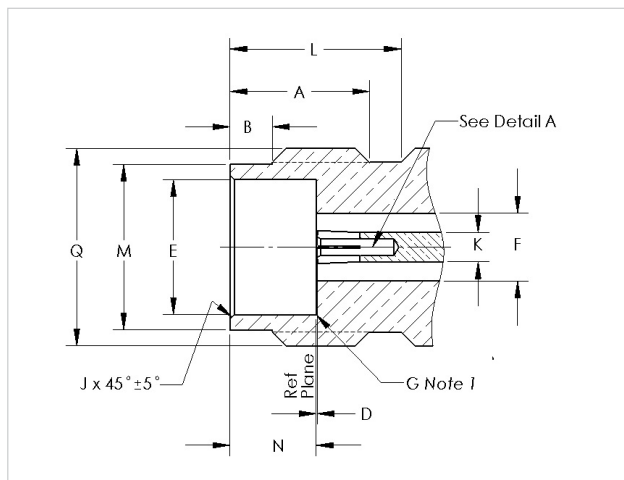

Letter	mm		inch
	min.	max.	min.
A	4.8000	5.0600	0.1890
B	1.3700	1.6300	0.0539
D	0.0000	0.0760	0.0000
E	4.7700	4.7950	0.1878
F	2.3875	2.4125	0.0940
K	1.0290	1.0540	0.0405
L	6.0000		0.2362
M	5.7900	5.8900	0.2280
N	3.0000	3.1000	0.1181
Q	M7x0.75-6g		

Characteristics

Test / Characteristics	Values / Remarks
------------------------	------------------

ELECTRICAL CHARACTERISTICS

Impedance	50Ω
Frequency range	DC - 50 GHz
V.S.W.R.	< 1.05 + 0.003 F (GHz)
Insertion loss	0.04 √ F (GHz)
RF leakage	- 100 dB max
Insulation resistance	<= 1400Veff
- contact resistance	≥ 5000 mΩ
Contact resistance	
• Outer conductor	≤ 0.8 mΩ
• inner conductor	≤ 4 mΩ
Voltage rating	250 V(RMS)
Dielectric withstanding voltage	500 V(RMS)

MECHANICAL CHARACTERISTICS

Mechanical endurance	500 matings
Force to engage and disengage	≤ 23 N cm
Mating torque	90 N cm
Coupling nut retention force	≤ 272 N
Cable retention force	
• Outer conductor	130 N
• inner conductor	
Contact captivation	27N

ENVIRONMENTAL CHARACTERISTICS

Temperature range	-65°C / + 165°C
Thermal shock	MIL STD 202, method 107, condition B, -65°C / + 165°C
High temperature test	MIL STD 202, method 108, condition D, 1000 H at 150°C
Corrosion (salt spray)	MIL STD 202, method 101, condition B, 48 H / 35°C / 5 %
Vibration	MIL STD 202, method 204, condition H, 30g RMS
Shock	MIL STD 202, method 213, condition I, 100g
Moisture resistance	MIL STD 202, method 106, 80% / 100% 25°C / 65°C 10 cycles

MATERIALS AND PLATING

	Material	Plating
Bodies	Beryllium copper	Cu2.5 Au0.8
Outer contact (body insert)	Brass	Cu2.5 Au0.8
Center contacts	Beryllium copper	Ni2 Au1.3
Coupling nut	Stainless steel	Passivated
Gaskets	Silicone rubber	
Insulators	PEEK	

Plugs, jacks and receptacles

STRAIGHT PLUGS, SOLDER TYPE FOR SEMI-RIGID CABLES

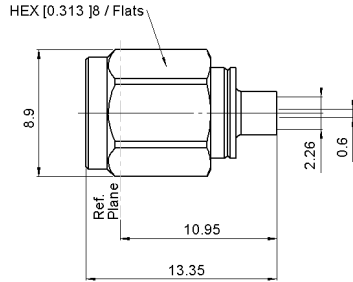

Cable group	Cable group dia.	Part number	Captive center contact
RG405	.085"	R327 052 000	yes
RG405	.085" microporous	R327 052 202	

STRAIGHT JACKS, SOLDER TYPE FOR SEMI-RIGID CABLES

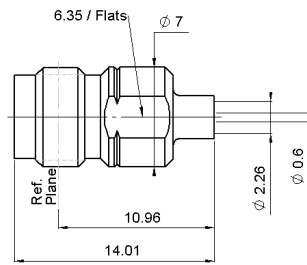

Fig. 1

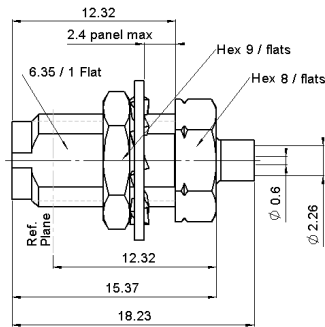
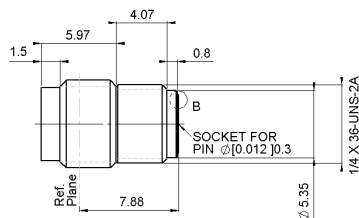

Fig. 2

Cable group	Cable group dia.	Fig.	Part number	Captive center contact
RG405	.085"	1	R327 222 000	yes
	.085" microporous		R327 222 200	
	.085"	2	R327 316 000	
	.085" microporous		R327 316 010	

UNIVERSAL SCREW-ON FEMALE RECEPTACLES



Part number	Using with glass bead	For pin diameter
R327 556 000	R280 760 040	0.3 [0.12]

Receptacles and glass bead

FLANGE RECEPTACLES

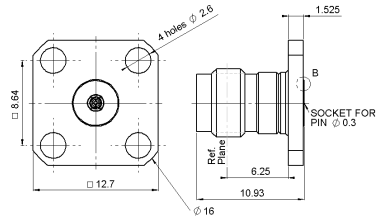

Fig. 1

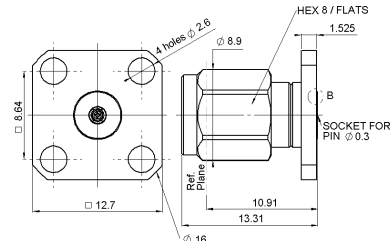

Fig. 2

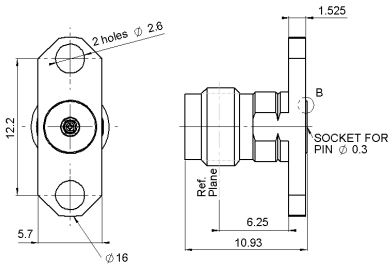
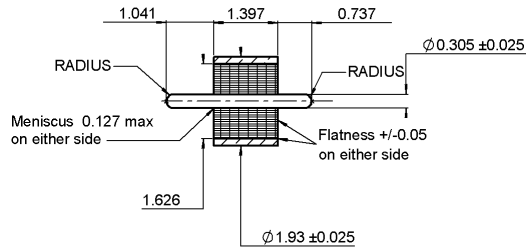

Fig. 3

Part number	Fig.	Captive center contact	Panel drilling	Use with glass bead	For pin diameter
R327 430 000	1	yes	P01	R280 760 040	0.3 (0.12)
R327 411 000	2		P02		
R327 465 000	3				

GLASS BEAD



Part number	Packaging
R280 760 040	100

In Series adapters and panel drilling

IN SERIES ADAPTERS

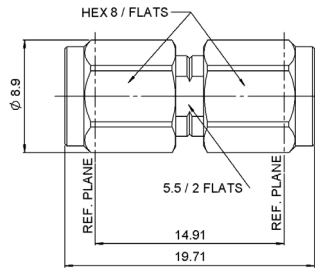

Fig. 1

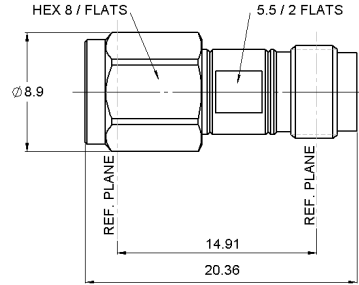

Fig. 2

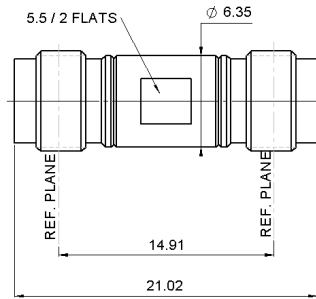

Fig. 3

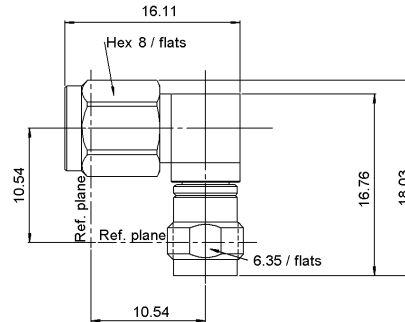
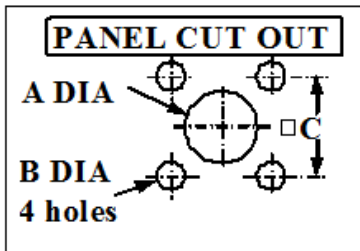

Fig. 4

Part number	Fig.	Note
R327 703 000	1	male/male
R327 704 000	2	male/female
R327 705 000	3	female/female
R327 771 000	4	male/female right angle

Panel drilling

P01



P02

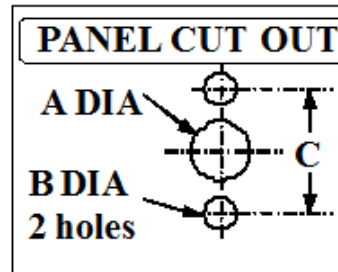

Letter	mm		inch	
	min.	max.	min.	max.
A	1.63	1.60	0.064	0.063
B	2.70	2.60	0.106	0.102
C	8.69	8.59	0.342	0.338

SECTION 11



N / TNC / C

R161 / R162 / R143 / R144 / R166



Contents

TYPE N

Introduction 11-4 to 11-5
 Panel drilling 11-23

N 50Ω and COMPOSITE N

Interface 11-6
 Characteristics 11-8 to 11-9
 Plugs 11-11 to 11-13
 Jacks 11-13 to 11-16
 Receptacles 11-16 to 11-19
 Composite N receptacle 11-18
 Adapters 11-19
 Caps 11-20
 Accessories 11-20

N 75Ω

Interface 11-7
 Characteristics 11-10
 Plugs 11-21
 Jacks 11-21
 Receptacles 11-22
 Adapters 11-22

TNC

Introduction 11-24
 Interface 11-25
 Characteristics 11-26
 Panel drilling 11-34

TNC 50Ω

Plugs 11-27 to 11-28
 Jacks 11-28 to 11-30
 Receptacles 11-30 to 11-31
 Caps 11-31
 Adapters 11-32

TNC 75Ω

Plugs 11-33
 Jacks 11-33

C CONNECTORS

Introduction 11-35
 Interface 11-35
 Characteristics 11-36
 Plugs, jacks and receptacles 11-37 to 11-38
 In series adapters 11-38
 Panel drilling 11-38

Introduction



50Ω	DC - 11 GHz (standard N) DC - 18 GHz (N 18 GHz)
75Ω	DC - 1.5 GHz

GENERAL

- Standard coaxial connectors
- Screw-on coupling
- High durability and proven strength
- High power rating
- Excellent RF performance

APPLICATIONS

- Wireless communications
- Civil and military radio-telecommunication equipment
- Countermeasure
- Navy equipment
- Industrial applications

APPLICABLE STANDARDS

- MIL-C-39012 / MIL STD 348-304
- CEI 169-16
- CECC 22210
- NF-C-93566
- DS 8811

COMPOSITE RECEPTACLES

Radiall introduces its new composite N receptacles. Composite N connectors offer outstanding electrical performance and are the best compromise in terms of weight, cost and mechanical characteristics to replace existing brass technology.

Features and benefits

Intermateable with standard N connectors for backward compatibility

Evenly distributed contact pressure for a better intermodulation

Composite material to remove any potential corrosion in outdoor applications

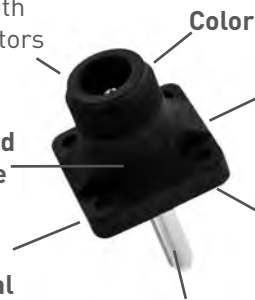

Color coding, optional

Light material for weight saving for cost sensitive equipments

Best material selection for outstanding torque resistance

Many center contact options available for an easy adaptation to customers' application

POWER SWITCHING CONNECTORS

It's a "two in one" solution replacing the existing standard RF switches by integrating the switch function into a receptacle connector. This solution provides a unique means of switching between two RF signal paths. As user friendly as a standard connector, the switch is mechanically activated by mating and unmating the connector.

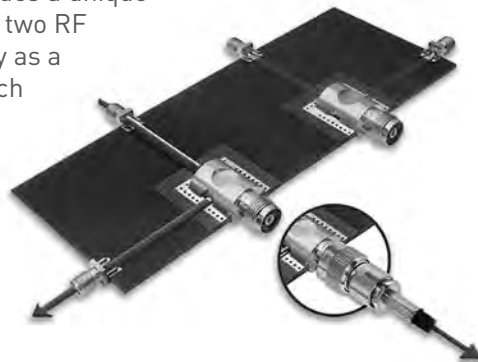

Main advantages

- Reliable
- Increases the density
- Excellent electrical and mechanical performances
- Reduction of the cost of ownership
- Betty RF adaptation
- Good isolation
- Available in right or left versions

Main applications

- Telecom applications
- RF power amplifiers

Introduction

Radiall offers a wide range with a standard plating finish:
BBR (Bright Bronze Radiall) = high performance non magnetic alloy

• FULL CRIMP MODELS

A fast and reliable attachment system that can be easily achieved in a field environment, with minimum easy-to-use tooling (including models for 2 and 2.6 mm dia cables). All our full crimp connectors are single piece body.

• LOW INTERMODULATION CONNECTORS

Radiall maintains extensive knowledge in this field and has developed N series connectors that are specially designed for base stations of applications where the elimination of intermodulation products is of the utmost importance:

- Optimized for 900 - 1800 MHz bands (and able to work up to 11 GHz like the standard models)
- IMP_3 performance = -110 dBm (-153 dBc)
- New models for corrugated and low loss flexible cables
- High performance non magnetic materials and platings (silver and BBR)
- New 6 flats coupling nut (18 mm), allowing high coupling torque (170 Ncm) thanks to torque wrench
- Non slotted outer contact

• 18 GHz PRECISION CONNECTORS

Suitable for medium to high power applications and precision microwave test equipment. Long life duration and enhanced electrical performance in severe environmental conditions. N18 series mate with all 50 ohms N connectors.

• VERY LOW INTERMODULATION CABLE ASSEMBLIES

For severe intermodulation conditions, we propose a range of low intermodulation cable assemblies $IMP_3 \leq 125$ dBm

For further details, please read our:

- Intermodulation application guide **(D1 032 DE)**
- BBR plating application guide **(D1 030 DE)**

IMPORTANT: the 50Ω and the 75Ω connectors are NOT INTERMATEABLE, results in the interface destruction.



Interface N 50 Ω

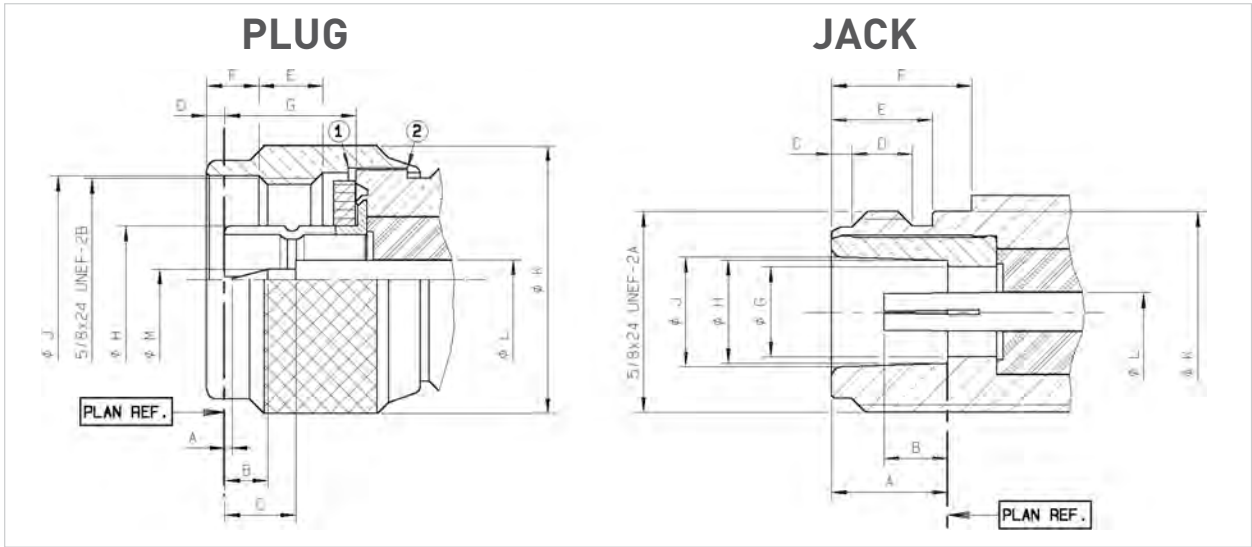

LETTER	mm		inch	
	min.	max.	min.	max.
A	0.13	1.03	.005	.13
B	2.80	3.56	.110	.140
C	5.33	5.83	.210	.229
D	1	2	.016	.066
E	4.54	5.39	.179	.212
F	4.05	4.20	.159	.165
G	10.23	10.43	.403	.411
H DIA	8.27	8.37	.326	.329
J DIA	16.1	16.2	.634	.638
K DIA	20.9	21	.823	.827
L DIA	3.01	3.05	.118	.120
M DIA	1.63	1.67	.064	.066

LETTER	mm		inch	
	min.	max.	min.	max.
A	9.05	9.19	.356	.362
B	4.75	5.25	.187	.207
C	1.20	1.95	.047	.077
D	4.4	5.1	.173	.201
E	6.8	9	.268	.354
F	10.9	11.2	.429	.441
G DIA	6.98	7.02	.275	.276
H DIA	8.03	8.13	.316	.320
J DIA	8.53	8.73	.336	.344
K DIA	15.65	15.85	.616	.624
L DIA	3.01	3.05	.118	.120

Interface N75 Ω

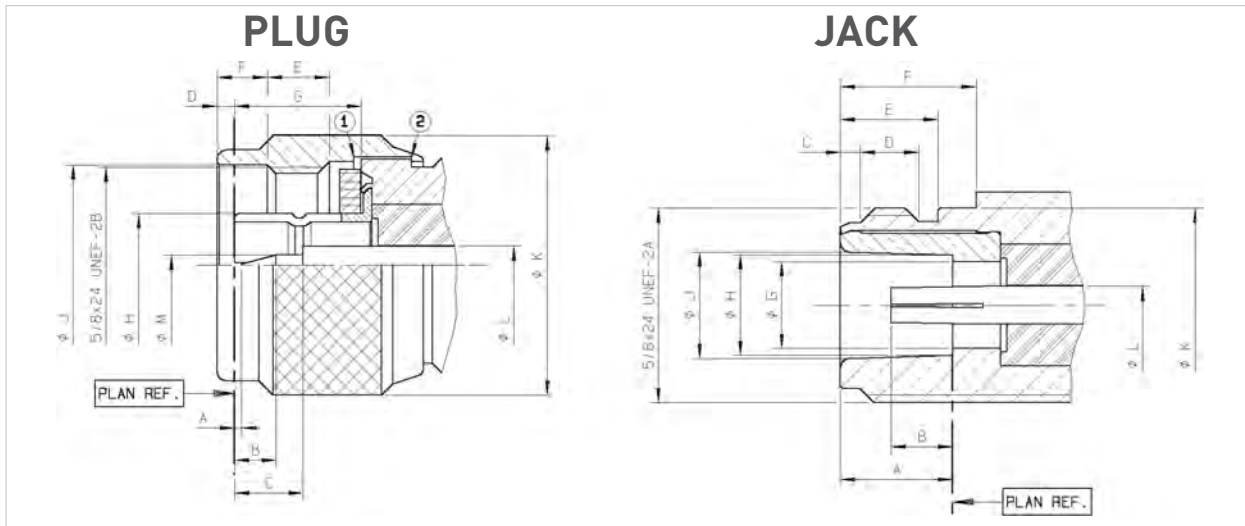

LETTER	mm		inch	
	min.	max.	min.	max.
A	0.13	1.03	.005	.13
B	2.80	3.56	.110	.140
C	5.33	5.83	.210	.230
D	1	2	.016	.066
E	4.54	5.39	.179	.212
F	4.05	4.20	.159	.165
G	10.23	10.43	.403	.411
H DIA	8.27	8.37	.326	.329
J DIA	16.1	16.2	.634	.638
K DIA	20.9	21	.823	.827
L DIA	1.96	2	.077	.079
M DIA	0.87	0.91	.034	.036

LETTER	mm		inch	
	min.	max.	min.	max.
A	9.05	9.19	.356	.362
B	4.75	5.25	.187	.207
C	1.20	1.95	.047	.077
D	4.4	5.1	.173	.201
E	6.8	9	.268	.354
F	10.9	11.2	.429	.441
G DIA	6.98	7.02	.275	.276
H DIA	8.03	8.13	.316	.320
J DIA	8.53	8.73	.336	.344
K DIA	15.65	15.85	.616	.624
L DIA	1.96	2	.077	.079

*statistics dimensions: .0539 .0055 (.0594 max)/(1.37 0.14)(1.51 max)

- 1) Coupling nut against on datum 1
- 2) Coupling nut against on datum 2

IMPORTANT: the 50Ω and the 75Ω connectors are NOT INTERMATEABLE, results in the interface destruction.

Characteristics

Test / Characteristics	Standard reference	Values / Remarks
------------------------	--------------------	------------------

ELECTRICAL CHARACTERISTICS

Impedance		50Ω			
Frequency range		DC - 11 GHz			
Typical V.S.W.R. • Straight models cable group: .085" .141" .250" 5/S+5/D 10/S+11/D • Right angle models: 5/S+D 10/S+11/D		1 GHz	2.5 GHz	5 GHz	11 GHz
		1.03	1.03	1.05	1.08
		1.03	1.05	1.05	1.08
		1.03	1.03	1.05	1.07
		1.05	1.06	1.1	1.16
		1.04	1.05	1.09	1.2
		1.04	1.1	1.18	
		1.04		1.20	
Intermodulation product (IMP ₃) • Standard connectors • Intermodulation connectors • Home made intermodulation cable assemblies		- 90 dBm typ. [- 133 dBc typ. / 20W] - 110 dBm typ. [- 153 dBc typ / 20W] - 125 dBm typ. [- 165 dBc typ. / 20W]			
Insertion loss • Straight connector • Right-angle connector	MIL	< 0.15 dB max at 10 GHz ~ < 0.05 √F (GHz) < 0.15 dB max at 10 GHz ~ < 0.1 √F (GHz)			
RF Leakage	MIL	-90 dB min from 2 to 3 GHz (interface)			
Insulation resistance	MIL	5000 MΩ min			
Contact resistance • Center contact • Outer contact	MIL	Initial 1 mΩ 0.2 mΩ	After tests 1.5 mΩ -		
Working voltage in VRMS • At sea level (at 70, 000 feet)	CECC	Cable 5/50: Cable .085"/.141": Cable 10+11/50: Cable LMR 400/600: Cable .250":	850 350 1400 1400 1400	(250) (250) (400) (400) (400)	
Dielectric withstanding voltage in VRMS • At sea level (at 70, 000 feet)	CECC	Cable 5/50: Cable .085"/.141": Cable 10/50: Cable LMR 400/600: Cable .250":	1500 1000 2500 2500 2500	(350) (350) (600) (600) (600)	
RF testing voltage Sea level	CECC	1500 VRMS (5 MHz sine wave)			

MECHANICAL CHARACTERISTICS

Durability	CECC	500 matings			
Engagement and separation torque	CECC	6.6 Ncm max (.58 Inch-pounds)			
Recommended coupling nut torque		40 to 60 Ncm (manual) 130 Ncm (11.45 inch pounds) (with pliers R 282 202 000) 170 Ncm (14.96 inch pounds) (with torque wrench R 282 303 020)			
Proof torque	CECC	170 Ncm (14.96 inch pounds)			
Coupling nut retention force	CECC	450 N (101.25 Lbs)			
Cable retention force	CECC	Cable 5/50/S Cable 5/50/D Cable 10/50 Cable 11/50 Cable .141"	150N 200N 300N 400N 270N	(33.75 Lbs) (48 Lbs) (67.5 Lbs) (90 Lbs) (60.75 Lbs)	
Center contact retention force Axial	MIL	27 N (6.08 Lbs) cables < ∅ 8 mm 68 N (15.30 Lbs) cables > ∅ 8 mm			

Standard packaging = 50 pieces

Characteristics

Test / Characteristics	Standard reference	Values / Remarks
------------------------	--------------------	------------------

ENVIRONMENTAL CHARACTERISTICS

Temperature range • Standard models • Semi-rigid cables	CECC	- 55°C + 155°C - 55°C + 105°C
Thermo cycling test	CECC	- 55°C/+ 155°C/21 j
Thermal shock	CECC	- 40°C/+ 155°C or - 40°C/+ 85°C - 5 cycles
High temperature test	CECC	125°C/1000 H
Corrosion salt spray	CECC	48 H
Vibration	CECC	Sinus 10g/10 – 500 Hz
Shock	CECC	1/2 Sinus 50g/11 ms
Moisture resistance • Clamp type • Crimp type	IEC 529	IP 67 IP 65 (with heatshrink sleeve)
Hermetic test	CECC	10 ⁻⁵ bar. cm ³ /s
Leakage	CECC	Differential pressure 100 to 110 KPa: 1 bar cm ³ / H

MATERIALS

Body / nut / center male contact / outer contact	Brass
Center female contact	Treated beryllium copper
Ferrule	Brass
Insulator	PTFE
Gasket	Silicon elastomer

PLATING

	Standard	Intermodulation models + COAXI-KIT
Body • Crimp + clamp type • Solder type	BBR Gold	Silver + BBR Silver
Coupling nut/Design	BBR/cross knurled	BBR/hex.
Center contacts	Gold	Silver
Outer contacts/Design	BBR/slotted	Silver + BBR/non slotted

PACKAGING

Packaging	50 pieces bulk Unit packaging
-----------	----------------------------------

Some connectors may feature different performances depending on the application they have been designed for, or according to the applicable cable.

Characteristics

Test / Characteristics	Standard reference	Values / Remarks
------------------------	--------------------	------------------

ELECTRICAL CHARACTERISTICS

Impedance		75Ω
Frequency range		DC - 1.5 GHz
Typical V.S.W.R. • Cable 6/75 • Cable 10+11/75		1.06 1.10
Insertion loss • Straight connector • Right-angle connector	MIL	< 0.15 dB
RF Leakage	MIL	- 90 dB min at 1 GHz
Insulation resistance	MIL	5000 MΩ min
Contact resistance • Center contact • Outer contact	MIL	Initial 1 mΩ 0.2 mΩ After tests 1.5 mΩ -
Working voltage in VRMS at sea level (at 70 000 feet)	CECC	Cable 10+11/75: 1400 (400) Cable 6/75: 850 (250)
Dielectric withstanding voltage in VRMS At sea level (At 70 000 feet)	CECC	Cable 10+11/75: 2500 (600) Cable 6/75: 1500 (350)
RF testing voltage Sea level	CECC	1500 VRMS (5 MHz sine wave)

MECHANICAL CHARACTERISTICS

Durability	CECC	500 matings
Engagement and separation torque	CECC	6.6 Ncm max (.58 Inch-pounds)
Recommended coupling nut torque	CECC	40 to 60 Ncm (manual) 130 Ncm (11.45 inch pounds) (with pliers R282 202 000)
Proof torque	CECC	170 Ncm (14.96 inch pounds)
Coupling nut retention force	CECC	450 N (101.25 Lbs)
Cable retention force • Cable 6/75 • Cable 10+11/75	CECC	200 N 300 N
Center contact retention force Axial	MIL	27 N (6.08 Lbs)

ENVIRONMENTAL CHARACTERISTICS

Temperature range	CECC	- 55°C + 155°C
Thermo cycling test	CECC	- 55°C / + 155°C / 21 j
Thermal shock	CECC	- 40°C / + 155°C or - 40°C / + 85°C - 5 cycles
Hight temperature test	CECC	125°C / 1000 H
Corrosion salt spray	CECC	48 H
Vibration	CECC	Sinus 10 g / 10 - 500 Hz
Shock	CECC	1/2 Sinus 50g / 11 ms
Moisture resistance • Clamp type • Crimp type	IEC 529	IP 67 IP 65 (with heatshrink sleeve)
Hermetic test	CECC	10-5 bar. cm ³ /s
Leakage	CECC	Differential pressure 100 to 110 KPa: 1 bar cm ³ / H

MATERIALS

Body (nut)/center male contact/outer contact)	Brass
Center female contact	Treated beryllium copper
Ferrule	Brass
Insulator	PTFE
Gasket	Silicon elastomer

PLATING

Body	BBR
Coupling nut/design	BBR / cross knurled
Center contact	Gold
Outer contact/design	BBR / slotted

Standard packaging = 50 pieces

Plugs

STRAIGHT PLUGS, FULL CLAMP AND CRIMP TYPE, FOR FLEXIBLE CABLES (single piece body)

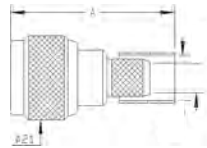

Fig. 1

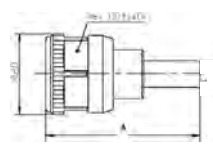

Fig. 2

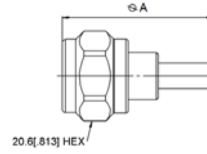

Fig. 3

Cable group	Cable group dia.	Part number	Fig.	Dimensions (mm)		Captive center contact	Note
				A			
RG174 / RG316 / RD316 / AEP-100FR	2.6/50/S+D & LMR® 100	R161 072 000	1	39.7	yes	For intermodulation application tool	
RG58 / R141	5/50/S	R161 082 000 R161 083 000		38.5			
RG142 / RG223 / RG400	5/50/D	R161 083 137	2	38.5			
RG213	10/50/S	R161 075 000 R161A 075 000	1	40.2	no		
	10.3/50/S	R161 075 060 R161 088 000		37.2	yes	LMR 400 cable	
RG214	11/50/D	R161 088 137	2	40.2		For intermodulation application tool	
AEP-195FR	LMR® 195	R161 082 120	3	38.5	yes	Crimp type	
AEP-200FR	LMR® 200	R161 082 200	1	38.5			
AEP-240FR	LMR® 240	R161 075 030	3	38.5			
AEP-400FR	LMR® 400	R161 088 180		40.1			
RD316	2.6/50D	4000-7071-019	1	40.41	no	Crimp type for flexible cable	

STRAIGHT PLUGS, CLAMP TYPE, FOR FLEXIBLE CABLES

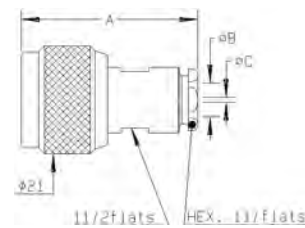

Fig. 1

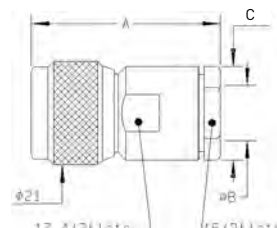

Fig. 2

Cable group	Cable group dia.	Part number	Fig.	Dimensions (mm)			Captive center contact
				A	B dia.	C dia.	
RG174 / RG316 / RD316	2.6/50/S+D	R161 004 000	1	33.9	3.1	1.7	yes
RG58 / RG141 / RG142 / RG223 / RG400	5/50/S+D	R161 006 000 R161 010 000		34.4	5.6		no
RG59 / RG62 / RG71	6/75+93	R161 012 000		34.9	5.6		yes
RG213 / RG393 / RG11 / RG12 / RG144 / RG214 / RG216	10+11/50+75	R161 018 000	2	34.4	6.6		
		R161 020 000		44	11.2	17.5	
		R161 022 000		38.1	11.2	17.5	no
RG217	14/50/D	R161 027 000		38.9	11.2	19	yes
				40.9	14.4	22.2	

Plugs

STRAIGHT PLUGS, FOR SEMI-RIGID CABLES

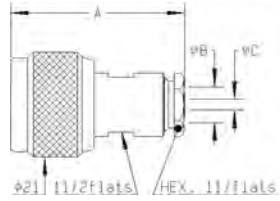

Fig. 1

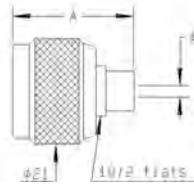

Fig. 2

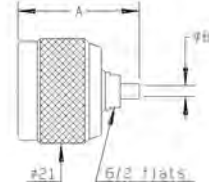

Fig. 3

Cable group	Cable group dia.	Part number	Fig.	Dimensions (mm)			Captive center contact	Note
				A	B dia.	C dia.		
RG405	.085"	R161 050 300	3	24.4	2.25		no	Solder type
RG402	.141"	R161 051 000			3.65			
RG401	.250"	R161 052 000	1	35	5.6	3.65	no	Clamp type
		R161 053 000	2	35.4	6.6			Solder type
		R161 054 000	2	24.4	6.45			Solder type

RIGHT ANGLE PLUGS, CRIMP TYPE, FOR FLEXIBLE CABLES

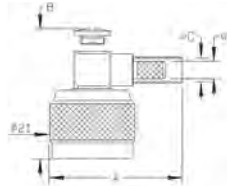

Fig. 1

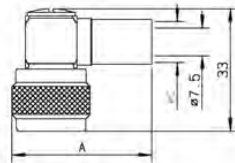

Fig. 2

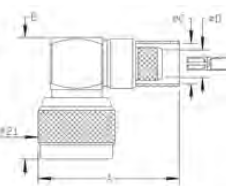

Fig. 3

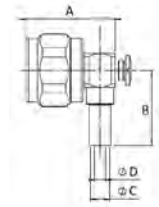

Fig. 4

Cable group	Cable group dia.	Part number	Fig.	Dimensions (mm)				Captive center contact	Note
				A	B	C dia.	D dia.		
RG174 / RG316	2.6/50/S	R161 181 000	1	29.5	26.3			no	
RG58 / RG141	5/50/S	R161 182 000		34.5	28	5.41			
RG142 / RG223 / RG400	5/50/D	R161 183 000	1	34.5	28	5.8	3.1	no	ECO version
		R161A 183 000							Full crimp
		R161 185 000	3	42.4	33.2	11.05	7.46	yes	Full crimp
		R161 186 000	2	37.6		11.4			Full crimp
RG214	11/50/D	R161 187 000	3	42.4	33.2	11.4	7.46	yes	Full crimp
		R161 188 000	4	31.7	39.1	15.88	11.96		Crimp type
AEP-200FR	LMR® 200	R161 182 080	4	26.3	22	5.55	3.25	yes	Crimp type
AEP-240FR	LMR® 240	R161 183 310		26.3	24	6.6	4.05		
AEP-400FR	LMR® 400	R161 184 080		27	33	11.05	7.46		
AEP-600FR	LMR® 600	R161 188 200		31.7	39.1	15.88	11.96		

RIGHT ANGLE PLUGS, CLAMP TYPE, FOR FLEXIBLE CABLES

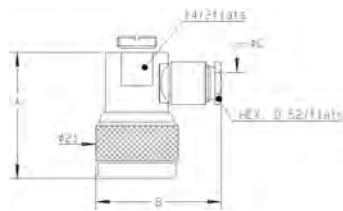

Fig. 1

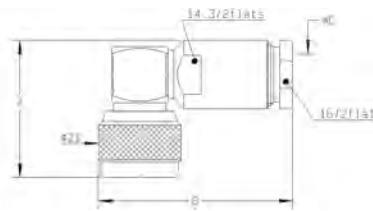
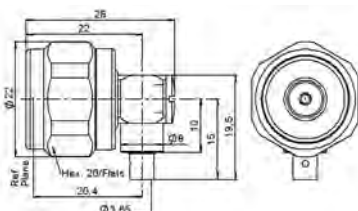

Fig. 2

Cable group	Cable group dia.	Part number	Fig.	Dimensions (mm)			Captive center contact
				A	B	C dia.	
RG223 / RG142 / RG223 / RG400	5/50/S+D	R161 157 000	1	32	32	5.6	yes
RG213 / RG393 / RG214	10+11/50/S+D	R161 168 000	2	34.85	49.4	11.2	yes

Plugs and jacks

RIGHT ANGLE PLUG, SOLDER TYPE, FOR SEMI-RIGID CABLES



Cable group	Cable group dia.	Part number	Captive center contact
RG402	.141"	R161 152 107	yes

STRAIGHT JACKS, FULL CRIMP TYPE, FOR FLEXIBLE CABLES (single piece body)

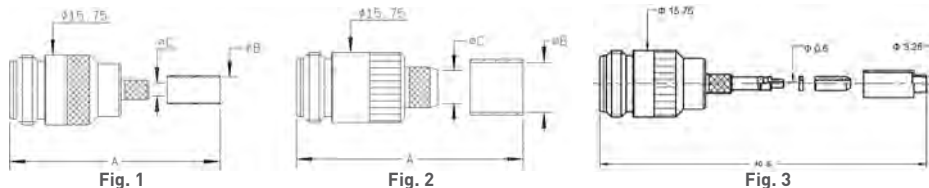

Cable group	Cable group dia.	Part number	Fig.	Dimensions (mm)			Captive center contact
				A	B dia.	C dia.	
RG58 / RG216 / RD316	2.6/50/S+D	R161 236 000	3				yes
RG58 / RG141	5/50/S	R161 237 000	1	39.3	5.41	3.11	
RG142 / RG223 / RG400	5/50/D	R161 238 000			5.8		
RG223	10/50/S	R161 241 000	2	40.6	11.05	7.46	
RG214	11/50/D	R161 243 000			11.4		

STRAIGHT JACKS, CLAMP TYPE, FOR FLEXIBLE CABLES

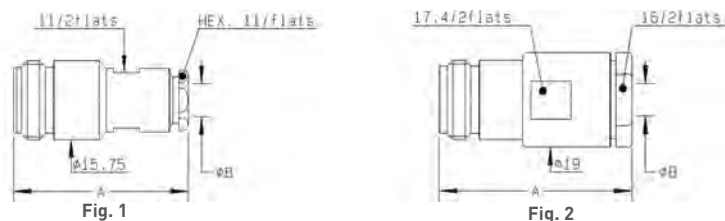

Cable group	Cable group dia.	Part number	Fig.	Dimensions (mm)		Captive center contact
				A	B dia.	
RG58 / RG142 / RG223 / RG400	5/50/S+D	R161 206 000	1	35.3	5.6	yes
RG213 / RG393 / RG214	10+11/50/S+D	R161 220 000	2	39.3	11.2	

STRAIGHT JACKS

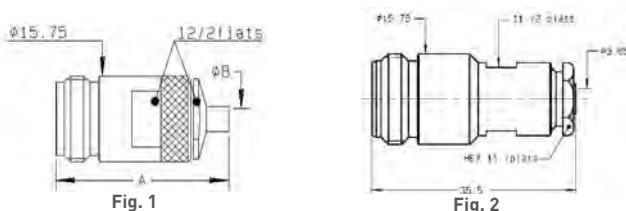

Cable group	Cable group dia.	Part number	Fig.	Dimensions (mm)		Captive center contact	Note
				A	B dia.		
RG402	.141"	R161 226 020	1	32	3.65	no	Solder type
		R161 227 000	2				Clamp type

Jacks

SQUARE FLANGE, STRAIGHT JACKS, FULL CRIMP TYPE, FOR FLEXIBLE CABLES (single piece body)

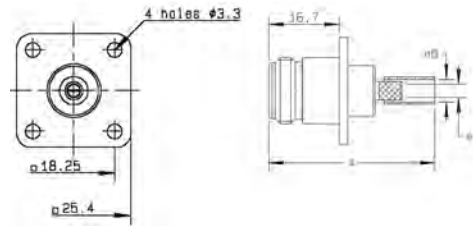

Cable group	Cable group dia.	Part number	Dimensions (mm)			Captive center contact	Panel drilling
			A	B dia.	C dia.		
RG178	2/50/S+D	R161 281 000	40.3	2.35	1		P01
RG174 / RG316 / RD176	2.6/50/S+D	R161 281 300	40.3	3.25	1.63		
RG58 / RG141	5/50/S	R161 282 000	39.3	5.41			
RG142 / RG223 / RG400 / RG213	5/50/D	R161 283 000	39.3	5.8	3.11	yes	
RG213	10/50/S	R161 286 000	40.6	11.05	7.46		

SQUARE FLANGE, STRAIGHT JACKS

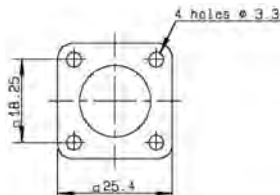

Fig. 1 and 2

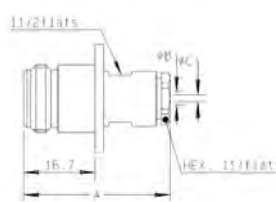

Fig. 1

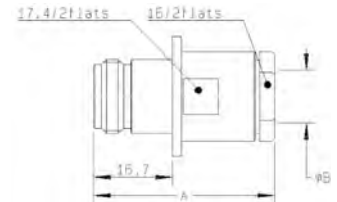

Fig. 2

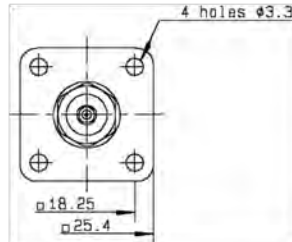
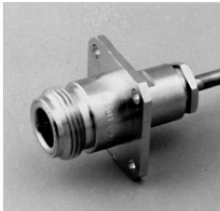

Fig. 3 and 4

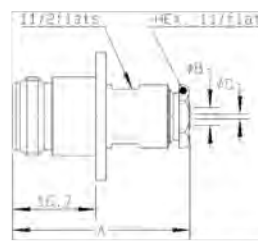

Fig. 3

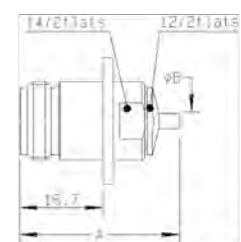

Fig. 4

Cable group	Cable group dia.	Part number	Fig.	Dimensions (mm)			Captive center contact	Panel drilling	Note
				A	B dia.	C dia.			
RG174/RG316/RD316	2.6/50/S + D	R161 252 000	1	34.3	3.1	1.7	yes	P01	Clamp type
RG58/RG141/RG142/RG223/RG400	5/50/S + D	R161 256 000		35.4	5.6				
RG213/RG393/RG214	10 + 11/50/S + D	R161 270 000	2	39.3	11.2		no	P01	Solder type Clamp type
RG402	.141"	R161 277 000	3	35.5	5.6	3.65			
RG401	.250"	R161 278 000	3	35.9	6.6				

Bulkhead jacks

BULKHEAD STRAIGHT JACKS, FULL CRIMP TYPE, FOR FLEXIBLE CABLES (panel sealed) (single piece body)

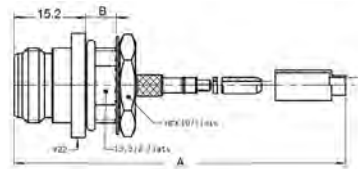

Fig. 1

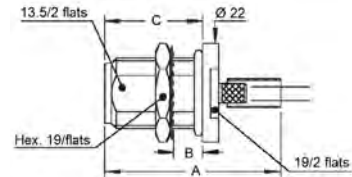

Fig. 2

Cable group	Cable group dia.	Part number	Fig.	Dimensions (mm)			Captive center contact	Panel drilling	Note
				A	B	C			
RG174/RG316/RD316	2.6/50/S+D	R161 311 200	1	40.4	6.5	-	yes	P11	Front mount
		R161 311 300	2	39.8		22.2			Rear mount
RG58 / RG141	5/50/S	R161 329 000							
RG142 / RG223 / RG400	5/50/D	R161 329 200							
RG214	11/50D	R161 331 200		40.6		22			
AEP-200FR	LMR® 200	R161 329 130		39.8		22.2			
AEP-240FR	LMR® 240	R161 329 140		37.8					
AEP-400FR	LMR® 400	R161 331 060		40.6		22			
AEP-600FR	LMR® 600	R161 331 400		49.9	23.7				

BULKHEAD STRAIGHT JACKS, CLAMP TYPE, FOR FLEXIBLE CABLES (panel sealed)

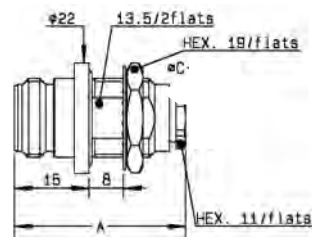

Fig. 1

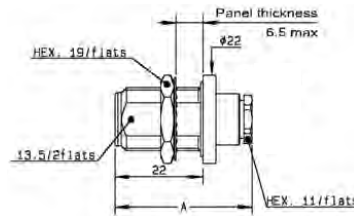

Fig. 2

Cable group	Cable group dia.	Part number	Fig.	Dimensions (mm)	Captive center contact	Panel drilling	Note
				A			
RG174 / RG316 / RD316	2.6/50/S+D	R161 321 000	1	34.3	yes	P11	Front mount
		R161 322 000	2	35.4			Rear mount
RG58 / RG141 / RG142 / RG223 / RG400	5/50/S+D	R161 325 000			43	no	
RG213 / RG393 / RG214	10+11/50/S+D	R161 332 000		30.5			
RG174 / RG316	2.6/50S	4501-7051-003					
RG174 / RG316	2.6/50S	4502-7051-003	1	26.7			

Bulkhead jacks and receptacles

BULKHEAD STRAIGHT JACKS, FOR SEMI-RIGID CABLES (panel sealed)

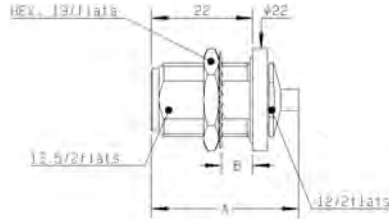

Fig. 1

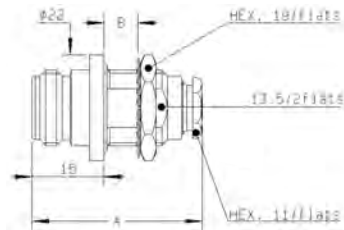

Fig. 2

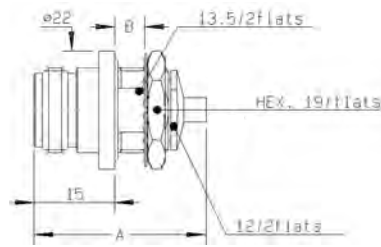

Fig. 3

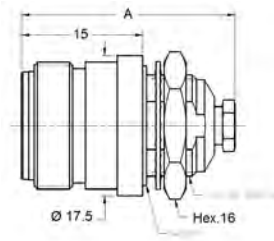
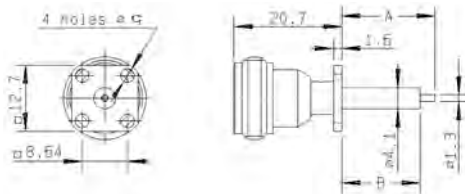

Fig. 4

Cable group	Cable group dia.	Part number	Fig.	Dimensions (mm)		Captive center contact	Panel drilling	Note				
				A	B							
RG405	.085"	R161 335 200	1	32	6.5	no	P11	Solder type / Rear mount				
		R161 323 000	2	35.5	8			Clamp type / Front mount				
RG402	.141"	R161 336 000	1	32	6.5			no	P11	Solder type / Rear mount		
		R161 336 200	3							Solder type / Front mount		
RG401	.250"	R161 337 200	1	26.56				Solder type / Front mount				
RG405	.085"	4502-7041-010	4					Solder clamp / Front mount				
RG402	.141"	4502-7041-009	4					33.52	yes			Solder clamp / Front mount
		4501-9543-009	1									Solder clamp / Rear mount

LOW PROFILE SQUARE FLANGE, STRAIGHT FEMALE RECEPTACLE



Part number	Dimensions (mm)			Captive center contact	Panel drilling	Note
	A	B	C dia			
R161 410 520	17.9	15	2.9	yes	P08	Extended dielectric

Receptacles

FLANGE, STRAIGHT FEMALE RECEPTACLES

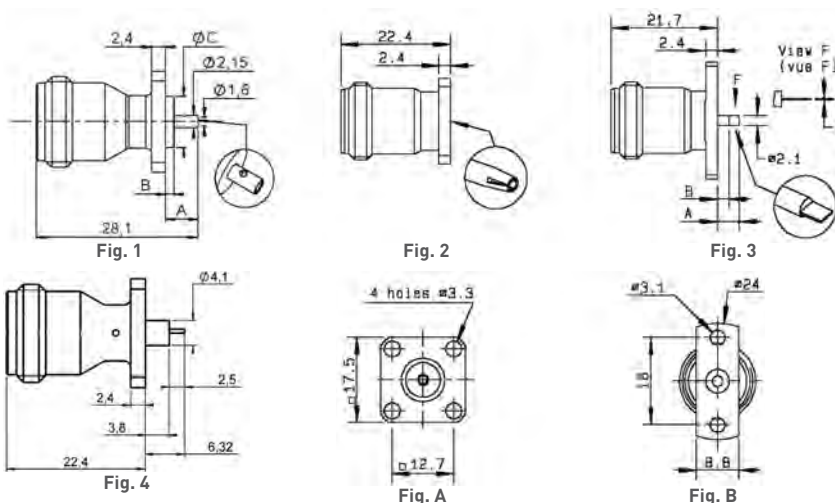

Part number	Fig.	Dimensions (mm)			Captive center contact	Panel drilling	Note
		A	B	C			
R161 410 000	1 + A	5.7	1.5	8.9	yes	P03	ECO version
R161A 410 000							
R161 410 130	4 + A					P13	Solder pot contact
R161 418 000	2 + A					P03	Universal/see contacts page 12-22
R161 461 000	3 + B	6.2	3.9	0.6		P09	2 hole flange/flat tab contact

STRAIGHT MALE AND FEMALE RECEPTACLES

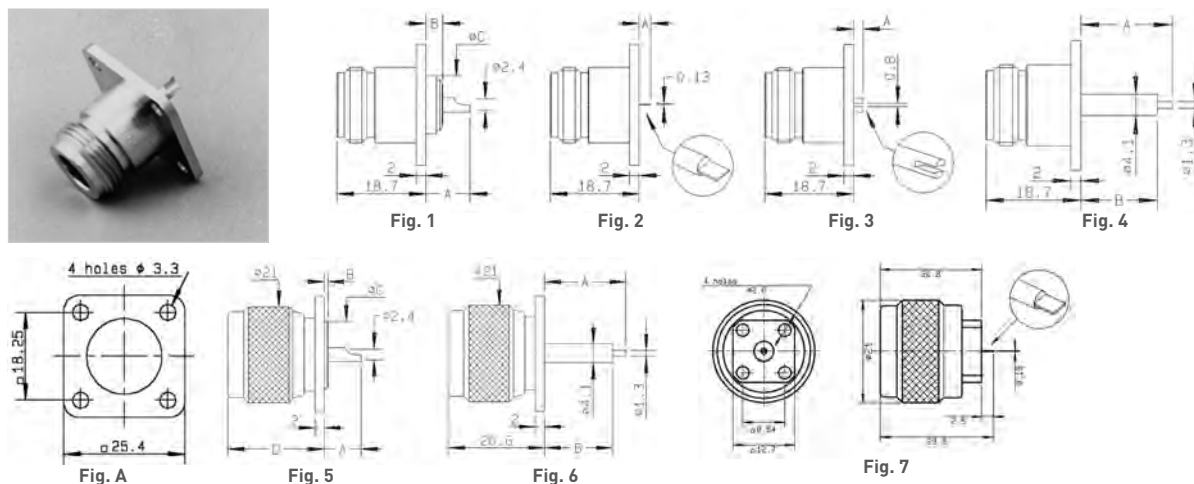

Part number	Fig.	Dimensions (mm)				Captive center contact	Panel drilling	Note
		A	B	C dia	D			
R161 404 000	1 + A	9.3	0.8	14.6		yes	P05	Solder pot
R161A 404 000								Solder pot/ECO version
R161 404 137								For intermodulation application/ Center contact brass
R161 416 130	4 + A	17.9	15		P06		Extended dielectric	
R161 419 020	2 + A	2.5			P07		Flat tab contact	
R161 419 300	3 + A	2			P01	Slotted contact		
R161 441 000	5 + A	8.7	0.8	14.6	20.6	P02	Male/solder pot	
R161 441 400	6 + A	17.9	15			P04	Male/extended dielectric	
R161 438 200	7					P08		

Receptacles

COMPOSITE FEMALE RECEPTACLES

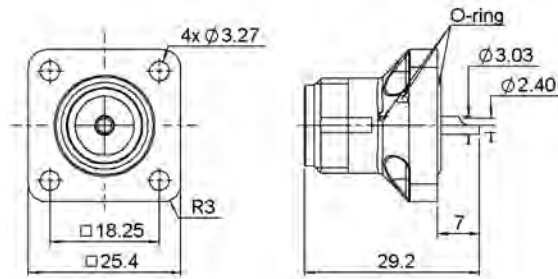

Part number	Captive center contact	Description	Color	Packaging
R161 404 C01	yes	-	Black	50 pieces
R161 404 C02		Combination seal		
R161 404 C03		Panel seal		

Available upon request.
Processed according to customer needs.

RIGHT ANGLE FEMALE RECEPTACLES

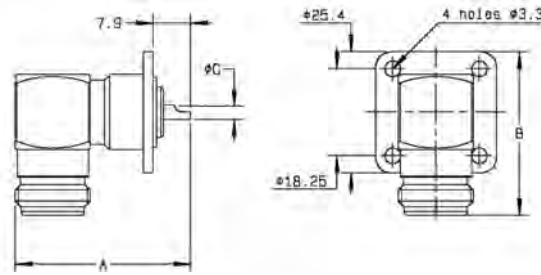

Part number	Dimensions (mm)			Captive center contact	Panel drilling	Note
	A	B	C dia			
R161 653 000	36.9	34.4	2.5	yes	P02	Solder pot

BULKHEAD STRAIGHT RECEPTACLES (fully sealed or panel hermetic)

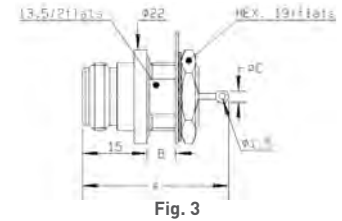
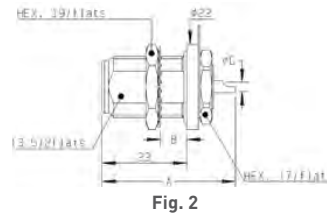
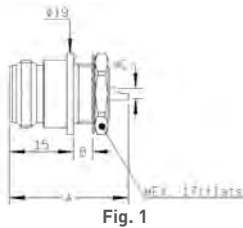

Part number	Fig.	Dimensions (mm)			Captive center contact	Panel drilling	Note
		A	B	C			
R161 570 000	1	28	4.5	2.4	yes	P10	Front mount
R161 606 000	2	34.6	6.5	2.4		Rear mount/fully sealed	
R161 625 000	3	34	6.5	2.5		P11	Front mount/Panel hermetic

Receptacles

N SMT SWITCH AND RECEPTACLE

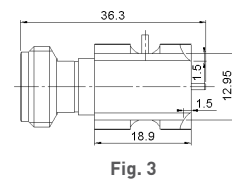
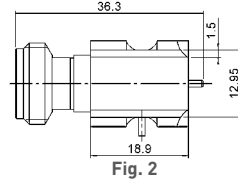
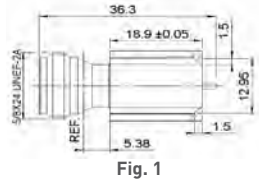

Part number	Fig.	Note
R161 427 223	1	Edge card female receptacle
R161 428 223	2	Edge card SMT left type switch
R161 428 233	3	Edge card SMT right type switch

Adapters

IN SERIES ADAPTERS

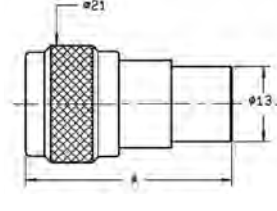
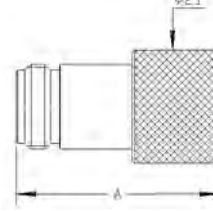
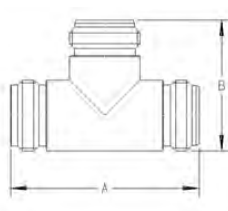
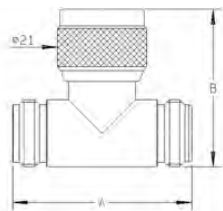
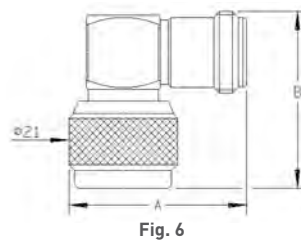
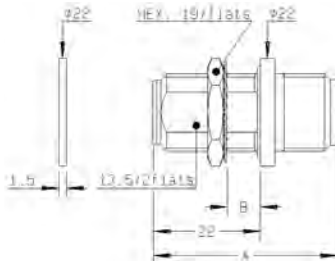
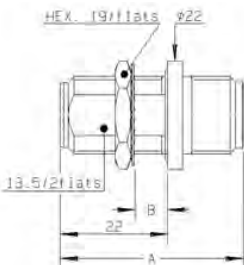
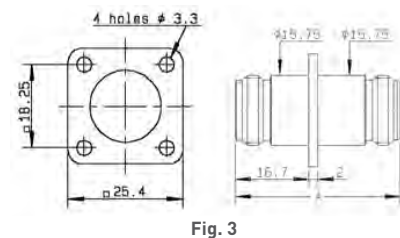
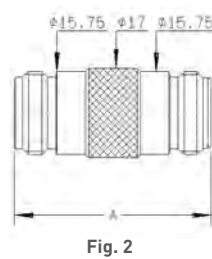
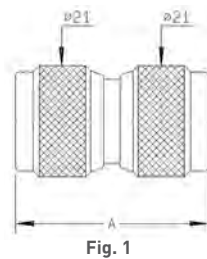

Part number	Fig.	Dimensions (mm)		Panel drilling	Note
		A	B		
R161 703 000	1	36.7			male-male
R161 705 000	2				female-female
R161 715 000	3	37.5		P01	female-female/Flange
R161 730 000	4		6.5	P11	female-female/Bulkhead panel sealed
R161 753 000	5	38	6.5	P11	female-female/Hermetic/bulkhead
R161 771 000	6	34.4	34		male-female/Right-angle
R161 780 000	7	42	36.9		tee female-female/male
R161 782 000	8		29.1		tee female-female/female
R161 791 500	9	37.37			Push-on male/female screwing
R161 791 530	10	37.2			Push-on female/male screwing

Caps and accessories

PROTECTIVE CAPS

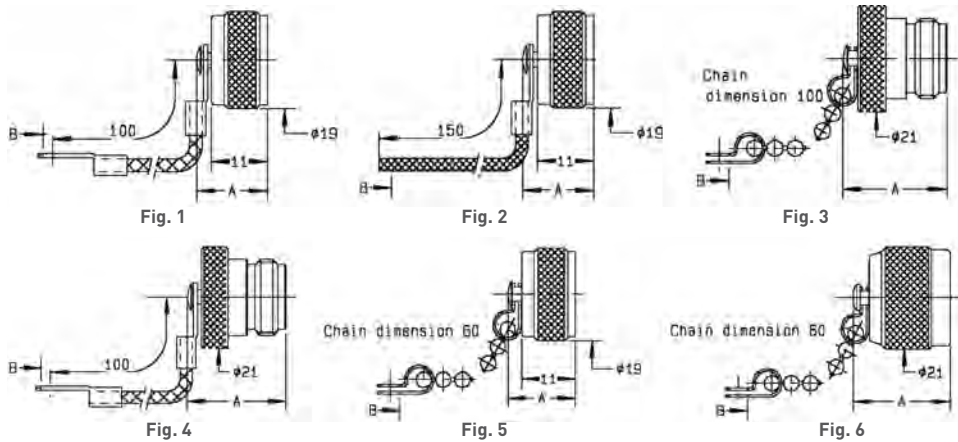

Part number	Fig.	Dimensions (mm)		Note
		A	B	
R161 804 000	1	13.9	3.8	male with cord
R161 805 410	2	13.9	2	male with cord
R161 841 000	3	20.4	3.9	female with chain
R161 844 000	4	20.4	3.8	female with cord
R161 853 000	5	13.9	3.9	male with chain
R161 862 000	6	20.1		male short circuit with chain

FIELD-REPLACEABLE CONTACTS (for universal receptacle)

These accessories have been specifically designed for the adjustment at the rear of hermetically sealed universal receptacles. The choice of their dimensions depends on the PCB or on the thickness of the MIC box. These contacts and insulators are also compatible with SMA UNIVERSAL RECEPTACLES.

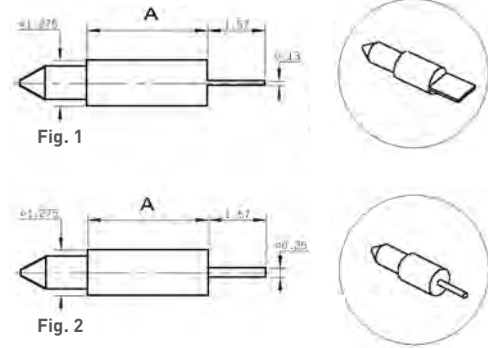
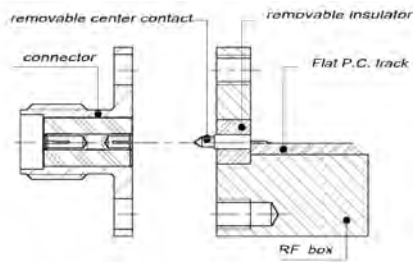

Part number	Fig.	A	Note	Associated insulator P/N
R280 461 000	1		Flat tab	
R280 463 000	2	3.37	Cylindrical tab	R280 468 000

FIELD-REPLACEABLE INSULATOR

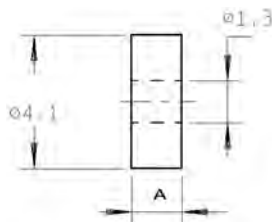

Part number	A	Packaging
R280 468 000	3.17	10

Plugs and jacks

STRAIGHT PLUGS, FOR FLEXIBLE CABLES

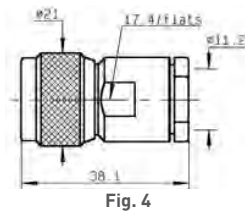
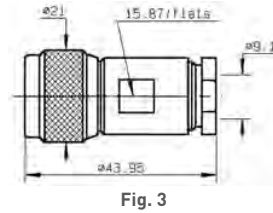
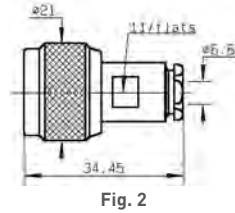
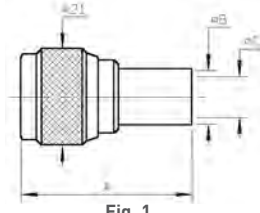

Cable group	Cable group dia.	Part number	Fig.	Dimensions (mm)			Captive center contact	Note
				A	B dia	C dia		
RG59 / RG62	6/75/S	R162 084 000	1	33.9	6.6	4	yes	Crimp type
	6/75+93	R162 012 000	2					
RG6	8/75/D	R162 013 000	3				no	Clamp type
RG11 / RG12 / RG144 / RG216	10+11/75	R162 017 000	4					

STRAIGHT JACKS, CLAMP TYPE, FOR FLEXIBLE CABLES

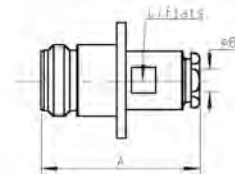
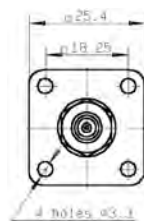
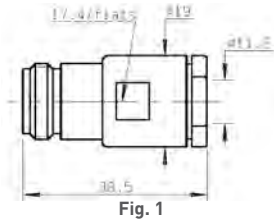

Cable group	Cable group dia.	Part number	Fig.	Dimensions (mm)			Captive center contact	Panel drilling	Note
				A	B	C			
RG11 / RG12 / RG144 / RG216	10+11/75	R162 217 000	1				no		
RG59 / RG62	6/75+93/S	R162 262 000	2	34.9	6.6	11		P01	Square flange

STRAIGHT BULKHEAD JACK, CLAMP TYPE, FOR FLEXIBLE CABLE (panel seal)

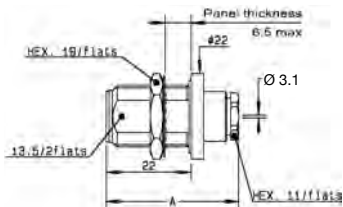

Cable group	Cable group dia.	Part number	Captive center contact	Panel drilling
RG179	2.6/75/S	R162 322 000	no	P11

Receptacles and adapters

FEMALE RECEPTACLES

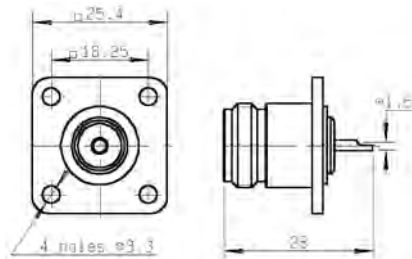

Fig. 1

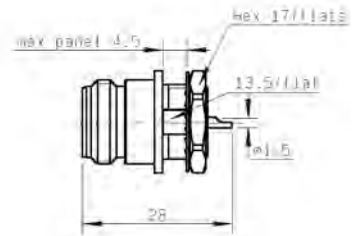

Fig. 2

Part number	Fig.	Captive center contact	Panel drilling
R162 403 000	1	yes	P05
R162 570 000	2		P12

IN SERIES ADAPTERS

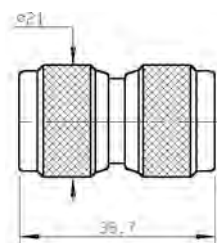

Fig. 1

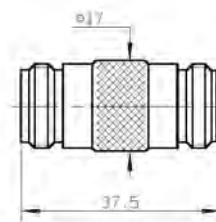
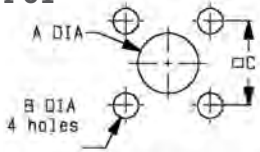

Fig. 2

Part number	Fig.	Captive center contact
R162 703 000	1	yes
R162 705 000	2	

Panel drilling

P01



	MM		INCH	
	maxi	mini	maxi	mini
A	16.3	16.1	0.642	0.634
B	3.30	3.20	0.13	0.126
C	18.35	18.15	0.722	0.715

P02

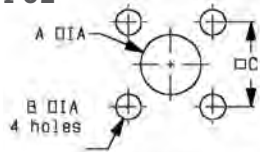

	MM		INCH	
	maxi	mini	maxi	mini
A	15.1	14.9	0.594	0.587
B	3.30	3.20	0.13	0.126
C	18.35	18.15	0.722	0.715

P03

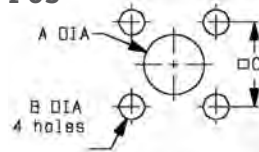

	MM		INCH	
	maxi	mini	maxi	mini
A	9.40	9.20	0.37	0.362
B	3.30	3.20	0.13	0.126
C	12.8	12.6	0.504	0.496

P04

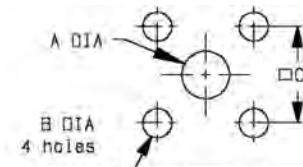

	MM		INCH	
	maxi	mini	maxi	mini
A	4.2	4.1	0.165	0.161
B	3.3	3.2	0.13	0.126
C	18.35	18.15	0.722	0.715

P05

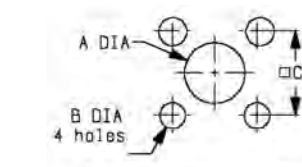

	MM		INCH	
	maxi	mini	maxi	mini
A Front	16.3	16.1	0.642	0.634
A Rear	15.1	14.9	0.594	0.587
B	3.30	3.20	0.13	0.126
C	18.35	18.15	0.722	0.715

P06

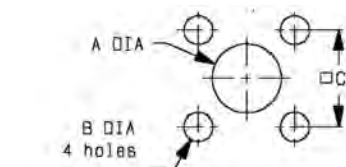

	MM		INCH	
	maxi	mini	maxi	mini
A Front	16.3	16.1	0.642	0.634
A Rear	4.2	4.1	.165	0.161
B	3.3	3.2	0.13	0.126
C	18.35	18.15	0.722	0.715

P07



	MM		INCH	
	maxi	mini	maxi	mini
A Front	16.3	16.1	0.642	0.634
A Rear	12.5	12.3	0.492	0.484
B	3.3	3.2	0.13	0.126
C	18.35	18.15	0.722	0.715

P08



	MM		INCH	
	maxi	mini	maxi	mini
A	4.2	4.1	0.165	0.161
B	2.7	2.6	0.106	0.102
C	8.69	8.59	0.342	0.338

P09

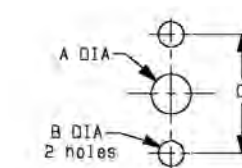

	MM		INCH	
	maxi	mini	maxi	mini
A	5	4.80	0.197	0.189
B	3.30	3.20	0.13	0.126
C	18.1	17.9	0.713	0.705

P10

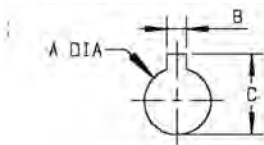

	MM		INCH	
	maxi	mini	maxi	mini
A	14.3	14.1	0.563	0.555
B	2.30	2.20	0.091	0.087
C	17	16.8	0.669	0.661

P11

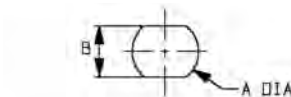

	MM		INCH	
	maxi	mini	maxi	mini
A	16.1	16	0.634	0.63
B	13.7	13.6	0.539	0.535

P12

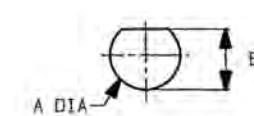

	MM		INCH	
	maxi	mini	maxi	mini
A	14.3	14.1	0.563	0.555
B	13.8	13.6	0.543	0.535

P13

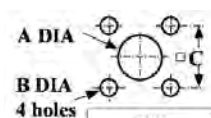

	mm	
	Maxi	mini
A	4.25	4.15
B	3.4	3.2
C	12.8	12.6

Introduction



50Ω	DC - 11 GHz (standard and TNC self-lock) DC - 18 GHz (TNC 18 GHz)
75Ω	DC - 1.5 GHz DC - 1 GHz (recommended)
50 and 75Ω	DC - 1.5 GHz (commercial)

GENERAL

- Screw-on equivalent to BNC bayonet series
- Good RF performance
- Suitable for high power levels
- Long life and high strength
- 4 ranges:
 - Standard TNC series (50 and 75Ω fully intermateable)
 - Commercial TNC series (50 and 75Ω)
 - 18 GHz TNC series (50Ω)
 - TNC selflock series 50 ohms

APPLICABLE STANDARDS

- MIL-C-39012 / MIL STD 348A/313
- IEC 60169-17
- CECC 22200

APPLICATIONS

- Avionics
- Aeronautics
- Countermeasures
- Telecommunications

TNC Self-lock, the latest addition to the TNC range

TNC Self-lock plugs are designed for civil aerospace applications. They are qualified for use in harsh and high vibration environments. Their specific anti-rotation coupling nut eliminates the need for safety lock wire, which results in significant time savings during installation on board the aircraft. They are fully compatible with all standard TNC receptacles and adapters.

Interface TNC

TNC

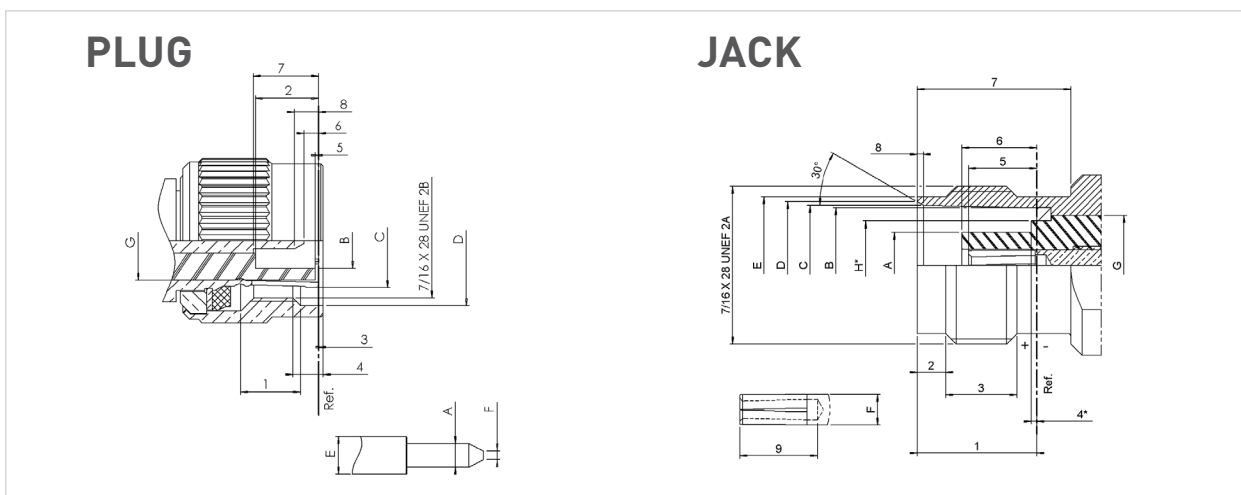

Letter	mm		inch	
	min.	max.	min.	max.
A	1.32	1.37	0.052	0.054
B	4.83	-	0.190	-
D	11.40	-	0.449	-
E	-	2.20	-	0.087
F	0.35	0.65	0.014	0.025
G	7.00	7.05	0.275	0.277
1	4.9	5.70	0.193	0.224
2	5.28	5.79	0.208	0.228
3	0.15	-	0.006	-
4	1.8	-	0.071	-
5	0.15	-	0.006	-
6	0.08	1.02	0.003	0.040
7	5.33	5.84	0.210	0.230
8	0.70	1.98	0.027	0.078

Letter	mm		inch	
	min.	max.	min.	max.
A	-	4.72	-	0.186
B	8.10	8.10	0.319	0.321
C	8.31	8.46	0.327	0.333
D	8.79	9.04	0.346	0.356
E	9.60	9.68	0.378	0.381
F	-	2.20	-	0.087
H	-	5.90	-	0.232
1	8.30	8.50	0.327	0.335
2	1.73	2.24	0.068	0.088
3	4.75	-	0.187	-
4	-	0.15	-	0.006
5	4.72	5.23	0.186	0.206
6	4.78	5.28	0.188	0.208
7	10.7	-	0.421	-
8	0.38	0.76	0.015	0.030
9	4.95	-	0.195	-

Characteristics TNC

Test / Characteristics	MIL-C-39012 A	Values / Remarks
------------------------	---------------	------------------

ELECTRICAL CHARACTERISTICS

Impedance		50Ω	75Ω
Frequency range		DC - 11 GHz	DC - 1.5 GHz
V.S.W.R.	3-14	1.30 max	
Insertion loss	3-27	0.18 dB max at 9 GHz	
RF leakage	3-26	-60 dB min from 2 to 3 GHz	
Insulation resistance	3-11	5000 MΩ min	
Contact resistance	3-16	Initial	After proof
• Center contact (mΩ)		1.5	2
• Outer contact (mΩ)		0.2	-
Working voltage		At sea level: 500 V rms	at 70000 ft (21000 m): 125 V rms
Dielectric withstanding voltage	3-17	At sea level: 1500 V rms	at 70000 ft (21000 m): 375 V rms
RF withstanding voltage	3-23	At sea level: 1000 V rms (5 MHz sine wave)	

MECHANICAL CHARACTERISTICS

Durability	3-15	500 matings	
Mating / unmating		axial force: not applicable torque: 1.96 inch pounds (22.6 N.cm)	
Recommended mating torque		3.99 to 5.98 inch pounds (46 to 69 N.cm)	
Proof torque		14.74 inch pounds (170 N.cm)	
Coupling mechanism retention force	3-25	100 Lbf (44.5 daN)	
Cabling retention force	3-24	cable clamp:	40.6 Lbf (181 N min) [all cables]
		crimped:	51 Lbf (227 N min) [cable dia. .189 (4.8) to .228 (5.8)] 76.4 Lbf (340 N min) [cable dia. .250 (6.35) and above]
Center contact retention		Axial: 6.06 Lbf (27 N)	

ENVIRONMENTAL CHARACTERISTICS

Temperature range		-65°C / + 165°C -65°C / +100°C -65°C / +105°C	
• Standard models			
• Hermetic sealed models			
• Models for semi-rigid cables			
Thermal shock	3-20	MIL-STD-202, method 107, condition B	
High temperature endurance		MIL-STD-202, method 108	
Corrosion (salt spray)	3-13	MIL-STD-202, method 101, condition B	
Vibrations	3-18	MIL-STD-202, method 204, condition B	
Shocks	3-19	MIL-STD-202, method 213, condition G	
Moisture resistance	3-21	MIL-STD-202, method 106	
Low pressure	3-22	Not applicable	
Hermetic seal		Applied vacuum 10 ⁻⁶ mm of Hg (Torrs) leakage rate < 10 ⁻⁶ atm/cm ³ /s	
Leakage		Pressure 3.5 bars; duration 2 mn; temperature 15°C to 25°C	

MATERIALS AND PLATING

Body and center pin contact	Brass as per QQ-B-626	Nickel plated
Center socket contact	Beryllium copper as per QQ-C-530	Gold plated
Ferrules	Brass	
Insulators	PTFE teflon	
Gaskets	Silicone elastomer	

All dimensions are given in mm.

Characteristics commercial TNC

Test / Characteristics	Values / Remarks
------------------------	------------------

ELECTRICAL AND ENVIRONMENTAL CHARACTERISTICS

Impedance	50Ω or 75Ω
Frequency range	DC - 1.5 GHz
Test voltage	1500 V rms
Operating voltage	500 V rms
Insulation resistance	5000 MΩ min (500 V)
Contact resistance	10 mΩ max
Temperature range	-35°C / +70°C

PLATING

Body	Nickel
Center contacts	Gold

Plugs

STRAIGHT PLUGS CRIMP TYPE FOR FLEXIBLE CABLE

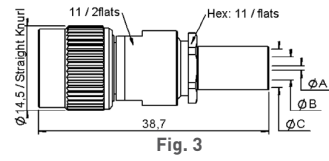
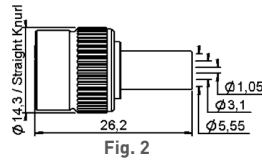
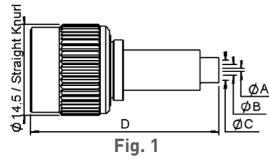

Cable group	Cable group dia.	Part number	Fig.	Dimensions mm				Captive center contact	Packaging	Note
				A	B	C	D			
RG174/RG316/AEP-100FR	2.6/50/S & LMR® 100	R143 075 000	1	0.6	1.75	3.25	29.6	yes	100 pieces	Crimp type
AEP-195FR	LMR® 195	R143 082 027		1.05	3.1	5.55	26.6			
AEP-200FR	LMR® 200	R143 082 200		1.27	3.1	5.55	26.6			
AEP-240FR	LMR® 240	R143 084 161		1.5	4.05	6.6	28.2			
AEP-400FR	LMR® 400	R143 089 117		2.85	7.8	11.05	27.85			
RG58/RG141	5/50/S	R143 082 000	2					no	Unit	Full crimp
		R143 082 161								Commercial version, full crimp
		R143 072 000	3	1.05	3.1	5.55				
RG142/RG223/RG400	5/50/D	R143 073 000	1	1.05	3.075	5.5		yes	Unit	
		R143 083 000		1.05	3.1	5.5	26.6			

STRAIGHT PLUGS CLAMP TYPE FOR FLEXIBLE AND SEMI RIGID CABLE

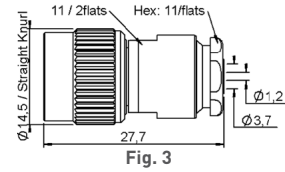
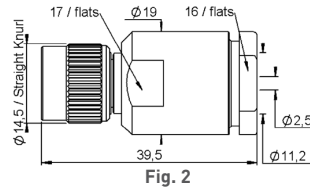
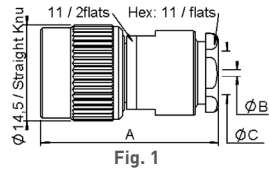

Cable group	Cable group dia.	Part number	Fig.	Dimensions mm			Captive center contact	Packaging	Note
				A	B	C			
RG174/RG316/RD316 RG179/RD179	2.6/50+75	R143 004 000	1	26.5	0.6	3.1	yes	Unit	Conical braid clamp
RG58/RG141/RG142 RG223/RG400	5/50/S+D	R143 008 000		27.1	1.2	5.6	no	100 pieces	
RG59/RG62	6/75+93	R143 012 000		27	1.05	6.65	yes	Unit	
RG213/RG393/RG214	10+11/50	R143 018 000	2						Safety coupling nut
RG402	.141"	R143 052 000		3				no	

Plugs and jacks

RIGHT ANGLE PLUGS CRIMP AND SOLDER TYPE

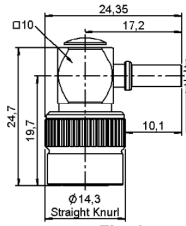

Fig. 1

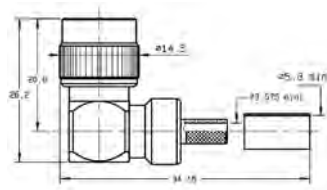

Fig. 2

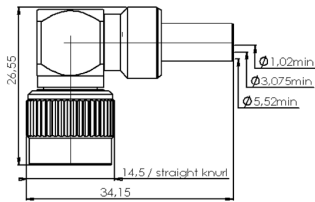

Fig. 3

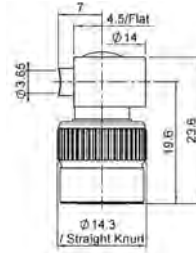
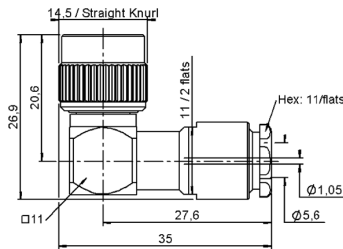

Fig. 4

Cable group	Cable group dia.	Part number	Fig.	Captive center contact	Packaging	Note
RG174/RG316	2.6/50/S	R143 181 161	1	yes	100 pieces	Commercial version
RG58/RG141	5/50/S	R143 182 000	3		Unit	
RG142/RG223/RG400	5/50/D	R143 183 000	2		100 pieces	Solder Type
RG402	.141"	R143 154 100	4			

RIGHT ANGLE PLUG CLAMP TYPE FOR FLEXIBLE CABLE



Cable group	Cable group dia.	Part number	Captive center contact	Packaging
RG58/RG141/RG142/RG223/RG400	5/50/S+D	R143 156 000	yes	Unit

STRAIGHT JACKS CRIMP TYPE FOR FLEXIBLE CABLE

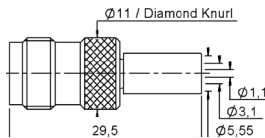

Fig. 1

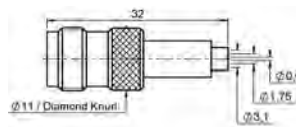

Fig. 2

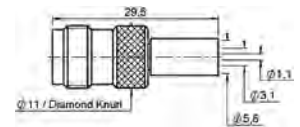
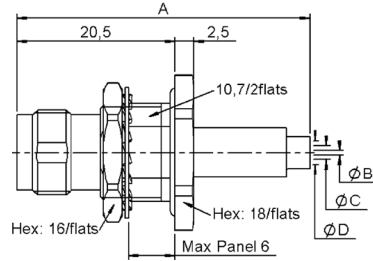

Fig. 3

Cable group	Cable group dia.	Part number	Fig.	Captive center contact	Packaging	Note
RG174/RG316/RD316	2.5/60 S + D	R143 237 000	2	yes	Unit	
RG58/RG141	5/50/S	R143 235 161	1		100 pieces	Commercial version, full crimp
RG142/RG223/RG400	5/50D	R143 236 020	3		Unit	

Jacks

STRAIGHT BULKHEAD JACKS CRIMP TYPE FOR FLEXIBLE CABLE



Cable group	Cable group dia.	Part number	Dimensions mm				Captive center contact	Panel drilling	Packaging	Note
			A	B	C	D				
RG174/RG316	2.6/50/S	R143 331 161	38	0.6	1.75	3.10	yes	P08+P10	100 pieces	Commercial version, panel sealed
RG58/RG141	5/50/S	R143 332 161	35	1.05	3.10	5.55				Commercial version, panel sealed, full crimp

STRAIGHT JACKS CLAMP TYPE FOR FLEXIBLE CABLE

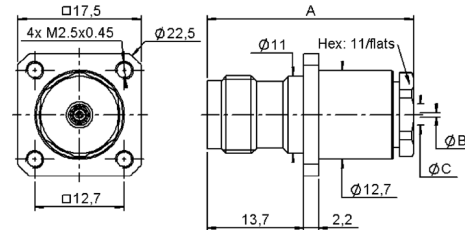

Fig. 1

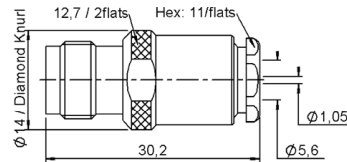
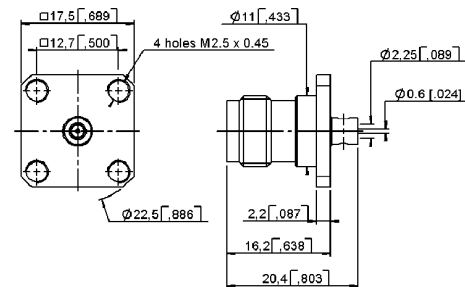

Fig. 2



Cable group	Cable group dia.	Part number	Fig.	Dimensions mm			Captive center contact	Panel drilling	Packaging	Note
				A	B	C				
RG174/RG316/RD316/RG179/RD179	2.6/50+75	R143 254 000	1	29.8	0.6	3.1	yes	P04	Unit	Square flange Also for screws type 3-56 UNF 2A
RG58/RG141/RG142/RG223/RG400	5/50/S+D	R143 258 000		30.2	1.05	5.6	no			
RG58/RG141	5/50/S	R143 207 000	2							

SQUARE FLANGE STRAIGHT JACK SOLDER TYPE FOR SEMI-RIGID CABLE



Cable group	Cable group dia.	Part number	Captive center contact	Panel drilling	Packaging
RG405	.085"	R143 257 440	no	P01	Unit

Jacks and receptacles

STRAIGHT BULKHEAD JACKS PANEL SEALED

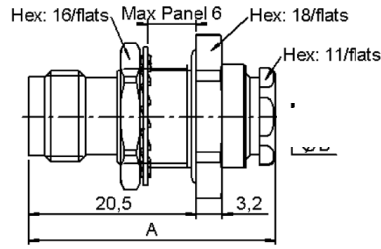

Fig. 1

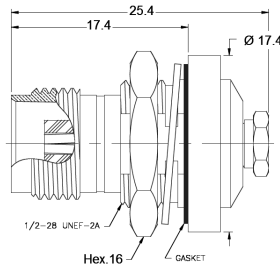

Fig. 2

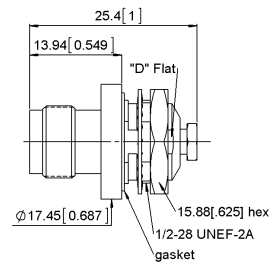

Fig. 3

Cable group	Cable group dia.	Part number	Fig.	Dimensions A (mm)	Captive center contact	Panel drilling	Note
RG178 / RG196	2/50/S	R143 323 000	1	29.9	yes	P08	Rear mount
RG174 / RG316 / RD316	2.6/50	R143 324 000		29.6			
RG58 / RG141	5/50/S	R143 325 000		30.17			
RG402	.141"	R143 337 000		30.8			
RG174 / RG316	2.6/50S	6001-7051-003	2		yes		Front mount
RG405	.085"	6001-7041-010					
RG178 / RG196	2/50S	6002-7051-002	3		yes		
RG178 / RG196	2/50S	6002-7551-202					
RG174 / RG316	2.6/50S	6002-7051-003					
RD316	2.6/50D	6002-7551-219					
RG58 / RG141	5/50S	6002-7551-106					

SQUARE FLANGE STRAIGHT FEMALE RECEPTACLES

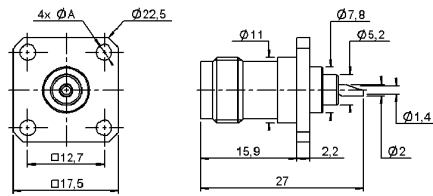

Fig. 1

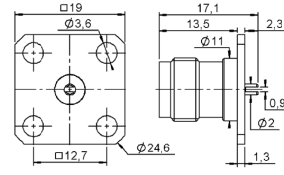

Fig. 2

Part number	Fig.	Dimensions A (mm)	Captive center contact	Panel drilling	Packaging	Note
R143 404 000	1	M2.5 x 0.45	yes	P05	Unit	Solder pot 17.5 mm square flange
R143 405 000		2.6			100 pieces	
R143 420 000	2		no	P02		Slotted contact 19 mm square flange

BULKHEAD STRAIGHT FEMALE RECEPTACLES

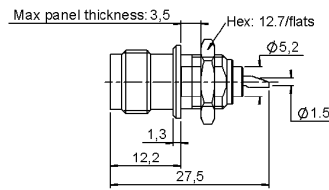

Fig. 1

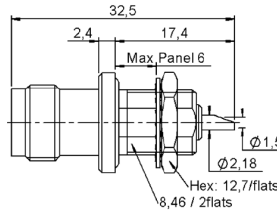

Fig. 2

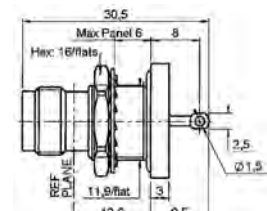
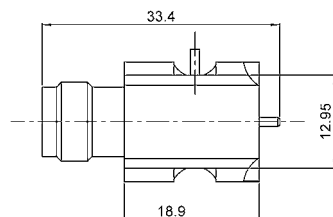

Fig. 3

Part number	Fig.	Captive center contact	Panel drilling	Packaging	Note
R143 557 000	1	yes	P07	Unit	Front mount, solder pot contact
R143 603 000	2		P09		Panel sealed, front mount, solder pot contact
R143 626 000	3		P11		Hermetic, panel sealed, rear mount

Receptacles and caps

RF POWER SWITCHING CONNECTORS



Part number	Type
R143 422 947	Left
R143 422 957	Right

SQUARE FLANGE RIGHT ANGLE FEMALE RECEPTACLE

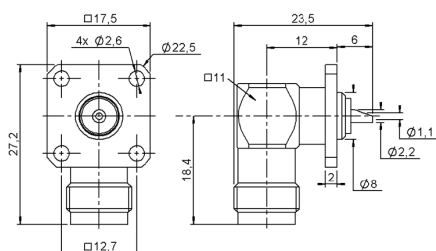

Part number	Captive center contact	Panel drilling	Packaging	Note
R143 654 000	yes	P06	Unit	Solder pot contact

SQUARE FLANGE STRAIGHT MALE RECEPTACLE

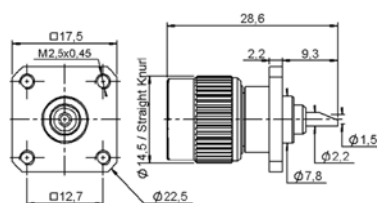

Part number	Captive center contact	Panel drilling	Packaging	Note
R143 440 000	yes	P03	Unit	Solder pot contact

PROTECTIVE CAPS

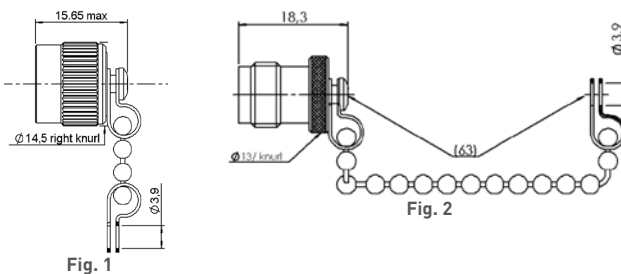

Part number	Fig.	Finish	Packaging	Note
R143 812 000	1	Nickel	Unit	male with chain
R143 835 000	2		100 pieces	female with chain

Adapters

IN SERIES ADAPTERS

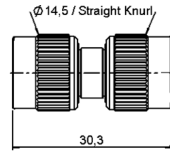

Fig. 1

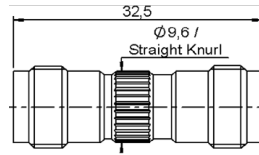

Fig. 2

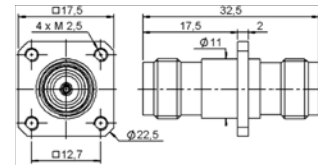

Fig. 3

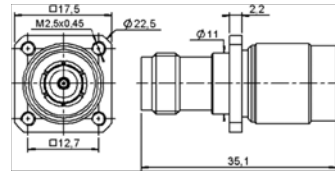

Fig. 4

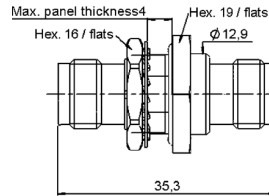

Fig. 5

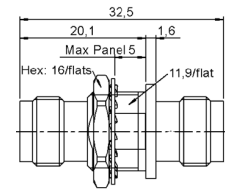

Fig. 6

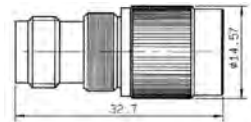

Fig. 7

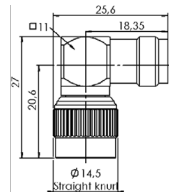

Fig. 8

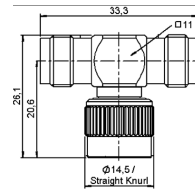

Fig. 9

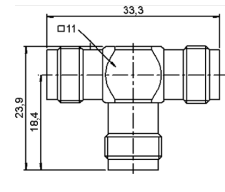
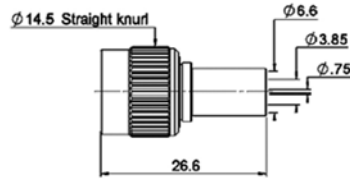

Fig. 10

Part number	Fig.	Captive center contact	Panel drilling	Packaging	Note
R143 703 000	1	yes	P01	Unit	male-male
R143 704 000	2				female-female
R143 710 000	3				Square flange female-female
R143 713 000	4			Square flange slide on type male-female	
R143 753 000	5			Bulkhead hermetic, panel sealed female-female	
R143 720 000	6			Commercial version, bulkhead female-female	
R143 713 200	7			female-male push-on	
R143 770 000	8			Right angle male-female	
R143 780 000	9			female female male	
R143 782 000	10			female female female	

Plugs and jacks

STRAIGHT PLUGS CRIMP TYPE FOR FLEXIBLE CABLE



Cable group	Cable group dia.	Part number	Captive center contact	Note
RG59 / RG62	6/75 + 93	R144 085 000	no	Full crimp
		R144 085 161	yes	Commercial version - full crimp

STRAIGHT BULKHEAD JACK CRIMP TYPE FOR FLEXIBLE CABLE

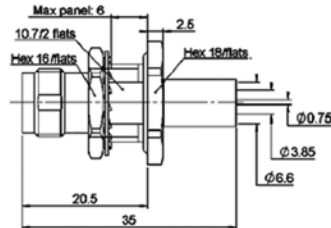

Cable group	Cable group dia.	Part number	Captive center contact	Panel drilling	Packaging	Note
RG59 / RG62	6/75 + 93	R144 334 161	yes	P08 or P10	100 pieces	Commercial version Panel sealed

Panel drilling

P01

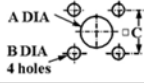

	MM		INCH	
	maxi	mini	maxi	mini
A	11.3	11.2	0.445	0.441
B	2.7	2.6	0.106	0.102
C	12.75	12.65	0.502	0.498

P02

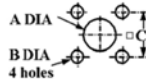

	MM		INCH	
	maxi	mini	maxi	mini
A	11.3	11.2	0.445	0.441
B	3.7	3.6	0.146	0.142
C	12.75	12.65	0.502	0.498

P03

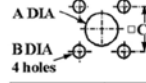

	MM		INCH	
	maxi	mini	maxi	mini
A	7.9	7.8	0.311	0.307
B	2.7	2.6	0.106	0.102
C	12.75	12.65	0.502	0.498

P04

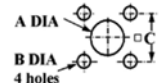

	MM		INCH	
	maxi	mini	maxi	mini
A (F. Mount)	13	12.9	0.512	0.508
A (R. Mount)	11.3	11.2	0.445	0.441
B	2.7	2.6	0.106	0.102
C	12.75	12.65	0.502	0.498

P05

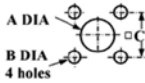

	MM		INCH	
	maxi	mini	maxi	mini
A F.mount	8	7.9	0.315	0.311
A R.mount	11.3	11.2	0.445	0.441
B	2.8	2.7	0.11	0.106
C	12.75	12.65	0.502	0.498

P06



	MM		INCH	
	maxi	mini	maxi	mini
A	8.3	8.2	0.327	0.323
B	2.7	2.6	0.106	0.102
C	12.75	12.65	0.502	0.498

P07



	MM		INCH	
	maxi	mini	maxi	mini
A	9.8	9.7	0.386	0.382
B	8.93	8.81	0.352	0.347

P08



	MM		INCH	
	maxi	mini	maxi	mini
A	12.8	12.7	0.504	0.5
B	12.1	12	0.476	0.472

P09

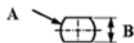

	MM		INCH	
	maxi	mini	maxi	mini
A	9.75	9.65	0.384	0.38
B	8.65	8.55	0.341	0.337

P10

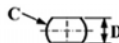

	MM		INCH	
	maxi	mini	maxi	mini
C	12.8	12.7	0.504	0.5
D	10.9	10.8	0.429	0.425

P11

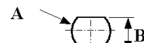

	mm	
	Maxi	mini
A	12.9	12.8
B	12.1	12

Introduction



50Ω	DC - 11 GHz (maximum) DC - 3 GHz (optimized)
-----	---

GENERAL

- Standard coaxial connectors
- Bayonet coupling

APPLICABLE STANDARDS

- MIL-C-39012 A
- MIL-C-3898 A
- MIL-C-23329 A
- IEC 169-7

APPLICATIONS

- Civil aerospace
- Maintenance

Type C Connectors were engineered in the late 1940s. It is similar to type N but with a bayonet coupling for rapid connection and disconnection.

Interface

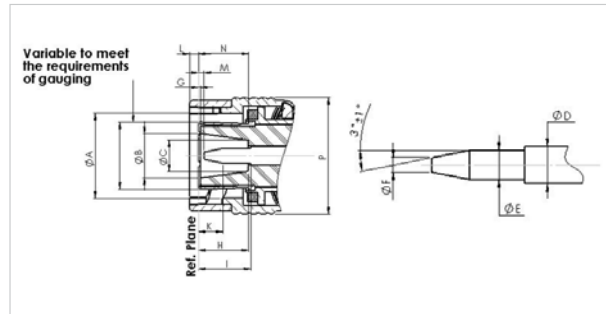
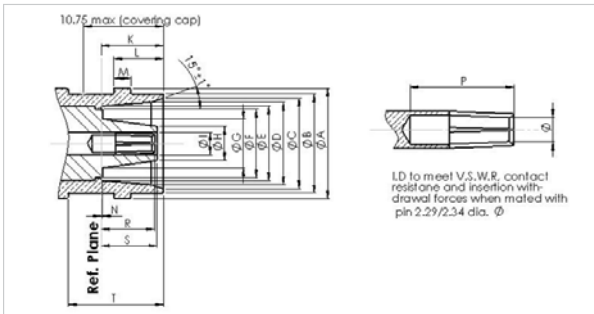

CEI Dimensions (in mm)

	Jack			Plug	
	min	max		min	max
ØA	14.99	15.24	ØA	13.79	13.94
ØB	13.46	13.72	ØB	7.01	-
ØC	12.32	12.57	ØC	4.92	-
ØD	11.18	11.43	ØD	3.02	3.15
ØE	10.44	10.54	ØE	2.29	2.34
ØF	-	9.50	ØF	-	1.27
ØG	-	6.91	ØG	0.18	-
ØH	-	4.83	ØH	7.80	8.56
ØI	3.02	3.15	ØI	7.85	-
K	8.43	8.59	K	4.85	6.38
L	7.80	7.95	L	-	2.16
M	2.24	2.49	M	0.09	1.02
N	-	0.18	N	7.54	7.72
P	7.62	-	P	-	19.84
Q	-	-			
R	6.93	7.70			
S	-	7.85			
T	12.57	-			

Characteristics

Test / Characteristics	Values / Remarks
------------------------	------------------

ELECTRICAL CHARACTERISTICS

Impedance	50Ω
Frequency range	DC - 3 GHz (optimized) DC - 11 GHz (maximum)
V.S.W.R.	1.22 at 3 GHz
Test voltage at sea level	3 Kv continuous
Insulation resistance	> 5000 MΩ

MECHANICAL CHARACTERISTICS

Durability	500 matings
Vibrations	10g (acceleration) 10 to 500 Hz

ENVIRONMENTAL CHARACTERISTICS

Temperature range	-55°C / + 155°C
Salt spray	48H
Panel sealing	Pressure: 3 bars Leakage rate < 1 cm³/h

MATERIALS AND PLATING

Component	Materials	Plating
Outer contact	Bronze	Gold
Connector body	Brass / Stainless steel	Nickel / Passivated
Insulator	PTFE	
Gaskets	Silicone rubber	

Plugs and jacks

STRAIGHT PLUGS FOR FLEXIBLE CABLE

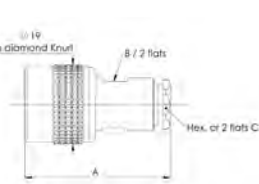

Fig. 1

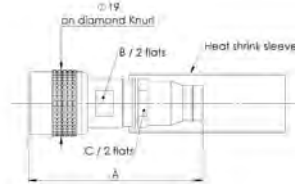

Fig. 2

Cable group	Cable group dia.	Part number	Fig.	Dimensions			Captive center contact	Note
				A	B	C		
RG58 / RG141	5/50/S	R166 005 000	1	35	11	11	no	Clamp type
RG213 / RG214	10/50/S 11/50/D	R166 018 000	1	38	16	16		
ASNE WD+WN	8/50	R166 092 190	2	50.25	12	12	yes	Crimp type
F1703-93	4.3/50/D	R166 093 000		49.5	10	8	no	
Special ASNE	5/50/D	R166 094 000		46.45	12	12		
ASNE WZ	3.6/50S	R166 088 100		42.55	12	8		

RIGHT ANGLE PLUGS FOR FLEXIBLE CABLE

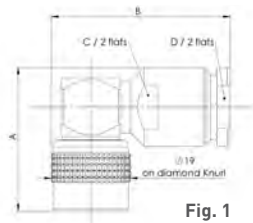

Fig. 1

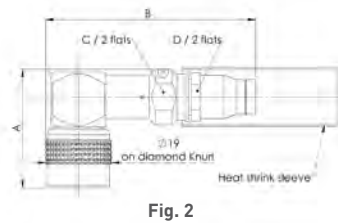

Fig. 2

Cable group	Cable group dia.	Part number	Fig.	Dimensions				Captive center contact	Note
				A	B	C	D		
Special	7/50/D	R166 160 020	1	31.3		15.8	16	yes	Clamp type
RG213 / RG214	10/50/S 11/50/D	R166 168 000		34.5	43	16	16		
F1703-93	4.3/50/D	R166 191 000	2	34.3	52.6	14	12		Crimp type
ASNE WD+WN	8/50	R166 194 190		34.3	60.8	14	12		

STRAIGHT JACKS FOR FLEXIBLE CABLE

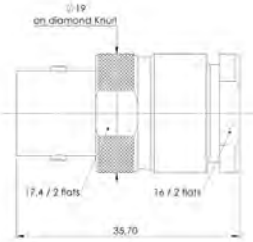

Fig. 1

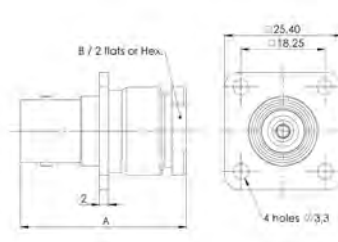
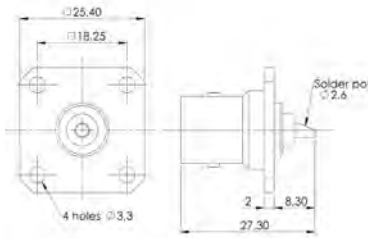

Fig. 2

Cable group	Cable group dia.	Part number	Fig.	Dimensions		Captive center contact	Note
				A	B		
RG213 / RG214	10/50/S 11/50/D	R166 218 000	1			no	Clamp type
Special ASNE	5/50/D	R166 256 000	2	32	12.7		
RG213 / RG214	10/50/S 11/50/D	R166 268 000			35.7	19	

Receptacles and In Series adapters

SQUARE FLANGE, STRAIGHT FEMALE RECEPTACLES



Part number	Captive center contact	Panel drilling	Finish
R166 404 000	yes	P01	Brass / Nickel
R166 404 001			Stainless steel passivated

IN SERIES ADAPTERS

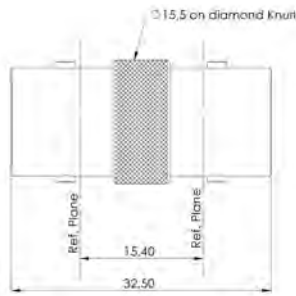

Fig. 1



Fig. 2

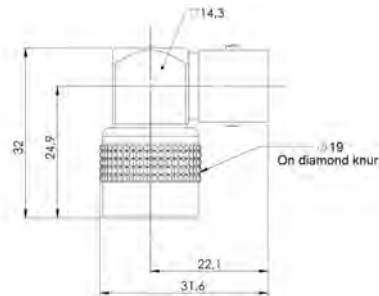
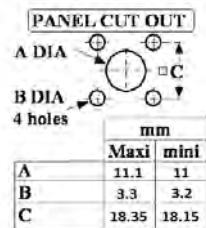

Fig. 3

Part number	Fig.	Panel drilling	Note
R166 705 000	1		female - female
R166 753 000	2	P02	female - female / bulkhead / hermetic
R166 770 000	3		male - female / right angle

Panel drilling

P01



P02

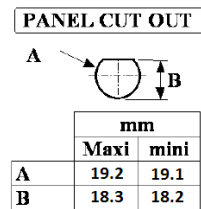

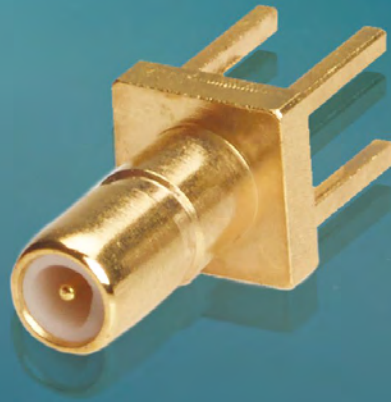

SSMA / SSMB / SSMC

R121 / R203 / R202



Contents

SSMA

Introduction 12-4
Characteristics 12-4
Plugs 12-5
Receptacles 12-6
In series adapters 12-6

SSMB

Introduction 12-7
Characteristics 12-7
Plugs and jacks 12-8 to 12-9
Receptacles 12-9 to 12-11
In series adapters 12-11
Panel drilling 12-15

SSMC

Introduction 12-12
Characteristics 12-12
Plugs and jacks 12-13 to 12-14
Receptacles 12-14
In series adapters 12-14
Panel drilling 12-15

Introduction



50Ω	DC - 18 GHz
DC-34 GHz possible	

GENERAL

- Miniature coaxial connectors
- Screw-on coupling
- High RF performance
- Reduced weight and size

APPLICATIONS

- Military aeronautics
- Missiles
- Detection - countermeasures

APPLICABLE STANDARDS

- CECC 22 160
- MIL-STD-348 fig.319

SPACE QUALIFIED APPROVAL

- SCC 3402 (ESA)

Introduced in the 1960s, the SSMA series of connectors are of identical construction to the classic SSMA series but offer the benefit of reduced dimensions. They are recommended for use on equipment having limited component space availability combined with frequency requirements up to 34 GHz. Today, SSMA is mostly used for maintenance of existing equipment. For new projects, we advise using SMP or SMP-LOCK™ connectors.

Characteristics

Test / Characteristics	Values / Remarks
------------------------	------------------

ELECTRICAL CHARACTERISTICS

Impedance	50Ω	
Frequency range	DC - 18 GHz	
VSWR	.085" / RG405 semi-rigid cable: 1.07 + 0.01 F (GHz)	
Insertion loss (typ.) dB	0.04 √F (GHz)	
RF leakage (min) dB	-90 + F (GHz)	
Insulation resistance	≥ 1000 MΩ	
Contact resistance	Center contact: 5mΩ max. / Outer contact: 2.5mΩ max.	
Voltage in V. Rms	Dielectric withstanding voltage	Working voltage
• At sea level	≥ 750 V.	≤ 250 V.
• At 70,000 ft	150 V.	65 V.

MECHANICAL CHARACTERISTICS

Durability	> 500 cycles
Force to engage / disengage	Torque 12 N.com (2 inch-pounds)
Recommended coupling not torque	60 to 80 N.com (5.3 to 7.1 inch-pounds)
Cable retention force	.085: / RG405 cable > 136 N (30lbf)
Center contact retention force	22N (5lbf) min.

ENVIRONMENTAL CHARACTERISTICS

Temperature range	- 55°C / +155°C • Standard models • Semi-rigid cables
Thermal cycling	MIL-STD-202, Method 102, Condition D
Vibration	MIL-STD-202, Method 204, Condition A, 10g
Shock	MIL-STD-202, Method 213, Condition A, 50g
Moisture resistance	MIL-STD-202, Method 106
Corrosion	MIL-STD-202, Method 101, Condition B

MATERIALS AND PLATING

	Material	Plating
Body/nut	Stainless steel / Brass	Gold or Passivated / BBR
Center contacts	Brass (male) / Beryllium copper (female)	Gold over Nickel
Gaskets	Silicon rubber	
Insulators	PTFE	

Plugs

PLUGS FOR SEMI-RIGID CABLES, SOLDER TYPE

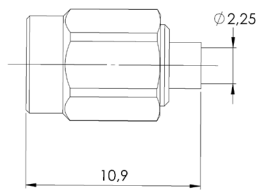

Fig. 1

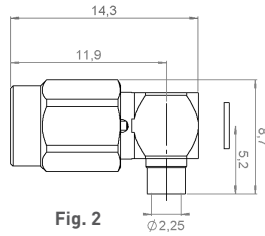

Fig. 2

Cable group	Cable group dia.	Part number (Gold)	Fig.	Captive center contact	Note
RG405	.085"	R121 053 000	1	yes	Straight
		R121 153 000	2		Right angle

PLUGS FOR FLEXIBLE CABLE, CRIMP TYPE

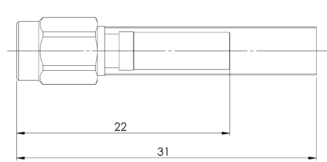

Fig. 1

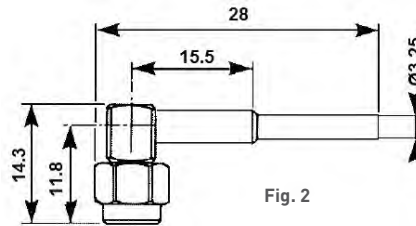

Fig. 2

Cable group	Cable group dia.	Part number (Gold)	Fig.	Captive center contact	Note
RG174 / RG316	2.6/50S	R121 072 000	1	yes	Straight - heatshrink sleeve
		R121 172 000	2		Right angle - heatshrink sleeve
		9765-9523-003			Right angle

Receptacles and adapters

EXTENDED DIELECTRIC FEMALE RECEPTACLE

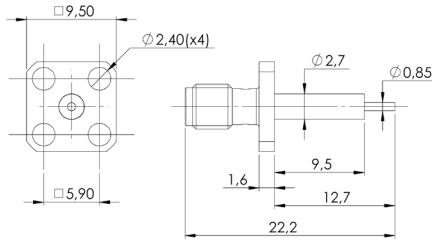
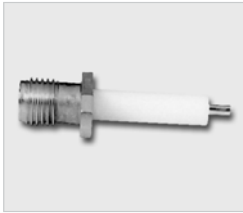

Fig. 1

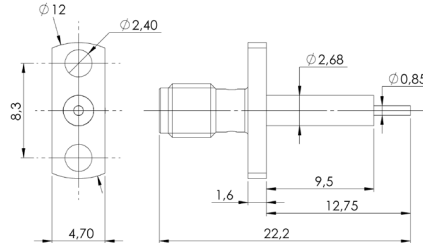
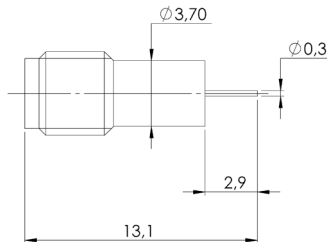
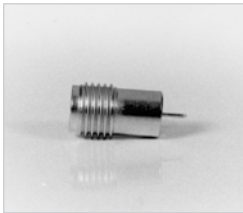

Fig. 2

Part number (Gold)	Fig.	Captive center contact	Panel drilling	Note
R121 414 000	1	yes (epoxy)	NEW	Square flange
R121 464 000	2			Narrow flange

HERMETIC FEMALE RECEPTACLE



Part number (gold)	Captive center contact	Contact type	Note
R121 630 003	yes	Cylindrical	Solder in type

IN SERIES ADAPTERS

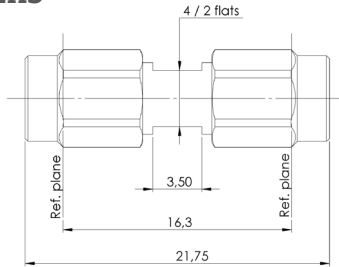

Part number (Gold)	Part number (Passivated)	Captive center contact	Finish	Note
R121 703 000	R121 705 001	yes	Nickel	male-male adapter
			Gold	female-female adapter

Introduction



GENERAL

- DC - 12 GHz
- Impedance 50Ω
- Snap-on coupling
- Microminiature connectors
- Very low weight and size

APPLICATIONS

- Civil and military telecommunications
- Video equipment

APPLICABLE STANDARDS

- MIL-STD-348A
- IEC 169-19
- MIL-PRF-39012

SSMB is a small size version of SMB, developed in 1995.

Characteristics

Test / Characteristics	Values / Remarks
------------------------	------------------

GENERAL

Impedance	50Ω
Frequency range	DC - 12.4 GHz
Temperature range	-65°C to + 165°C

ELECTRICAL CHARACTERISTICS

Insertion loss in dB	0.3VF (GHz)	
RF leakage	≤ -55 dB at 1 GHz	
VSWR	RG 178 cable: 1.25 + 0.02F (GHz)	
Contact resistance	Center contact: 5mΩ max. Outer contact: 1mΩ max.	
Insulation resistance	1000MΩ	
Voltage in VRMS • At sea level • At 70,000 ft	Dielectric withstanding voltage ≥ 500V 100V	Working voltage ≤ 250V 60V

MECHANICAL CHARACTERISTICS

Cable retention force	RG 174 : 50 N - RD 316 : 100 N
Mating endurance	500
Center contact retention force	≥ 8 N
• Force to engage • Force to disengage	≤ 27 N ≥ 8 N

ENVIRONMENTAL CHARACTERISTICS

Vibration	CEI60 169-19/68-2-6 (10g-10 to 500 Hz)
Shock	MIL-STD-202, Method 213, Condition B, 75g-6ms 1/2 sinus
Corrosion (salt mist)	MIL-STD-202, Method 101, Condition B (48h)

MATERIALS AND PLATING

	Material	Plating
Body	Brass	Gold
Contacts	Beryllium copper	Gold
Insulators	PTFE	

Plugs

STRAIGHT PLUGS CRIMP TYPE FOR FLEXIBLE CABLES

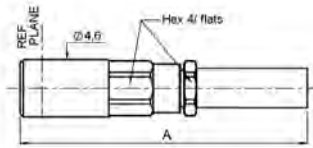

Cable group	Cable group dia.	Part number	Dimensions A (mm)	Captive center contact	Finish
RG178 / RG196	2/50S	7202-1572-002	17.8	yes	Gold
RG174 / RG316 / RG179	2.6/50S	7202-1572-003			
RD316	2.6/50D	7202-1572-019			
RG178 / RG196	2/50/S	R203 073 000	23.3		
RG174 / RG316	2.6/50/S	R203 075 000			

STRAIGHT PLUGS, SOLDER TYPE FOR SEMI-RIGID CABLES

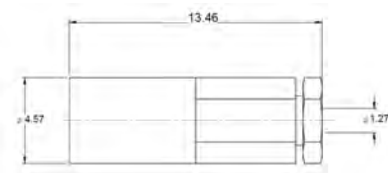

Cable group	Cable group dia.	Part number	Captive center contact	Finish
RG405	.085"	7202-1542-010	yes	Gold
M17 / 151	.047"	7202-1542-011		

RIGHT ANGLE PLUGS, CRIMP TYPE FOR FLEXIBLE CABLES

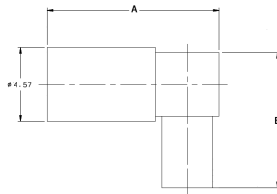

Cable group	Cable group dia.	Part number	Dimensions (mm)		Captive center contact	Finish	Note
			A	B			
RG178 / RG196	2/50S	7405-1521-002	10.7	8.4	yes	Gold	
RG174 / RG316	2.6/50S	7405-1521-003					
RD178	2/50D	7405-1521-005					
RD316	2.6/50D	7405-1521-019					
RG178 / RG196	2/50S	7405-2521-002				Gold + Nickel	
		R203 173 000	18.1	12.2	Gold	Heatshrink sleeve	
		R203 173 080	10.7	9.4	Gold	Low profile	
RG316	2.6/50+75	R203 175 000	12.2	13.6			Heatshinks sleeve

Plugs, jacks and receptacles

RIGHT ANGLE PLUGS, SOLDER TYPE FOR SEMI RIGID CABLES

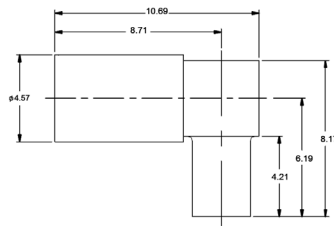

Cable group	Cable group dia.	Part number	Captive center contact	Finish
RG405	.085"	7405-1561-010	yes	Gold
M17 / 151	.047"	7405-1561-011		

STRAIGHT AND RIGHT ANGLE BULKHEAD JACKS CRIMP TYPE FOR FLEXIBLE CABLE

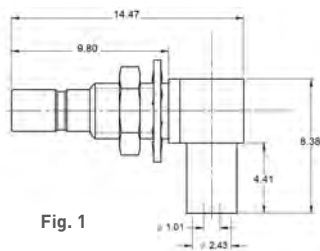
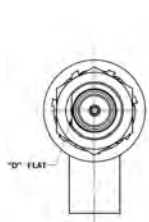

Fig. 1

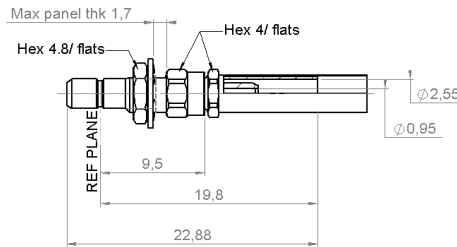
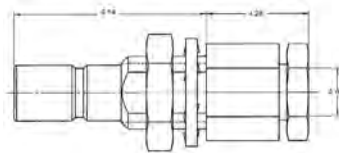

Fig. 2

Cable group	Cable group dia.	Part number	Fig.	Captive center contact	Panel drilling	Finish	Note
RG178 / RG196	2/50S	7406-1521-002	1	yes	P01	Gold	Right angle Rear mount
RG174 / RG316	2.6/50S	7406-1521-003					
RD178	2/50D	7406-1521-005					
RG178 / RG196	2/50/S	R203 313 000	2				Straight rear mount

STRAIGHT BULKHEAD JACK SOLDER TYPE FOR SEMI-RIGID CABLE



Cable group	Cable group dia.	Part number	Dimensions A (mm)	Captive center contact	Panel drilling	Finish
RG405	.085"	7203-1541-010	2.26	yes	P01	Gold
M17 / 151	.045"	7203-1541-011	1.27			

STRAIGHT BULKHEAD RECEPTACLES (male center contact)

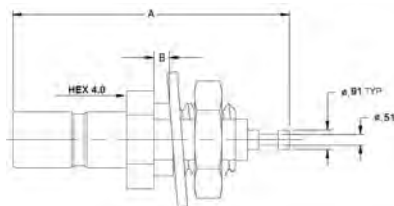

Part Number	Captive center contact	Dimensions (mm)		Panel drilling	Finish	Note
		A	B			
7204-1511-000	yes	13.0	2.0	P01	Gold	Rear mount
7219-1511-000			1.7			Front mount
R203 553 00		13.3	1.7			

Receptacles

RIGHT ANGLE PCB BULKHEAD RECEPTACLES (male center contact)

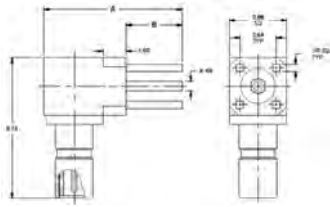

Part number	Captive center contact	Panel drilling	Finish	Dimensions		
				A	B	C
7410-1511-000	yes	P01	Gold	14.5	12.5	9.8
7410-1511-012			Pretinned			
7410-1511-050			Gold			
7410-1511-040			Pretinned			

STRAIGHT PCB RECEPTACLES (male center contact)

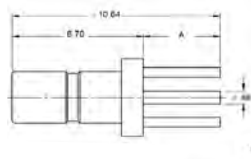

Fig. 1

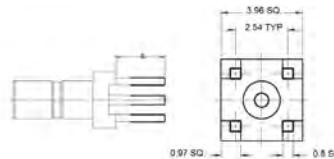

Fig. 2

Part number	Fig.	Captive center contact	Dimensions (mm) A	Panel drilling	Finish	Note
7209-1511-000	1	yes	3.93	P02	Gold	No stand off
7209-1511-012			3.43			Pretinned legs, no stand off
7209-1511-011			0.0			
7209-1511-015	2		3.43	SMT version		
7209-1511-040			3.2	Pretinned legs		
7209-1511-050				□		
R203 426 000			Body 3.5			

STRAIGHT PCB RECEPTACLES (female center contact)

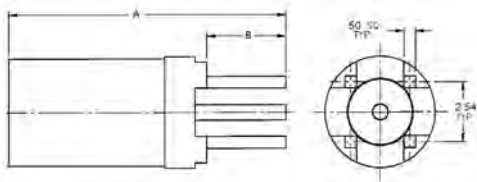

Fig. 1

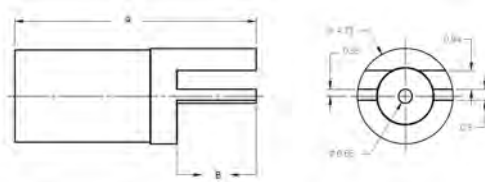

Fig. 2

Part number	Fig.	Captive center contact	Dimensions (mm)		Panel drilling	Finish	Note
			A	B			
7225-1512-000	1	yes	12.0	3.93	P02	Gold	No stand off
7225-1512-012			12.0	3.93			Pretinned legs, no stand off
7225-1512-050			12.0	3.43			
7225-1512-040			12.0	3.43			Pretinned legs
7225-1512-060	2		12.0	3.93			End launch version
7225-1512-004	1		8.7	0.0			

Receptacles

RIGHT ANGLE PCB RECEPTACLES (male center contact)

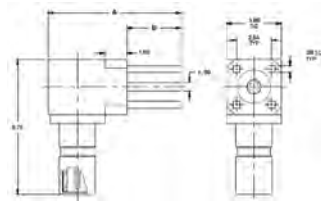
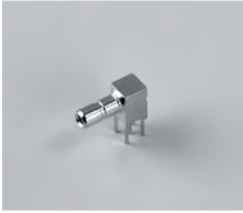

Fig. 1

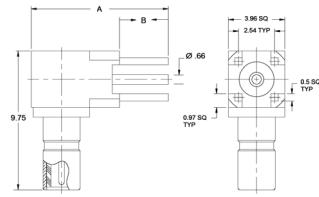
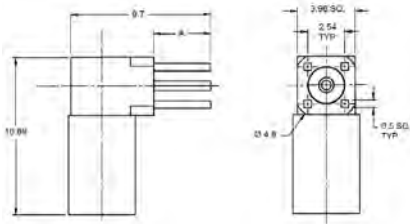

Fig. 2

Part number	Fig.	Captive center contact	Dimensions (mm)		Panel drilling	Finish	Note
			A	B			
7210-1511-000	1	yes	9.65	3.93	P02	Gold	No stand off
7210-1511-012							Pretinned legs, no stand off
7210-1511-015							SMT version, no stand off
7210-1511-019							No standoff
7210-1511-040	2		9.65	3.42	P02		Pretinned legs
7210-1511-050							
R203 665 000			8.9	3.2			

RIGHT ANGLE PCB RECEPTACLES (female center contact)



Part number	Captive center contact	Dimensions (mm)	Panel drilling	Finish	Note
		A			
7242-1511-000	yes	3.93	P02	Gold	
7242-1511-012					Pretinned legs
7242-1511-050		3.43			Stand off legs

IN SERIES ADAPTERS

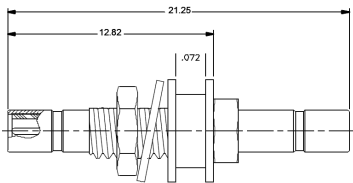

Part number	Captive center contact	Panel drilling	Finish	Note
7222-1501-600	yes	P01	Gold	Bulkhead male - male

Introduction

SSMC connectors are about a third smaller than SMC. They are mainly used in avionics, missiles, and any limited-space applications that require the security of a threaded coupling.

GENERAL

- DC - 12 GHz
- Impedance 50Ω
- Screw-on coupling
- Microminiature connectors
- Very low weight and small size

APPLICATIONS

- Civil avionics
- Military aerospace, missiles

APPLICABLE STANDARDS

- MIL STD 348A
- IEC 60169-20
- MIL-PRF-39012

Characteristics

Test / Characteristics	Values / Remarks
------------------------	------------------

GENERAL

Impedance	50Ω
Frequency range	DC - 12.4 GHz
Temperature range	-65°C to + 165°C

ELECTRICAL CHARACTERISTICS

Insertion loss in dB	0.3Vf (GHz)	
RF leakage	≤ -55 dB at 1 GHz	
VSWR max up to 4GHz	RG 178 cable: 1.20 + 0.02F (GHz)	
Contact resistance (inner contact)	Center contact: 5mΩ max. Outer contact: 1mΩ max.	
Insulation resistance	1000MΩ	
Voltage in VRMS <ul style="list-style-type: none"> • At sea level • At 70,000 ft 	Dielectric withstanding voltage <ul style="list-style-type: none"> ≥ 500V 100V 	Working voltage <ul style="list-style-type: none"> ≤ 250V 60V

MECHANICAL CHARACTERISTICS

Cable retention force	RG174: 50N - RG316: 100N
Mating endurance	500
Center contact retention force	≥ 8N

ENVIRONMENTAL CHARACTERISTICS

Vibration	MIL-STD-202, Method 204, Condition D (20g)
Shock	MIL-STD-202, Method 213, Condition B, 75g-6ms 1/2 sinus
Corrosion (salt mist)	MIL-STD-202, Method 101, Condition B (48h)

MATERIALS AND PLATING

	Material	Plating
Body	Brass	Gold
Contacts	Beryllium copper	Gold
Insulators	PTFE	

Plugs

STRAIGHT PLUGS FOR FLEXIBLE AND SEMI-RIGID CABLES

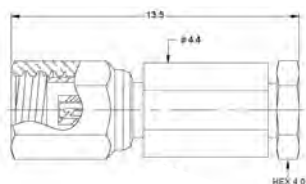

Fig. 1

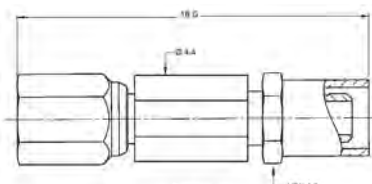
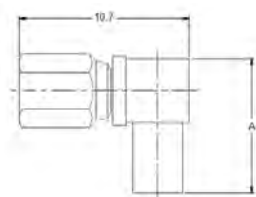

Fig. 2

Cable group	Part number	Fig.	Note	Finish
RG405	7002-1542-010	1	Solder type	Gold
M17 / 151	7002-1542-011			
RG178 / RG196	7002-1572-002	2	Crimp type	
RG174 / RG316	7002-1572-003			
RD316	7002-1572-019			
RG178 / RG196	7002-1571-002			
RG178 / RG196	7002-1571-003			
RD316	7002-1571-019			

RIGHT ANGLE PLUGS FOR FLEXIBLE AND SEMI-RIGID CABLES



Cable group	Cable group dia.	Part number	Dimensions (mm) A	Note
RG178 / RG196	2/50S	7105-1521-002	8.4	Crimp type
RG174 / RG316	2.6/50S	7105-1521-003		
RD316	2/50D	7105-1521-019		
RG405	.085"	7105-1561-010	8.2	Solder type
M17 / 151	.047"	7105-1561-011		

STRAIGHT JACKS FOR FLEXIBLE AND SEMI-RIGID CABLES

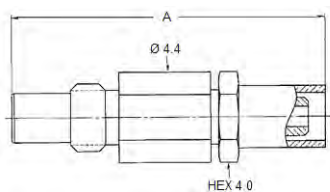

Cable group	Cable group dia.	Part number	Dimensions (mm) A	Note
RG178 / RG196	2/50S	7101-1571-002	16.0	Crimp type
RG405	.085"	7101-1541-010	8.8	Solder type

Jacks, receptacles and adapters

BULKHEAD STRAIGHT AND RIGHT ANGLE JACKS FOR FLEXIBLE AND SEMI-RIGID CABLES

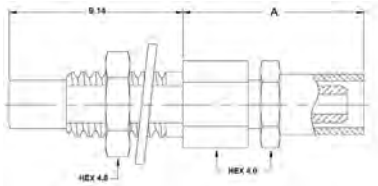

Cable group	Cable group dia.	Part number	Dimensions A(mm)	Panel drilling	Finish	Note
RG178 / RG196	2/50S	7003-1572-002	9.7	P01	Gold	Crimp type
RG174 / RG316	2.6/50S	7003-1572-003	9.7			Solder type
M17 / 151	.047"	7003-1542-011	4.8			

PCB RECEPTACLES

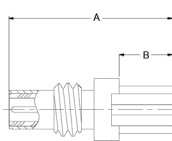

Fig. 1

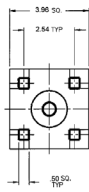

Fig. 2

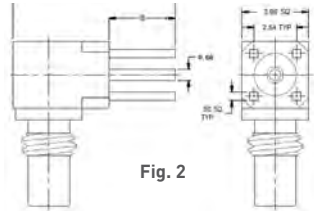
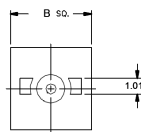
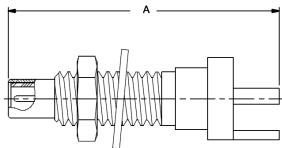

Fig. 3

Part number	Fig.	Dimensions (mm)		Panel drilling	Finish	Note
		A	B			
7009-1511-000	1	10.6	4.0	P02	Gold	No stand off
7009-1511-050		10.6	3.42			Stand off legs
7009-1511-004		7.34	0			Stand off legs, SMT version
7010-1511-000	2	9.65	4.0	P02	Gold, pre-tinned legs	No stand off
7010-1511-041			3.42			Stand off legs
7010-1511-050	3	9.65	3.42	P02	Gold, pre-tinned legs	Male center contact
7042-1511-040	2	9.65	4.0	P02	Gold	No stand off, bulkhead
7110-1511-000			3.42			Stand off legs, bulkhead

END LAUNCH BULKHEAD RECEPTACLES



Part number	Dimensions (mm)		Finish
	A	B	
7029-1511-031	17.52	5.25	Gold
7029-1513-005	14.85	6.35	
7029-1513-004	14.85	3.96	

IN SERIES ADAPTERS

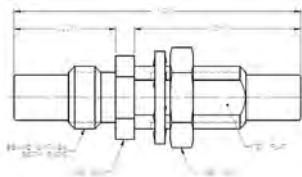

Part number	Captive center contact	Panel drilling	Finish	Note
7122-1502-000	yes	P01	Gold	Bulkhead male-male

Panel drilling

PANEL DRILLING SSMB/SSMC

P01

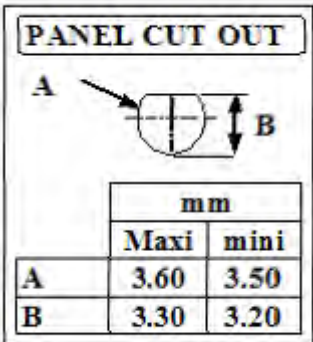

P02

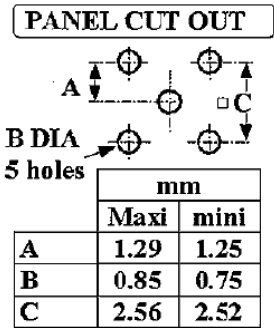

SSMB / SSMC

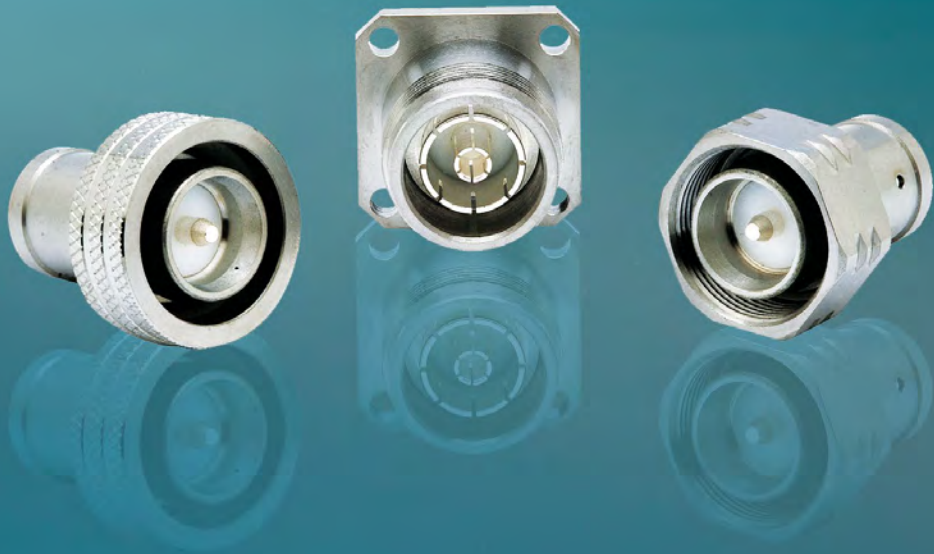

4.1-9.5 / 4.3-10 / QLI / 7-16

R170 / R183 / R184 / R185



Contents

7/16

Introduction..... 13-4 to 13-5
Interface 13-6
Characteristics 13-7 to 13-8
Plugs 13-9
Jacks 13-10 to 13-11
Receptacles..... 13-11
Adapters 13-12
Caps..... 13-12

COMPOSITE 7/16

Introduction..... 13-4 to 13-5
Interface 13-6
Characteristics 13-8
Jacks 13-13
Receptacles..... 13-13
Panel drilling 13-14

QLI

Introduction..... 13-15
Characteristics 13-16
Plugs 13-17
Jacks 13-17 to 13-18
Protective Cap 13-18

4.3-10

Introduction..... 13-19
Characteristics 13-20
Plugs 13-21 to 13-22
Jacks 13-22
Panel drilling 13-22

4.1-9.5

Introduction..... 13-23
Characteristics 13-24
Plugs 13-25
Jacks 13-25

Introduction



50Ω

DC - 7.5 GHz

GENERAL

- Standard coaxial connectors
- Screw-on coupling
- High power rating
- Excellent RF performance

APPLICABLE STANDARDS

- IEC 169-4
- DIN 47223
- CECC 22 190

APPLICATIONS

- Mobile communication infrastructure networks: combiner, diplexer, filter...
- Jumper and feeder cables assemblies
- Radio links
- Indoor and outdoor applications

Radiall's 7/16 series has been developed using the latest technology advances in connector design. These connectors are easy to use, highly reliable, innovative and are designed to meet the needs of the telecommunications market. The complete connector series feature the following characteristics:

- An extensive range, with optimized component part design
- An upgraded cross-knurled coupling nut allowing better manual tightening

Composite 7/16

Radiall expanded its line of innovative 7/16 composite connectors with jacks and receptacles as a lightweight, low cost alternative to brass connectors. Manufactured with corrosion-proof, composite materials these new single-piece connectors are UV resistant, meeting IEC 68-2-5 and IEC-68-2-9 to withstand all environments, including harsh outdoor installations. Radiall now offers over 20 different variations. The selection of the composite materials is a result of an in-depth competitive analysis of creeping speeds of zinc and aluminum alloys. Not only do the composite materials offer considerable performance advantages guaranteeing up to 500 matings; but with more than a 50% reduction in weight, this receptacle reduces the overall weight of the final module as well as transportation costs.

Introduction

High performance range

- Frequency range: DC - 7.5 GHz
- 2 types of coupling nut:
 - cross-knurled and 6 flats 27 mm wide coupling nut (3 000 N.cm)
 - 6 flats coupling nut (32 mm wide), allowing high coupling torque (3 500 N.cm) when used with a torque wrench
- Intermodulation performance: 2 levels
 - 125 dBm cable assemblies
 - 110 dBm connectors and cable assemblies



2 types of coupling nut

Radiall has developed its intermodulation measurement equipment following the IEC 46 D/292/NP standard proposal. It is aimed at third-order IMP measurements through the reflection method. The range of this test set-up is -132 dBm (-175 dBc) under 2 x 20 W.

- High performance non-magnetic material (brass) and plating (silver) with anti-tarnishing finish (strike of BBR)
- Non-slotted outer contact on standard products
- The 7/16 connector series benefits from a complete easy-to-use range of tooling



Custom models

To fulfill customer requirements, Radiall offers complete design of custom connectors according to the 7/16 series standard.

What is INTERMODULATION?

Intermodulation (IM) is an undesired modulation that leads to a distortion of the output high-frequency carrier. It is defined as the ratio of the 3rd order intermodulation products and the incident signal power because the most troublesome IM products are those of 3rd order.

For more detailed information, including our intermodulation measurement system and our product range, please visit www.radiall.com

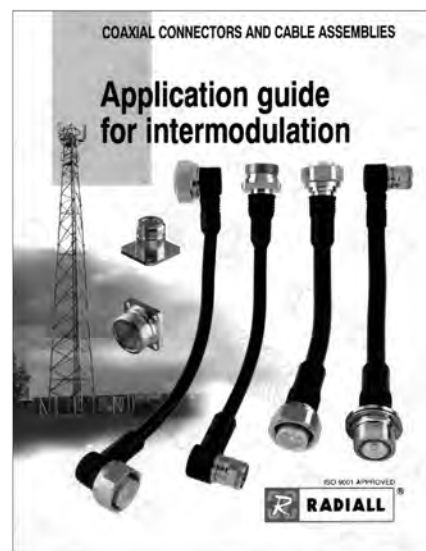

7/16/COMPOSITE 7/16

Interface

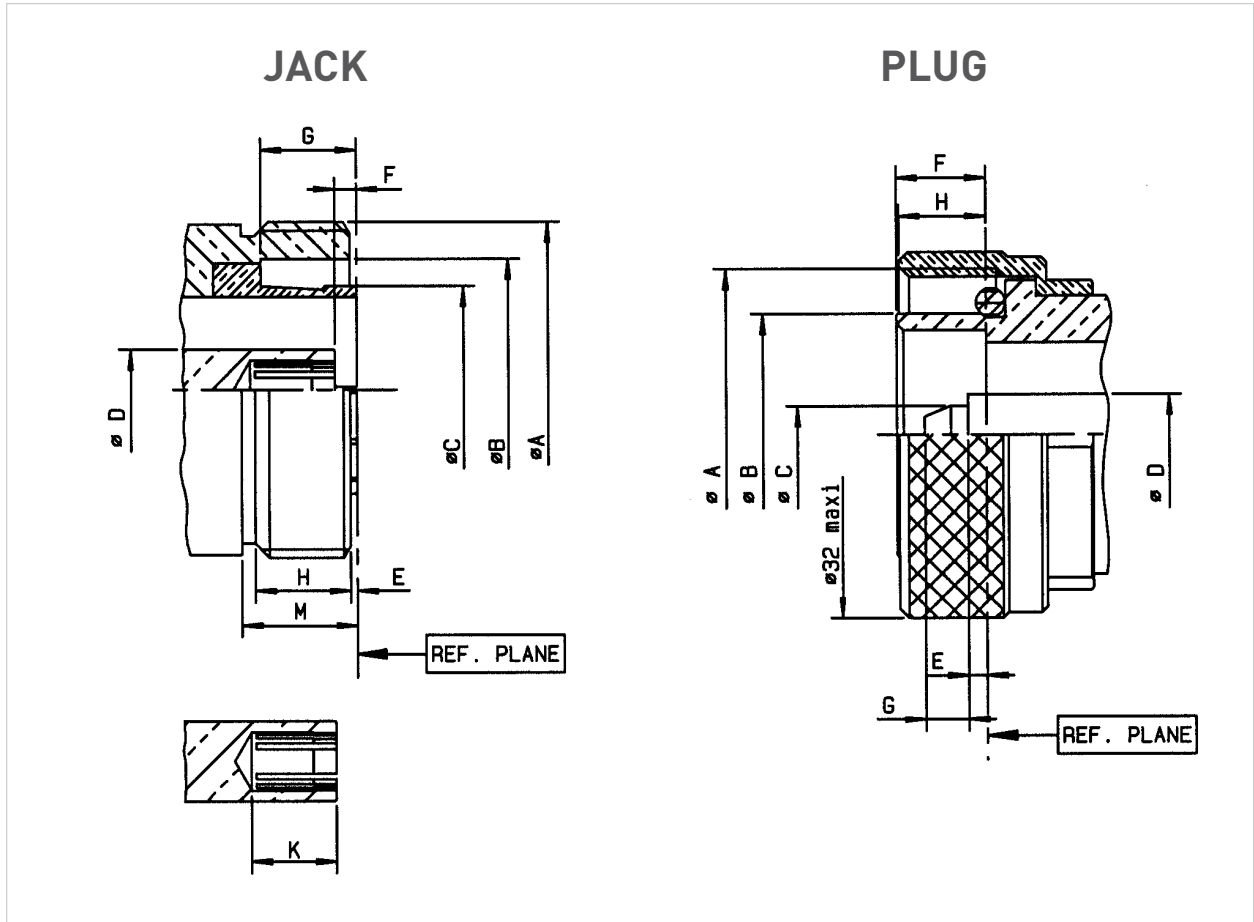

Letter	mm		inch	
	min.	max.	min.	max.
A DIA	M29 X 1.5		M29 X 1.5	
B DIA	22.5	22.7	.885	.893
C DIA	17.9	17.96	.704	.707
D DIA	6.95	7.00	.273	.275
E	0.50	0.70	.019	.027
F	1.77	2.07	.069	.081
G	8.20	8.40	.322	.330
H	8.25	8.75	.324	.344
K	7.25	7.55	.285	.297

Letter	mm		inch	
	min.	max.	min.	max.
A DIA	M29 X 1.5		M29 X 1.5	
B DIA	20.8	21.0	.818	.826
C DIA	4.97	5.03	.195	.198
D DIA	6.95	7.00	.273	.275
E	1.47	1.77	.057	.069
F	7.40	7.80	.291	.307
G	3.60	4.00	.141	.157
H	7.30	7.80	.287	.307

Characteristics

Test / Characteristics	Standard reference	Values / Remarks
------------------------	--------------------	------------------

ELECTRICAL CHARACTERISTICS

Impedance		50Ω
Frequency range		DC - 7.5 GHz
Typical V.S.W.R.		1 GHz 2.5 GHz 5 GHz 7.5 GHz
• Straight models		1.10 max from DC to 3 GHz - 1.20 max from 3 to 7.5 GHz
RG213-RG214-RG393		
.141"	1.04	1.06 1.08 1.10
.250"	1.04	1.07 1.08 1.20
1/2" superflexible corrugated	1.03	1.05 1.11 1.13
3/8" superflexible corrugated	1.02	1.04 1.05 1.05
1/4" superflexible corrugated	1.03	1.03 1.12 1.20
	1.01	1.02 1.09 1.17
• Right angle models		1.15 max from DC to 3 GHz
RG213-RG214-RG393		
1/2" superflexible corrugated	1.02	1.04 1.12 1.50
3/8" superflexible corrugated	1.04	1.04 1.14 1.60
1/4" superflexible corrugated	1.05	1.08 1.12 1.80
	1.02	1.06 1.13 1.60
Intermodulation product (IMP ₃)		
• Connectors		-110 dBm typ. [- 153 dBc typ / 20 W]
• Home made cable assemblies		-125 dBm typ. [- 168 dBc typ. / 20 W]
Insertion loss (dB)		
Straight connectors and right-angle connectors	MIL	0.05 vF (GHz)
RF Leakage	CECC	130 dB at 1 GHz
Insulation resistance	CECC	10 000 MΩ min
Contact resistance		
• Center contact	CECC	< 0.4 mΩ
• Outer contact		≤ 1.5 mΩ
Working voltage in VRMS at sea level	CECC	2 700
Dielectric withstanding voltage in VRMS		
• At sea level	CECC	4 000
(at 70, 000 feet)		350

MECHANICAL CHARACTERISTICS

Durability	CECC	500 matings
Force to engage and disengage	CECC	15 N
Recommended coupling nut torque		
• Hex. coupling nut		3 500 Ncm (with torque wrench R 282 303 500)
• Hex. + cross knurl coupling nut		3 000 Ncm (with torque wrench R 282 303 520)
Proof torque	CECC	3 500 Ncm
Coupling nut retention force	CECC	1 000 N
Cable retention force		
Cable 5/50 & 10/50		250 N
Cable 1/4"	CECC	200 N
Cable 3/8"		250 N
Cable 1/2"		350 N
Cable 7/8"		500 N
Center contact retention force	CECC	200 N

ENVIRONMENTAL CHARACTERISTICS

Temperature range		
• Flexible cables and corrugated cables	CECC	- 55 °C + 155 °C
• Semi-rigid cables		- 55 °C + 105 °C
Thermo cycling test	CECC	- 55 °C / + 155 °C / 56 days
Rapid change of temperature	IEC	- 55 °C / + 155 °C / 5 cycles
High temperature test	CECC	1000 hours / 155 °C
Corrosion salt spray	IEC	48 hours / Na Cl 5% / 35 °C
Vibration	CECC	98 m/s ² - 10 Hz at 500 Hz
Moisture resistance		
• Clamp type	IEC 529	IP67
• Crimp type		IP65 (with heatshrink sleeve)
• Home made cable assemblies		IP68 (overmolding)
Hermetic test	IEC	5 Pa. cm ³ /s
Leakage	CECC	1 cm ³ /h max

Characteristics 7/16

MATERIALS AND PLATINGS

	Materials	Plating
Bodies	Brass	Silver + BBR
Nut	Brass	BBR
Center contact • Male • Female	Brass Beryllium copper	Silver
Insulator	PTFE	
Gasket	Silicon rubber	

POWER RANGE

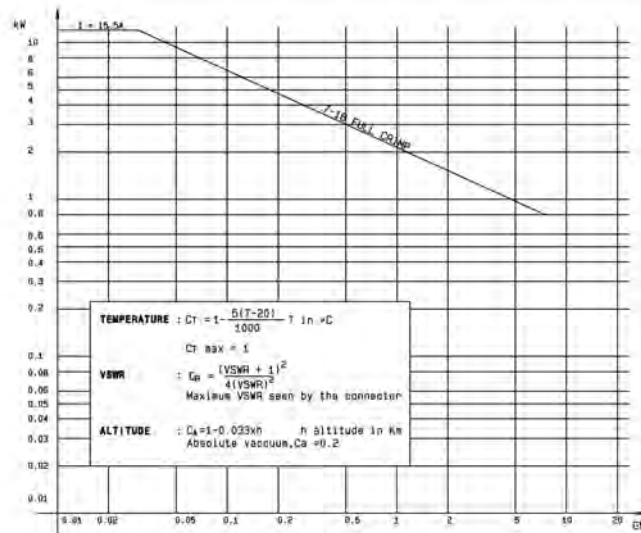

Characteristics composite 7/16

ELECTRICAL CHARACTERISTICS

Frequency range	DC - 7.5 GHz
VSWR	1.06@DC-3 GHz - 1.10@DC - 3-7.5 GHz
High working voltage	> 2700 V
Very low intermodulation	IMP3 < -125 dBm under 2 carriers of +43dBm And typically < -130 dBm
Power handling	> 800 W@ 935 MHz

MECHANICAL CHARACTERISTICS

Longlife duration	up to 500 mating cycles
Coupling torque	35 Nm or less
Coupling strength	1000 N
Center contact retention / axial force	> 200 N
Center contact retention / torque	> 80 Ncm

ENVIRONMENTAL CHARACTERISTICS

Temperature range	-40°C / +85°C
Humidity	Up to 100% @ 20°C
Flammability rating	UL94-V0
UV resistance	IEC 68-2-5 / IEC 68-2-9
Waterproof	IP67

Straight jacks and square flange jacks

STRAIGHT JACKS

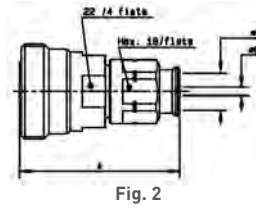
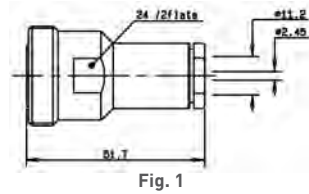

Cable group	Cable group dia.	Part number	Fig.	Dimensions (mm)			Captive center contact	Finish	Note
				A	B	C			
RG393 / RG214	10 + 11/50 D	R185 210 000	1				yes	Silver + BBR	Clamp type
	1/4" superflexible corrugated	R185 215 200	2	49.45	7.95	4.7			
	1/2" superflexible corrugated	R185 216 200		50	14	8.8			
	3/8" superflexible corrugated	R185 217 200			11	7.1			

STRAIGHT SQUARE FLANGE JACKS

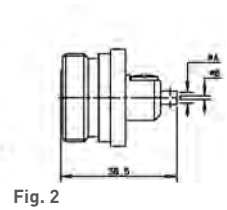
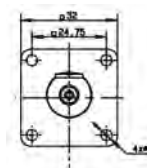
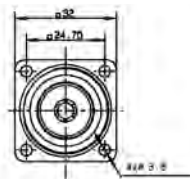
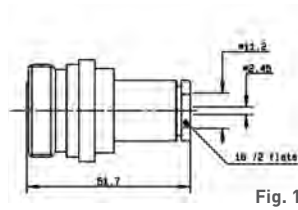

Cable group	Cable group dia.	Part number	Fig.	Captive center contact	Dimensions (mm)			Panel drilling	Finish	Note
					A	B	C			
RG393 / RG214	10 + 11/50 D	R185 260 000	1	yes				P01	Silver + BBR	Clamp type for flexible cables
RG402	.141"	R185 252 000	2		3.65	0.996	3.6	P01		Solder type for semi-rigid cables

Bulkhead jacks and receptacles

STRAIGHT BULKHEAD JACKS FOR FLEXIBLE CABLES AND CORRUGATED CABLES

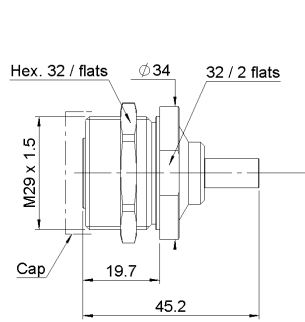

Fig. 1

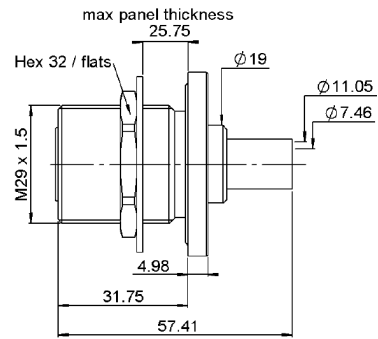

Fig. 2

Cable group	Cable group dia.	Part number	Fig.	Dimensions (mm)					Captive center contact	Panel drilling	Finish	Note
				A	B	C	D	E				
AEP-240FR	LMR® 240	R185 314 100	1	19.7	45.2	1.5	4.05	6.6				
AEP-400FR	LMR® 400	R185 320 020	2	31.75	57.41	7.46	11.05	25.75	yes	P02	BBR	Clamp type

STRAIGHT FLANGE FEMALE RECEPTACLES

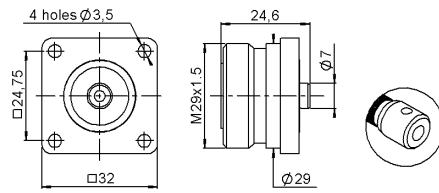
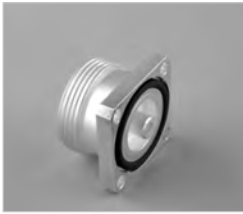

Fig. 1

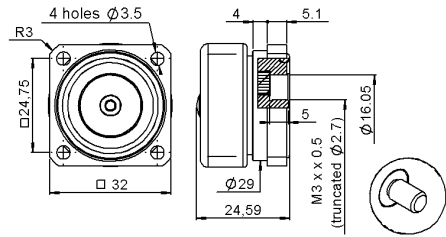

Fig. 2

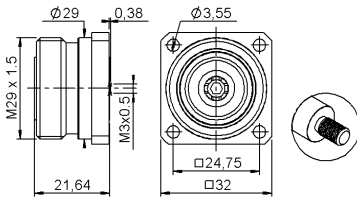

Fig. 3

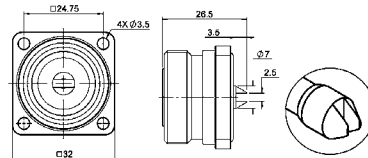

Fig. 4

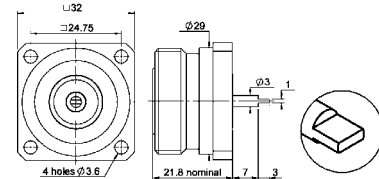

Fig. 5

Part number	Fig.	Captive center contact	Panel drilling	Finish	Slotted outer contact	Packaging	Note
R185 403 547	1	yes	P03	BBR	no	20	With solder pot contact
R185 405 200	2		P05	Silver + Copper	yes	50	Panel seal flange mount
R185 406 090	3			BBR			M3
R185 404 200	4		P05	Silver + Copper	no	20	With slotted contact
R185 403 490	5		P04			20	With tab contact

In series adapters and caps

IN SERIES ADAPTERS

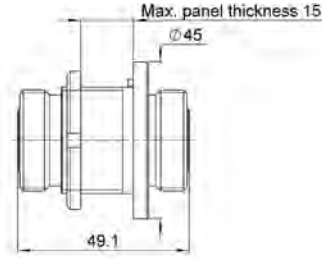
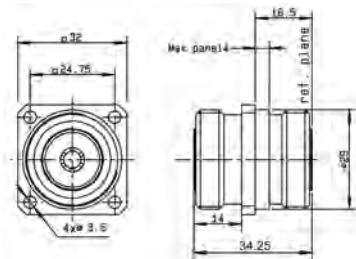
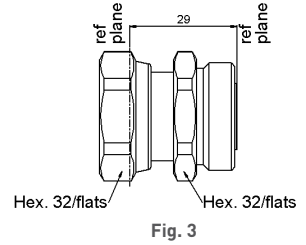
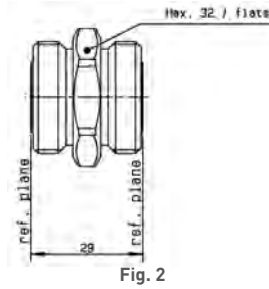
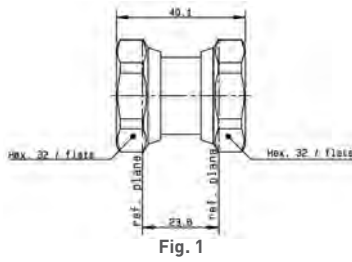
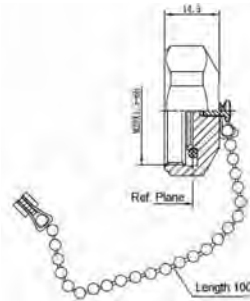

Fig. 4

Fig. 5

Part number	Fig.	Captive center contact	Panel drilling	Finish	Note
R185 703 000	1	yes		Silver + Copper	male - male
R185 705 000	2				female - female
R185 707 000	3				male - female
R185 710 000	4		P01	female - female flange mount	
R185 730 020	5		P06	Silver + BBR	female - female

PROTECTIVE CAPS



Part Number	Note
R185 812 007	male with chain

Square flange jacks

SQUARE FLANGE JACK RECEPTACLE SOLDER TYPE, PANEL SEAL

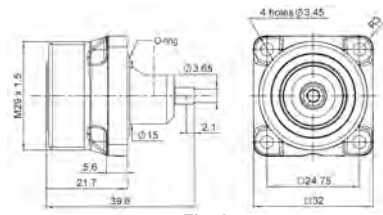

Fig. 1

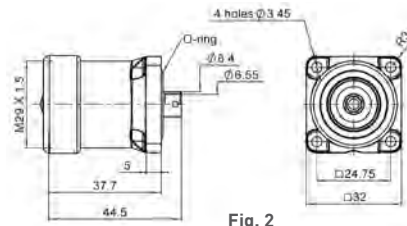

Fig. 2

Cable group	Cable group dia.	Part number	Fig.	Panel drilling
RG402	.141"	R187 403 010	1	P07
RG401	.250"	R187 130 000	2	

SQUARE FLANGE JACK RECEPTACLE PANEL SEAL

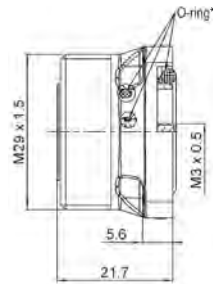

Fig. 1

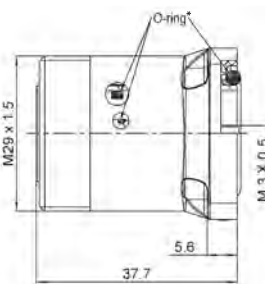

Fig. 2

Part number	Fig.	Captive center contact	Waterproof interface	Color	Panel drilling
R187 403 000	1	no	no	Black	P07
R187 403 100		no	yes		
R187 406 000		yes	no		
R187 406 100	2	yes	yes		
R187 413 000		no	no		
R187 413 100		yes	yes		
R187 416 000		no	no		
R187 416 100		yes	yes		

Available packaged in increments of 20 units

Processed according to customer needs

* O-ring inside, only on the waterproof models

7/16/COMPOSITE 7/16

Panel drilling

P01

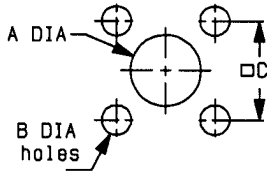

	MM		INCH	
	maxi	mini	maxi	mini
A	29.2	29.1	1.15	1.146
B	3.7	3.6	0.146	0.142
C	24.8	24.7	0.976	0.972

P02

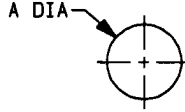

A	MM		INCH	
	maxi	mini	maxi	mini
	29.2	29.1	1.15	1.146

P03

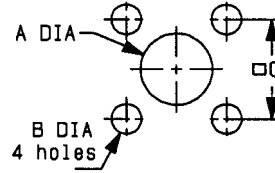

	MM		INCH	
	maxi	mini	maxi	mini
A (R. Mount)	16.2	16	0.638	0.63
A (F. Mount)	29.3	29.1	1.154	1.146
B	3.7	3.6	0.146	0.142
C	24.8	24.7	0.976	0.972

P04

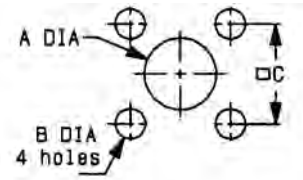

	MM		INCH	
	maxi	mini	maxi	mini
A	12.3	12.1	0.484	0.476
B	3.8	3.7	0.15	0.146
C	24.8	24.7	0.976	0.972

P05

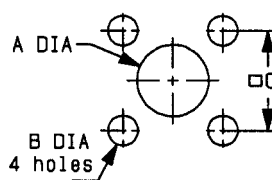

A	MM		INCH	
	maxi	mini	maxi	mini
	16.2	16	0.638	0.63
B	3.7	3.6	0.146	0.142
C	24.8	24.7	0.976	0.972

P06

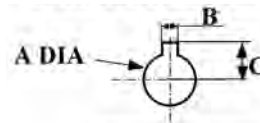

	mm	
	Maxi	mini
A	30.55	30.45
B	3.3	3.2
C	17.6	17.5

P07



	mm	
	Maxi	mini
A	16.2	16
B	3.7	3.6
C	24.8	24.7

Introduction

50Ω	DC - 6 GHz
-----	------------



Overview

Radiall has expanded its broad range of Quick Lock products with QLI (Quick Lock Low Intermodulation). With the QLI, Radiall introduces a new solution for harsh environments, where performance and safety are critical. QLI connectors are designed to provide performance similar to DIN 7/16 with a very low intermodulation level, and a quick and safe connection, without any tools. Compared to 7/16, QLI is cheaper but also smaller (-31%) and lighter (-62%) offering an easy to use concept with its bayonet coupling system.

Its double sealing, in addition to a special anti-corrosion & watertight plating, makes this connector the best choice for outdoor installations and also indoor applications where the best performance is required. QLI connectors are available in plugs, jacks, straight or right angle, square sockets & bulkhead models with a compact design allowing high density integration (saving time on field installation).

Its simple jack design makes QLI robust and easy to clean when equipments are subjected to severe conditions in the field.

HIGH PERFORMANCE

- Impedance 50Ω
- Frequency range DC - 6 GHz
- Very low intermodulation level $\leq -163\text{dBc}$
- Bayonet locking concept provides coupling retention force 450 N
- VSWR $1.04 + 0.02 \text{ V}$
- Meets all requirements for IP67

GENERAL

- Quick Lock Low Intermodulation connector
- Bayonet coupling mechanism
- High power rating
- 31% smaller & 60% lighter than 7/16

APPLICABLE STANDARDS

- IEC 61169
- MIL PRF 39012

APPLICATIONS

- Telecom
- Medical
- Industrial
- Indoor and outdoor use

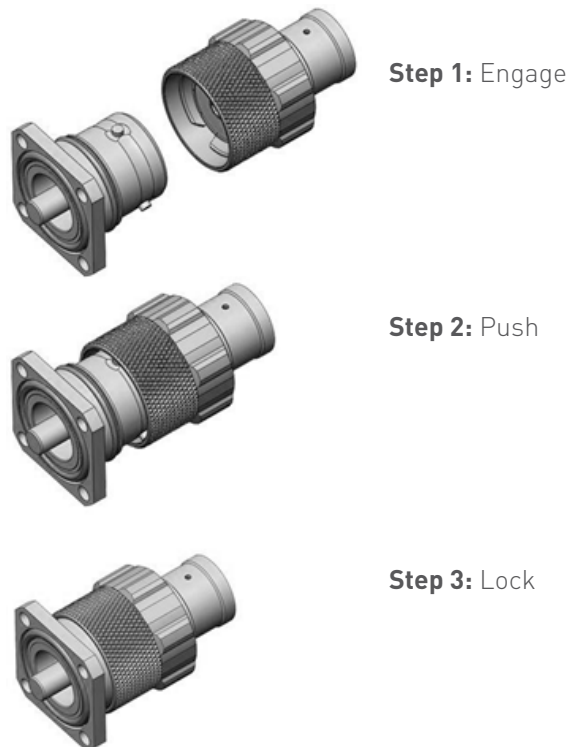

- High mating life
- 3 step connection: Engage, Push & Lock
- Intuitive design concept
- Light weight
- Reduced size allows more space for other components
- RF Power: Up to 1000 W @ 2 GHz

Characteristics

Test / Characteristics	Values / Remarks
------------------------	------------------

ELECTRICAL CHARACTERISTICS

Impedance	50Ω
Frequency range	DC - 6 GHz
Typical VSWR	1.04 + 0.02 f (GHz)
Maximum insertion loss	0.05 √F (GHz) dB
Insulation resistance	5000 MΩ min
Voltage rating	<=1400 Veff
Dielectric withstanding voltage	>2500 Veff
Contact resistance	≤ 1 mΩ ≤ 1.5 mΩ
• Center contact	
• Outer contact	
Power	1000W @ 2 GHz
Intermodulation	>163dBc (>120 dBm) 2x20W
Typical RF Leakage	-100dB@1 GHz; -90dB@3 GHz; -80dB@5 GHz

MECHANICAL CHARACTERISTICS

Mechanical endurance	100 cycles
Engagement & disengagement force	<= 60N <= 50 N
• Engagement	
• Disengagement	
Mating mechanical retention force	450 N min.
Cable retention force	350 N mini with 1/2" S cable
Vibration	IEC 611169-1 10g / 10-500 Hz

ENVIRONMENTAL CHARACTERISTICS

Temperature range	- 55 °C ~ + 120 °C
Moisture resistance	IP67

MATERIALS

Connector bodies	Brass
Male center contact	Bronze / Brass
Female center contact	Bronze
Outer contact	Brass
Other metallic parts	Brass
Insulators	PTFE

PLATING

Bodies	BBR
Outer contact	BBR
Center contact	Silver

Plugs and jacks

STRAIGHT PLUGS

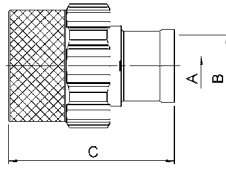

Fig. 1

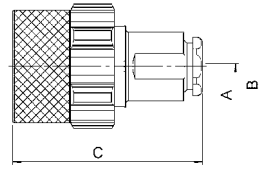
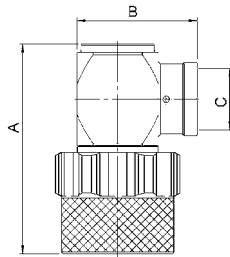

Fig. 2

Cable group	Cable group dia.	Part number	Fig.	Dimensions			Captive center contact	Finish	Packaging	Note
				A	B	C				
	1/2" Superflexible corrugated	R184 061 007	1	3.8	12.55	29	yes	Silver + BBR	50	Solder
	1/4" Superflexible corrugated	R184 062 007		2	6.8	28.5				
RG58 / RG141 / KX15	5/50S	R184 082 007		1.05	5.41	40.15				
LMR®400 / LMR400® FR / AEP-400FR	10.3/50S	R184 086 007		2.82	11.05	39				
AEP-600F / LMR®600	15/50S	R184 087 007		4.7	15.88	42				
RG58 / RG141 / RG223 / RG400	5/50S+D	R184 006 007	2	1.05	5.6	38.5				Clamp
RG213 / RG214 / RG393	10+11/50S+D	R184 018 007		2.45	11.2	46.5				
	1/2" Superflexible corrugated	R184 037 007		N/A	14	49.7				

RIGHT ANGLE PLUGS



Cable group dia.	Part number	Dimensions			Captive center contact	Finish	Packaging	Note
		A	B	C				
1/2" Superflexible corrugated	R184 191 007	42.7	24.40	12.55	yes	Silver + BBR	50	Solder

STRAIGHT JACK

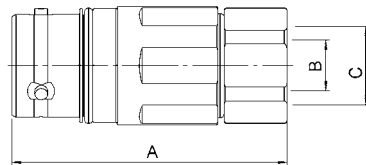

Cable group dia.	Part number	Dimensions			Captive center contact	Finish	Packaging	Note
		A	B	C				
1/2" Superflexible corrugated	R184 216 007	49.1	9.00	14.00	yes	Silver + BBR	50	Clamp

Jacks and cap

BULKHEAD STRAIGHT JACK

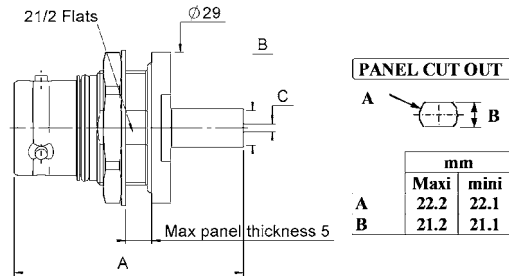

Cable group	Cable group dia.	Part number	Dimensions			Captive center contact	Finish	Packaging	Note
			A	B	C				
LMR®240 / AEP-240FR	6.1/50S	R184 335 007	44.2	6.60	1.50	yes	Silver + BBR	50	Crimp
RG213 / RG214 / RG393	10+11/50S+D	R184 339 007	43.6	11.20	2.45				Clamp

SQUARE FLANGE STRAIGHT JACK

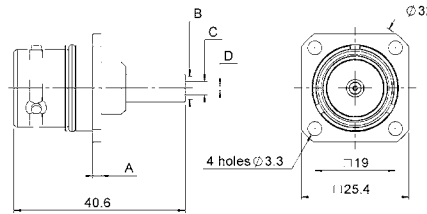

Fig. 1

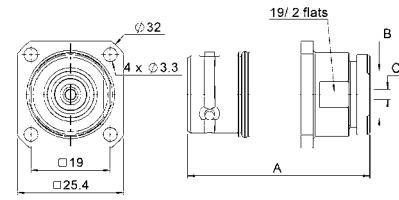

Fig. 2

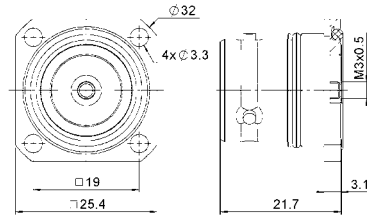
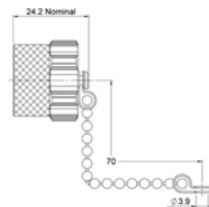

Fig. 3

Cable group	Cable group dia.	Part number	Fig	Dimensions				Captive center contact	Finish	Packaging	Note
				A	B	C	D				
RG58 / KX15 / RG141	5/50S	R184 282 007	1	41	5.41	3.11	1.05	yes	Silver + BBR	50	Crimp
RG393 / RG214 / RG213	10+11/50S+D	R184 339 007	2	43.6	11.20	2.45	Clamp				
	M3	R184 405 007	3	-	-	-					

PROTECTIVE CAP



Part number	Note
R184 960 007	Metallic male with chain - IP67

Introduction



50Ω

DC - 6 GHz

GENERAL

- Low Intermodulation connector
- Screw-on & Push-pull coupling mechanism
- High power rating
- 30% smaller & 60% lighter than 7/16

APPLICABLE STANDARDS

- IEC 61169
- MIL PRF 39012

APPLICATIONS

- Telecom
- Medical
- Industrial
- Indoor and outdoor use

Overview

Designed for major telecom equipment manufacturers, the 4.3-10 series offers a small, lightweight solution for outdoor telecom applications where high performance is essential and low intermodulation is required.

Offering a broad product portfolio consisting of the Radiall 4.3-10, 4.1-9.5, 7/16 and the innovative QLI (Quick Lock Low Intermodulation) connector, this solution is suitable for harsh environments where reliability is required.

Available in a variety of configurations including:

- Jack/Bulkhead
- Square flange receptacles and plugs
- Right angle models
- Solder, crimp and clamp models
- Screw-on and push-pull coupling mechanism

The lightweight 4.3-10 connectors are 30% smaller and 60% lighter than comparable 7/16 square flange jack receptacles. The new interface features a high intermodulation level ranging from 0-6 GHz and provides a low intermodulation level at <-166dBc.

Radiall's 4.3-10 connector solution is designed in accordance with international standards and manufactured to meet environmental safety requirements.

HIGH PERFORMANCE

- Impedance 50Ω
- Frequency range DC ~ 6 GHz
- Very low intermodulation level $\leq -166\text{dBc}$
- Screw-on and Push-pull coupling mechanism for safety and easy to use
- VSWR 1.04 + 0.01 V_f
- Meets all requirements for IP67
- High mating life
- 3 step connection: Engage, Push & Lock
- Intuitive design concept
- Light weight
- Reduced size allows more space for other components
- RF Power: Up to 500 W @ 2 GHz

Characteristics

Test / Characteristics	Values / Remarks
ELECTRICAL CHARACTERISTICS	
Impedance	50Ω
Frequency range	DC - 6 GHz
Typical VSWR	1.04 + 0.01 f [GHz]
Maximum insertion loss	0.05 √F [GHz] dB
Insulation resistance	5000 MΩ min
Voltage rating	≤1000 Veff
Dielectric withstanding voltage	≥2500 Veff
Contact resistance	≤ 1 mΩ ≤ 1.5 mΩ
• Center contact • Outer contact	
Power	500W @ 2 GHz
Intermodulation	≤165dBc (>120 dBm) 2x20W
Typical RF Leakage	-110dB@3 GHz; -100dB@3-6 GHz

MECHANICAL CHARACTERISTICS

Mechanical endurance	100 cycles	
Mating force (push-pull version)	≤100 N ≤80 N	IEC 61169-1 §9.3.6
• Engagement force for mating • Separation force for mating		
Mating torque (tool screw type)	5 N. m	IEC 61169-1 §9.3.6
• Torque		
Mating mechanical retention force	450 N min.	
Cable retention force	350 N mini with 1/2" S cable	
Vibration	10g 2 Hz to 200 Hz	IEC 61169-1 § 9.3.3

ENVIRONMENTAL CHARACTERISTICS

Temperature range	- 55 °C ~ + 90 °C
Moisture resistance	IP67

MATERIALS

Connector bodies	Brass
Male center contact	Bronze / Brass
Female center contact	Bronze
Outer contact	Brass
Other metallic parts	Brass
Insulators	PTFE

PLATING

Bodies	BBR
Outer contact	BBR
Center contact	Silver

Plugs

STRAIGHT PLUGS FOR FLEXIBLE AND SEMI-RIGID CABLES

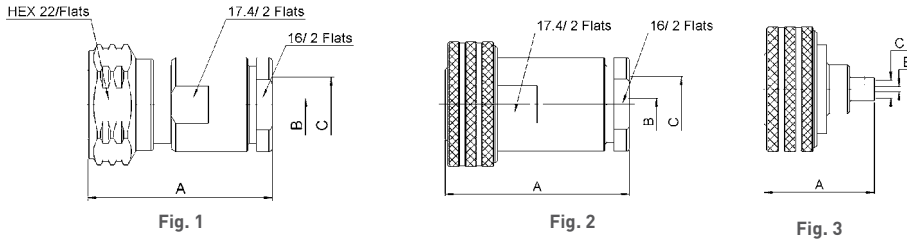

Cable group	Cable group dia.	Part number	Fig.	Dimensions			Captive center contact	Finish	Coupling mechanism	Note
				A	B	C				
RG213 / RG393 / RG214	10+11/50S+D	R183 010 017	1	37.5	2.45	11.20	yes	Silver + BBR	Screw-on	Clamp
		R183 010 007	2						Push-pull	
RG402 / KS2	.141"	R183 052 007	3	21.9	0.96	3.7			Push-pull	Solder

STRAIGHT PLUGS FOR CORRUGATED CABLES

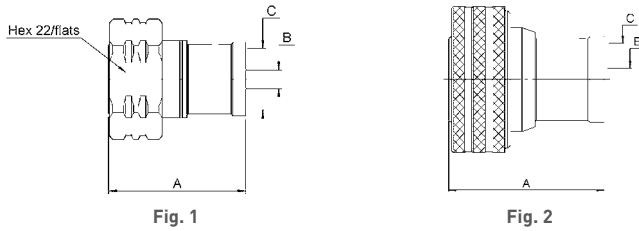

Cable group dia.	Part number	Fig.	Dimensions			Captive center contact	Finish	Coupling mechanism	Note
			A	B	C				
1/2" superflexible corrugated	R183 031 007	1	27.9	3.80	12.55	yes	Silver + BBR	Screw-on	Solder
1/2" superflexible corrugated	R183 031 017	2						Push-pull	
1/4" superflexible corrugated	R183 030 017	1	23.8	2	6.8			Screw-on	
1/4" superflexible corrugated	R183 030 007	2						Push-pull	
3/8" superflexible corrugated	R183 032 007	1	25.9	2.8	9.45			Screw-on	

RIGHT ANGLE PLUGS FOR HANDFORMABLE AND SEMI-RIGID CABLES

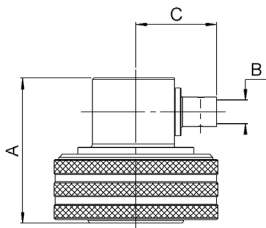

Cable group	Cable group dia.	Part number	Dimensions			Captive center contact	Finish	Coupling mechanism	Note
			A	B	C				
RG402 / KS2	.141"	R183 197 007	21.7	3.65	12.5	yes	Silver + BBR	Push-pull	Solder

Plugs and jacks

RIGHT ANGLE PLUGS FOR CORRUGATED CABLES

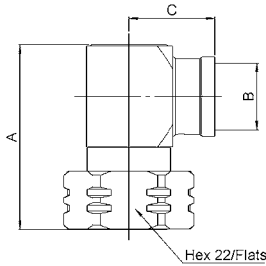

Cable group dia.	Part number	Dimensions			Captive center contact	Finish	Coupling mechanism	Note
		A	B	C				
1/2" superflexible corrugated	R183 165 007	34.7	12.55	16.15	yes	Silver + BBR	Screw-on	Solder

STRAIGHT SQUARE FLANGE JACKS

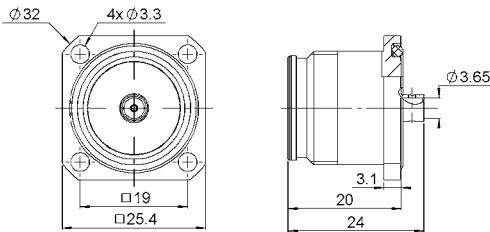

Cable group	Cable group dia.	Part number	Captive center contact	Panel drilling	Finish
RG402	.141	R183 252 007	yes	P01	Silver / BBR

SQUARE FLANGE JACK RECEPTACLES

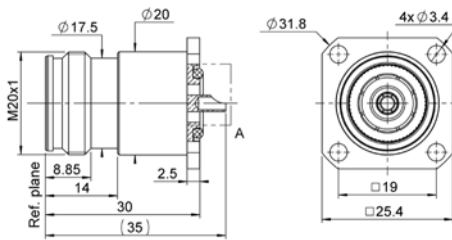

Part number	Captive center contact	Panel drilling	Finish	Note
R183 405 067	yes	P01	Silver / BBR	Solder pot

Connector caps

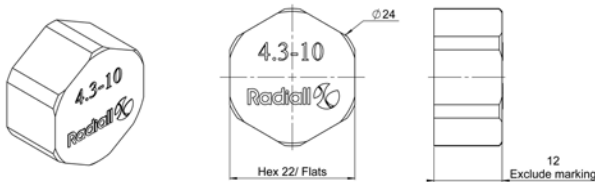

Part number	Note
R183 804 020	IP 67 for mated condition UV resistance

Panel drilling

P01

PANEL CUT OUT

	mm	
	Maxi	mini
A	7.46	7.3
B	3.6	3.5
C	19.05	18.95

Introduction



50Ω

DC - 6 GHz

GENERAL

- Screw-on coupling mechanism
- High power rating
- 20% smaller & 50% lighter than 7/16
- Low coupling torque
- Low intermodulation

APPLICABLE STANDARDS

- IEC 61169
- MIL PRF 39012

APPLICATIONS

- Telecom
- Medical
- Industrial
- Indoor and outdoor use

Overview

Introducing 4.1-9.5, Radiall completes its power connector range with a low intermodulation series. 4.1-9.5 is designed to provide similar performance to 7/16 with smaller size and weight, using a proven screw-on coupling mechanism. With its corrosion resistance, Radiall 4.1-9.5 is the ideal choice for telecom applications where severe conditions require a high performance and robust connector.

HIGH PERFORMANCE

- Impedance 50Ω
- Frequency range DC ~ 6 GHz
- Very low intermodulation level ≤ -125 dBc
- Screw-on coupling mechanism
- Coupling retention force 450 N
- VSWR 1.02 + 0.02 √f
- Meets all requirements for IP67
- High mating life
- Light weight
- Reduced size allows more space for other components
- RF Power: Up to 1000 W @ 1 GHz

Characteristics

Test / Characteristics	Values / Remarks
------------------------	------------------

ELECTRICAL CHARACTERISTICS

Impedance	50Ω
Frequency range	0 - 6 GHz
Typical VSWR	1.02 + 0.02 F
Maximum insertion loss	0.05 √F (GHz)
Insulation resistance	5000 MΩ min
Voltage rating	<=1400 Veff
Dielectric withstanding voltage	<2500 Veff
Contact resistance	≤ 1.5 mΩ
Power	1KW @ 1 GHz
Intermodulation	-160 dBc

MECHANICAL CHARACTERISTICS

Mechanical endurance	100 cycles
Disengagement force	<12 N
Mating torque	1000 N.cm

ENVIRONMENTAL CHARACTERISTICS

Temperature range	- 55 °C ~ + 155 °C
Sealing	IP67

MATERIALS

Connector bodies	Brass
Male center contact	Brass
Female center contact	Beryllium Copper / Bronze
Other metallic parts	Brass
Insulators	PTFE

PLATING

Bodies	BBR2
Outer contact	BBR2
Center contact	Silver

Plugs and jacks

STRAIGHT PLUGS

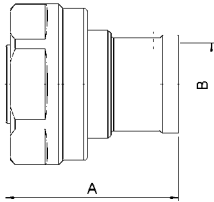

Fig. 1

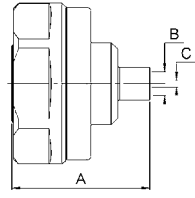

Fig. 2

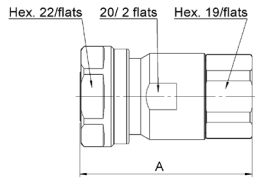
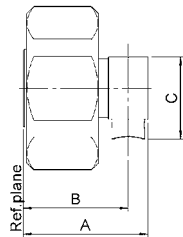

Fig. 3

Cable group dia.	Part number	Fig.	Dimensions			Captive center contact	Finish	Packaging	Note
			A	B	C				
1/2" superflexible corrugated	R170 031 107	1	31.7	12.60	-	yes	Silver / BBR	50	Solder type
Hand formable cable .141"	R170 031 007	2	22	3.65	1.05				Clamp type
1/2" superflexible corrugated	R170 031 207	3	42	-	-				

RIGHT ANGLE PLUG



Cable group	Cable group dia.	Part number	Dimensions			Captive center contact	Finish	Packaging
			A	B	C			
RG402	Hand formable cable .141"	R170 152 107	19	16.00	12.50	yes	Silver / BBR	50

SQUARE FLANGE STRAIGHT JACK

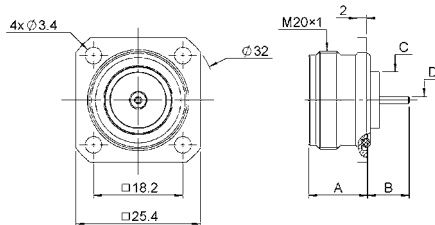

Part number	Dimensions				Captive center contact	Finish	Packaging
	A	B	C	D			
R170 413 127	12	8.50	11.50	1.50	yes	Silver / BBR	50



Miscellaneous: BR2 / Type 43
UHF / IMP / UMP
R605 / R155 / R107 / R214



Contents

TYPE 43

Introduction..... 14-4
 Interface 14-4
 Characteristics 14-5
 Panel drilling 14-8

STANDARD DENSITY

Plugs 14-6
 Sockets..... 14-6
 Receptacles..... 14-6

HIGH DENSITY

Plugs 14-7
 U links..... 14-8

ULTRA HIGH DENSITY

Plugs 14-7

IMP

Introduction..... 14-9 to 14-10
 Characteristics..... 14-11
 Board to board connectors 14-12
 Receptacle packaging..... 14-13
 Assembly instructions 14-12

UMP

Characteristics..... 14-11
 Receptacles..... 14-14
 Pigtails 14-14
 Cable assemblies..... 14-14
 Tools and accessories..... 14-15
 Assembly instructions 14-16

BR2

Interface 14-17
 Characteristics..... 14-17
 Plugs 14-18
 Jacks 14-18
 Receptacles..... 14-19
 Caps 14-19
 Gasket 14-20
 Panel drilling 14-20

UHF

Interface 14-21
 Characteristics..... 14-21
 Plugs 14-22
 Receptacles..... 14-22
 Adapter..... 14-22

TYPE 43

Introduction



75Ω	DC - 3 GHz
-----	------------

GENERAL

- Standard coaxial connectors
- Reliable lock coupling
- 3 types: Standard Density (12.7mm)
High Density (10mm)
Ultra High Density (9mm)

APPLICABLE STANDARDS

- BS9210 F0022

APPLICATIONS

- Telecom DDF (Digital Distribution Frames)

Interface

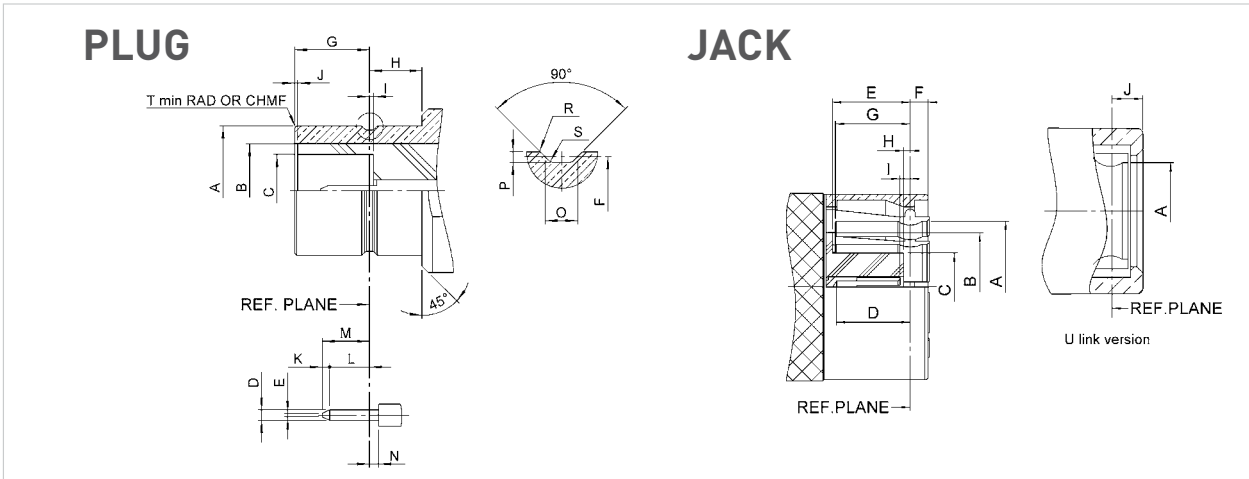

Letter	mm		inch	
	min.	max.	min.	max.
A DIA	6.20	6.23	.244	.245
B DIA	5.25 NOM		.207 NOM	
C DIA	3.4	3.475	.134	.137
D DIA	0.48	0.52	.019	.02
E DIA	0.125	0.225	.005	.009
F DIA	5.97	6.02	.235	.237
G	3.5	3.55	.138	.14
H	2.4	2.55	.095	.1
I	0.05	0.175	.002	.007
J	0.00	0.10	0.00	.004
K	0.25	0.35	.01	.014
L	1.35		.053	
M		2.05		.081
N		0.18		.007
O	0.58 NOM		.023 NOM	
P	0.15	0.25	.006	.01
R	0.05	0.15	.002	.006
S		0.13		.005
T	0.1	0.2	.004	.008

Letter	mm		inch	
	min.	max.	min.	max.
A DIA	6.31	6.36	.248	.25
B DIA	5.25 NOM		.207 NOM	
C DIA	3.22	3.30	.127	.13
D	3.2	3.53	.126	.139
E	3.63	3.83	.143	.151
F		1.8		.071
G	3.61	3.77	.142	.148
H	0.23	0.38	.009	.015
I	0.23	0.48	.009	.019
J	1.475	1.97	.058	.078

Characteristics

TYPE 43 GENERAL TECHNICAL SPECIFICATION

Radiall 75Ω coaxial Type 43 connectors are designed to meet or exceed the requirements of BS9210 F0022. The following information is subject to change without notice. The performance values shown are typical and may not relate to all connector styles available.

Test / Characteristics	Values / Remarks
------------------------	------------------

ELECTRICAL CHARACTERISTICS

Impedance	75Ω
Frequency range	DC - 3 GHz
Temperature range	-40°C to + 100°C
V.S.W.R. (Straight Connectors)	1.20 max
V.S.W.R. (Right Angle Connectors)	1.25 max
Voltage Rating	500 Vrms max
Dielectric Withstanding Voltage	1500 Vrms min
Insulation resistance	5000 MΩ min

MECHANICAL CHARACTERISTICS

Durability	250 matings
Cable retention (Plug connectors) (Socket connectors)	60 to 220 N min***
Center contact retention (Plug connectors) (Socket connectors)	22 N min
Weight	10 g (grams) typical

MATERIALS AND PLATING

Components	Materials	Platings
Body Components*	Brass	Selective Gold
Outer contact	Bronze	Selective Gold
Center contact (male)	Brass	Gold
Center contact (female)	Beryllium Copper	Gold
Insulator	PTFE	Not applicable
Panel Grommet	Polyacetal	Not applicable
Ferrule	Brass	Nickel
Panel Mounting Hardware**	Brass or Phosphor Bronze	Nickel

* In general all Type 43 series connector bodies are gold plated in mating areas.

As a note, the single piece Type 43 connector body is gold plated in the mating area with other surfaces being nickel coated. All multi-piece connector bodies comprise of a gold plated front body (mating area) and a nickel plated back body (crimp area).

** Panel mounting hardware includes components such as - nut, washer, spacer etc.

*** Note, **lower cable retention value** for RG179 - 60 N min and BT3002/TZC 75024 - 150 N min

Plugs, sockets and receptacles - standard density

STRAIGHT SOCKETS CRIMP TYPE FOR FLEXIBLE CABLES

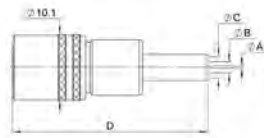

Cable group	Cable group dia.	BT Reference	Part number	Dimensions				Packaging
				A	B	C	D	
BT3002	3.6/75/D	S 43/5 FS	R214 083 922	0.36		4.47	3.2	20 pieces

STRAIGHT BULKHEAD RECEPTACLE WITH SOLDER POT

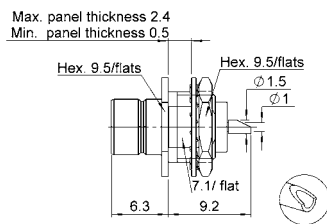

Part number	Panel drilling	Packaging
R214 553 000	P02	Unit

STRAIGHT PCB PLUG RECEPTACLES

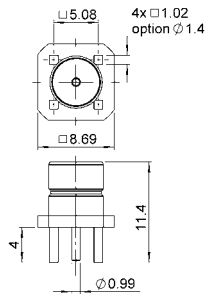

BT Reference	Part number	Panel drilling	Packaging
P 43 / 1 D	R214 426 704	P01	100 pieces

Plugs - high density, sockets and ultra high density

STRAIGHT PLUGS CRIMP TYPE FOR FLEXIBLE CABLES

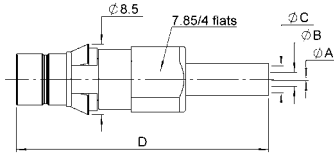

Cable group	Cable group dia.	BT Reference	Part number	Dimensions				Panel drilling	Packaging
				A	B	C	D		
RG179	2.6/75/S	HDC 43/4 GTIS	R214 318 702	0.38	1.73	3.25	35	P03	20 pieces
BT3002	3.6/75/D	HDC 43/5 GTIS	R214 318 722	0.36	2.10	4.47			
RA7000	4.5/75/D	HDC 43/7 GTIS	R214 325 742	0.69	3.00	5.48			

STRAIGHT SOCKETS CRIMP TYPE FOR FLEXIBLE CABLES

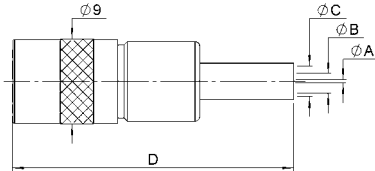

Cable group	Cable group dia.	BT Reference	Part number	Dimensions				Packaging
				A	B	C	D	
RG179	2.6/75/S	HDC 43/4FS	R214 088 902	0.38	1.73	3.25	32	20 pieces
BT3002	3.6/75/D	HDC 43/5FS	R214 088 922	0.35	2.10	4.47	30	

STRAIGHT PLUG CRIMP TYPE FOR FLEXIBLE CABLES

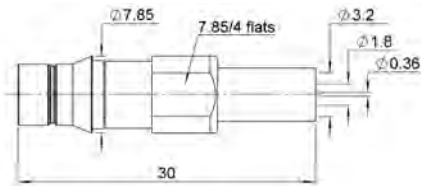

Fig. 1

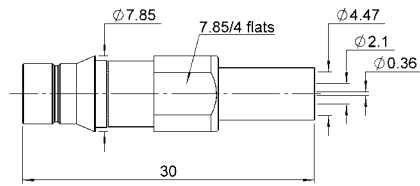

Fig. 2

Cable group	Cable group dia.	BT Reference	Part number	Fig.	Panel drilling	Packaging
RG179	2.6/75/S	UHDC 43/4 GTIS	R214 320 702	1	P04	20 pieces
BT3002	3.6/75/D	UHDC 43/5 GTIS	R214 320 722	2		

TYPE 43

U links - high density

U LINKS

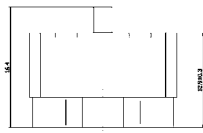

Fig. 1

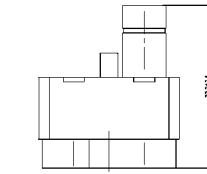

Fig. 2

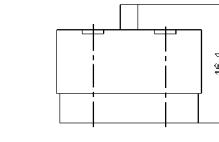

Fig. 3

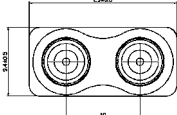

Fig. 4

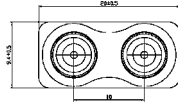

Fig. 5

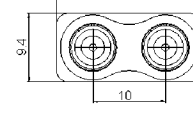
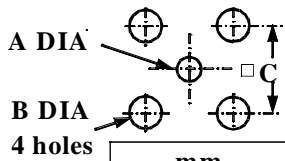

Fig. 6

BT Reference	Part number	Fig.	Packaging
U link 10A	R214 797 703	1	50 pieces
U link 10B	R214 798 703	2	
U link 13A	R214 790 703	3	
U link 13B	R214 791 703	4	
U link 9A	R214 797 723	5	
U link 9B	R214 798 723	6	

Panel drilling

PO1



	mm	
	Maxi	mini
A	1.5	1.2
B	2.0	1.7
C	5.1	5.06

PO2

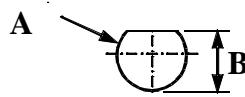

	mm	
	Maxi	mini
A	8.04	7.94
B	7.5	7.4

PO3

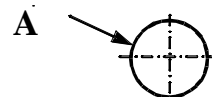

	mm	
	Maxi	mini
A	7.55	7.5

PO4



	mm	
	Maxi	mini
A	7.35	7.05

Introduction

Radiall introduced the MMP contact technology (Micro Miniature Pressure) in 2001 to meet the needs of the telecommunication industry for ultra low profile and cost effective board connectors. The MMP technology can be found in 2 product lines:

- **IMP** series: RF board-to-board application
- **UMP** series: RF board to wire application

BOARD-TO-BOARD APPLICATION



BOARD TO WIRE APPLICATION

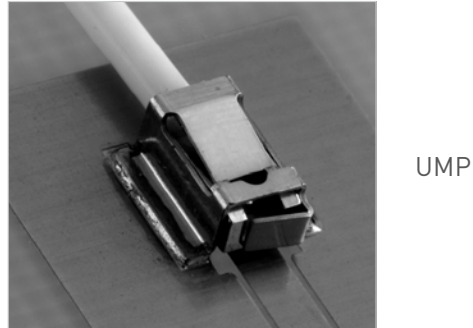

The **IMP** series (Interconnect Micro miniature Pressure contact) consists of 1 coaxial connector when usually the same application requires either 2 coaxial connectors (a male SMT receptacle and a female SMT receptacle), or 3 coaxial connectors (2 SMT receptacles and an adapter).

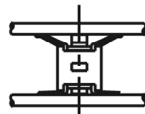

IMP
One piece connector

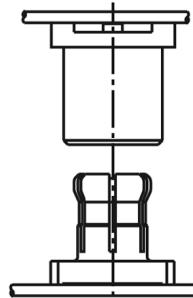

MCX
2 coaxial connectors

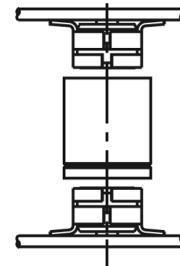

MMS
3 coaxial connectors

The **UMP** series (Ultra Miniature Pressure contact) consists of 1 coaxial plug and 1 SMT edge receptacle.

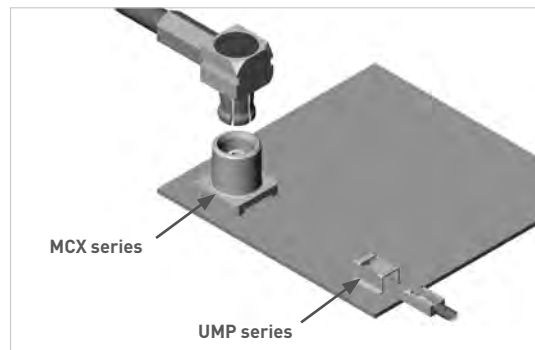

Introduction

IMP PRODUCT FEATURES

- Cost effective solution: one piece connector only
- High density
- World's lightest connector: (example 0.02 g for the IMP 2 mm)
- World's lowest profile for a board-to-board coaxial connexion (2 mm)

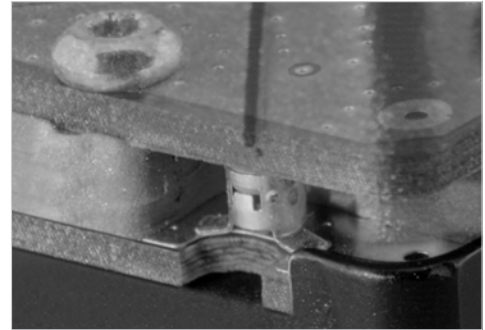

IMP INSTALLATION

The distance between the 2 boards should be precisely ensured by a mechanical device (such as spacers).

Contact Radiall for support regarding the spacers layout in your particular application. Application notes are available upon request.

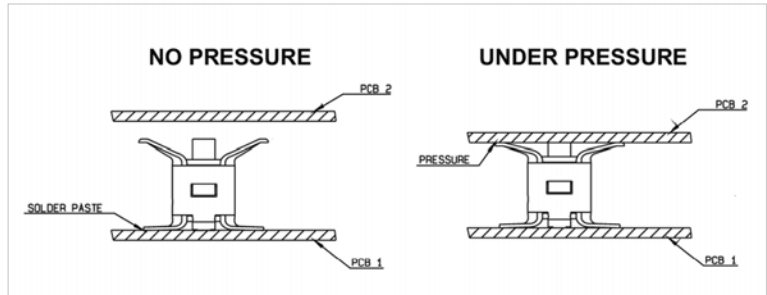

IMP PRODUCT RANGE

IMP is available in 2 mm board-to-board distance. Other heights can be developed upon request.

UMP PRODUCT FEATURES

- Low profile: 2 mm and 3 mm
- Small space for connection: needs only 2 mm of height
- Cost effective solution: 1 coax connector only
- Large cable range from 0.8 to 2.6 mm
- High durability, up to 10,000 cycles

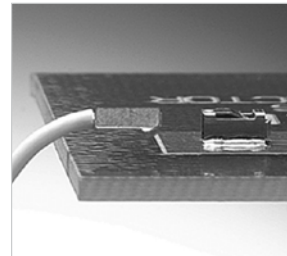

UMP TYPE OF MATING:

- Lock: - can only be disconnected using a tool
- number of matings 100
- withstands severe vibrations
- Snap-on: - number of matings 3000
- Snap-on: - number of matings 10,000
- for test applications

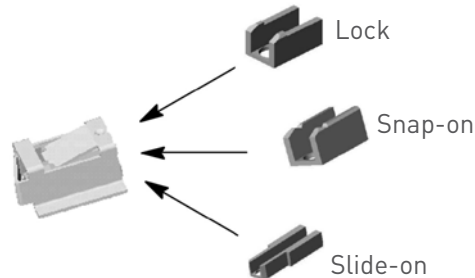

Plug exist with the 3 types of mating:

APPLICATIONS

IMP and UMP series can be used for board-to-board and board-to-antenna applications:

- WLAN
- GPS receivers
- Automotive
- Handheld radios
- RFID

Characteristics

	Values / Remarks	
--	------------------	--

ELECTRICAL CHARACTERISTICS

	IMP	UMP
Impedance	50Ω	
Frequency range	DC-6 GHz	
V.S.W.R. Max	1.3	1.05 + 0.03F (mated connectors)
Insertion Loss (dB)	0.2 V F (GHz)	
RF Leakage	-40dB min at 2 GHz	
Insulation resistance	3000MΩ	1000MΩ min
Contact resistance (depending on PC board) • Center contact • Outer contact	60 mΩ 10 mΩ	
Working voltage	100 VRMS	
Dielectric withstanding voltage	350 VRMS	
Power at sea level, at 20°C	20 W (at 3 GHz)	50 W (at 1.8 GHz)

MECHANICAL CHARACTERISTICS

Durability	> 20	- Lock: 100 - Snap-on: 3000 - Slide-on: 10,000
Weight (g)	0.02	- Receptacle: 0.03 - Plug: 0.08
Axial misalignment from nominal board to board distance in mm (inch)	±0.2 (.008)	N/A
Radial misalignment in mm (inch)	0.2 (.008)	N/A
Force to engage	-	5N
Cable retention force	-	20N - 100N
Sine vibrations	-	IEC 68-2-6
Random vibrations	-	IEC 68-2-36
Shocks	-	IEC 68-2-29
Retention on test board	-	20N min

ENVIRONMENTAL CHARACTERISTICS

Temperature range	-40 / +90°C
-------------------	-------------

MATERIALS

Body/outer contact	Beryllium copper	- Plug: Brass - Receptacle: Beryllium copper
Center contact		Brass (plug only)
Insulator	Polyethercetone	PTFE

PLATING

Body	Gold
Contact	

Board to board connectors

SMT CONNECTORS

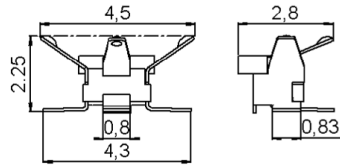

Part number	Height (mm)	Packaging	Reel dimensions A (mm)	Assembly instructions
R107 064 080	2	Reel of 3500	330	M01
R107 064 070		Reel of 100	180	

Assembly instructions

M01

SOLDERING PATTERN

Part number
R107 064 080

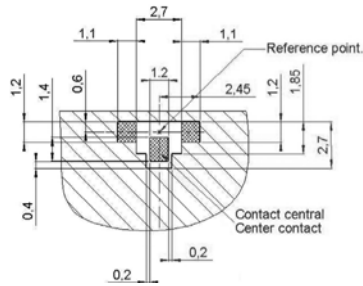

Part number
R107 064 070
R107 064 080

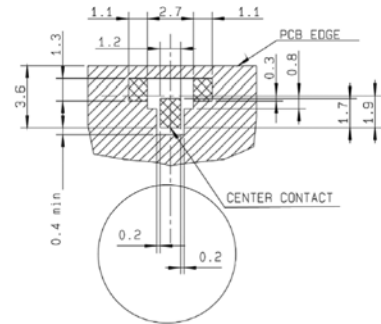

Metallization
Land for solder paste (area free of varnish)

CONTACT PATTERN

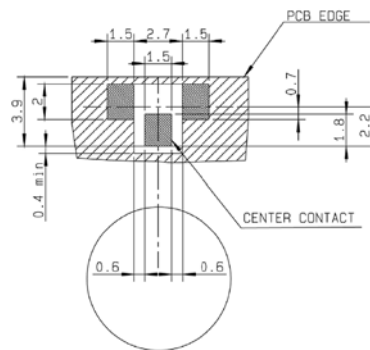
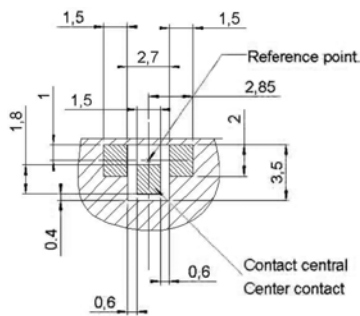

Metallization
Contact area (area free of any surface contaminant)

Receptacle packaging

PROCEDURE FOR USE OF SMT NOZZLE FOR RECEPTACLE

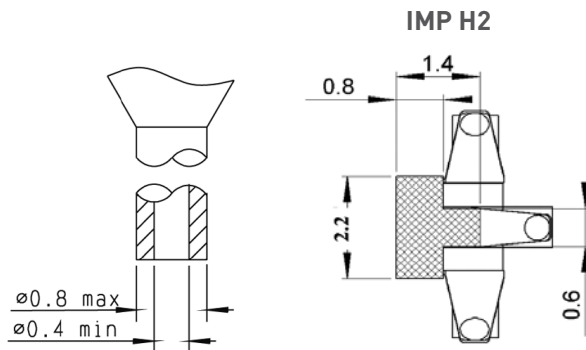

The following pick and place equipment and associated nozzles were successfully tested for the IMP:

- A) FUJI: QP-242/MODULE TYPE
QP-242 IMP MOUNT MODULE NAME: TYPE BI-612
IMP NOZZLE PART N°: I-S12B-013-100 (NOZZLE PIE 1.3)
- B) PANASONIC: MSF type machine
NOZZLE PART N°: 10 807 GH 810

For other equipment, please contact your supplier to define equivalent nozzles.

Receptacles, pigtails and cable assemblies

SMT RECEPTACLES

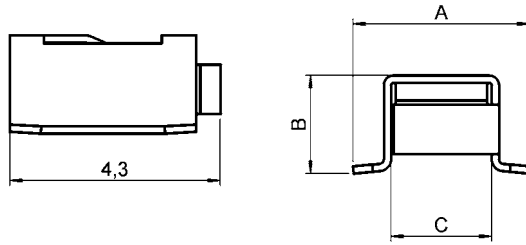
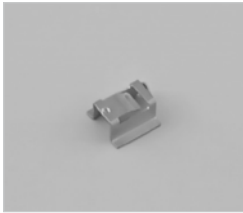

UMP type	Part number	Dimensions (mm)			Finish	Packaging	Reel dimensions (mm)	Assembly instructions
		A	B	C				
H2	R107 003 010	3.6	2	2.05	Gold	100 pieces	180	M02
H3	R107 303 040	5.5	3	2.95				

PIGTAILS

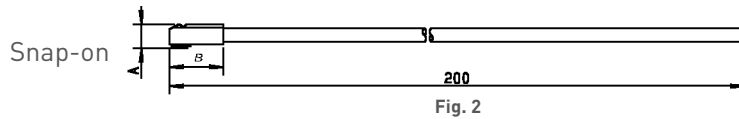
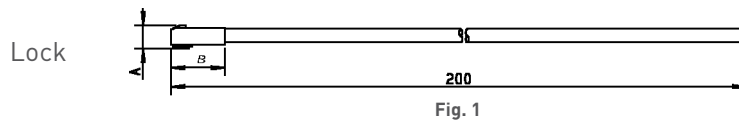

Cable	Cable group	UMP type	Mating type	Part number	Fig.	Dimensions (mm)		Packaging
						A	B	
C291 050 066	1/50/S	H2	lock	R285 020 202	1	1.74	4	100 pieces
			snap-on	R285 020 212	2	1.65		
C291 170 017	2.6/50/S	H3	lock	R285 020 401	1	2.84		

BETWEEN SERIES CABLE ASSEMBLIES

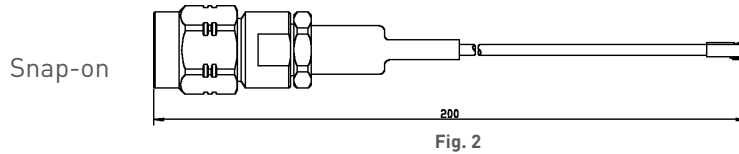
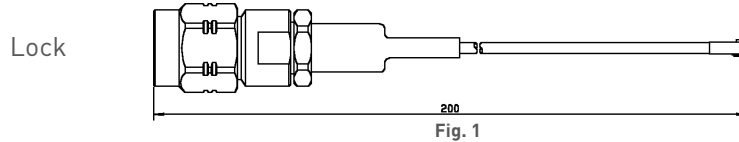

Cable	Cable group	UMP type	Mating type	Part number	Fig.	Series	Packaging
C291 050 066	1/50/S	H2	lock	R285 025 202	1	UMP/SMA	20 pieces
			snap-on	R285 025 212	2		
C291 170 017	2.6/50/S	H3	lock	R285 025 401	1		

Tools and accessories

PRODUCTION LINE TEST ADAPTER: UMP - SMA FEMALE
(to be used with lock and snap pigtails only)

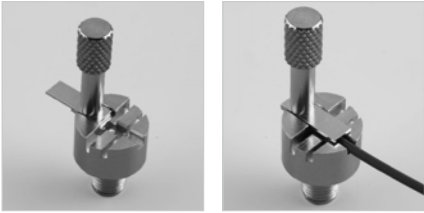

Part number	Connector height (mm)	Packaging
R107 009 901	H 2	Unit
R107 009 903	H 3	

For measurement and test purposes. Packaging: Unit

EXTRACTION TOOL (for lock version only)



Photo 1

Photo 2

Part number	Photo	Note	To disconnect	Packaging
R282 867 020	1	axial disconnection	H 2	10 pieces
R282 867 030	2	lateral disconnection	H 3	

The 2 disconnection tools allows axial and lateral disconnections depending on the occupied space on the PCB.

INSERTION TOOL (optional)



Part number
R282 203 020

This optional tool allows you a more precise connection in a limited space.

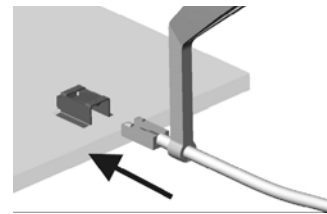

Packaging: Unit

Assembly instructions

M02

RECEPTACLE SOLDERING PATTERNS FOR COPLANAR LINE

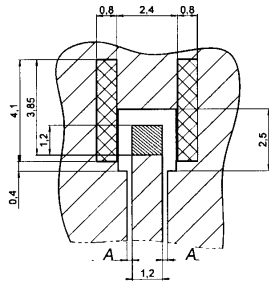

H2 type receptacle

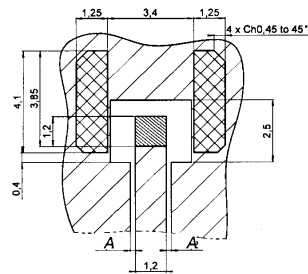

Part number
R107 003 010



H3 type receptacle

Part number
R107 303 040

PCB thickness (mm)	Coplanar ligne A (mm)
0.8	0.183
1.0	0.190
1.2	0.195
1.6	0.20

-  Gold over Nickel preferred for solder paste
Gold can be replaced by tin lead (see test report SC2000.02.6587)
-  Gold over Nickel contact area free of any surface contaminant
-  Ground + varnish

SMT NOZZLE

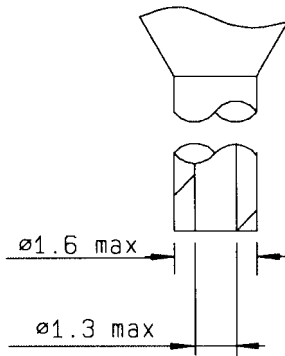

Automated pick and place machines use standard tooling to peel the antistatic film off. Sometimes the "A" dimension of this tool is shorter than the overall "B" width between the two legs of the receptacle. There is therefore a risk for the two legs being deformed while they pass through the tool during the suction operation. The user must then widen the "A" dimension of the peeling tool.

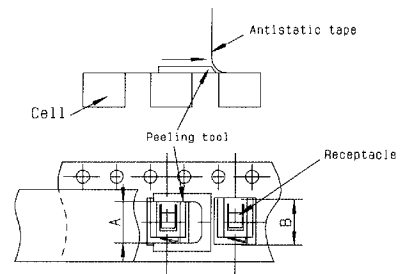

Interface

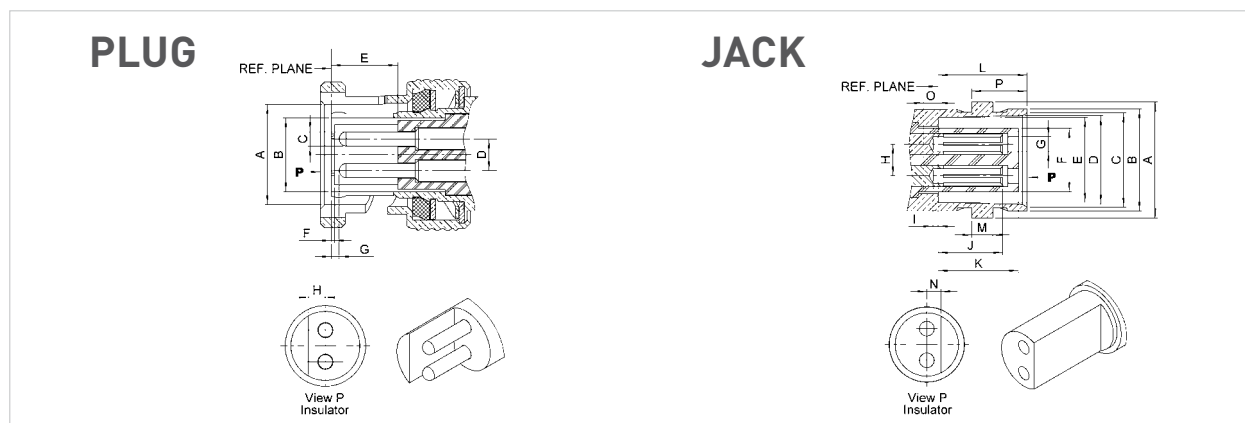

Letter	mm		inch	
	min.	max.	min.	max.
A DIA	9.78	9.91	.385	.390
B DIA	6.70	6.77	.264	.267
C DIA	1.31	1.36	.052	.054
D	2.95	3.05	.116	.120
E	7.6	7.9	.299	.311
F	-0.05	0.15	.002	.006
G	0.85	1.55	.033	.061
H	1.55	1.65	.061	.065

Letter	mm		inch	
	min.	max.	min.	max.
A DIA	10.93	11.09	.430	.437
B DIA	9.60	9.70	.378	.382
C DIA	8.79	9.04	.346	.356
D DIA	8.31	8.46	.327	.333
E DIA	8.09	8.15	.319	.321
F DIA	5.9	6.0	.232	.236
G DIA	1.4	1.45	.055	.057
H	2.95	3.05	.116	.120
I	-0.1	0.8	-.004	.031
J	5.3	5.7	.209	.224
K	7.05	7.35	.278	.289
L	8.36	8.46	.327	.335
M	1.91	2.06	.075	.081
N	1.45	1.55	.057	.061
O	0.35	0.85	.014	.033

Characteristics

Bayonet lock coupling with polarization

ELECTRICAL AND ENVIRONMENTAL CHARACTERISTICS

Dielectric withstanding voltage	between pins between pins and body	1.500 volts RMS, 50 Hz
Maximum intensity		3.5 Amp
Insulation resistance	between pins between pins and body	> 10 ⁵ MΩ
Contact resistance		< 1 mΩ at 1 Amp
Capacity at 1 MHz	between pins between pins and body	< 1.3 pF < 3.2 pF
Frequency range		DC - 0.5 GHz
Temperature range		-40 +100° C

MATERIALS

All metal parts under stress	Beryllium copper
Other metal parts	Brass
Insulators	Polyamide and diallyphtalate
Gaskets	Neoprene

Plugs and jacks

STRAIGHT PLUGS FOR ARMOUR TWINAXIAL CABLE

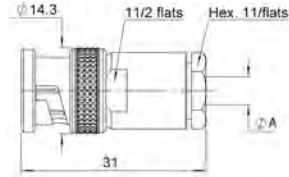

Cable group dia	Part number	Dimensions (mm) A
Twinaxial 4	R605 004 000	4.6
Twinaxial 5	R605 005 000	5.6
Twinaxial 6	R605 006 000	6.6

RIGHT ANGLE PLUG

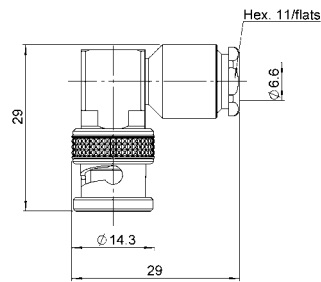

Cable group dia	Part number
Twinaxial 6	R605 156 000

STRAIGHT JACKS

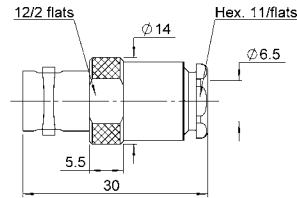

Fig. 1

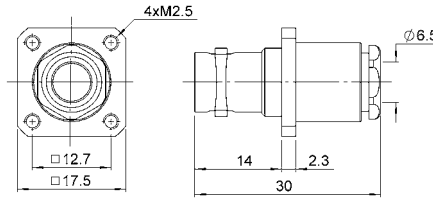

Fig. 2



Cable group dia	Part number	Fig.	Panel drilling	Note
Twinaxial 6	R605 206 000	1	P01	Square flange
	R605 256 000	2		

Receptacles and caps

RECEPTACLES

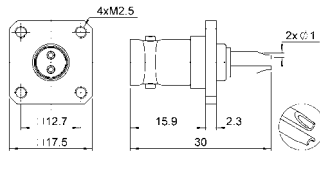

Fig. 1

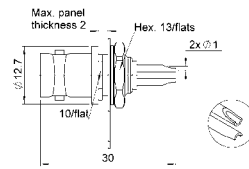

Fig. 2

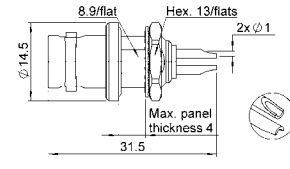
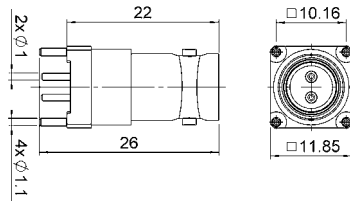

Fig. 3



Part number	Fig.	Panel drilling	Note
R605 400 000	1	P02	Square flange
R605 550 000	2	P04	Rear fixing
R605 550 020			Front mounting
R605 600 000	3	P05	Waterproof

PCB RECEPTACLES



Part number	Panel drilling
R605 440 000	P03

CAPS

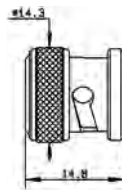

Fig. 1

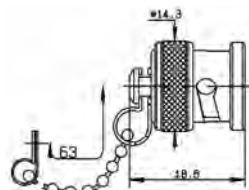

Fig. 2

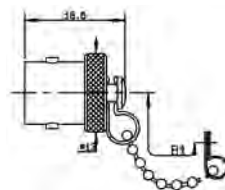

Fig. 3



Part number	Fig.	Note
R141 802 000	1	male
R141 812 000	2	male with chain
R141 842 000	3	female with chain

Gasket

GASKET

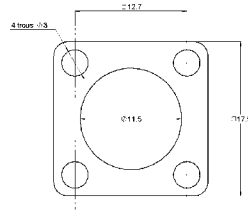

Part number
R280 503 000

Panel drilling

PO1

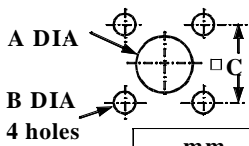

	mm	
	Maxi	mini
A (R. Mount)	11.3	11.2
A (F. Mount)	13	12.9
B	2.7	2.6
C	12.75	12.65

PO2

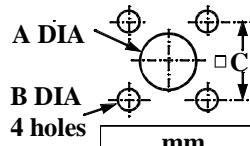

	mm	
	Maxi	mini
A	11.3	11.2
B	2.7	2.6
C	12.75	12.65

PO3

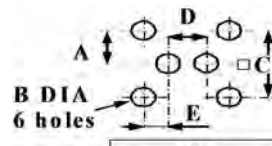

	mm	
	Maxi	mini
A	5.18	4.98
B	1.3	1.2
C	10.26	10.06
D	3.1	2.9
E	3.68	3.48

PO4

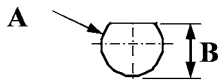

	mm	
	Maxi	mini
A	10.2	10.1
B	11.1	11

PO5

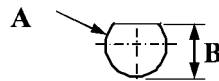

	mm	
	Maxi	mini
A	9.6	9.5
B	9.1	9

Interface

PLUG

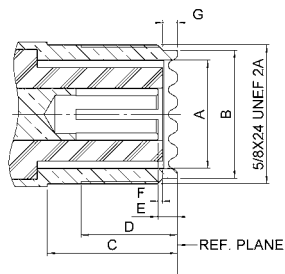

JACK

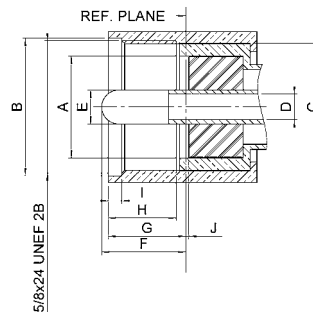

Letter	mm		inch	
	min.	max.	min.	max.
A DIA	11.56	12.22	.455	.481
B DIA	16.00	---	.630	---
C DIA	13.92	---	.548	---
D DIA	---	3.35	---	.132
E DIA	3.912	4.013	.154	.158
F	---	11.10	---	.437
G	---	9.91	---	.390
H	8.76	---	.335	---
I	1.19	4.27	.047	.168
J	0.00	---	.000	---

Letter	mm		inch	
	min.	max.	min.	max.
A DIA	11.56	12.22	.455	.481
B DIA	14.00	14.25	.551	.561
C	11.10	---	.437	---
D	7.87	---	.310	---
E	1.02	---	.040	---
F	0.03	---	.001	---
G	1.19	1.96	.047	.077

Characteristics

Test / Characteristics	Values / Remarks
------------------------	------------------

ELECTRICAL CHARACTERISTICS

Impedance	50Ω
Maximum frequency range	500 MHz
Test voltage (At sea level)	2000 V rms - 50 Hz
Working voltage (At sea level)	750 V
Insulation resistance (Under 500 V)	≤ 5 GΩ
Contact resistance	5 mΩ max
• Centre contact	5 mΩ max
• Outer contact	5 mΩ max

MECHANICAL CHARACTERISTICS

Mating cycles	500
---------------	-----

ENVIRONMENTAL CHARACTERISTICS

Temperature range	• PTFE • Bakelite • Styramic	-55°C to + 155°C -40°C to + 165°C -40°C to + 70°C
Salt spray		48 Hrs

MATERIALS

Contacts and interfaces	Heat treated beryllium copper
Other parts	Brass
Insulator	PTFE (T) - bakelite (B) or styramic (St.)
Gaskets	Neoprene or silicone rubber

All dimensions are given in mm.

Plugs, receptacles and adapter

UHF

STRAIGHT PLUGS

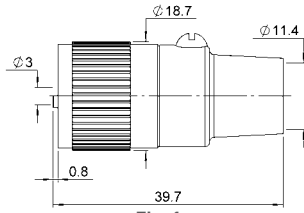
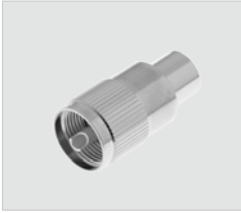

Fig. 1

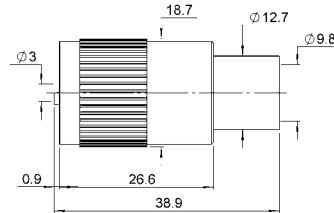

Fig. 2

Cable group	Cable group dia.	Part number	Fig.	Note
RG213 / RG393 / RG11 / RG12 / RG144	10/50+75Ω	R155 003 000	1	Insulator: PTFE
		R155 005 000	2	

RECEPTACLES

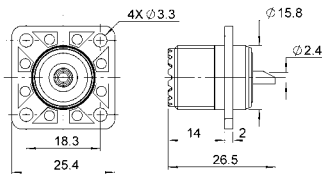

Fig. 1

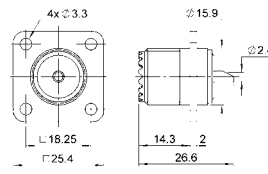

Fig. 2

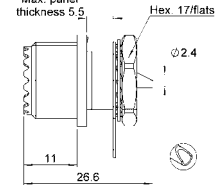

Fig. 3

Part number	Fig.	Panel drilling	Note
R155 404 161	1	P01	Square flange - Solder pot - Insulator: Bakelite
R155 405 000	2		Square flange - Solder pot - Insulator: PTFE
R155 560 000	3	P02	Bulkhead - Solder pot - Insulator: PTFE



**High Voltage Connectors
(BNC HT-MHV / SHV / THT 20 / HN)
Non-Magnetic Connectors**

R316 / R317 / R331 / R176



Contents

HN	
Introduction	15-4
Interface	15-4
Characteristics	15-4
Plugs	15-5
Jacks	15-5
Receptacles	15-5
Adapters	15-6
Caps	15-6
Panel drilling	15-6
HIGH VOLTAGE	
Introduction.....	15-7 to 15-8
BNC HT/MHV	
Characteristics	15-7 to 15-8
Plugs	15-9
Jacks	15-9
Receptacles	15-9
Adapters	15-10
Gasket	15-10
SHV	
Characteristics	15-11
Plugs	15-12
Jacks	15-12
Receptacles	15-13
Adapter	15-13
THT 20	
Characteristics	15-14
Plugs	15-14
Receptacles	15-15
Panel drilling	15-15
NON-MAGNETIC MCX	
Introduction.....	15-16 to 15-19
MMCX Plugs	15-20 to 15-21
Plugs	15-20
Jacks	15-21
Receptacles.....	15-21
NON-MAGNETIC SMP	
Plugs	15-21 to 15-22
Receptacles.....	15-23
NON-MAGNETIC SMB AND BNC	
Plugs	15-21 to 15-22
Jacks	15-22
Receptacles.....	15-23
NON-MAGNETIC CABLE TERMINALS	
Right angle terminal	15-24
Straight terminal	15-23
NON-MAGNETIC CABLE ASSEMBLIES	
Non-magnetic cable assemblies.....	15-25
Panel drilling	15-25

Introduction

The HN series is designed for industries needing accuracy in RF and HV applications up to 5000 Volts. Radiall continuously strives to improve the range of HN coaxial connectors for nuclear and harsh environments. Our customized connectors allow high radiation resistance, and by using a hexagonal nut for mating, they provide a secure connection. Please contact Radiall regarding this dedicated nuclear range.

Interface

PLUG

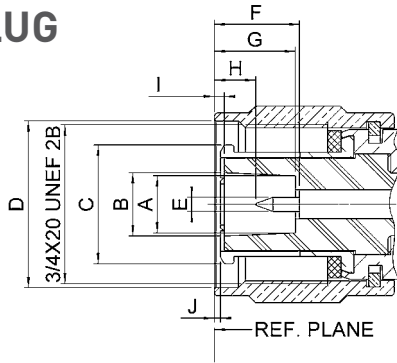

JACK

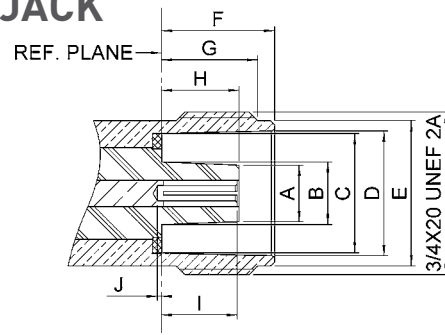

Letter	mm		inch	
	min.	max.	min.	max.
A DIA	6.7	6.8	.264	.268
B DIA	7.4	7.5	.291	.295
C DIA	13.85	13.95	.545	.549
D DIA	19.39	19.59	.763	.771
E DIA	1.62	1.66	.064	.065
F	9.3	10.1	.366	.398
G	9.2	9.7	.362	.382
H	3.9	5.3	.154	.209
I	0.15	0.55	.006	.022
J	-0.5	0.3	.020	.012

Letter	mm		inch	
	min.	max.	min.	max.
A DIA	6.55	6.65	.258	.262
B DIA	7.25	7.35	.285	.289
C DIA	13.91	14.01	.548	.552
D DIA	14.54	14.64	.572	.576
E DIA	16.91	17.01	.666	.670
F	13.2	13.25	.520	.522
G	11.1	11.35	.437	.447
H	8.75	9.25	.344	.364
I	8.55	9.15	.337	.360
J	-1.05	0.15	-.041	.006

Characteristics

ELECTRICAL CHARACTERISTICS

Frequency range	DC to 3 GHz
Impedance	50 Ω
Test voltage at sea level	5000 Vrms (except connector for 5/50-6/75 cable group & adapter M-F: 3000 Vrms)
Insulation resistance	5000 MΩ

MECHANICAL CHARACTERISTICS

Mechanical endurance	500 matings
Vibration	20 g
Shock	1/2 sinusoidal (severity 100 A)

ENVIRONMENTAL

Temperature range	-55°C + 155°C
Salt spray	48 Hrs
Panel sealing	Splashproof

MATERIALS

Contacts and interfaces	Heat treated beryllium copper
Other pieces	Brass / Stainless steel
Insulator	PTFE / Ceramic / PEEK
Gasket	Silicone rubber

PACKAGING

Packaging	Unit
-----------	------

Plugs, jack and receptacle

STRAIGHT PLUGS CLAMP TYPE

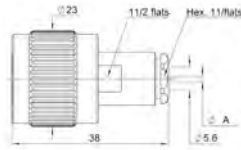

Fig. 1

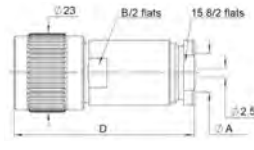

Fig. 2

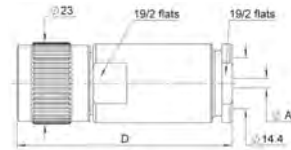

Fig. 3



Cable group	Cable group dia.	Part number	Fig.	Dimensions mm		
				A	B	D
RG58 / RG141 / RG142 / RG223 / RG400	5/50/S+D	R176 006 000	1	5.6		
RG59 / RG62	6/75/S+93	R176 012 000		6.5		
RG213 / RG393 / RG214	10+11/50/S+D	R176 018 000	2	11.2	17	49
		R176 019 000			15.8	56.5
		R176 021 000			17	53
RG 217	14/50	R176 027 000	3	2.5		63

STRAIGHT JACK CLAMP TYPE

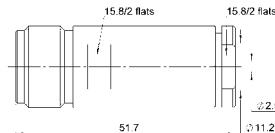

Fig. 1

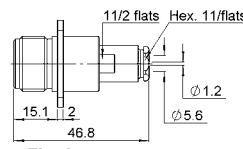
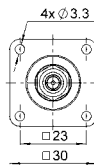

Fig. 2

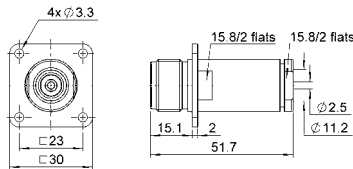
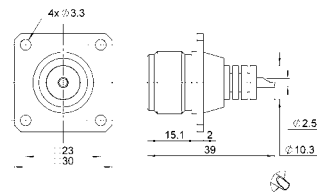

Fig. 3

Cable group	Cable group dia.	Part number	Fig.	Panel drilling	Note
RG213 / RG393 / RG214	10+11/50	R176 218 000	1		
RG58 / RG141 / RG142 / RG223 / RG400	5/50/S+D	R176 256 000	2	P02	Square flange
RG213 / RG393 / RG214	10+11/50	R176 268 000	3		

FLANGE RECEPTACLE



Part number	Panel drilling	Note
R176 404 000	P02	Square flange - Solder pot

Adapters and caps

IN SERIES ADAPTERS

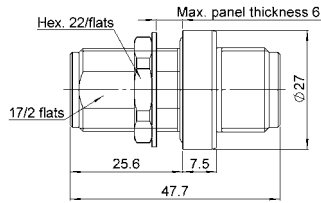

Fig. 1

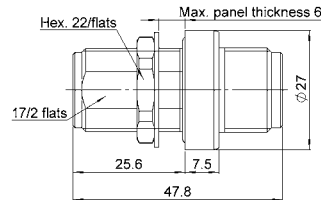

Fig. 2

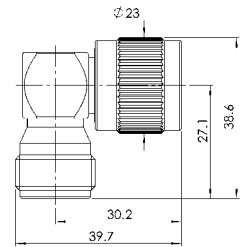

Fig. 3

Part number	Fig.	Panel drilling	Note
R176 754 000	1	P01	Bulkhead female-female - Splashproof panel seal
R176 754 150	2		Bulkhead female-female - Splashproof panel seal - Ceramic insulator
R176 770 000	3		Right angle - male-female

CAPS

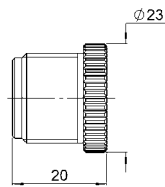

Fig. 1

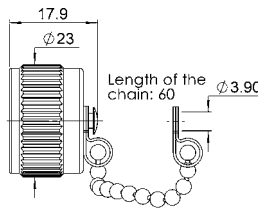
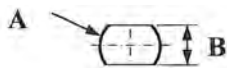

Fig. 2

Part number	Fig.	Note
R176 830 010	1	Protective cap
R176 811 000	2	Protective cap with chain

Panel drilling

PO1



	mm	
	Maxi	mini
A	19.3	19.2
B	17.3	17.2

PO2

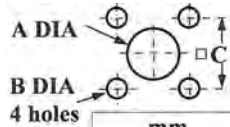

	mm	
	Maxi	mini
A	19.5	19.4
B	3.5	3.4
C	23.1	23

Introduction

This catalogue features 4 series of high voltage coaxial connectors - all able to withstand continuous voltage up to 20 000 V.

By redesigning the BNC HT interface in order to benefit from its high performance to serve MHV, Radiall created BNC HT/MHV. Radiall BNC HT/MHV is fully compatible with BNC HT with MHV interface according to MIL-STD-348.

TEST VOLTAGES

The test voltages quoted in this catalogue are indicative only. They correspond to those made under normal atmospheric conditions during a test period of 1 minute as specified in the French standard NF EN 60068 - 1.

OPERATING VOLTAGES

The operating voltage is chosen under the responsibility of users, depending on the conditions in which the connectors will be used (environment, safety factor...). The indicated cables are recommended for the mechanical and dimensional suitability with our connectors. As to the electrical characteristics of the cables and in particularly the maximum voltage capacity, it is necessary to conform with the recommendation of the cable manufacturer.

Characteristics BNC HT/MHV

BNC HT/MHV connectors are not intermateable with the BNC and SHV series.

ELECTRICAL CHARACTERISTICS

Frequency range	DC - 2 GHz
Impedance	50Ω
VSWR (plug and jack)	1.20 + 0.2 F (GHz)
Test voltage <ul style="list-style-type: none"> • Unmated (Male) • Connectors (Female) • Mated pair 	6 000 V D.C.
	6 000 V D.C.
	10 000 V D.C.
Current rating	10 A

MECHANICAL AND ENVIRONMENTAL CHARACTERISTICS

Mating cycles	500
Vibration	20 g - 2 000 Hz
Shock	50 g
Salt spray	48 H
Temperature range	- 55°C + 155°C - 40°C + 70°C (with polyethylene insulator)

MATERIALS AND PLATING

Components	Materials	Platings
Body	Brass	Nickel
Center contact	Brass / Beryllium copper	Silver
Other metal parts	Brass or Beryllium copper	Nickel
Insulator	PTFE / Polyethylene	
Gasket	Silicone rubber	

All dimensions are given in mm.

Plugs, jacks and receptacles

STRAIGHT PLUGS FOR FLEXIBLE CABLES

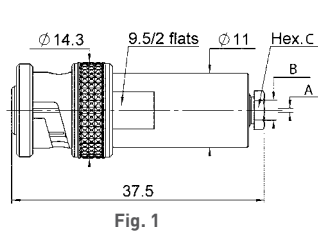

Fig. 1

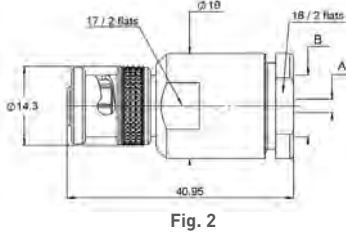

Fig. 2

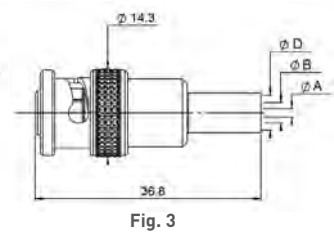

Fig. 3

Cable group	Cable group dia.	Part number	Fig.	Dimensions				Note
				A dia.	B dia.	Hex. C	D dia.	
RG174 / RG316 / RD316 / RG179 / RD179	2.6/50+75/S + D	R316 004 000	1	0.6	3	5/flats	-	Clamp type
RG58 / RG141 / RG142 / RG223 / RG400	5/50/S + D	R316 007 000		1.2	5.6	9.5/flats	-	
RG59/RG62	6/75/S	R316 011 000		1.2	6.5	9.5/flats	-	
RG58/RG141	5/50/S	R316 072 000	3	1.2	3.2	-	5.6	Crimp type
RG214 / RG393 / RG213	10/50/S+D	R316 020 010	2	2.5	11.2	-	-	Clamp type
RG59 / RG62	6/75/S	R316 072 010	3	1.2	4	-	6.6	

STRAIGHT JACKS CLAMP TYPE FOR FLEXIBLE CABLES

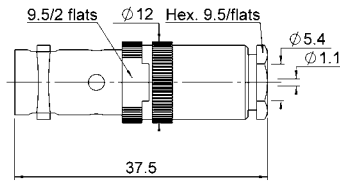

Fig. 1

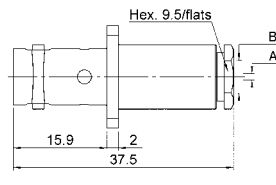

Fig. 2

Cable group	Cable group dia.	Part number	Fig.	Dimensions			Panel Drilling
				A	B	C	
RG58 / RG141 / RG142 / RG223 / RG400	5/50/S + D	R316 207 000	1	1.1	5.4	37.5	P01
RG59 / RG62	6/75S	R316 211 000			6.5	38.5	
RG58 / RG141 / RG142 / RG223 / RG400	5/50/S+D	R316 257 000	2		5.4	37.5	
RG59 / RG62	6/75/S	R316 261 000			6.5		

Receptacles, adapters and gasket

RECEPTACLES

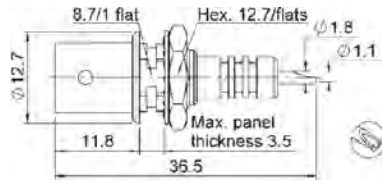

Fig. 1

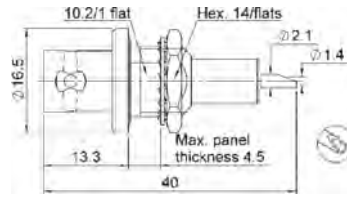

Fig. 2

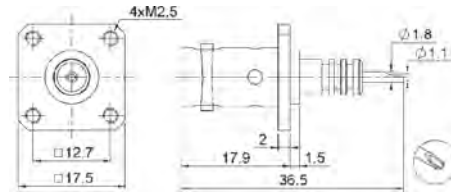

Fig. 3

Part number	Fig.	Panel Drilling	Note
R316 553 000	1	P02	Bulkhead
R316 603 000	2	P03	Bulkhead panel seal
R316 405 000	3	P01	Square flange mounting

IN SERIES ADAPTERS

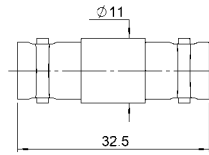

Fig. 1

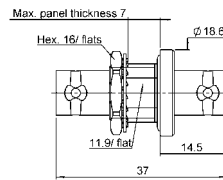
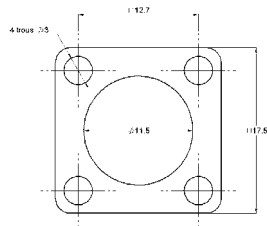

Fig. 2

Part number	Fig.	Panel Drilling	Note
R316 704 000	1		Straight female - female
R316 754 000	2	P04	Straight bulkhead female - female with panel seal

GASKET



Part number
R280 503 000

Introduction

These safe high voltage connectors meet all requirements of the NIM Standard (Nuclear Instrumentation Module) Specification ND 545 Amendment A. Both the pin and socket contacts are securely recessed inside the insulation to guard against potential electrical shock when live unmated connectors are handled.

They are particularly recommended for impulse circuits of linear accelerators as well as in military, nuclear and medical electronics.

These connectors are not intermateable with the BNC and BNC HT/MHV series.

Characteristics

ELECTRICAL CHARACTERISTICS

Frequency range		DC - 2 GHz
Impedance		50Ω
VSWR (plug and jack)		< 1.20 + 0.3 F (GHz)
Contact resistance	• Center contact	< 2.1 mΩ
	• Outer contact	< 1.5 mΩ
Test voltage	• Unmated connectors	10 000 V D.C.
	• Mated pair	12 000 V D.C.
Current rating		10 A

MECHANICAL AND ENVIRONMENTAL CHARACTERISTICS

Temperature range		- 65°C + 165°C
Mating cycles		500
Vibration		10 g - 500 Hz to MIL-STD-202, method 204, condition A
Shock		To MIL-STD-202, method 213 B, condition A
Salt spray		To MIL-STD-202, method 101, condition B-48 H
Contact to cable retention force		> 27 N
Coupling nut retention force		> 450 N
Cable retention		> 180 N

MATERIALS AND PLATING

Components	Materials	Plating
Body	Brass	Nickel
Center contact	Brass / Beryllium copper	Gold
Other metal part	Brass / Beryllium copper	Nickel
Insulator	PTFE	
Gasket	Silicone rubber	

Plugs

STRAIGHT PLUGS FOR FLEXIBLE CABLES

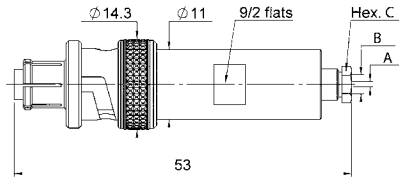

Fig. 1

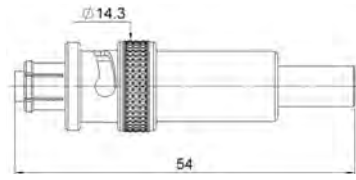

Fig. 2

Cable group	Cable group dia.	Part number	Fig.	Dimensions			Captive center contact	Note
				A dia.	B dia.	Hex. C		
RG58 / RG141 / RG142 RG223 / RG400	5/50/S + D	R317 005 000	1	1.05	5.6	9.5/flats	yes	Clamp type
RG58 / RG141 RG59 / RG62	5/50/S 6/75/S	R317 072 000 R317 074 000	2					Crimp type

All dimensions are given in mm.

Jacks

STRAIGHT JACKS FOR FLEXIBLE CABLES

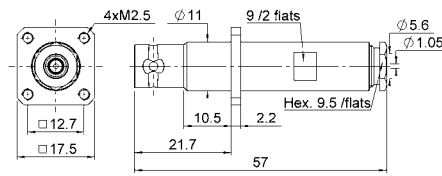

Fig. 1

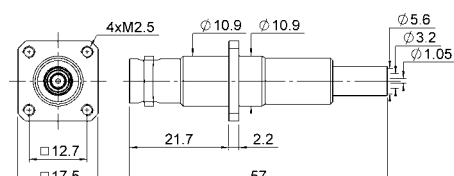

Fig. 2

Cable group	Cable group dia.	Part number	Fig.	Panel Drilling	Captive center contact	Note
RG58 / RG141 / RG142 RG223 / RG400	5/50/S + D	R317 255 000	1	P01	yes	Square flange clamp type
RG58 / RG141	5/50/S	R317 270 000	2		Square flange crimp type	

Receptacles and in series adapter

SHV

RECEPTACLES

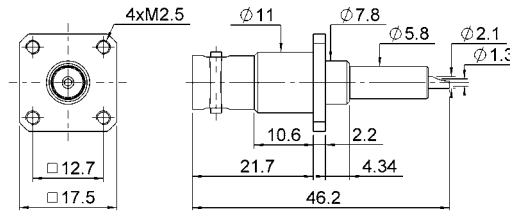
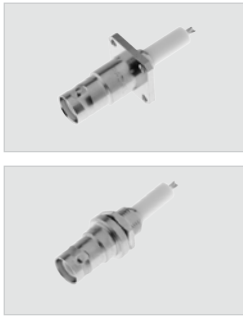

Fig. 1

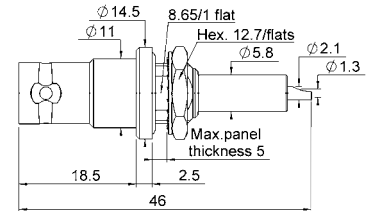
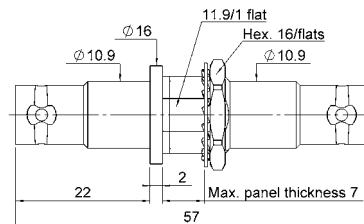

Fig. 2

Part number	Fig.	Panel Drilling	Note
R317 405 000	1	P05	Square flange
R317 580 000	2	P06	Bulkhead

IN SERIES ADAPTER



Part number	Panel Drilling	Note
R317 720 000	P04	Bulkhead jack - jack

Introduction

This large size screw-on interface has a 4 mm internal diameter female center contact which allows testing with standard banana plugs. THT 20 features the highest test voltage with a rating of 20 000 VDC for a mated pair.

Characteristics

Female center contact has a 4 mm internal diameter which allows testing with standard banana plugs.

- Screw coupling

ELECTRICAL CHARACTERISTICS

Frequency range		DC - 1 GHz
Impedance		50Ω
Test Voltage	• Unmated connectors	10 000 V D.C.
	• Mated pair	20 000 V D.C.
Current rating		20 A

MECHANICAL AND ENVIRONMENTAL CHARACTERISTICS

Temperature range	- 40°C + 70°C (polyethylene or styramic insulators) -55°C + 125°C (PTFE insulator)
Mating cycles	500
Salt spray	48 H

MATERIALS AND PLATING

Components	Materials	Plating
Body	Brass	Nickel
Center contact	Brass / Beryllium copper	Gold / Silver
Other metal part	Brass	Nickel
Insulator	PTFE / Polyethylene	
Gasket	Silicone rubber	

Plugs

STRAIGHT PLUGS, CLAMP TYPE FOR FLEXIBLE CABLES

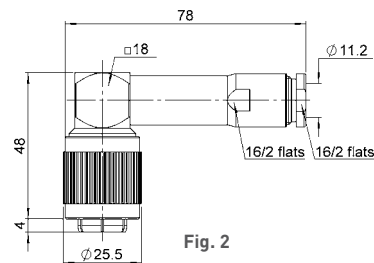
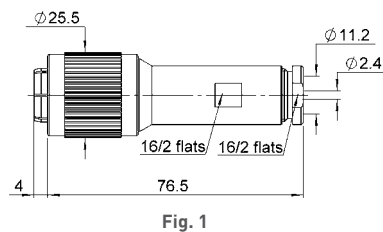

Cable group	Cable group dia.	Part number	Fig.	Note
RG213 / RG393 / RG214	10/50+75/S + D + 11/50+75/D	R331 018 000	1	Straight / PE insulator
RG11 / RG12 / RG144 / RG216		R331 168 000	2	Right angle

Receptacles

RECEPTACLES

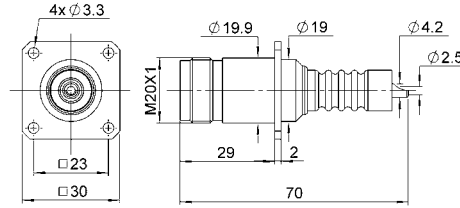

Fig. 1

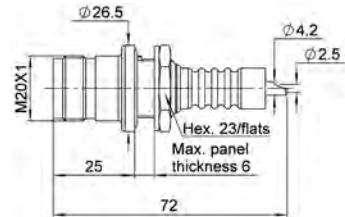
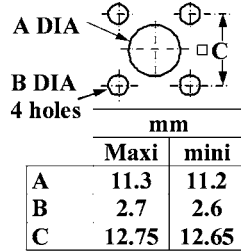

Fig. 2

Part number	Fig.	Panel drilling	Note
R331 405 000	1	P07	Square flange - PTFE insulator
R331 603 000	2	P08	Bulkhead, panel seal PTFE insulator

Panel drilling

P01



P02

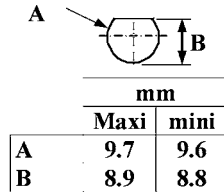

P03

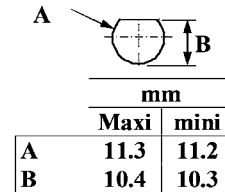

P04

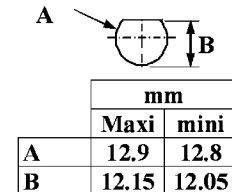

P05

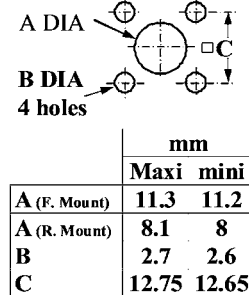

P06

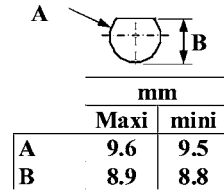

P07

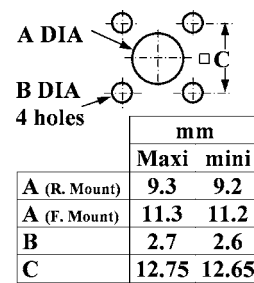

P08

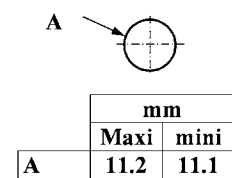

P09

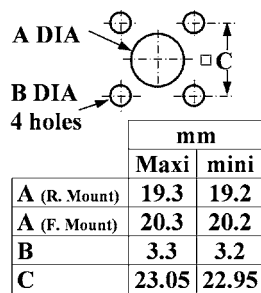

P10



P11

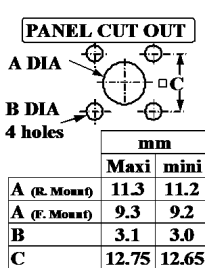

All dimensions are given in mm.

Introduction

Radiall . . . The Best Choice for Non-Magnetic Connectivity Solutions

We Know Your Market

We offer a range of non-magnetic RF connectors and cable assemblies for medical and space applications.

Why Radiall Is Your Best Choice

- Collaboration: We work closely with your engineers to understand your business, your technical needs, and your budget.
- High Performance, Competitively Priced Products: Our connectivity solutions give you the best combination of performance and value.
- Wide Product Range: We manage our product lines through the entire lifecycle, in order to offer you a wide selection of standard products at an affordable price.
- Global Presence: We're everywhere you need us, with worldwide sales, engineering support, R&D in North America, Europe, and Asia, and manufacturing facilities strategically located in the United States, Mexico, France, India, and China to provide on-demand cable assemblies.
- Responsive Support and Service: From the design stage, and planning to post-installation support, we're with you at every step, whether you need sales support or engineering expertise.
- Warranty: We stand behind our products.



Certifications and Environment

Radiall is ISO 9001:2008 certified and dedicated to continuous improvement programs that have resulted in AS9100, TS16949, and ISO 14001 certifications. In addition, Radiall is committed to investing in its people, future technologies, and the environment. Radiall is RoHS (Restriction of Hazardous Substances) and REACH (Registration, Evaluation, Authorization and Restriction of Chemical Substances) compliant.

The Best Manufacturing and Process Technologies

Our dedication to innovation and continuous improvement in leading-edge products means we excel in the techniques to create them:

- High precision machining: metal stamping, milling, turning, and cutting
- Molding, polishing
- Laser, ultrasonic, and vapor soldering
- Plating and plastic metallization
- Automatic assembly
- Characterization
- Test and measurement
- Cable and PTFE wrapping
- Thin and thick-film processes

Introduction

NON-MAGNETIC CONNECTOR FAMILIES

Radiall offers a growing range of non-magnetic connectors for medical, space, and other applications that includes MMCX, MCX, SMP, and SMB interfaces. To guarantee an exceptional non-magnetism level and repeatability, each non-magnetic connector is manufactured through a strictly controlled production process according to our quality assurance procedures.

For space applications, such as satellites used for scientific exploration, we offer an extensive range of SMA products, fully ESA qualified, meeting the residual magnetism required by the ESCC 3402 generic specification and the ESCC 3402/001, 002, and 003 detail specifications. Connectors are made of beryllium copper with gold plating and copper underplating.

NEW NON-MAGNETIC MCX SERIES

Radiall has expanded our range of non-magnetic connectors with the non-magnetic MCX series. These connectors meet the need for smaller interconnections in space-limited MRI equipment, such as those for head, shoulder, or foot. With more reliable connections through superior performance, the reinforced connection system eliminates the risk of perturbation in image quality.

The non-magnetic MCX family also includes a new full-detent cable version, which has been tested in high-vibration conditions, that eliminates intermittent connections. It complies with MIL-STD-202, Method 204, Condition D for vibration testing.

Non-magnetic MCX connectors are available in a wide range of configurations for:

- Board-to-board connections
- Cable-to-board connections
- Cable-to-cable connections

NON-MAGNETIC CABLE ASSEMBLIES

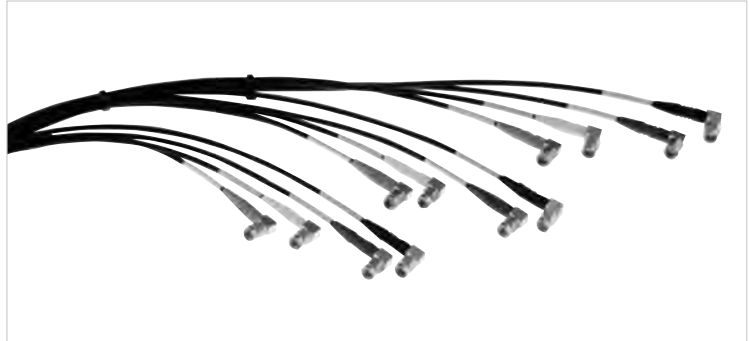
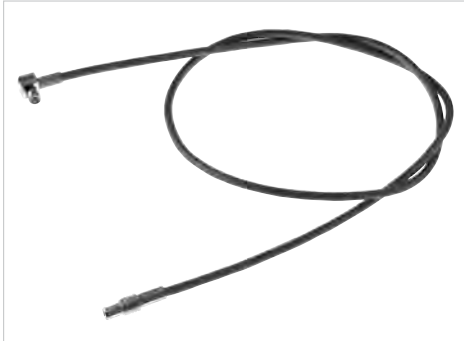

Radiall offers non-magnetic cable assemblies that provide a totally non-magnetic solution to reduce the risk of perturbation while working inside the B_0 magnetic field. Non-magnetic cables are available in RG/316, RG/178 flexible or .085" and .141" semi-rigid styles.

Introduction



CUSTOM PRODUCTS

We are continually developing new non-magnetic products, including high-density, multiposition configurations.

Multi-port connectors: We offer a wide variety of solutions for high-density coaxial contacts based on the standard SMP, Coaxipack 2, SMB and SMA ranges with additional multiple DC contacts. Our expertise and extensive knowledge in RF coaxial connector and cable assembly technology allows us to offer superior technical project support including those projects that need new coaxial connections developed. Multi-port connectors offer the advantage of having only one connector instead of several separate connectors to mate and unmate.

Non-magnetic RF CONNECTORS FOR MEDICAL

Non-magnetic coaxial connectors are used primarily inside MRI and other medical imaging equipment. Magnetic resonance imaging produces high-resolution cross-sectional images of the inside of the human body by exploiting radio frequency (RF) pulses. MRI technology has seen tremendous improvements in recent years with continued advances in technology, a small part of which is due to coaxial non-magnetic connectors.

MRI medical equipment consists of a large magnet or electromagnet to create an intense and homogenous magnetic field (0.3 to 7 T) that surrounds the patient, “gradient coils” to position the area under analysis, and two high-frequency coils. One coil transmits RF pulses of 20 to 300 MHz to excite the atomic nucleus in the area under analysis. The other coil receives a signal that constitutes the image after excitation. The output is sent to a computer for processing and display.

The quality of the picture depends mainly on the homogeneity of the magnetic field and on the signal-to-noise ratio. To avoid any interference in the field homogeneity, coaxial connectors and cables located in the magnetic field to connect the coils should be transparent relative to the field, which means their relative permittivity μ_r should be equal to 1.

High-quality non-magnetic connectors have extremely low magnetic susceptibility so that they are not magnetized by the fields created in the equipment.



Introduction

RADIAL NON-MAGNETIC CONNECTORS

Radiall connectors are specified for coils because they are manufactured with materials especially adapted to non-magnetism (with relative permittivity μ_r close to 1). Each rod of raw material is selected based on a direct measurement with a vibrant magnetometer, with the highest quality of surface plating such as BBR (Bright Bronze Radiall), or NPGR (gold plated over a non-magnetic nickel phosphorous).

Our non-magnetic connectors have a susceptibility of around 10^{-5} , as opposed to 10^{-2} for standard connectors made of brass/nickel materials. As a result, our non-magnetic connectors are transparent to the magnetic field, which means no field distortion, a higher SNR, and higher quality images.

Performance of Radiall non-magnetic RF connectors

Table of distortion comparison:

	Distortion at 10 mm $\Delta H/H_{\text{ext}}$ with $B_0=1.5$ Tesla	Magnetic susceptibility χ
Radiall non-magnetic connector	$\leq 5 \cdot 10^{-7}$	$\approx 10^{-5}$
Standard non-magnetic connector	$\approx 10^{-5}$	$\approx 10^{-3}$
Brass/nickel connector	$\approx 10^{-4}$	$\approx 10^{-2}$

The relative distortion of a magnetic field of 1.5 T, generated by Radiall non-magnetic connectors is only $5 \cdot 10^{-7}$ maximum, at a distance of 10 mm from the surface of the connector. Furthermore, they meet the electrical and mechanical characteristics required for any reliable coaxial connector. In addition, these connectors are extremely durable for medical applications.

Manufacturing

Manufacturing a Radiall non-magnetic connector involves a special “clean room” environment where all precautions are taken to avoid any contact with ferromagnetic materials during the machining and cleaning process. Radiall follows strict manufacturing guidelines through a quality assurance plan where documented rules are enforced throughout the production line. This quality assurance procedure guarantees the highest level of non-magnetism and repeatability for all Radiall non-magnetic connectors.

MMCX plug and PCB receptacle

RIGHT-ANGLE PLUG CRIMP TYPE FOR FLEXIBLE CABLE

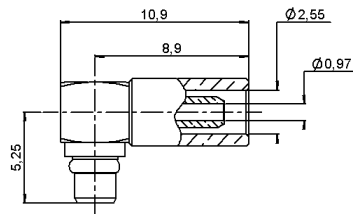

Cable group	Cable group dia.	Part number	Captive center contact	Body material	Finish
RG178 Non-magnetic cable	2/50/S	R110 170 147	yes	Non-magnetic bronze	BBR

STRAIGHT PCB RECEPTACLE

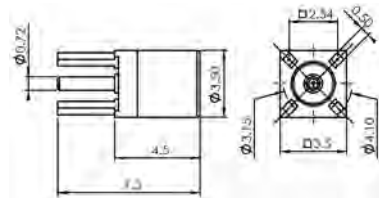

Part number	Captive center contact	Panel drilling	Body material
R110 426 107	yes	P01	Non-magnetic Bronze

MCX plug

STRAIGHT PLUG CRIMP TYPE FOR FLEXIBLE CABLE

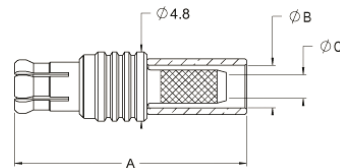

Cable group	Cable group dia.	Part number	Dimensions (mm)			Note	Finish
			A	B	C		
RG178	2/50/S	R113 081 097	16.1	2.55	1.1	—	BBR
RG316	2.6/50/S	R113 082 097	16.1	2.95	1.65	—	
RG316	2.6/50/S	R299 122 097	16.1	2.95	1.65	Full detent	

RIGHT-ANGLE PLUG CRIMP TYPE FOR FLEXIBLE CABLE

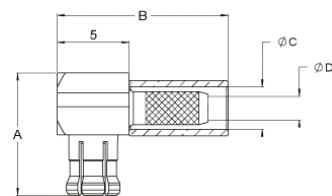

Cable group	Cable group dia.	Part number	Dimensions (mm)				Note	Finish
			A	B	C	D		
RG178	2/50/S	R113 181 097	8.6	11.9	2.55	1.1	—	BBR
RG316	2.6/50/S	R113 182 097	8.6	11.9	2.95	1.65	—	
RG316	2.6/50/S	R299 122 087	8.6	11.9	2.95	1.65	Full detent	

PRODUCT SPECIFICATION: please refer to the standard range

Our Most Important Connection is with You.™

MCX jack and PCB receptacles

STRAIGHT JACK CRIMP TYPE FOR FLEXIBLE CABLE

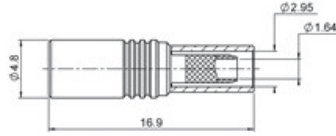

Cable group	Cable group dia.	Part number	Finish
RG316	2.6/50/S	R113 240 097	BBR

STRAIGHT PCB RECEPTACLE

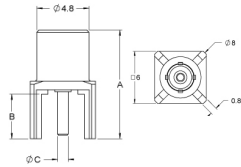
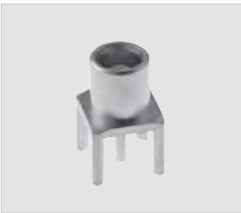

Fig. 1

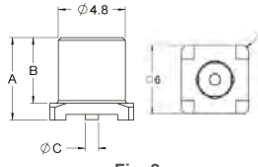

Fig. 2

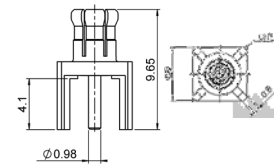
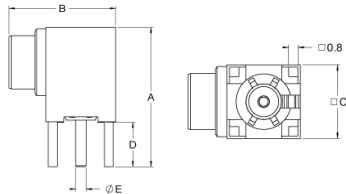

Fig. 3

Part number	Fig.	Dimensions (mm)			Panel drilling	Termination	Finish	Type
		A	B	C				
R113 426 097	1	10	4.1	0.98	P01	Solder legs	Gold over copper	female
R113 424 097	2	5.9	4.7	0.96	--	SMT		female
R113 425 097	3	9.65	4.1	0.98	P01	Solder legs		male

RIGHT-ANGLE PCB RECEPTACLE



Part number	Panel drilling	Termination style	Finish	Type
R113 665 097	P01	Solder legs	Gold over copper	female

SMP plug

RIGHT-ANGLE PLUG CRIMP TYPE FOR FLEXIBLE CABLE

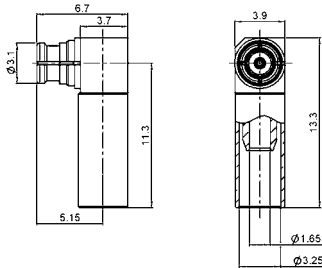

Cable group	Cable group dia.	Part number	Captive center contact	Body material	Finish
RG179 non-magnetic cable	2.6/50/S	R222 900 357	yes	Non-magnetic bronze	BBR

PRODUCT SPECIFICATION: please refer to the standard range

SMP receptacle

STRAIGHT SMT RECEPTACLE

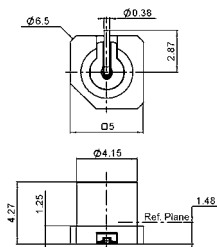

Part number	Retention	Captive center contact	Body material	Finish
R222 941 324	Limited detent	yes	Non-magnetic bronze	Gold over copper

SMB Plugs and jack

STRAIGHT PLUG FULL CRIMP TYPE FOR FLEXIBLE CABLE

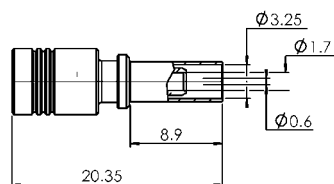

Cable group	Cable group dia.	Part number	Captive center contact	Body material	Finish
RG179, RG316 non-magnetic cable	2.6/50+75/S	R114 082 107	yes	Non-magnetic bronze	BBR

RIGHT-ANGLE PLUG CRIMP TYPE FOR FLEXIBLE CABLE

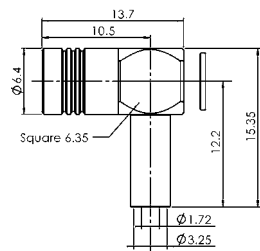
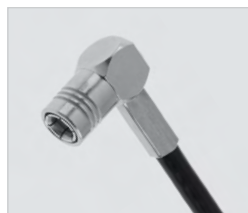

Cable group	Cable group dia.	Part number	Captive center contact	Body material	Finish
RG179, RG316 non-magnetic cable	2.6/50+75/S	R114 186 197	yes	Non-magnetic bronze	BBR

STRAIGHT BULKHEAD JACK CRIMP TYPE FOR FLEXIBLE CABLE

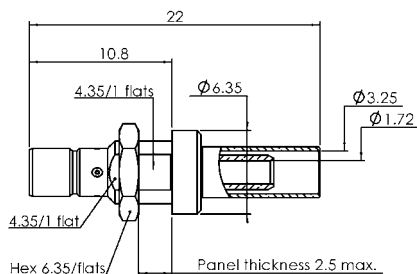

Cable group	Cable group dia.	Part number	Captive center contact	Panel drilling	Body material	Finish
RG316 non-magnetic cable	2.6/50+75/S	R114 313 197	yes	P02	Non-magnetic bronze	BBR

PRODUCT SPECIFICATION: please refer to the standard range

SMB receptacle

STRAIGHT MALE RECEPTACLE FOR PCB

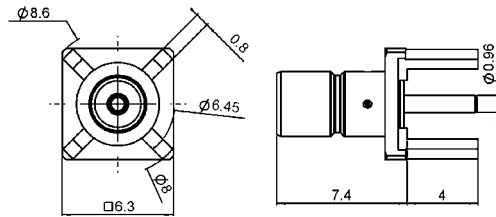

Part number	Body material	Finish
R114 426 147	Non-magnetic bronze	Gold over copper

RIGHT-ANGLE RECEPTACLE FOR PCB, SOLDER LEGS

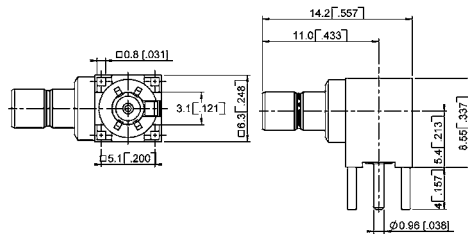

Part number	Captive center contact	Body material	Finish
R114 665 107	yes	Non-magnetic bronze	Gold over copper

BNC plugs and jack

STRAIGHT PLUG FULL CRIMP TYPE

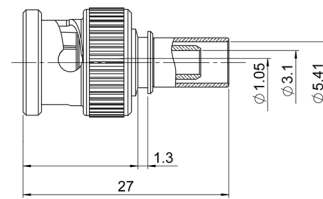

Cable group	Cable group dia.	Part number	Captive center contact	Body material	Finish
RG58 / RG141	5/50S	R141 082 097	yes	Non-magnetic bronze	BBR / Gold

RIGHT-ANGLE PLUG CRIMP TYPE FOR FLEXIBLE CABLE

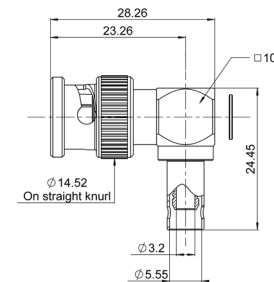

Cable group	Cable group dia.	Part number	Captive center contact	Body material	Finish
RG58 / RG141	5/50S	R141 182 177	yes	Non-magnetic bronze	BBR / Gold

STRAIGHT BULKHEAD JACK SOLDER TYPE FOR SEMI RIGID CABLE

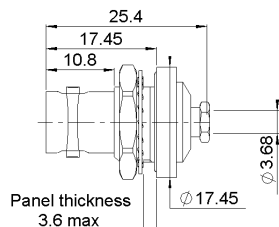

Cable group	Cable group dia.	Part number	Captive center contact	Body material	Finish	Note
RG402	.141"	R141 338 007	no	Non-magnetic bronze	BBR / Gold	Panel sealed

Cable terminals

RIGHT-ANGLE TERMINAL SOLDER TYPE FOR FLEXIBLE CABLES

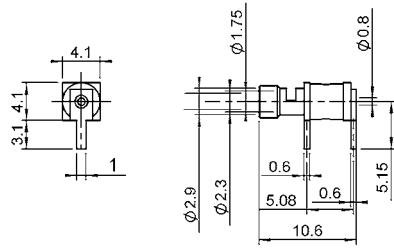

Cable group	Cable group dia.	Part number	Panel drilling	Body material	Finish
RG-174, RG-316, RD-316, RG-179, RD-179	2.6/50+75	R280 220 027	P03	Non-magnetic bronze	Gold over copper

STRAIGHT TERMINAL SOLDER TYPE FOR SEMI-RIGID CABLES

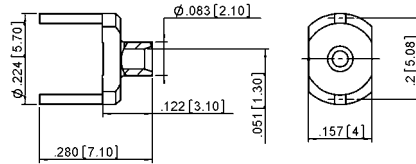

Cable group	Cable group dia.	Part number	Panel drilling	Body material	Finish
RG-174, RG-316, RD-316, RG-179, RD-179	.047	R280 287 107	P04	Non-magnetic bronze	Gold over copper

PRODUCT SPECIFICATION: please refer to the standard range

NON-MAGNETIC CABLE TERMINALS

Our Most Important Connection is with You.™

Non-magnetic cable assemblies

Radiall also offers a standard range of non-magnetic cable assemblies fit to work within the B₀ magnetic field. The cables are not sold separately.

In order to meet our customers specific project requirements, Radiall provides worldwide technical support.

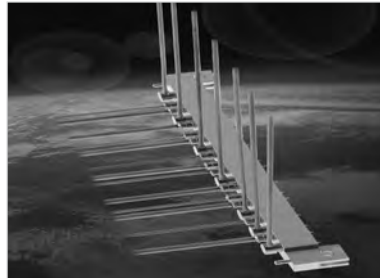

Cable type	Cable group dia.	Part number
RG-178 non-magnetic	2/50/S	C291 140 087
RG-316 non-magnetic	2.6/50/S	C291 170 079
RG-400 non-magnetic	5/50/S	C291 324 079
.085" semi-rigid	.085	C291 851 001
.141" semi-rigid	.141	C291 861 061

Panel drilling

P01

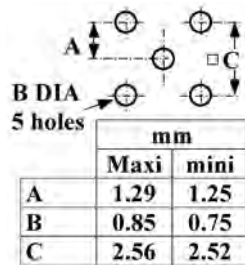

P02

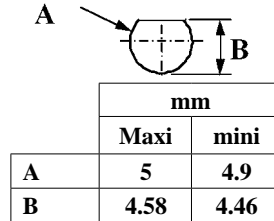

P03

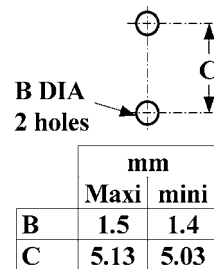

P04

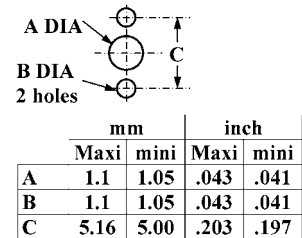

P05

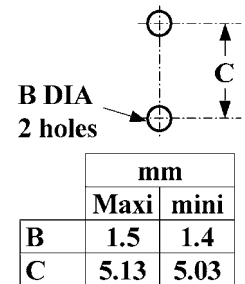

P06

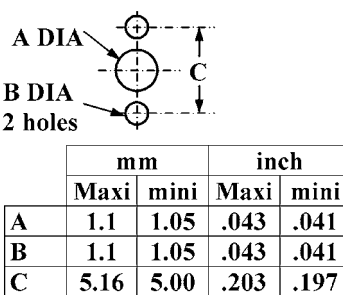

PRODUCT SPECIFICATION: please refer to the standard range

SECTION 16



Adapters
R191 / R192



Contents

Between series 50Ω adapters

Adapters for Radiall propriety interfaces: MC-CARD, MOEBIUS, MQ (MiniQuick), R-MCX, QMA, QN and QRE series (needed to connect to your analyzer)

Finder guide 16-4
Drawing 16-10 to 16-12

Adapters with high frequency and precision connectors: N18 GHZ, PC7, SMA2.4, SMA2.9, SMA3.5 and TNC18 GHZ series

Finder guide 16-5
Drawing 16-13 to 16-15

Adapters with all standard series: 1.0/2.3, 7/16, BMA, BNC, C, HN, MCX, MMBX, MMCX, N, SMA, SMB, SMC, SMP, SSMA, SSMC, TNC and UHF series

Finder guide 16-6 to 16-7
Drawing 16-16 to 16-26

Push-on adapters: N, SMA and TNC series (for time savings during testing activity)

Finder guide 16-5
Drawing 16-27

Between series 75Ω adapters

Adapters with standard series: 1.0/2.3, 1.6/5.6, BNC, MCX and N series

Finder guide 16-4
Drawing 16-28
Panel drilling 16-29

In series 50Ω and 75Ω adapters

Finder guide 16-8 to 16-9

Introduction

Radiall offers an extended range of coaxial connectors and adapters. The following finder guides and drawings will help you to find the between series adapters that fit your needs. Adapters are categorized into one of the following families:

Finder guide

75Ω ADAPTERS

1 st interface		2 nd interface		Part number	Page
Series	Gender	Series	Gender		
BNC	F	N	F	R192 418 000	16-11
			M	R192 421 000	
	M	N	F	R192 419 000	
N	F	BNC	F	R192 418 000	
			M	R192 419 000	
	M		F	R192 421 000	

50Ω ADAPTERS FOR RADIAL PROPRIETARY INTERFACES

1 st interface		2 nd interface		Part number	Page
Series	Gender	Series	Gender		
MC-Card	F	SMA	F	R191 366 091	16-11
	M			R191 366 071	
Moebius	M	SMA	F	R191 857 000	16-12
R-MCX	F	SMA	F	R191 976 020	
			M	R191 977 020	
QLI	F	7/16	M	R191 984 008	
			F	R191 663 000	
			F	R191 665 000	
	M	7/16	M	R191 662 000	
			F	R191 664 000	
			M	R191 792 000	
QMA	F	N	F	R191 793 000	
			M	R191 794 000	
		SMA	F	R191 764 000	
	M		R191 762 000		
	F		R191 913 000		
	M	N	F	R191 912 000	
M			R191 763 000		
M			R191 765 000		
QN	F	7/16	F	R191 911 000	
			M	R191 910 000	
			M	R191 923 000	
	M	N	F	R191 923 000	16-14
				R191 760 010	
				R191 760 000	
QRE	F	SMA	M	R191 759 000	
			F	R191 757 000	
	M	SMA3.5	F	R191 927 L01	
F			R191 946 700		
MMS	M	SMA3.5	F	R191 926 L01	
			F	R191 944 700	
UMP H2	M	SMA	F	R191 975 781	16-14
UMP H3	M	SMA	F	R107 009 901	
				R107 009 903	

Finder guide

50Ω ADAPTERS WITH HIGH FREQUENCY AND PRECISION CONNECTORS

1 st interface		2 nd interface		Part number	Page
Series	Gender	Series	Gender		
N18	F	SMA3.5	F	R191 330 000	16-15
			F	R191 333 000	
			M	R191 326 000	
	F		R191 328 000		
	M		R191 324 000		
PC7	F	BNC	F	R191 015 000	
			M	R191 013 000	
		N	F	R191 027 000	
			M	R191 025 000	
		SMA	F	R191 011 000	
			M	R191 009 000	
	M	SMA3.5	F	R191 012 000	
			M	R191 010 000	
		SMB	F	R191 007 000	
		SMC	F	R191 003 000	
2.4 mm	F	SMA2.9	F	R191 970 091	
			M	R191 970 071	
		SMPM	F	R191 565 000	
			M	R191 564 000	
			F	R191 970 081	
	M	SMA2.9	M	R191 970 061	
			F	R191 563 000	
		SMPM	M	R191 562 000	
			F	R191 970 091	
			M	R191 970 081	
SMA2.9	F	SMA2.4	F	R191 969 002	
			M	R191 968 001	
		SMP	F	R191 959 000	
			M	R191 958 000	
		M	SMA2.4	F	R191 970 071
				M	R191 970 061
	SMP		F	R191 967 002	
			M	R191 966 001	
	SMPM		F	R191 957 000	
			M	R191 956 020	
	SMA3.5	F	MMS	M	R191 975 781
				F	R191 330 000
N18			F	R191 333 000	
			M	R191 328 000	
PC7			F	R191 012 000	
			M	R191 010 000	
QRE			F	R191 946 700	
			M	R191 944 700	
TNC18		F	R191 316 700		
M		N18	F	R191 326 000	
			M	R191 324 000	
		PC7	F	R191 318 700	
	M		R191 314 730		
TNC18	F	SMA	F	R191 314 700	
			M	R191 316 700	
		SMA 3.5	F	R191 318 700	
			M	R191 314 730	

50Ω PUSH-ON ADAPTERS

1 st interface		2 nd interface		Part number	Page
Series	Gender	Series	Gender		
MCX Push-on	F	SMA	M	R191 977 520	16-18
N Push-on	M	N	F	R161 791 500	
TNC Push-on	M	TNC		R143 713 000	
SMA Push-on	M	SMA		R125 792 501	
	F		R125 791 501		

Finder guide

TEST PROBE ADAPTERS

1 st interface		2 nd interface		Part number	Page
Series	Gender	Series	Gender		
SMA	F	MMBX	F	R191 389 800	16-19
		MML H2.5 & H2.0	F	R191 597 800	
		SMA	F	R191 300 800	
		SMB	M	R191 201 800	
		SMP	M	R191 844 800	
		SMP-MAX	F	R191 553 800	

50Ω ADAPTERS WITH ALL STANDARD SERIES

1 st interface		2 nd interface		Part number	Page	
Series	Gender	Series	Gender			
2B4 (Banana plug 4mm)	F	BNC	M	R191 453 000	16-20	
	M		F	R191 455 000		
4.1-9.5	F	4.3-10	M	R191 598 007	16-22	
4.3-10	F	7/16	M	R191 592 007	16-20	
		N		R191 591 007		
	7/16	F	R191 592 017			
	N		R191 591 017			
	M	7/16	F	R191 592 037		16-22
		M	R191 592 027			
7/16	F	4.1-9.5	F	R191 598 007	16-20	
		M	M	R191 592 017		
		4.3-10	F	R191 592 037	16-22	
			M	R191 908 000		
		N	F	R191 723 000	16-21	
		M	R191 720 000			
	M	QLI	F	R191 665 000	16-12	
			M	R191 664 000		
		4.3-10	F	R191 592 007	16-20	
			M	R191 592 027		
HN		F	R191 907 000	16-21		
N	F	R191 722 000				
BMA	F	SMA	F	R191 353 711	16-23	
			M	R191 353 701		
		SMP	M	R191 351 701		
			M	R191 815 110		
		M	SMA	F		R191 352 001
	M			R191 355 001		
			M	R191 354 001		
			M	R191 350 001		
	SMP		F	R191 811 110		
	BNC	F	2B4	M	R191 455 000	16-20
C			M	R191 429 000	16-24	
HN			M	R191 449 000		
MCX			F	R191 477 120	16-25	
N			F	R191 422 000		
			M	R191 424 000		
PC7			M	R191 421 000	16-15	
SMA			M	R191 303 000		
SMB			F	M	R191 215 000	16-25
					5512-7501-000	
			M	F	R191 212 500	
					R191 213 000	
					R191 212 000	

1 st interface		2 nd interface		Part number	Page	
Series	Gender	Series	Gender			
BNC	F	SMC	F	R191 123 000	16-26	
				M		R191 124 000
						R191 120 000
						5510-1501-000
						R191 405 000
		TNC	M	R191 447 000	16-26	
			M	R191 454 000		
		UHF	M	R191 453 000	16-20	
						R191 454 000
		2B4	F	R191 419 000	16-26	
						R191 417 000
		N	F	R191 214 000	16-27	
			M	R191 305 000		
		PC7	-	R191 013 000	16-15	
						R191 301 000
SMA	F	R191 214 000	16-22			
	M	5405-1501-000				
SMB	F	R191 209 000	16-27			
	M	5404-1501-000				
SMC	F	5403-1501-000	16-22			
	M	5402-1501-000				
TNC	F	R191 117 000	16-27			
	M	R191 403 000				
UHF	F	R191 445 000	16-27			
				R191 708 000		
C	F	N	M	R191 703 000	16-28	
				R191 429 000	16-24	
HN	F	BNC	F	R191 933 000	16-28	
		HN	F	R191 933 000		
		N	F	R191 705 000		
MCX	F	7/16	M	R191 907 000	16-21	
		C	M	R191 933 000		
		N	F	R191 705 000		
LC	F	7/16	F	R191 908 000	16-21	
				R191 449 000		
HN	M	BNC	F	R191 449 000	16-24	
		N	F	R191 737 000		
LC	F	N	F	R191 741 000	16-28	
				R191 741 000		
MCX	F	7/16	F	R191 908 000	16-21	
				R191 908 000		
MMCX	F	BNC	F	R191 477 120	16-24	
				R191 477 120		
MMCX	M	SMA	F	R191 388 000	16-28	
				R191 386 000		
MMBX	F	SMA	M	R191 387 107	16-29	
						R191 387 000
MMBX	M	SMA	F	R191 385 000	16-29	
						R191 399 100
MMBX	F	SMA	M	R191 398 020	16-29	
						R191 389 400
MMBX	M	SMA	F	R191 389 300	16-29	
						R191 389 200
MMBX	F	SMA	M	R191 389 100	16-29	
						R191 389 100

Finder guide

50Ω ADAPTERS WITH ALL STANDARD SERIES

1 st interface		2 nd interface		Part number	Page
Series	Gender	Series	Gender		
N	F	4.3-10	M	R191 591 017	16-30
		7/16	F	R191 723 000	16-21
			M	R191 722 000	
		BNC	F	R191 422 000	16-25
				R191 424 000	
		C	F	R191 419 000	16-26
				R191 708 000	
		HN	M	R191 737 000	16-28
				R191 741 000	
		PC7	-	R191 027 000	16-15
		QLI	M	R191 794 000	16-12
		QMA	F	R191 764 000	16-13
				R191 763 000	
		QN	F	R191 760 010	16-14
				R191 760 000	
		SMA	F	R191 759 000	16-30
				R191 334 000	
				R191 332 000	
				R191 331 000	
				R191 381 000	
		SMA	M	R191 327 000	16-30
	R191 377 000				
	R191 327 000				
	SMB	F	R191 239 000	16-31	
			R191 236 000		
	TNC	F	R191 514 000	16-31	
			R191 511 000		
	UHF	M	R191 733 000		
	M	4.3-10	F	R191 591 007	16-20
				R191 720 000	16-21
				R191 721 000	
		BNC	F	R191 421 000	16-25
				R191 417 000	16-26
		C	F	R191 703 000	16-28
		PC7	-	R191 025 000	16-15
		QLI	F	R191 793 000	16-12
				R191 792 000	
		QMA	F	R191 762 000	16-13
				R191 765 000	
		QN	M	R191 757 000	16-14
		SMA	F	R191 329 000	16-31
				R191 325 000	
SMB		M	R191 233 000	16-31	
			R191 513 000		
TNC		F	R191 513 050	16-31	
			R191 731 000		
SMA	F	BMA	F	R191 353 711	16-23
			R191 353 701		
		BMA	M	R191 352 001	16-24
				R191 355 001	
		BNC	M	R191 305 000	16-27
		MC-Card	F	R191 366 091	16-11
				R191 366 071	
		MCX	F	R191 388 000	16-28
				R191 387 107	
		MMBX	F	R191 389 400	16-29
				R191 389 200	
		MMCX	F	R191 399 100	16-29
				R191 398 020	
		Moebius	M	R191 857 000	16-11

1 st interface		2 nd interface		Part number	Page
Series	Gender	Series	Gender		
SMA	F	N	F	R191 334 000	16-30
				R191 332 000	
				R191 331 000	
				R191 381 000	
		N	M	R191 329 000	16-31
				R191 011 000	16-16
		PC7	F	R191 913 000	16-13
		QMA	M	R191 911 000	
		QRE	M	R191 926 L01	16-14
		R-MCX	F	R191 976 020	16-12
				R191 203 007	16-32
		SMB	M	R191 201 007	
				R191 844 002	
		SMP	M	R191 843 001	16-23
				R191 843 421	
				R191 843 401	
				R191 843 429	
		SMP	M	R191 843 409	16-23
				5964-9513-001	
		SMPM	M	5965-9513-000	16-32
		SSMA	F	R191 349 000	
	SSMC	F	5945-9503-000	16-33	
	TNC	F	R191 315 000		16-33
			R191 365 000		
	TNC	M	R191 313 000	16-18	
			R191 318 700		
	TNC18 GHz	F	R191 314 730	16-33	
			R191 314 700		
	M	BMA	M	R191 351 701	16-23
				R191 354 001	16-24
				R191 350 001	
		BNC	F	R191 303 000	16-25
				R191 301 000	16-27
		MCX	F	R191 386 000	16-28
				R191 385 000	
		MMCX	F	R191 389 300	16-29
				R191 389 100	
		N	F	R191 327 000	16-30
				R191 377 000	
	N	M	R191 325 000	16-31	
			R191 009 000	16-16	
	QMA	F	R191 912 000	16-13	
R191 910 000					
QRE	F	R191 927 L01	16-14		
R-MCX	F	R191 977 020	16-12		
		R191 984 008			
SMB	M	R191 200 007	16-33		
SMC	F	R191 374 000			
SMP	F	R191 842 002	16-34		
		R191 841 001			
SSMA	F	R191 347 000	16-34		
SSMC	M	5938-1503-000			
TNC	F	R191 311 000	16-34		
		R191 309 000			

Finder guide

50Ω ADAPTERS WITH ALL STANDARD SERIES

1 st interface		2 nd interface		Part number	Page
Series	Gender	Series	Gender		
SMB	F	BNC	F	R191 215 000	16-25
			M	5512-7501-000	
			F	R191 214 000	
		M	5405-1501-000	16-22	
		N	F	R191 239 000	16-30
		PC7	F	R191 007 000	16-16
	SMA	F	R191 203 007	16-32	
	M	BNC	F	R191 212 500	16-25
			M	R191 213 000	
			F	R191 212 000	16-26
		M	R191 209 000	16-27	
		M	5404-1501-000	16-22	
N		F	R191 236 000	16-30	
SMA	M	R191 233 000	16-31		
	F	R191 201 007	16-32		
	M	R191 200 007	16-33		
SMC	F	BNC	F	R191 123 000	16-26
			M	5403-1501-000	
		PC7	F	R191 003 000	16-16
	SMA	M	R191 374 000	16-33	
	M	BNC	F	R191 120 000	16-26
			M	5510-1501-000	16-22
M		R191 117 000	16-27		
M	M	5402-1501-000	16-22		
SMP	F	BMA	M	R191 811 110	16-24
		SMA	F	R191 844 002	16-32
			M	R191 842 002	16-33
		SMA2.9	F	R191 969 002	16-17
			M	R191 967 002	
	M	BMA	F	R191 815 110	16-23
		SMA	F	R191 843 001	16-32
			M	R191 843 429	16-23
			M	R191 843 409	
		SMA2.9	F	R191 841 001	16-34
			M	R191 968 001	16-17
		SMPM	M	R191 966 001	
SMPM	M	R191 570 100	16-34		

1 st interface		2 nd interface		Part number	Page
Series	Gender	Series	Gender		
SMMPM	F	2.4 mm	F	R191 565 000	16-34
			M	R191 563 000	
		SMA 2.9	F	R191 959 000	16-17
			M	R191 957 000	
	M	2.4 mm	F	R191 564 000	16-35
			M	R191 562 000	
		SMA	F	5964-9513-001	
			F	5965-9513-000	
		SMA 2.9	F	R191 958 000	
			M	R191 958 020	
	SMP	M	R191 956 020		
	SSMA	F	SMA	F	R191 570 100
M				R191 349 000	16-32
SSMC	F	SMA	M	R191 347 000	16-34
			M	F	5945-9503-000
TNC	F	BNC	M	5938-1503-000	16-34
			F	R191 403 000	16-27
		N	M	R191 514 000	16-30
			M	R191 513 000	16-31
		M	R191 513 050		
		SMA	F	R191 315 000	16-33
	M		R191 365 000		
	M	BNC	F	R191 311 000	16-34
			M	R191 405 000	16-26
		SMA	N	F	R191 511 000
	F		R191 313 000	16-33	
	UHF	F	BNC	M	R191 309 000
F				R191 445 000	16-27
N			M	R191 731 000	16-31
M		BNC	F	R191 447 000	16-26
			N	F	R191 733 000
		SMA	M	R191 309 000	16-34

Finder guide

50Ω AND 75Ω IN SERIES ADAPTERS (for reference only)

In Series Adaptors	Part Number	Gender (Male-Female)				Type					Function								
		Side 1	Side 2	Side 3	Side 4	Str.	R/A	U	T	X	Bulkhead	Sealed		Panel Isolated	Flange	Press-In	Locked on Panel	Hermetic	
												Panel	Inside Line						
7/16	R185 703 000	M	M			X													
	R185 705 000	F	F			X													
	R185 707 000	M	F			X													
	R185 710 000	F	F			X													
	R185 730 020	F	F			X					X	X			X				
2.4 mm	R327 703 000	M	M			X					X	X							
	R327 704 000	M	F			X													
	R327 705 000	F	F			X													
	R327 771 000	M	F				X												
4.1-9.5	R170 703 007	M	M			X													
	R141 703 000	M	M			X													
BNC	R141 704 000	F	F			X													
	R141 710 000	F	F			X													
	R141 717 000	F	F			X								X	X				
	R141 720 000	F	F			X					X								
	R141 723 000	F	F			X					X			X					
	R141 723 161	F	F			X					X			X					
	R141 730 000	F	F			X					X	X							
	R141 753 000	F	F			X					X	X						X	
	R141 770 000	M	F				X												
	R141 780 000	F	F	M					X										
	R141 782 000	F	F	F					X										
	R141 789 000	F	M	F					X										
	R141 799 000	F	F		M					X									
	BNC 75 Ω	R142 703 000	M	M			X												
R142 704 000		F	F			X													
R142 710 000		F	F			X									X				
R142 720 000		F	F			X					X								
R142 723 000		F	F			X					X			X					
R142 770 000		M	F				X												
R142 780 000		F	F	M															
R142 782 000		F	F	F															
R142 789 000	M	F	F																
BNC 75 HDTV	R142 703 703	M	M			X					X								
BNC HT	R142 720 700	F	F			X					X								
	R316 704 000	F	F			X					X	X	X						
C	R316 754 000	F	F			X													
	R166 705 000	F	F			X													
DT-F	R166 770 000	M	F				X												
	R166 753 000	F	F			X					X	X						X	
HN	R139 705 023	F	F			X													
	R176 754 000	F	F			X					X	X	X					X	
	R176 754 150	F	F			X					X	X							
MCC2	R176 770 000	M	F				X												
	R199 001 703	M	M			X										X			
	R199 001 713	M	M			X													
	R199 001 733	M	M			X											X		
MCX	R113 704 000	F	F			X													
MMCX	R110 704 103	F	F			X					X								
MMS	R209 703 070	M	M			X													
MMT	R210 703 507	F	F Slide on			X													
N	R161 703 000	M	M			X													
	R161 705 000	F	F			X													
	R161 715 000	F	F			X									X				
	R161 730 000	F	F			X					X	X							
	R161 753 000	F	F			X					X	X	X					X	
	R161 771 000	M	F				X												
	R161 780 000	F	F	M															
	R161 782 000	F	F	F															
N18 GHz	R161 791 500	F	F Slide on			X													
	R161 791 530	M	F			X													
	R163 703 001	M	M			X													
	R163 705 001	F	F			X													
N75 Ω	R163 708 001	M	F			X													
	R162 703 000	M	M			X													
QMA	R162 705 000	F	F			X													
	R123 703 000	M	M			X													
	R123 704 000	M	F			X													
QN	R123 705 000	F	F			X													
	R164 705 000	F	F			X													
	R164 708 000	M	F			X													

Note: drawings can be found in the corresponding series' section

ADAPTERS

Finder guide

50Ω AND 75Ω IN SERIES ADAPTERS (for reference only)

In Series Adaptors	Part Number	Gender (Male-Female)				Type					Function								
		Side 1	Side 2	Side 3	Side 4	Str.	R/A	U	T	X	Bulkhead	Sealed		Panel Isolated	Flange	Press-In	Locked on Panel	Hermetic	
												Panel	Inside Line						
SHV	R317 720 000	M	M			X					X								
	R125 703 000	M	M			X													
SMA	R125 703 001	M	M			X													
	R125 704 000	M	F			X													
	R125 704 001	M	F			X													
	R125 705 000	F	F			X													
	R125 705 001	F	F			X													
	R125 720 000	F	F			X					X								
	R125 720 001	F	F			X					X								
	R125 753 000	F	F			X					X	X	X					X	
	R125 753 001	F	F			X					X	X	X					X	
	R125 771 000	M	F				X												
	R125 771 001	M	F				X												
	R125 780 000	F	F	M					X										
	R125 780 001	F	F	M					X										
	R125 781 000	F	F	F					X										
	R 125 781 001	F	F	F					X										
	R125 791 501	F	M Slide on			X													
	R125 792 501	F	F Slide on			X													
	SMA 2.9	R127 703 001	M	M			X												
R127 704 001		M	F			X													
R127 705 001		F	F			X													
R127 712 001		F	F			X													
R127 732 100		F	F			X					X	X		X					
R127 753 000		F	F			X					X	X	X					X	
R127 870 001		F	F			X													
R127 871 001		M	M			X													
SMB	R114 703 000	M	M			X													
	R114 704 000	F	F			X													
	R114 720 000	M	M			X					X								
	R114 753 000	M	M			X					X	X	X					X	
	R114 780 000	M	M	F															
	R114 781 000	M	M	M															
	5207-1501-000	M	M	M				X											
	5222-1501-000	M	M			X					X								
	5213-1501-000	M	M			X													
	5215-1501-000	M	M	F				X											
SMC	5216-1501-000	F	F			X													
	5208-1501-000	F	F	F				X											
SSMA	R112 720 000	M	M			X					X								
	R112 780 000	M	M	F				X											
SSMB	R121 703 000	M	M			X													
	R121 705 000	F	F			X													
SSMC	R121 705 001	F	F			X													
	7222-1501-600	M	M			X					X								
TNC	7122-1502-000	M	M			X					X								
	R143 703 000	M	M			X													
	R143 704 000	F	F			X													
	R143 710 000	F	F			X									X				
	R143 713 000	F	M Slide on			X									X				
	R143 713 200	M	F			X										X			
	R143 720 000	F	F			X					X								
	R143 753 000	F	F			X					X	X	X					X	
	R143 770 000	M	F					X											
	R143 780 000	F	F	M				X											
TNC18	R143 782 000	F	F	F				X											
	R143 703 700	M	M			X													
	R143 704 700	F	F			X													
	R143 705 700	M	F			X													
	R143 710 700	F	F			X								X					
UHF	R143 730 700	F	F			X					X	X							
	R155 705 000	F	F			X													

Note: drawings can be found in the corresponding series' section

75 ohms adapters

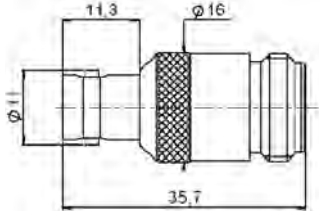

Part number	Interface
R192 418 000	BNC female - N female

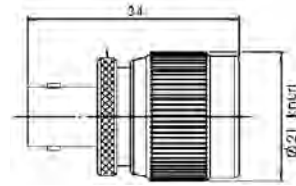

Part number	Interface
R192 421 000	BNC female - N male

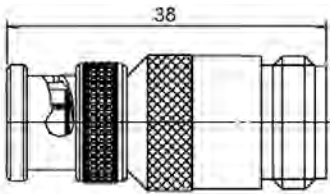

Part number	Interface
R192 419 000	BNC male - N female

Radiall proprietary interface adapters

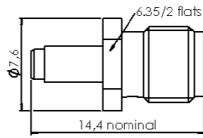

Part number	Interface
R191 366 091	MC-Card female - SMA female

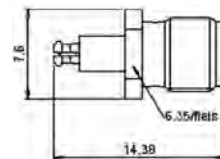

Part number	Interface
R191 366 071	MC-Card male - SMA female

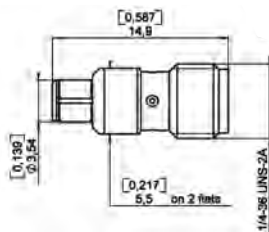

Part number	Interface
R191 857 000	Moebius male - SMA female

Radiall proprietary interface adapters

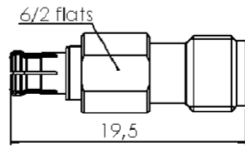

Part number	Interface
R191 976 020	R-MCX female - SMA female

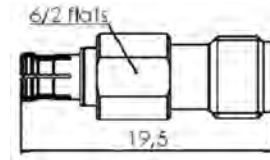

Part number	Interface
R191 977 020	R-MCX female - SMA male

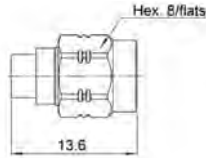

Part number	Interface
R191 984 008	R-MCX male - SMA male

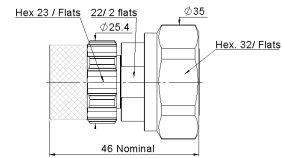

Part number	Interface
R191 663 000	QLI female - 7/16 male

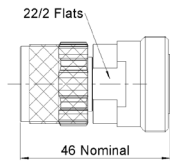

Part number	Interface
R191 665 000	QLI female - 7/16 female

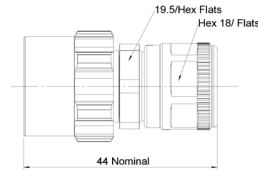

Part number	Interface
R191 793 000	QLI female - N male

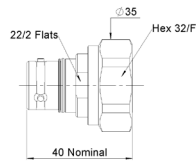

Part number	Interface
R191 662 000	QLI male - 7/16 male

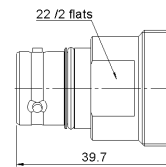

Part number	Interface
R191 664 000	QLI male - 7/16 female

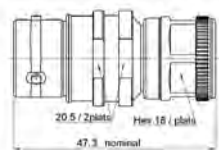

Part number	Interface
R191 792 000	QLI male - N male

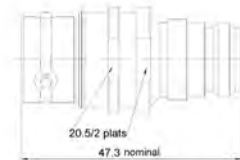

Part number	Interface
R191 794 000	QLI male - N female

Radial proprietary interface adapters

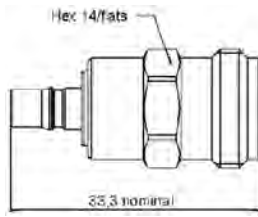

Part number	Interface
R191 764 000	QMA female - N female

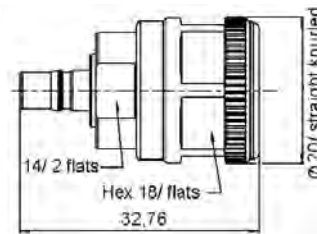

Part number	Interface
R191 762 000	QMA female - N male

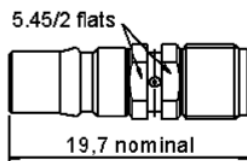

Part number	Interface
R191 913 000	QMA female - SMA female

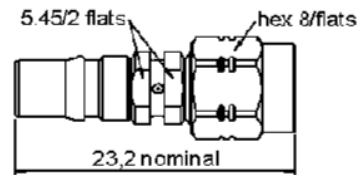

Part number	Interface
R191 912 000	QMA female - SMA male

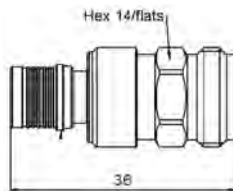

Part number	Interface
R191 763 000	QMA male - N female

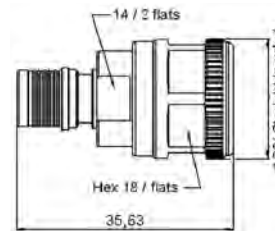

Part number	Interface
R191 765 000	QMA male - N male

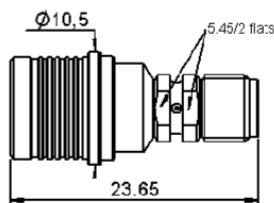

Part number	Interface
R191 911 000	QMA female - SMA female

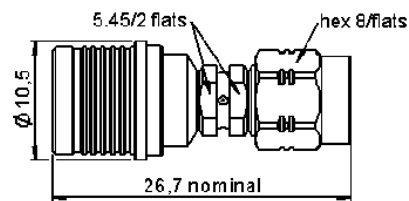

Part number	Interface
R191 910 000	QMA male - SMA male

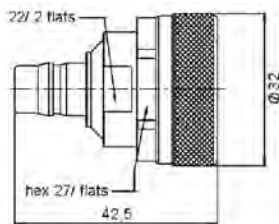

Part number	Interface
R191 923 000	QN female - 7/16 male

Radial proprietary interface adapters

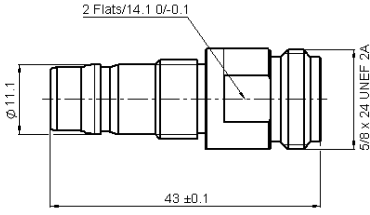

Part number	Interface
R191 760 010	QN female - N female

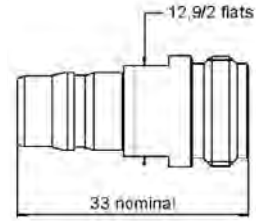

Part number	Interface
R191 760 000	QN female - N female

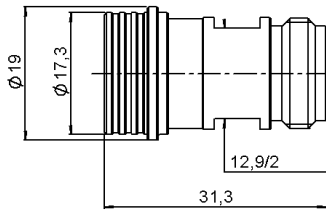

Part number	Interface
R191 759 000	QN male - N female

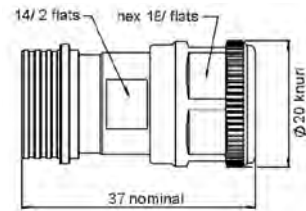

Part number	Interface
R191 757 000	QN male - N male

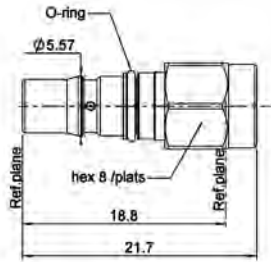

Part number	Interface
R191 927 L01	QRE female - SMA male

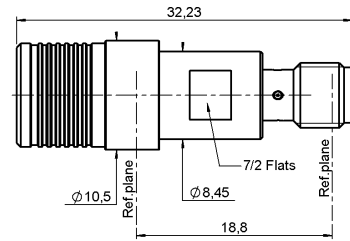

Part number	Interface
R191 926 L01	QRE male - SMA female

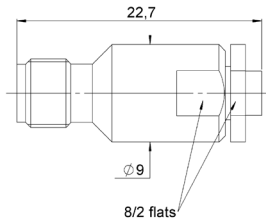

Part number	Interface
R191 975 781	MMS male - SMA 3.5 female

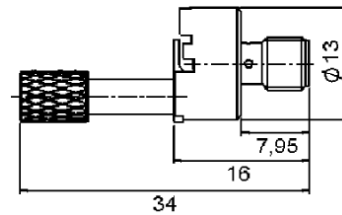

Part number	Interface
R107 009 901	UMP H2 - SMA female

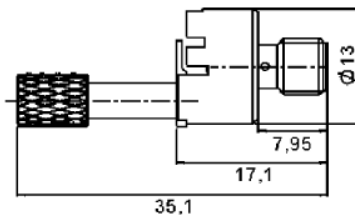

Part number	Interface
R107 009 903	UMP H3 - SMA female

High frequency and precision connector adapters

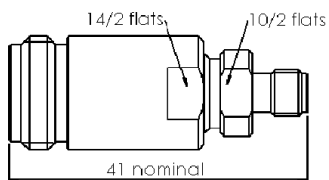

Part number	Interface
R191 330 000	N18 female - SMA3.5 female

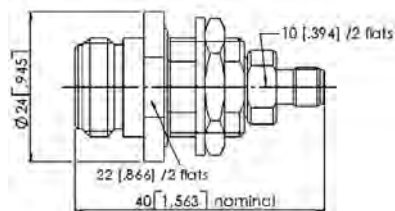

Part number	Interface	Panel drilling
R191 333 000	N18 female - SMA3.5 female	P11

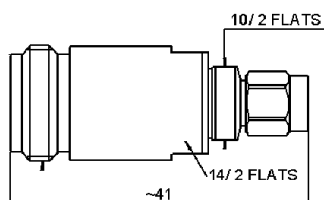

Part number	Interface
R191 326 000	N18 female - SMA3.5 male

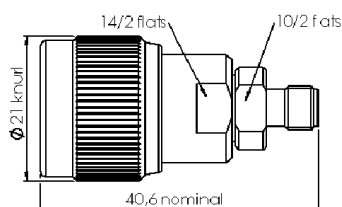

Part number	Interface
R191 328 000	N18 male - SMA3.5 female

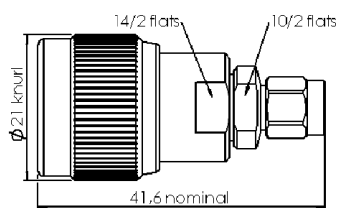

Part number	Interface
R191 324 000	N18 male - SMA3.5 male

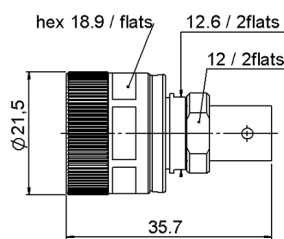

Part number	Interface
R191 015 000	PC7 - BNC female

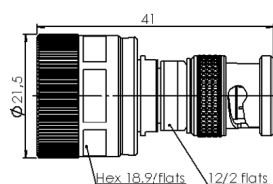

Part number	Interface
R191 013 000	PC7 - BNC male

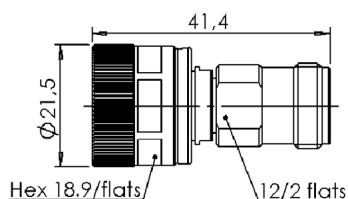

Part number	Interface
R191 027 000	PC7 - N female

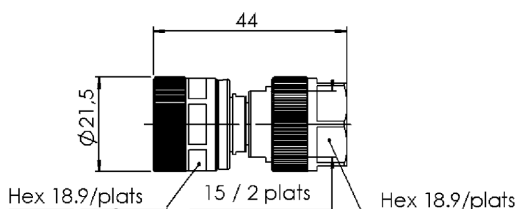

Part number	Interface
R191 025 000	PC7 - N male

ADAPTERS 50Ω

High frequency and precision connector adapters

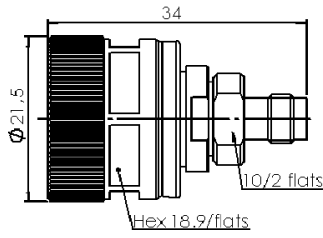

Part number	Interface
R191 011 000	PC7 - SMA female

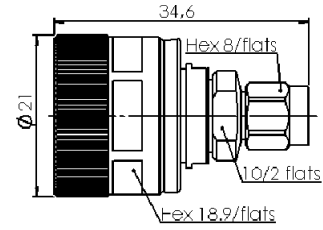

Part number	Interface
R191 009 000	PC7 - SMA male

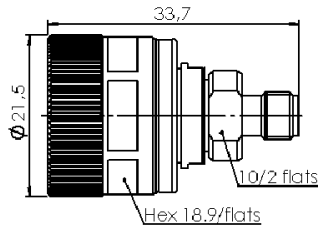

Part number	Interface
R191 012 000	PC7 - SMA3.5 female

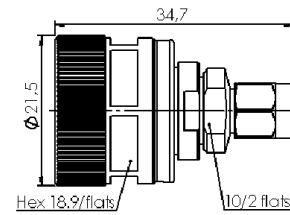

Part number	Interface
R191 010 000	PC7 - SMA3.5 male

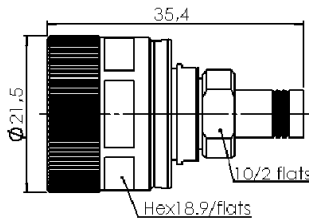

Part number	Interface
R191 007 000	PC7 - SMB female

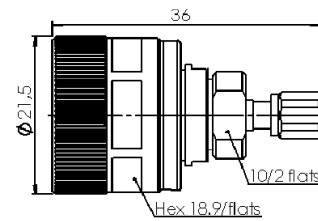

Part number	Interface
R191 003 000	PC7 - SMC female

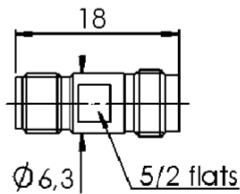

Part number	Interface
R191 970 091	SMA2.4 female - SMA2.9 female

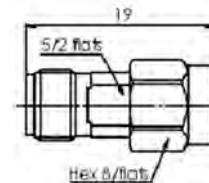

Part number	Interface
R191 970 071	SMA2.4 female - SMA2.9 male

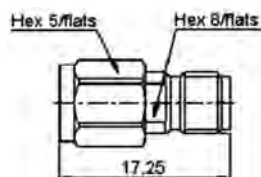

Part number	Interface
R191 970 081	SMA2.4 male - SMA2.9 female

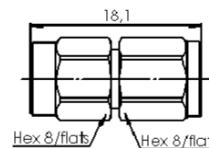

Part number	Interface
R191 970 061	SMA2.4 male - SMA2.9 male

High frequency and precision connector adapters

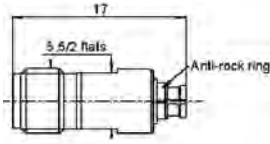

Part number	Interface
R191 969 002	SMA2.9 female - SMP female

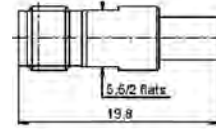

Part number	Interface
R191 968 001	SMA2.9 female - SMP male

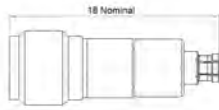

Part number	Interface
R191 959 000	SMA2.9 female - SMPM female

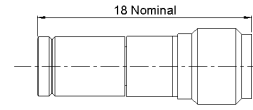

Part number	Interface
R191 958 000	SMA2.9 female - SMPM male

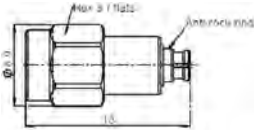

Part number	Interface
R191 967 002	SMA2.9 male - SMP female

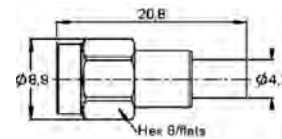

Part number	Interface
R191 966 001	SMA2.9 male - SMP male

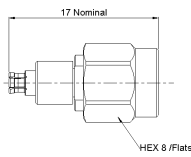

Part number	Interface
R191 957 000	SMA2.9 male - SMPM female

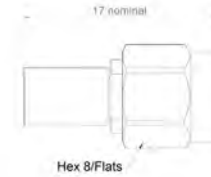

Part number	Interface
R191 956 020	SMA2.9 male - SMPM male

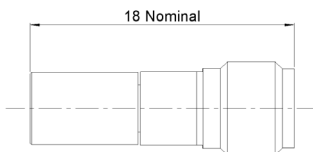

Part number	Interface
R191 958 020	SMA2.9 male - SMPM male

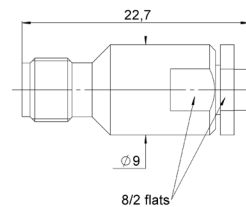

Part number	Interface
R191 975 781	SMA3.5 female - MMS male

ADAPTERS 50Ω

High frequency and precision connector adapters

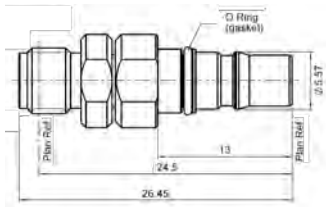

Part number	Interface
R191 946 700	SMA3.5 female - QRE male



Part number	Interface
R191 944 700	SMA3.5 female - QRE male

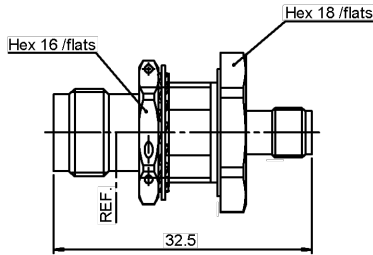

Part number	Interface	Panel drilling
R191 316 700	TNC18 female - SMA3.5 female	P04

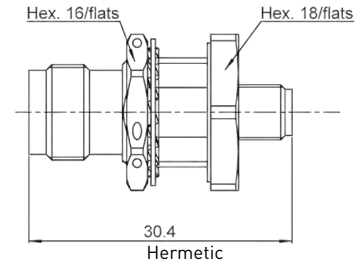

Part number	Interface	Panel drilling
R191 318 700	TNC18 female - SMA female	P04

Push - on adapters

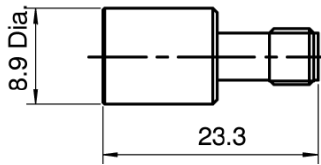

Part number	Interface
R125 791 501	SMA Push-on male - SMA female

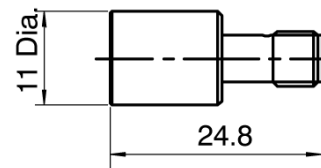

Part number	Interface
R125 792 501	SMA Push-on female - SMA female

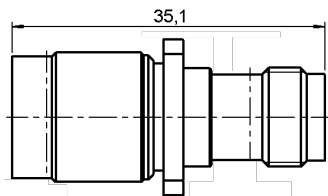

Part number	Interface	Panel drilling
R143 713 000	TNC Push-on male - TNC female	P02

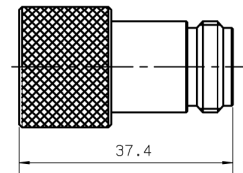

Part number	Interface
R161 791 500	N Push-on male - N female

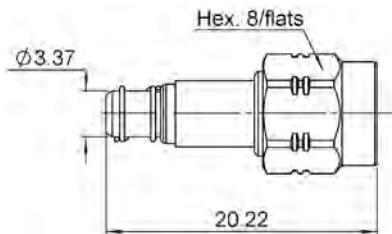

Part number	Interface
R191 977 520	MCX Push-on female - SMA male

Test probe adapters

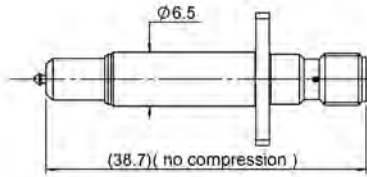

Part number	Interface
R191 389 800	SMA female - MMBX female

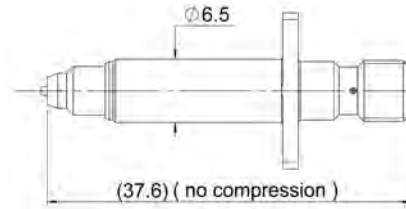

Part number	Interface
R191 597 800	SMA female - MML H2.5 & H2.0 female

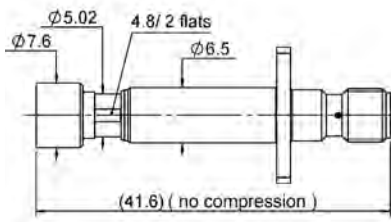

Part number	Interface
R191 300 800	SMA female - SMA female

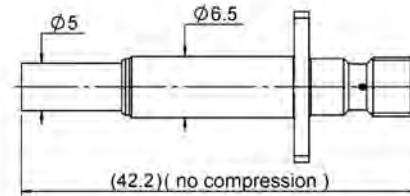

Part number	Interface
R191 201 800	SMA female - SMB male

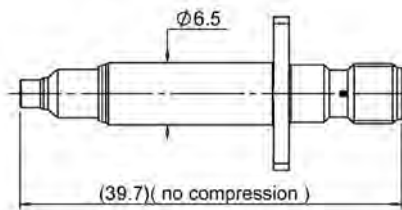

Part number	Interface
R191 844 800	SMA female - SMP female

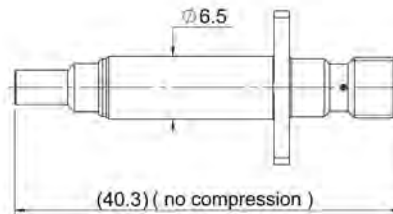

Part number	Interface
R191 553 800	SMA female - SMP-MAX female

ADAPTERS 50Ω

Standard series adapters

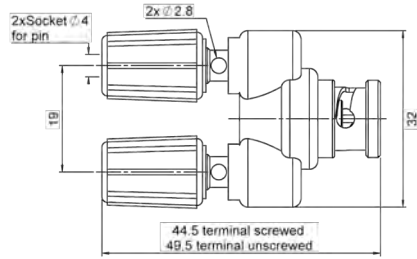

Part number	Interface
R191 453 000	2B4 female - BNC male

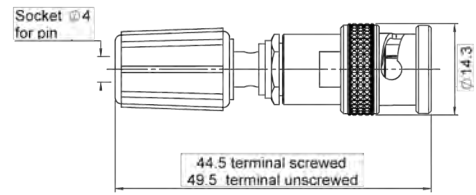

Part number	Interface
R191 454 000	2B4 female - BNC male

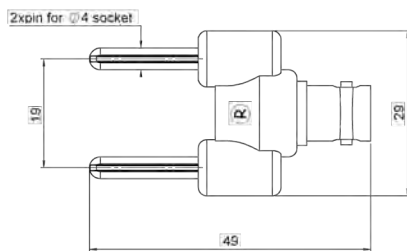

Part number	Interface
R191 455 000	2B4 male - BNC female

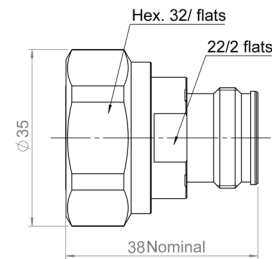

Part number	Interface
R191 592 007	4.3-10 female - 7/16 male

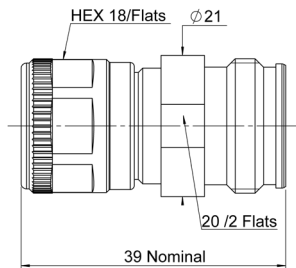

Part number	Interface
R191 591 007	4.3-10 female - N male

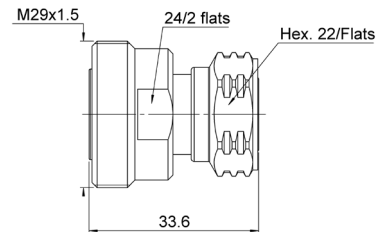

Part number	Interface
R191 592 017	4.3-10 male - 7/16 female

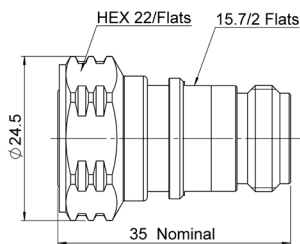

Part number	Interface
R191 591 017	4.3-10 male - N female

Standard series adapters

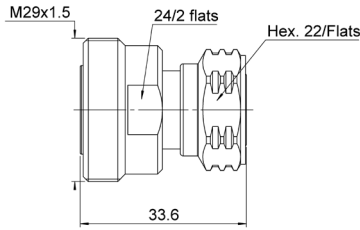

Part number	Interface
R191 592 017	7/16 female - 4.3-10 male

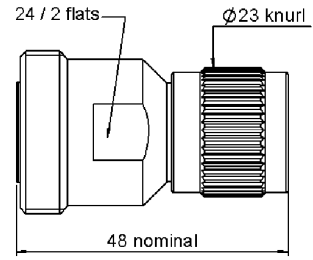

Part number	Interface
R191 908 000	7/16 female - HN male

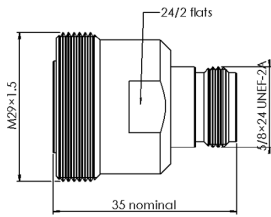

Part number	Interface
R191 723 000	7/16 female - N female

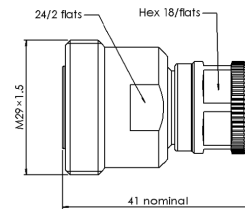

Part number	Interface
R191 720 000	7/16 female - N male

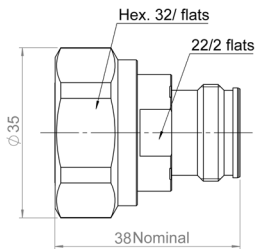

Part number	Interface
R191 592 007	7/16 male - 4.3-10 female

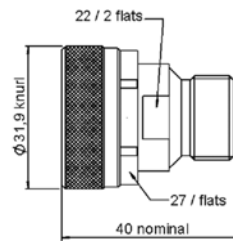

Part number	Interface
R191 907 000	7/16 male - HN female

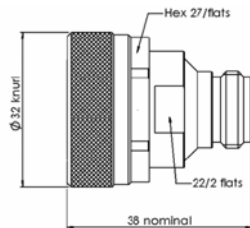

Part number	Interface
R191 722 000	7/16 male - N female

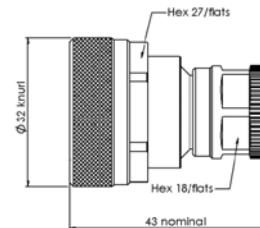

Part number	Interface
R191 721 000	7/16 male - N male

Standard series adapters

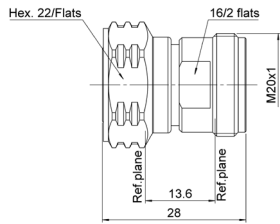

Part number	Interface
R191 598 007	4.3-10 male - 4.1-9.5 female

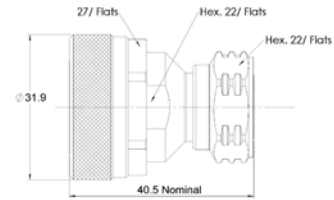

Part number	Interface
R191 592 027	4.3-10 male - 7/16 male

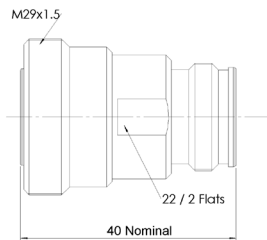

Part number	Interface
R191 592 037	4.3-10 male - 4.1-9.5 female

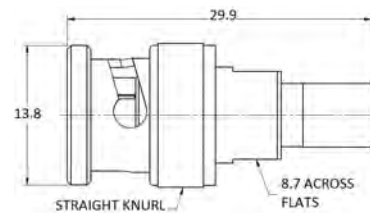

Part number	Interface
5405-1501-000	BNC male - SMB female

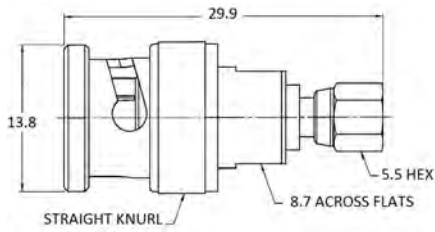

Part number	Interface
5403-1501-000	BNC male - SMC female

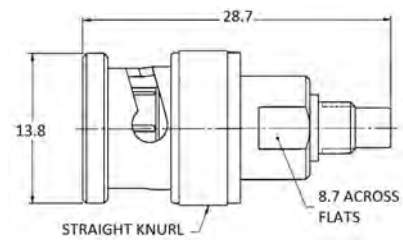

Part number	Interface
5402-1501-000	BNC male - SMC female

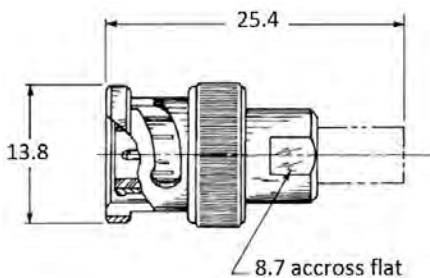

Part number	Interface
5404-1501-000	BNC male - SMB male

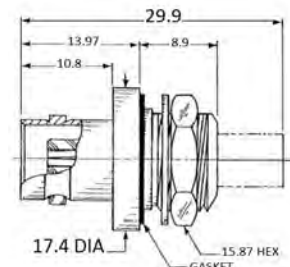

Part number	Interface
5510-1501-000	BNC male - SMB female

Standard series adapters

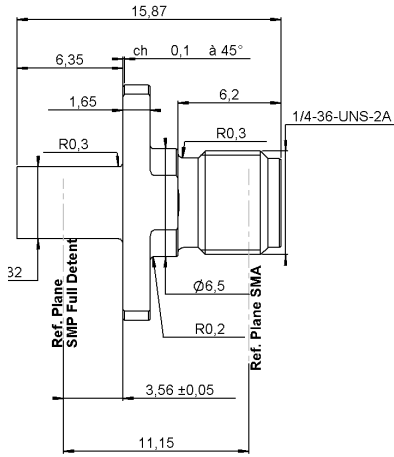

Part number	Interface
R191 843 429	SMA female - SMP male

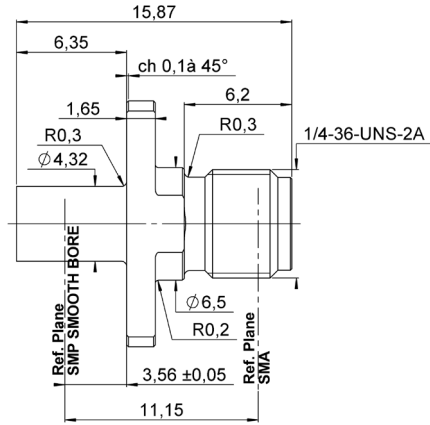

Part number	Interface
R191 843 409	SMA female - SMP male

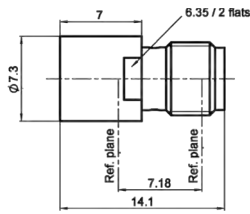

Part number	Interface
R191 353 711	BMA female - SMA female

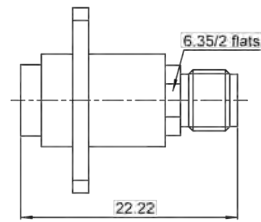

Part number	Interface	Panel drilling
R191 353 701	BMA female - SMA female	P12

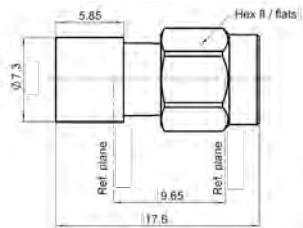

Part number	Interface
R191 351 701	BMA female - SMA male

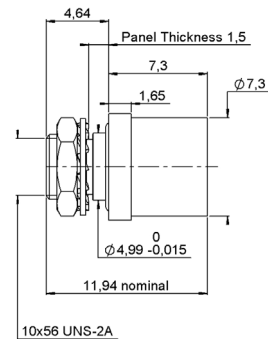

Part number	Interface
R191 815 110	BMA female - SMP male

Standard series adapters

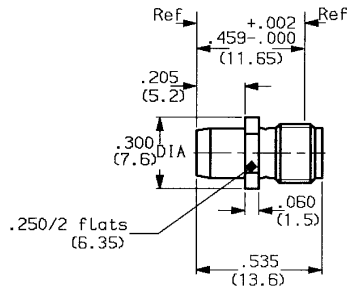

Part number	Interface
R191 352 001	BMA male - SMA female

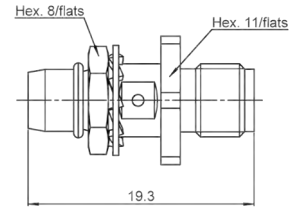

Part number	Interface	Panel drilling
R191 355 001	BMA male - SMA female	P03

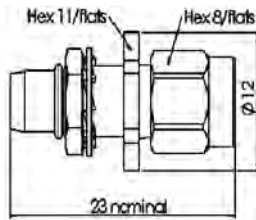

Part number	Interface	Panel drilling
R191 354 001	BMA male - SMA male	P03

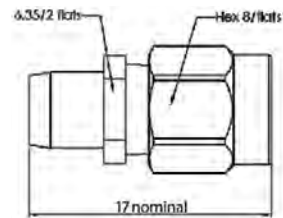

Part number	Interface
R191 350 001	BMA male - SMA male

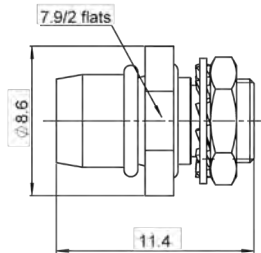

Part number	Interface	Panel drilling
R191 811 110	BMA male - SMP female	P13

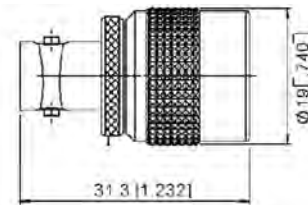

Part number	Interface
R191 429 000	BNC female - C male

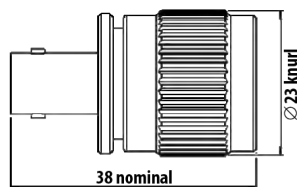

Part number	Interface
R191 449 000	BNC female - HN male

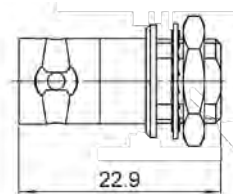

Part number	Interface	Panel drilling
R191 477 120	BNC female - MCX female	P10

Standard series adapters

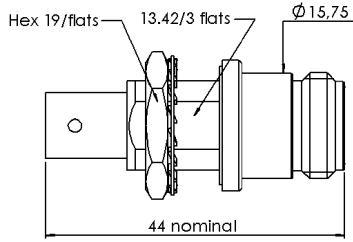

Part number	Interface	Panel drilling
R191 422 000	BNC female - N female	P11

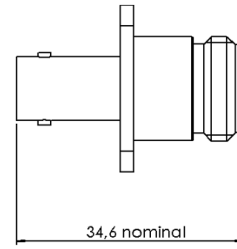

Part number	Interface	Panel drilling
R191 424 000	BNC female - N female	P01

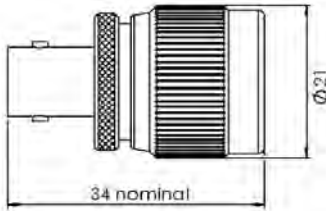

Part number	Interface
R191 421 000	BNC female - N male

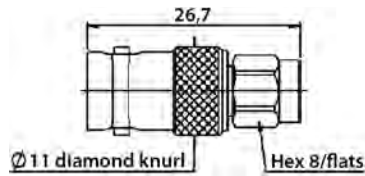

Part number	Interface
R191 303 000	BNC female - SMA male

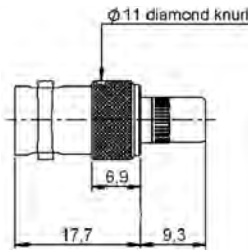

Part number	Interface
R191 215 000	BNC female - SMB female

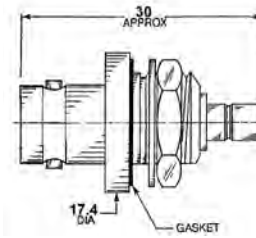

Part number	Interface	Panel drilling
5512-7501-000	BNC female - SMB male	P17

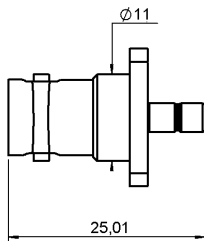

Part number	Interface	Panel drilling
R191 212 500	BNC female - SMB male	P14

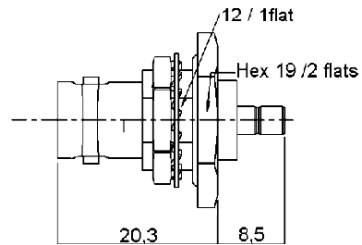

Part number	Interface	Panel drilling
R191 213 000	BNC female - SMB male	P04

Standard series adapters

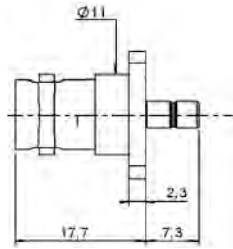

Part number	Interface	Panel drilling
R191 212 000	BNC female - SMB male	P02

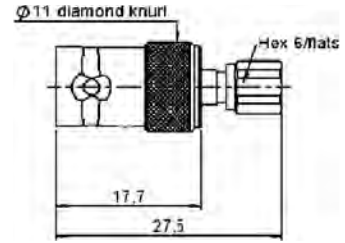

Part number	Interface	Panel drilling
R191 123 000	BNC female - SMC female	

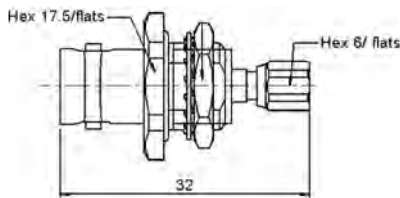

Part number	Interface	Panel drilling
R191 124 000	BNC female - SMC female	P06

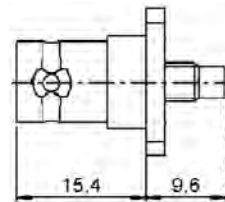

Part number	Interface	Panel drilling
R191 120 000	BNC female - SMC male	P02

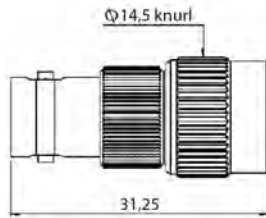

Part number	Interface	Panel drilling
R191 405 000	BNC female - TNC male	

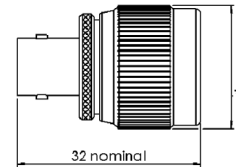

Part number	Interface	Panel drilling
R191 447 000	BNC female - UHF male	

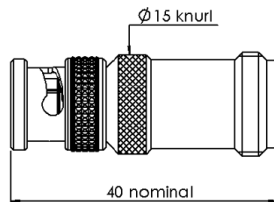

Part number	Interface	Panel drilling
R191 419 000	BNC male - N female	

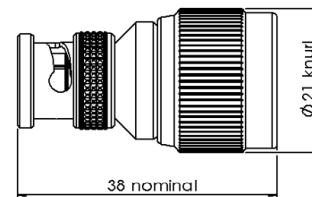

Part number	Interface	Panel drilling
R191 417 000	BNC male - N male	

Standard series adapters

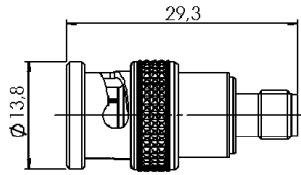

Part number	Interface
R191 305 000	BNC male - SMA female

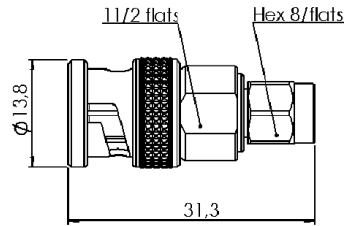

Part number	Interface
R191 301 000	BNC male - SMA male

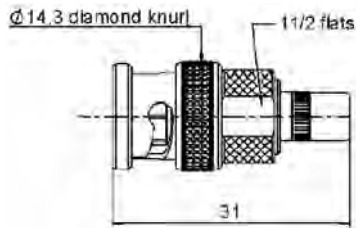

Part number	Interface
R191 214 000	BNC male - SMB female

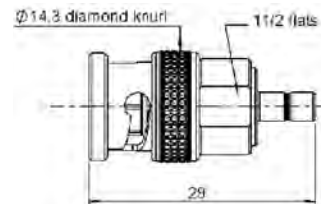

Part number	Interface
R191 209 000	BNC male - SMB male

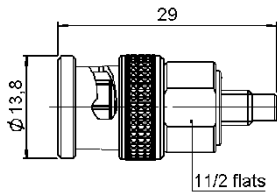

Part number	Interface
R191 117 000	BNC male - SMC male

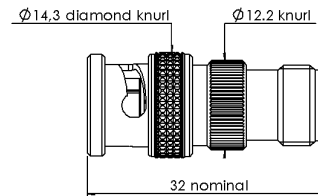

Part number	Interface
R191 403 000	BNC male - TNC female

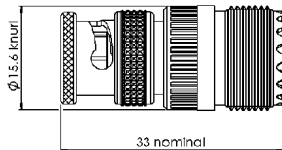

Part number	Interface
R191 445 000	BNC male - UHF female

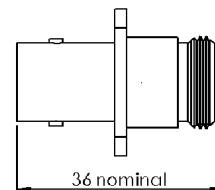

Part number	Interface	Panel drilling
R191 708 000	C female - N female	P01

Standard series adapters

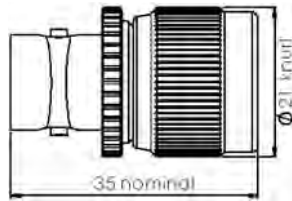

Part number	Interface
R191 703 000	C female - N male

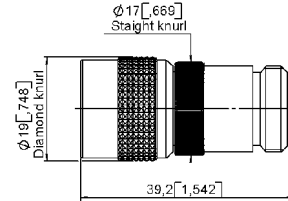

Part number	Interface
R191 705 000	C male - N female

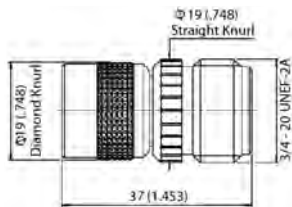

Part number	Interface
R191 933 000	C male - HN female

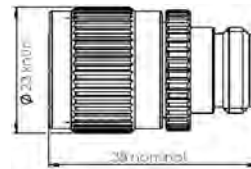

Part number	Interface
R191 737 000	HN male - N female

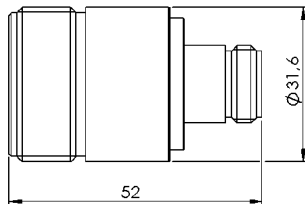

Part number	Interface
R191 741 000	LC female - N female

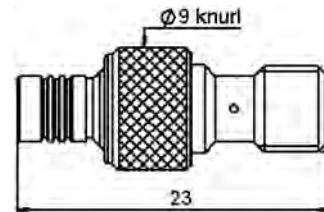

Part number	Interface
R191 388 000	MCX female - SMA female

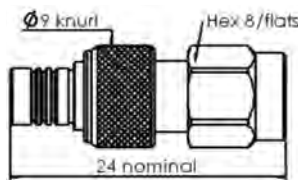

Part number	Interface
R191 386 000	MCX female - SMA male

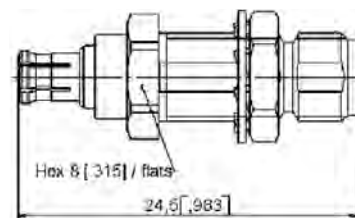

Part number	Interface	Panel drilling
R191 387 107	MCX male - SMA female	P07

Standard series adapters



Part number	Interface
R191 387 000	MCX male - SMA female

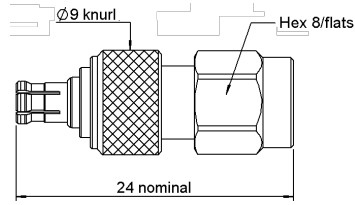

Part number	Interface
R191 385 000	MCX male - SMA male

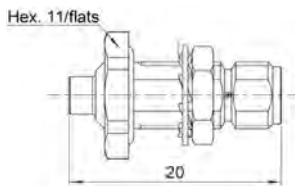

Part number	Interface	Panel drilling
R191 399 100	MMCX female - SMA female	P07

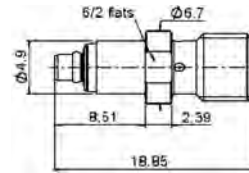

Part number	Interface
R191 398 020	MMCX male - SMA female

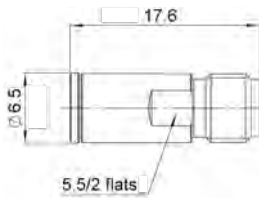

Part number	Interface
R191 389 400	MMBX female - SMA female

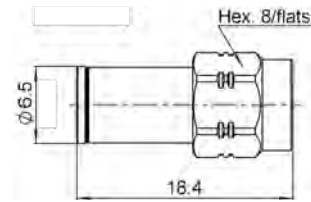

Part number	Interface
R191 389 300	MMBX female - SMA male

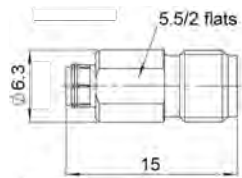

Part number	Interface
R191 389 200	MMBX male - SMA female

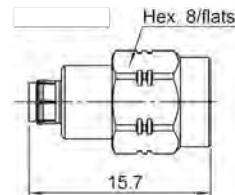

Part number	Interface
R191 389 100	MMBX male - SMA male

Standard series adapters

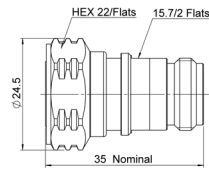

Part number	Interface
R191 591 017	N female- 4.3-10 male

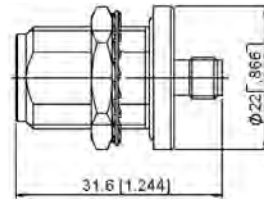

Part number	Interface	Panel drilling
R191 332 000	N female - SMA female	P05

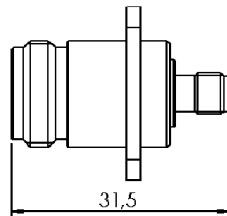

Part number	Interface	Panel drilling
R191 381 000	N female - SMA female	P01

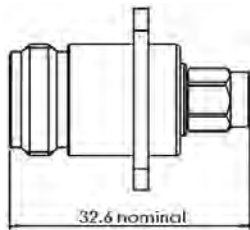

Part number	Interface	Panel drilling
R191 377 000	N female - SMA male	P01

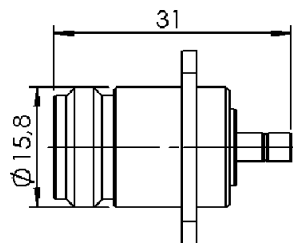

Part number	Interface	Panel drilling
R191 236 000	N female - SMB male	P01

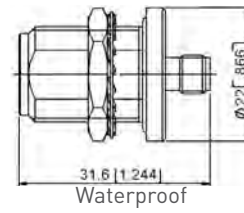

Part number	Interface	Panel drilling
R191 334 000	N female - SMA female	P05

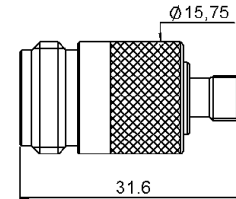

Part number	Interface
R191 331 000	N female - SMA female

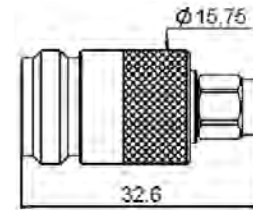

Part number	Interface
R191 327 000	N female - SMA male

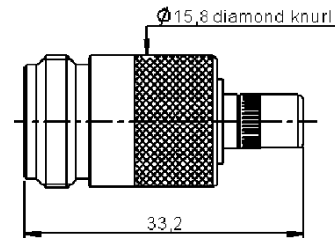

Part number	Interface
R191 239 000	N female - SMB female

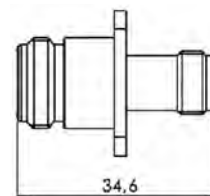

Part number	Interface	Panel drilling
R191 514 000	N female - TNC female	P01

Standard series adapters

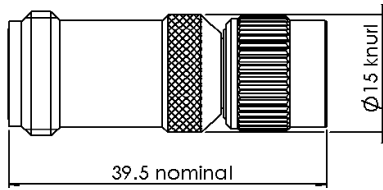

Part number	Interface
R191 511 000	N female - TNC male

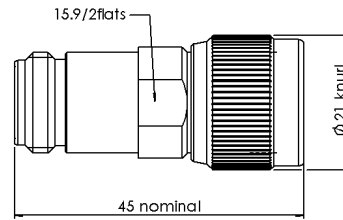

Part number	Interface
R191 733 000	N female - UHF male

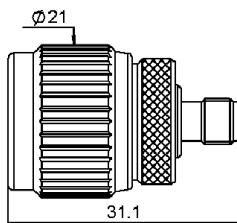

Part number	Interface
R191 329 000	N male - SMA female

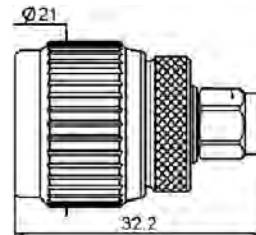

Part number	Interface
R191 325 000	N male - SMA male

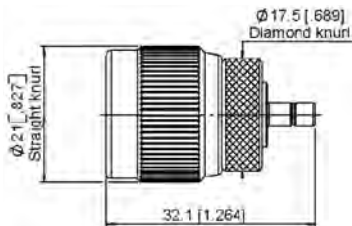

Part number	Interface
R191 233 000	N male - SMB male

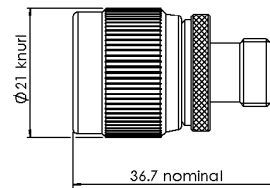

Part number	Interface
R191 513 000	N male - TNC female

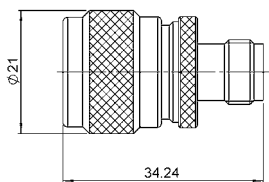

Part number	Interface
R191 513 050	N male - TNC female

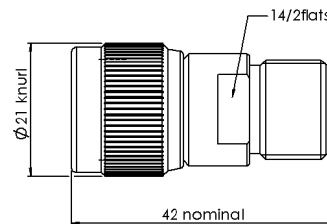

Part number	Interface
R191 731 000	N male - UHF female

Standard series adapters

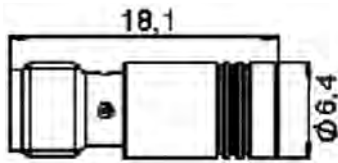

Part number	Interface
R191 203 007	SMA female - SMB female

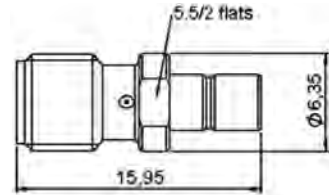

Part number	Interface
R191 201 007	SMA female - SMB male

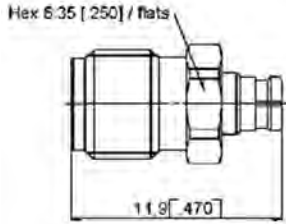

Part number	Interface
R191 844 002	SMA female - SMP female

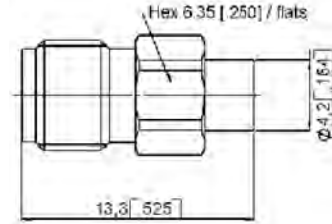

Part number	Interface
R191 843 001	SMA female - SMP male

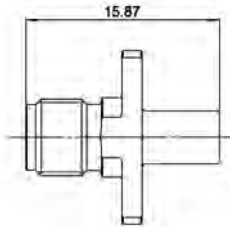

SMP full detent

Part number	Interface	Panel drilling
R191 843 421	SMA female - SMP male	P15

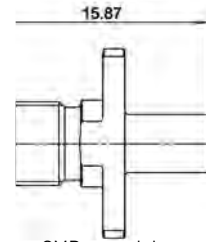

SMP smooth bore

Part number	Interface	Panel drilling
R191 843 401	SMA female - SMP male	P15

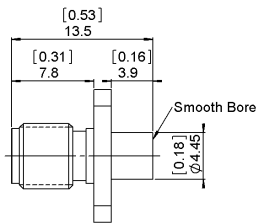

Part number	Interface	Panel drilling
5964-9513-001	SMA female - SMPM male	P15

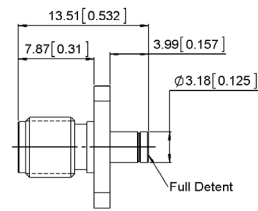

Part number	Interface	Panel drilling
5965-9513-000	SMA female - SMPM male	P15

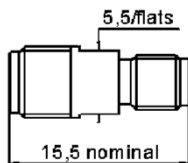

Part number	Interface
R191 349 000	SMA female - SSMA female

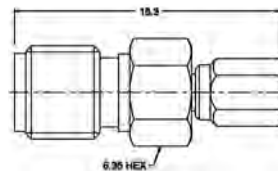

Part number	Interface
5945-9503-000	SMA female - SSMC female

Standard series adapters

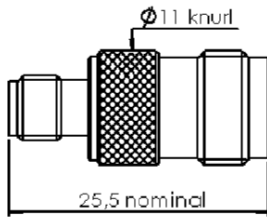

Part number	Interface
R191 315 000	SMA female - TNC female

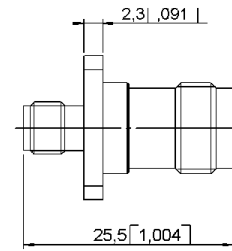

Part number	Interface	Panel drilling
R191 365 000	SMA female - TNC female	P02

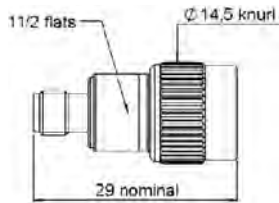

Part number	Interface
R191 313 000	SMA female - TNC male

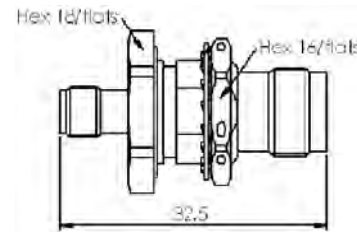

Part number	Interface	Panel drilling
R191 314 700	SMA female - TNC18 female	P04

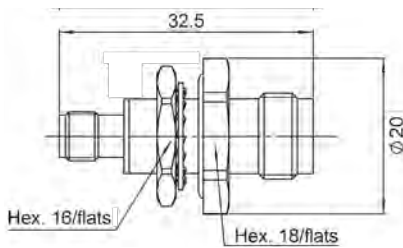

Part number	Interface	Panel drilling
R191 314 730	SMA female - TNC18 female	P08

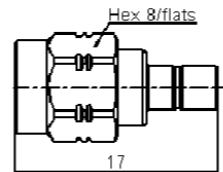

Part number	Interface
R191 200 007	SMA male - SMB male

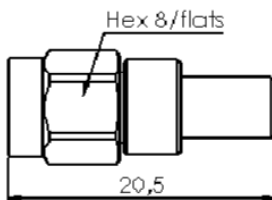

Part number	Interface
R191 374 000	SMA male - SMC female

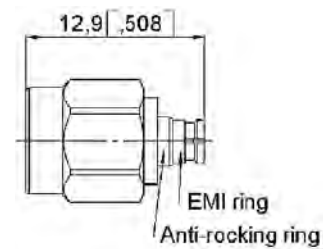

Part number	Interface
R191 842 002	SMA male - SMP female

Standard series adapters

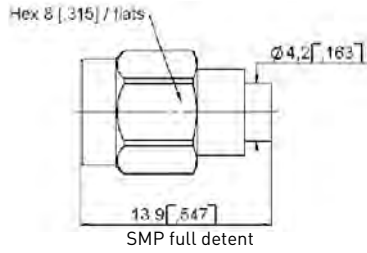

Part number	Interface
R191 841 001	SMA male - SMP male

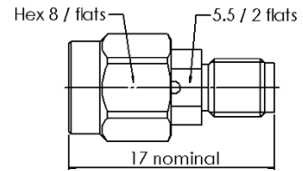

Part number	Interface
R191 347 000	SMA male - SSMA female

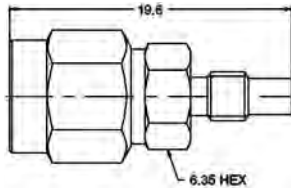

Part number	Interface
5938-1503-000	SMA male - SSMC male

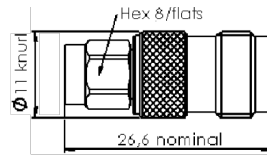

Part number	Interface
R191 311 000	SMA male - TNC female

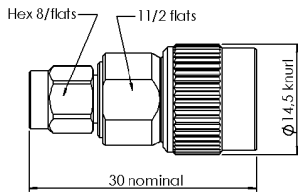

Part number	Interface
R191 309 000	SMA male - TNC male

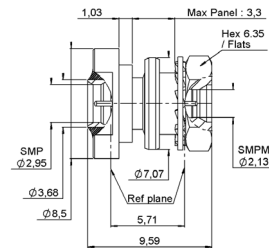

Part number	Interface
R191 570 100	SMP male - SMPM male

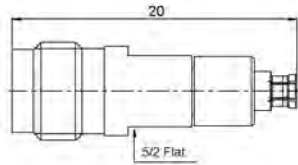

Part number	Interface
R191 565 000	SMPM Female - 2.4mm Female

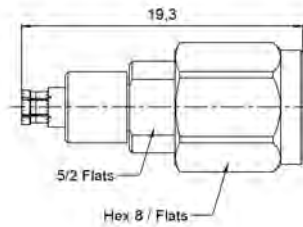

Part number	Interface
R191 563 000	SMPM Female - 2.4mm Male

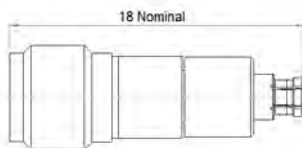

Part number	Interface
R191 959 000	SMPM female - 2.9mm female

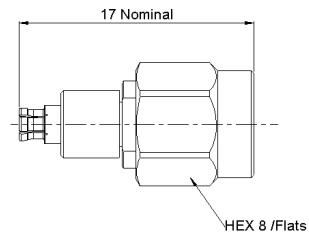

Part number	Interface
R191 957 000	SMPM female - 2.9mm male

Standard series adapters

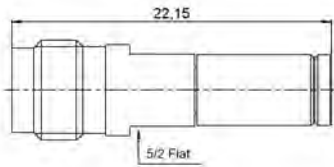

Part number	Interface
R191 564 000	SMPM male - 2.4mm female

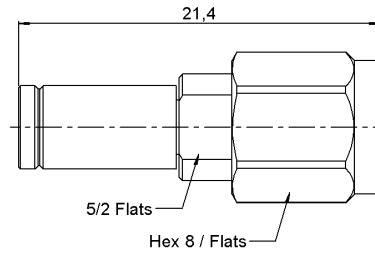

Part number	Interface
R191 562 000	SMPM male - 2.4mm male

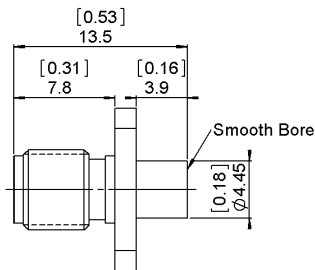

Part number	Interface
5964-9513-001	SMPM male - SMA female

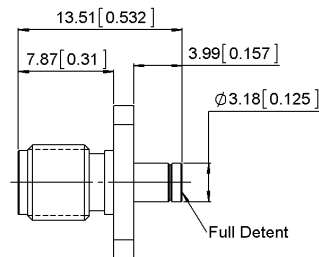

Part number	Interface
5965-9513-000	SMPM male - SMA female

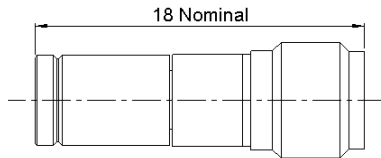

Part number	Interface
R191 958 000	SMPM male - SMA 2.9 female

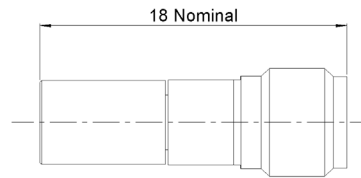

Part number	Interface
R191 958 020	SMPM male - SMA 2.9 male

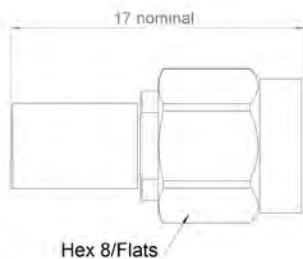

Part number	Interface
R191 956 020	SMPM male - SMA 2.9 male

Panel drilling

P01

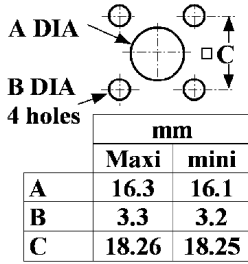

P02

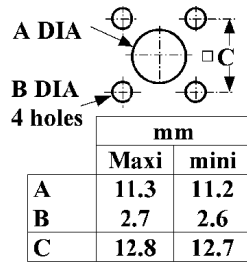

P03

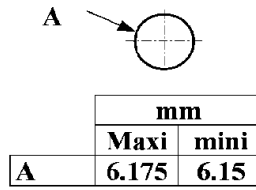

P04

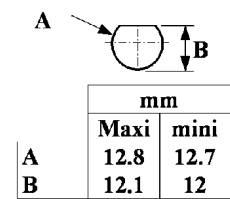

P05

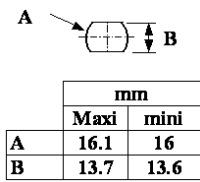

P06

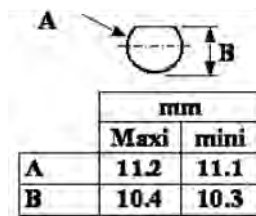

P07

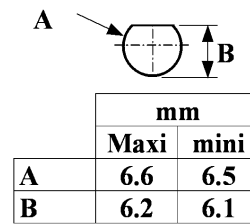

P08

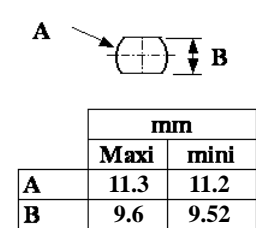

P10

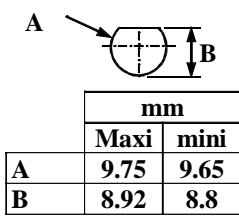

P11

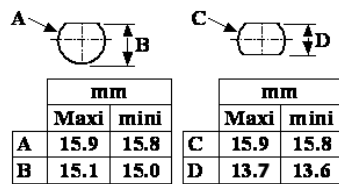

P12

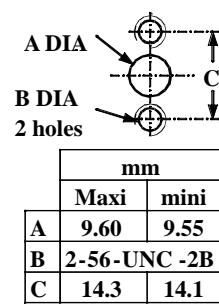

P13

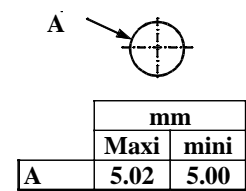

P14

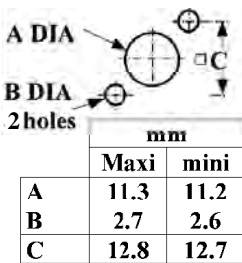

P15

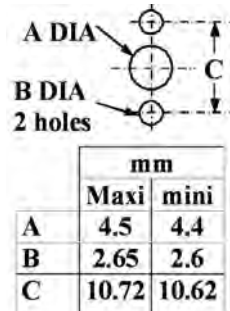

P16

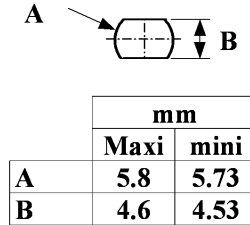

P17

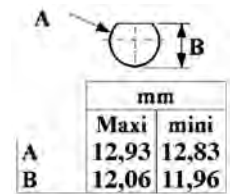



Tooling & Accessories
R280 / R282



Contents

TOOLING

Joule effect soldering devices 17-4

Stripping tools 17-4 and 17-7

Point gauges 17-4

Soldering 17-5

Installation tools 17-5 to 17-6

Cassettes 17-7

Kits for semi-rigid 17-8 to 17-10

Kit for microporous semi-rigid cables 17-11

Kits for flexible cables 17-11

Crimp tools 17-12 to 17-13

Torque wrench 17-14

Insertion and extraction tools 17-15 to 17-17

ACCESSORIES

Sliding contacts 17-17

Glass beads and EMI gaskets 17-18

Insulated washers 17-19

Solder tag 17-20

Panel sealing gaskets 17-20

Cable panel feedthrough 17-20

Cable terminations 17-21

Heatshrink sleeves 17-22

Cable boots 17-22

Panel drilling 17-23

SECTION 17 TABLE OF CONTENTS

Joule effect soldering devices, tools and pointer gauge

JOULE EFFECT SOLDERING DEVICES

Compliant with European standards n° 89/336/CEE and 73/23/CEE (electromagnetic compatibility and low voltage). It allows to solder:

- Center contacts and bodies to semi-rigid cables
- Center contacts to flexible cables
- Solder pot receptacles



Photo 1



Photo 2

Part number	Photo	Power	Delivered with
R282 800 000	1	80 Watts	Pliers + electrode: R282 800 020
R282 800 001	2	200 Watts	Pliers: R282 800 011 Electrode: R282 800 022

STRIPPING TOOL FOR SEMI-RIGID CABLE

This easy to use tool removes the cable's outer conductor and dielectric leaving the center conductor stripped to the proper length. It is supplied with a removal blade which can be ordered separately whenever required. Please specify P/N R282 055 000 when ordering the replacement blade, including adjustment gauge and male hex key.



Cable group	Cable group dia.	Part number
RG405	.085"	R282 051 000
RG402	.141"	R282 053 000
RG401	.250"	R282 054 000

POINTER GAUGE FOR SEMI-RIGID CABLE

Specially designed for sharpening the end of the cable's center conductor, this sharpening tool-gauge is supplied with a removable blade which can be ordered separately whenever required.



Cable group	Cable group dia.	Part number	Stripping length setting	Replacement blade
RG402	.141"	R282 066 000	2.17 (.085)	R282 056 118
		R282 067 000	3.17 (.125)	
RG405	.085"	R282 062 010	1.30 (.051)	R282 056 085
		R282 063 000	3.17 (.125)	

Soldering and installation tools

SOLDERING FIXTURE (JIG)

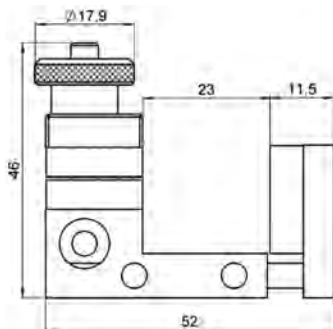

Cable group	Cable group dia.	Part number
RG405 / RG402 / RG401	.085"/.141"/.250"	R282 740 000
RG402 / RG401	.141"/.250"/.350"	R282 740 030

DRILLING TOOL FOR GLASS BEAD MOUNTING



Part number	Dia. (mm)
R282 080 000	1.98

Must be used with machine tool to obtain the required concentricity and dimensions.

SCREW TAP FOR HERMETIC RECEPTACLE SMA, BMA, ...



Part number	Dimension
R282 082 000	1/4 36 UNS 2B

INSTALLATION TOOL FOR SMA SCREW-ON FEMALE RECEPTACLES

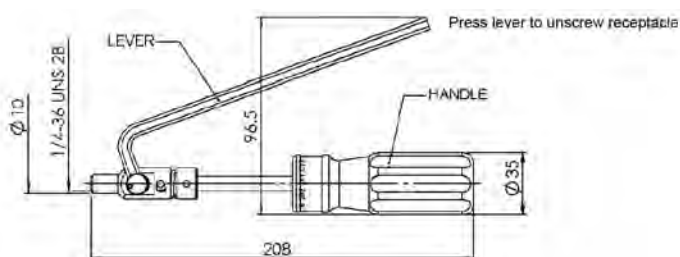

Part number	Coupling torque (N/cm)
R282 341 012	280
R282 341 010	190

Installation tools

INSTALLATION TOOL FOR BMA MALE RECEPTACLES R128 639 XXX

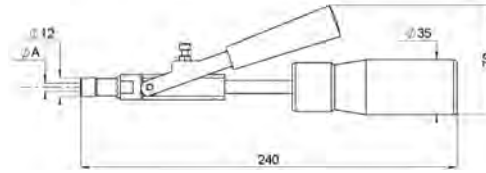

Part number	Coupling torque (N/cm)	Dimension A mm (inch)
R282 340 000	280	5.3 (.209)

TORQUE SCREWDRIVER FOR SMP THREAD-IN RECEPTACLES

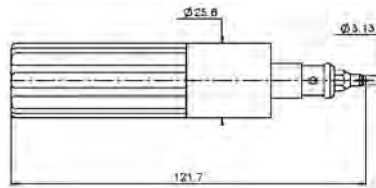
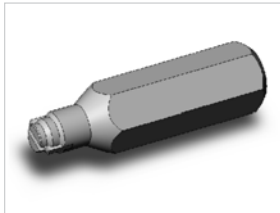

Fig. 1

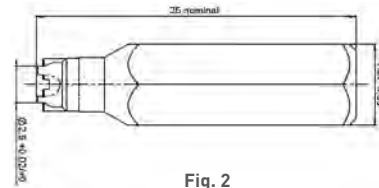

Fig. 2

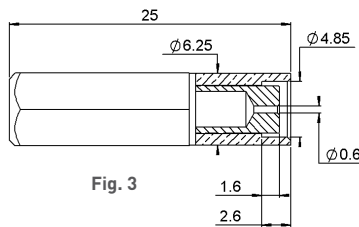

Fig. 3

Part number			Note	Coupling torque
With bit (fig.1)	Bit only (fig.2)	Bit only (fig.3)		
R282 339 001	R282 360 001		Full detent	7.96 lbf.inch (90cmN)
	R282 360 002		Limited detent	
	R282 360 003		Smooth bore	
R282 339 005		R282 360 004	For SMP-LOCK™ no hermetic	5.3 lbf.inch (60cmN)
R282 339 004		R282 360 004	For hermetic SMP-LOCK™	

TIGHTENING TOOL



Part number
R282 202 000

A new universal plier helps facilitate the tightening of coupling nuts. The removable inserts are made of plastic in order to avoid damage on the knurling (for ≈ 130 Ncm).

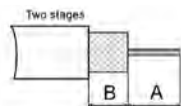

Stripping tools

STRIPPING TOOL R299 520 000 FOR CABLE DIA. 2.5 TO 8mm (RG58, RG59, RG62) (includes standard cassette R299 522 000)

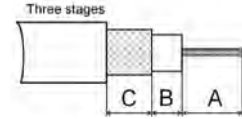

1) Dimension A in accordance with the plug stripping dimensions (not defined by the tool)

Part number	Designation	Stripping dimension
R299 520 000	Fixed-blade coaxial cable stripping tool for cable dia. 2.5 to 8.0 mm [.1" to .315"] Blades can be adjusted to precise cutting depths. Interchangeable blade cassette holders eliminate need to readjust blades	
R299 522 000	Adjustable blade, 2 or 3 stages	adjustable
R299 521 011	Replacement blade red, 2 stages	B = 6mm
R299 521 012	Replacement blade green, 3 stages	B = 5.1mm C = 7.1mm
R299 521 013	Replacement blade blue, 2 stages	B = 6.5mm
R299 521 014	Replacement blade yellow, 2 stages	B = 12mm
R299 521 015	Replacement blade grey, 2 stages	B = 3.9mm
R299 521 017	Replacement blade brown, 3 stages	B = 3.5mm C = 7.5mm

STRIPPING TOOL R299 550 000 FOR CABLE DIA. 2.5 TO 11mm



Part number	Designation
R299 550 000	Cable stripping range 2.5 to 11mm [.0984" to .4331"] Spring Tension - Squeeze to Open, Insert Cable & Rotate Around Jacket Delivers Smooth Consistent Strips. 9 Position Adjustable Depth Blade

KIT R299 510 010: STRIPPING TOOL FOR 2.5 TO 7.6mm DIA. FLEXIBLE CABLES (without cassette)

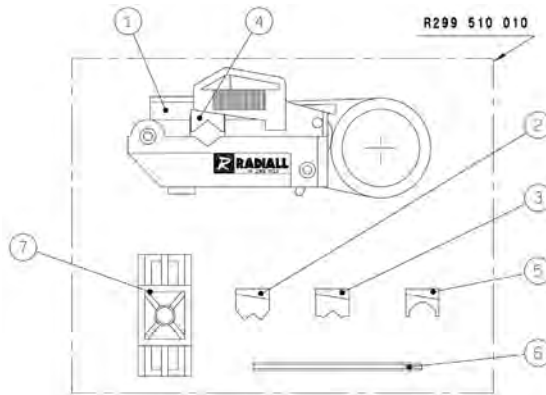

Part number	Designation
R299 510 010	STRIPPING TOOL 1 - Stripping tool 2 - White V guide for dia ext. cable 2.5 to 3 mm 3 - Red V guide for dia ext. cable 3 to 5 mm 4 - Blue V guide for dia ext. cable 5 to 6.4 mm 5 - Yellow V guide for dia ext. cable 6.4 to 7.6 mm 6 - Wrench 7 - Gauge

CASSETTES FOR R299 510 010

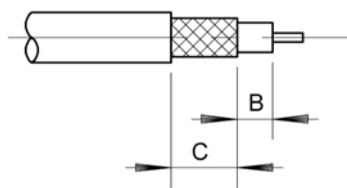
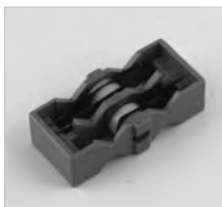

Part number	Designation	Length B (mm)	Length C (mm)
R299 511 013	Orange stripping cassette	3.5	6.5
R299 511 016	White stripping cassette	1.5	6.3
R299 511 011	Green stripping cassette	6.0	6.9
R299 511 012	Yellow stripping cassette	2.0	8.0

Kits for semi-rigid cables

R282 102 000: Bending kit



N°	Part number	Designation	Old cross reference	Mark
1	R282 750 000	Bending	730 11 000	[09]
2	R282 751 050	Bending gauge .085"	730 11 040	[02]
3	R282 751 051	Bending gauge .085"	730 11 030	[01]
4	R282 751 070	Bending gauge .141"	730 11 060	[04]
5	R282 751 080	Bending gauge .250"	730 11 070	[05]
6	R282 751 071	Bending gauge .141"	730 11 050	[03]

KIT: Stripping + sharpening for semi-rigid cables



R282 114 125: Stripping 3.17 (.125) + sharpening for .085" semi-rigid cables

N°	Part number	Designation
1	R282 051 000	Stripping tool .085"
2	R282 055 000	Replacement stripping blade
3	R282 864 110	Blade installation gauge .085"
4	R282 344 150	Hex 1.5 (.059)
5	R282 063 000	Sharpening and length-setting tool 3.17 (.125") long on .085"
6	R282 056 085	Replacement sharpening blade
7	R282 344 127	Hex 1.27 (.05)

Kits for semi-rigid cables

R282 114 162: Stripping 2.17 (.085) + sharpening for .141" semi-rigid cables

N°	Part number	Designation
1	R282 053 000	Stripping tool .141"
2	R282 055 000	Replacement stripping blade
3	R282 864 120	Blade installation gauge .141"
4	R282 344 150	Hex 1.5 (.059)
5	R282 066 000	Sharpening and length-setting tool 2.17 (.085") long on .141"
6	R282 056 118	Replacement sharpening blade
7	R282 344 127	Hex 1.27 (.05)

R282 114 165: Stripping 3.17 (.125) + sharpening for .141" semi-rigid cables

N°	Part number	Designation
1	R282 053 000	Stripping tool .141"
2	R282 055 000	Replacement stripping blade
3	R282 864 120	Blade installation gauge .141"
4	R282 344 150	Hex 1.5 (.059)
5	R282 067 000	Sharpening and length-setting tool 3.17 (.125") long on .141"
6	R282 056 118	Replacement sharpening blade
7	R282 344 127	Hex 1.27 (.05)

R282 120 010: SMA solder kit (suitable for commercial and standard SMA)



N°	Part number	Designation	Mark
1	R282 059 100	Cable holder	
2	R282 862 060	Solder gauge (cab .085": mark 61, cab .141": mark 62)	
3	R282 744 200	Soldering locator tool for right angle SMA	(84)
4	R282 053 100	Stripping tool	
5	R282 066 100	Trimmer	
6	R282 744 220	Soldering locator tool for center contact	
7	R282 744 060	Soldering locator tool for male SMA cable .085"	(85)
8	R282 744 062	Soldering locator tool for male SMA B cable .085"	(78)
9	R282 744 201	Soldering locator tool for right angle SMA B	(88)
10	R282 744 010	Soldering locator tool for female cable .085"	(80)
11	R282 744 011	Soldering locator tool for female cable .141"	(86)
12	R282 200 000	Retaining ring pliers	
13	R282 760 000	Retaining insert tool	
14	R282 915 010	Dielectric recess tool	
15	R282 914 010	Dielectric recess gauge for female	(92)
16	R282 857 010	Control gauge for female	(81)
17	R282 744 100	Soldering locator tool for male	(82)
18	R282 857 000	Control gauge for male	(83)
19	R282 914 000	Dielectric recess gauge for male	(93)
20	R282 744 063	Soldering locator tool for male SMA B cable .141"	(77)
21	R282 744 061	Soldering locator tool for male SMA cable .141"	(87)
22	R282 740 000	Soldering fixture	
23	R282 730 040	Dielectric insert tool + dielect plunger for female	
24	R282 730 043	Dielectric insert tool + dielect plunger for male	

Kits for semi-rigid cables

R282 122 010: TNC 18 Ghz solder kit



N°	Part number	Designation	Mark
1	R282 744 271	Soldering locator tool for male	[128]
2	R282 744 270	Soldering locator tool for female	[129]
3	R282 370 020	Locking tool	[132]
4	R282 740 000	Soldering fixture	[10]
5	R282 744 000	Soldering locator tool for .085" cable	
6	R282 744 003	Soldering locator tool for .141" cable	[133]
7	R282 915 020	Dielectric recess tool	[97]
8	R282 862 100	Solder gauge	[63]

R282 125 010: Solder kit for N connectors

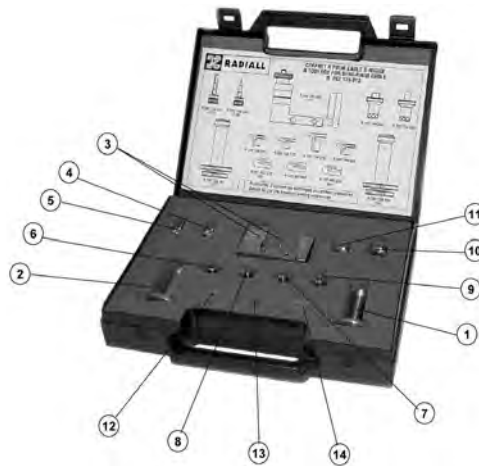

N°	Part number	Designation	Old cross reference	Mark
1	R282 730 160	.250" dielectric insertion tool + plunger for N jacks	730 25 007	[36]
2	R282 730 161	.141" dielectric insertion tool + plunger for N jacks	730 25 008	[37]
3	R282 740 030	Soldering fixture	730 15 022	[11]
4	R282 744 260	N soldering fixture for female centre contact	730 40 005	[126]
5	R282 744 261	N soldering fixture for male centre contact	730 40 006	[127]
6	R282 744 300	N soldering fixture for cable .085"		
7	R282 744 310	N soldering fixture for cable .141"		
8	R282 744 320	N soldering fixture for cable .141"		
9	R282 744 330	N soldering fixture for cable .250"		
10	R282 744 340	Soldering fixture for N plug cable .141"		
11	R282 744 350	Soldering fixture for N plug cable .250"		
12	R282 862 070	Solder gauge thickness 0.35 (.0138")	730 15 170	[62]
13	R282 862 080	Solder gauge thickness 0.45 (.0177")		
14	R282 862 090	Solder gauge thickness 0.70 (.0276")	730 15 180	[64]
15	R282 915 030	Dielectric recess tool for cable .141"		
16	R282 915 040	Dielectric recess tool for cable .250"		

Kit for microporous semi-rigid cables

R282 120 220: Solder kit for SMA 2.9

No.	REFERENCE	DESIGNATION
1	R282 323 000	Torque wrench
2	R282 061 030	Pointer gauge for cable .085 MP
3	R282 067 030	Pointer gauge for cable .141 MP
4	R282 744 190	Soldering positioner cable .085
5	R282 744 192	Soldering positioner cable .141
6	R282 740 000	Soldering assembly jig
7	R282 053 030	Stripping tool cable .141 MP
8	731 22 034A	Stripping tool cable .085 MP
9	R282 059 010	Cable holder

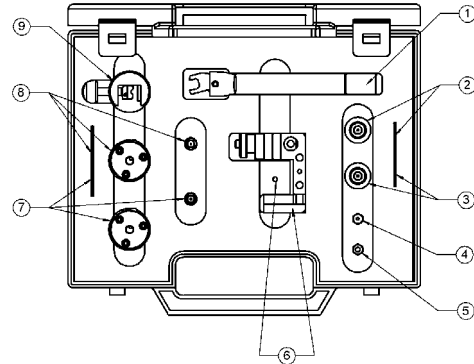

Kits for flexible cables

**R282 124 100:
Stripping + crimping
kit for cables 10+11/50/s+d**



N°	Part number	Designation
1	R282 231 000	Crimping tool
2	R282 078 200	Green stripping cassette
3	R282 078 220	Green stripping cassette
4	R282 078 500	Adjustment bit
5	R282 078 000	Universal tool body a - Red V guide for dia ext. cable 7 to 9 mm b - Blue V guide for dia ext. cable 9 to 11.5 mm c - Yellow V guide for dia ext. cable 11.5 to 14 mm d - Two interior supports e - Universal tool body f - Adjustment bit (Identical R282 078 500) g - Wrench

Inside the box, every part number can be ordered separately.

Crimp tools



MIL CRIMP TOOL (M22520/5-01) R282 293 000 (dies not included)

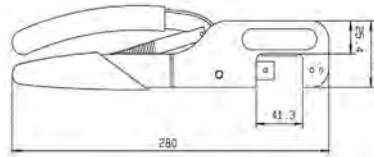

DIES FOR R282 293 000



Cable group	Cable group dia.	Part number			
		Dieset only	Tool complete with dies		
RG178 / RG196 / RD178 / RG174 / RG316 / RG179	2/50/S+D - 2.6/50+75/S	R282 235 003	TA-0105	3.25 (.128)	2.67 (.105)
RG58 / RG141 / RG142 / RG223 / RG400	5/50/S - 5/50/D	R282 235 011		5.41 (.213)	1.73 (.068)
KX6-RG62	6/75 + 93	R282 235 013		6.48 (.255)	1.73 (.068)

CRIMP TOOL (dies included)

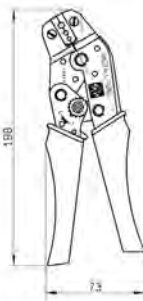

Fig. 1



Fig. 2



Fig. 3

Part number	Fig.	Cable group	Cable group dia.	Color of handles			
R282 211 000	1	.046"OD / .048"OD - RG178 / RG196 / .075"OD RG174 / RG316 / RF179	1/50+75 - 2/50/S+75 - 2.6/50/S+75	Red	4.52 (.178)	3.25 (.128)	2.67 (.105)
R282 223 000		RG122 / RG58 / RG62	4/50+75 - 5/50 - 6/75+93	Orange	6.48 (.255)	5.41 (.213)	1.73 (.068)
R282 227 000	3	RG6	8/75+95	Blue	8.23 (.324)		1.73 (.068)
R282 231 000	2	RG393 / RG214	10/50/D - 10.3/50/S - 11/50/D	Yellow	10.54 (.415)	2.54 (.1)	
R282 232 000	3	RD179 / mini RG159 / RG6	4.0/75/D-7/75D	Blue	6.7(.236)	5.4(.213)	Square 1.1(.043)
R282 234 000		RG59	6/75D	Black	6.98(.275)	6.48(.255)	Square 1.15(.0452)
R282 271 000		RG178 / RG174 / RG316 / RD316 / RG179 / RD179	2/50+75 - 2.6/50+75/S+D	Black	3.84 (.131)	3.25 (.128)	0.72* (.028)

* Square crimping die.

Crimp tools

BNC TOOLKITS

Part number	Designation
R282 124 050 (50Ω)	1x R282 223 000 Crimp tool for cable diameter 5 or 6 mm. Hex.: 1.73/5.41/6.48 15x R141 082 161 BNC male, straight, crimp for RG58 1x R299 520 000 Strip tool 1x R299 521 017 Replacement blade brown, 3 step for RG58, RG59

Part number	Designation
R282 124 075 (75Ω)	1x R282 223 000 Crimp tool for cable diameter 5 or 6 mm. Hex.: 1.73/5.41/6.48 15x R142 085 161 BNC male, straight, crimp for RG59 1x R299 520 000 Strip tool 1x R299 521 017 Replacement blade brown, 3 step for RG58, RG59



CRIMP TOOL R282 281 000 FOR CENTER CONTACTS

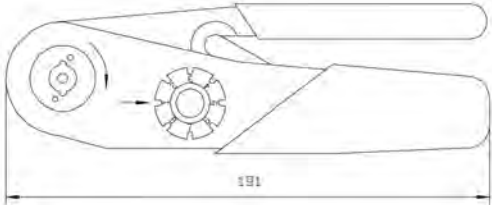

LOCATOR TOOL FOR CENTER CONTACT CRIMP TOOL R282 281 000



Part number	Note
R282 967 030	For pin contact for socket contact
R282 983 000	

Torque wrench

TORQUE WRENCH 4 TO 10mm

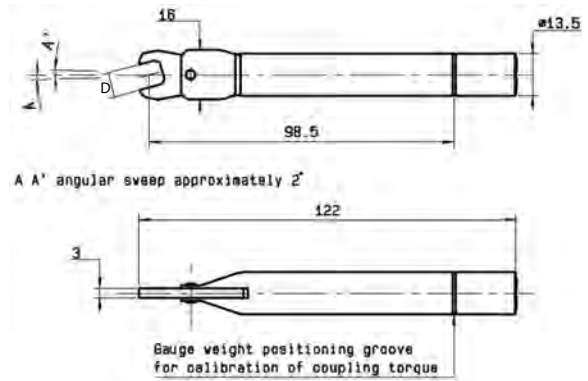

Part number	Across flats D (mm)	Coupling torque (N.cm)
R282 318 000	6 (.236)	30
R282 319 000	6.35 (.250)	60 to 80
R282 320 000	8 (.315)	80 to 120
R282 320 030		60
R282 320 031		70
R282 323 000	6.5 (.256)	80 to 120
TA-0456	8 (.315)	395 (35 lbf-in)
TA-0398	5.5 (.218)	34 (48 oz-in)
TA-0432	4.0 (.156)	21 (30 oz-in)
TA-0436	5.5 (.218)	68 (96 oz-in)

TORQUE WRENCH 10 TO 21 MM

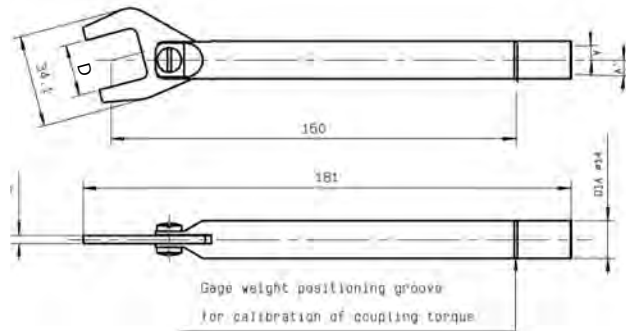

Part number	Across flats D (mm)	Coupling torque (N.cm)
R282 300 000	14 (.550)	265
R282 303 020	18 (.710)	170
R282 303 000	19 (.748)	160
R282 303 010		130
R282 303 230	21 (.827)	400

TORQUE WRENCH 32 MM

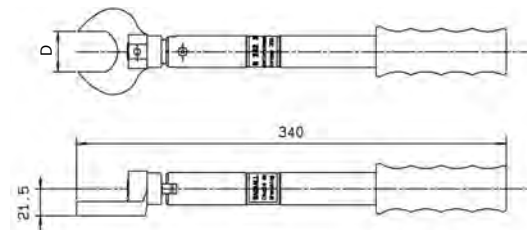

Part number	Across flats D (mm)	Coupling torque (N.cm)
R282 303 500	32 (1.260)	3500

Insertion and extraction tools

EXTRACTION TOOLS FOR BMA & COAXIPACK 2

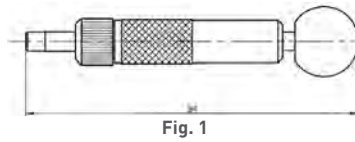

Fig. 1

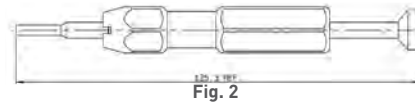

Fig. 2

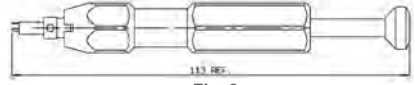
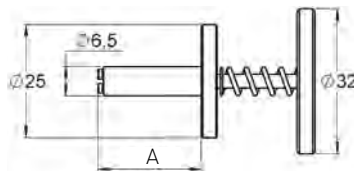

Fig. 3

Part number	Fig.	Use	Note
R282 918 000	1		For removing BMA floating plug
R282 918 150	1		For removing SMP snap-in R222 223 XXX
R282 920 010	2	U01	For male COAXIPACK 2 inserts
R282 920 100	3	U02	For female COAXIPACK 2 inserts

SMPM/SMP EXTRACTION TOOLS FOR ADAPTERS



Part number	A dimension	Adapters
R282 918 200	23mm	SMPM R201 705 XXX
R282 918 120	150mm	SMP R222 705 XXX

SMPM/SMP/SMP-LOCK EXTRACTION TOOLS (for right angle cable plugs)



Fig. 1

Part number	Fig.	Plugs
R282 918 160	1	SMP R222 15X XXX
R282 868 300	1	SMP-LOCK R222 LXX XXX
R282 918 210	1	SMPM R201 15X XXX

COAXIPACK 2 EXTRACTION TOOL

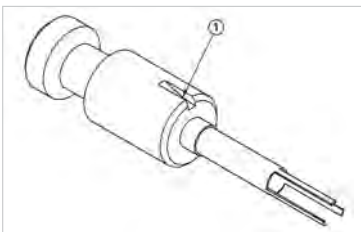

Part number
R282 920 120

HDC 43 INSERTION & EXTRACTION TOOL

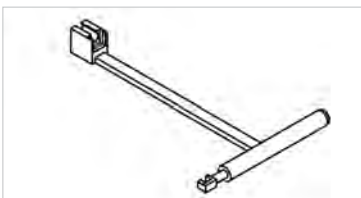

Part number
R282 868 201

Extraction tools

UMP EXTRACTION TOOL



Photo 1

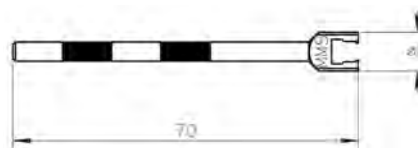
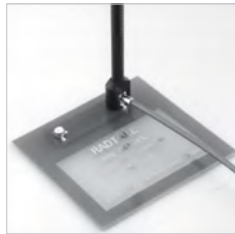

Photo 2

Part number	Photo	Note	To disconnect
R282 867 020	1	Axial disconnection	H2
R282 867 030	2	Lateral disconnection	H2, H2.6 & H3

This tool only applies to lock version. No tool needed for UMP snap of slide versions

MMS AND MMT EXTRACTION TOOL



Part number	Series
R282 868 040	MMT
R282 868 100	MMS

Materials and finish: black anodized aluminium. The anodization allows the electric insulation and protects from the oxidization.

MML EXTRACTION TOOLS



Part number	To disconnect	Packaging
R302 309 000	H2.5 & H2.0	Unit
R302 159 000	H1.5	

QMA EXTRACTION TOOL (optional for high density applications)

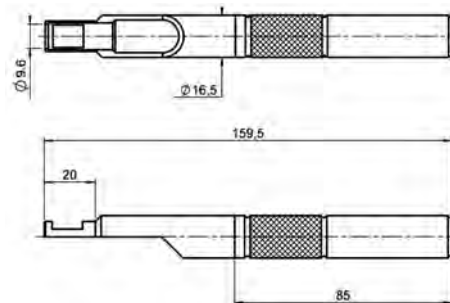

Part number
R282 868 230

This tool can be used with either straight or right angle connectors.

QRE EXTRACTION TOOL

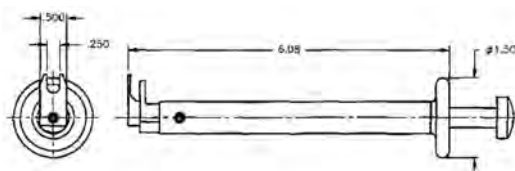

Part number
TA-0457

This tool can be used with either straight or right angle connectors.

Extraction tools and sliding contacts

EXTRACTION TOOL FOR RIGHT ANGLE MCX AND MMBX CONNECTORS AND CAP MOUNTING



Part number	Flat dimension: inch (mm)
R282 868 000	.276 (7)

This tool has two functions
 - Fitting cover on right angle connectors
 - Extraction of these models after coupling

OPTIONAL SLIDING CONTACTS AND INSULATORS

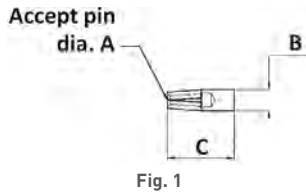

Fig. 1



Fig. 2

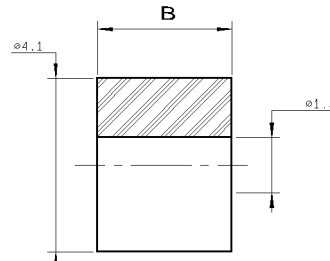

Fig. 3

Type	Part number	Fig.	Dimensions (mm)			Packaging
			A	B	C	
Socket	R280 181 000	1	0.9	1.28	14.8	10 pieces
	R280 469 000		0.3	0.85	3.43	
	R280 469 010		0.46			
	R280 470 000		0.28/0.38	0.77	1.84	
	R280 470 050		0.46			
Pin	R280 473 100	2		0.30	2.80	Unitary
	R280 473 130			0.5	5.6	
Insulator	R280 467 000	3		1.57		10 pieces
	R280 468 000			3.17		
	R280 468 120			10.1		
	R280 468 140			6.38		

CONTACTS FOR FIELD REPLACEABLE RECEPTACLES, DIAMETER 0.93mm (.037")

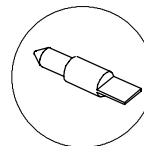
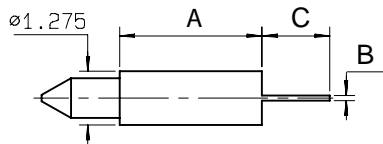

Fig. 1

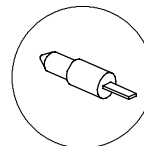

Fig. 2

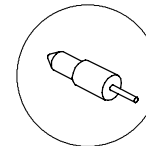
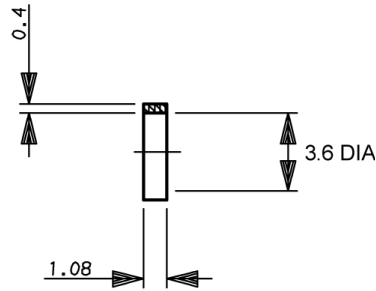

Fig. 3

Part number	Fig.	Termination	A	B	C	Packaging
R280 461 000	1	Tab	3.37	0.13	1.6	10 pieces
R280 461 200	2	Tab special	3.37	0.13 x W0.51	1.6	
R280 461 210	1	Tab	10.3	0.13	1.6	
R280 462 000	3	Cylindrical	1.77	dia 0.25	1.57	
R280 463 000			3.37			
R280 465 000	2	Tab special	0.2	0.13 x W0.60	0.9	

Glass beads and EMI gaskets

EMI/RFI GASKET



Part number	Packaging
R280 510 000	10 pieces

GLASS BEAD/HERMETIC SEALS

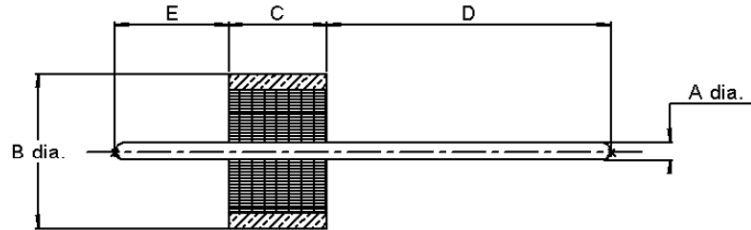

Hermeticity guaranteed at 10^{-8} atm.cm³/s

Part number	Dimensions (mm)					Packaging	
	A	B	C	D	E		
R280 751 000	0.30 [.012]	2.52 [.099]	1.60 [.063]	4.57 [.180]	1.83 [.072]	1	
R280 751 080				1.3 [.051]		100	
R280 751 350				4.57 [.180]		1.83 [.072]	1
R280 752 000	0.38 [.015]	2.50 [.098]	1.56 [.061]	1.95 [.076]	1.59 [.062]	100	
R280 752 020				1.3 [.051]			
R280 755 000	0.46 [.018]	2.85 [.112]	1.60 [.063]	4.57 [.180]	1.83 [.072]	1	
R280 755 040							
R280 757 060	0.50 [.109]	4 [.157]	1.77 [.070]	1.78 [.070]	2.03 [.080]	100	
R280 757 070				5.82 [.230]		1.93 [.076]	1
R280 757 080				1.78 [.070]		1.93 [.076]	1
R280 760 000	0.30 [.012]	1.93 [.076]	1.40 [.055]	0.74 [.029]	1.04 [.041]	5	
R280 760 040				1.10 [.043]		1.72 [.068]	100
R280 760 050				1.10 [.043]		1.72 [.068]	

Insulated washers

INSULATED WASHERS

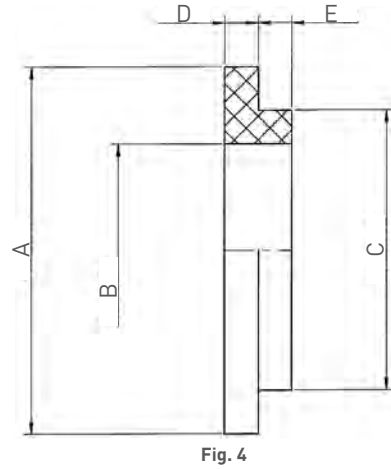
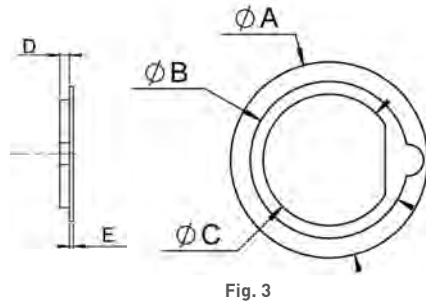
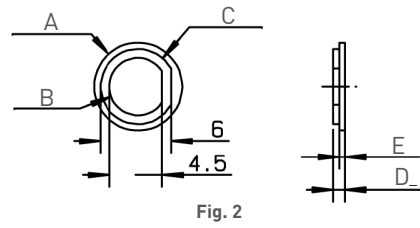
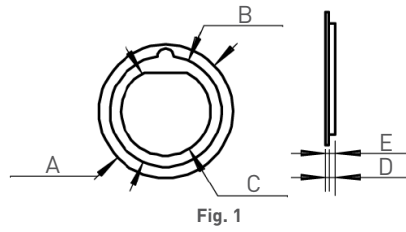

Part number	Fig.	To be used on (partial list)		Dimensions (mm)					Material	Packaging
				A	B	C	D	E		
R280 907 000	1	R141 304 000 R141 323 000 R141 324 000 R141 327 000 R141 332 161 R141 332 500	R141 338 000 R141 730 000 R141 753 000 R142 329 000 R142 334 161 R142 720 000	19.06	15.88	12.7	1.02	0.44	Nylon	100 sets (200 washers)
99762	3	R142 306 500 R142 306 503	R141 301 000 R141 303 503 R141 306 000 R141 306 503 R141 308 000	14.3	11.45	9.58	1	0.4		
R280 902 000	2	R142 562 290		16	12.6	9.6	1.5	0.7		
539 22 090	4	R125 720 000 R125 720 001 R125 722 001		11	8.4	6.4	1	1		

TAG, gaskets and feedthrough

SOLDER TAG

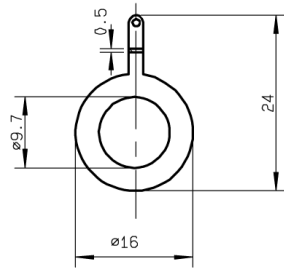

Part number	Finish	Packaging
R280 490 020	Nickel	100 units

PANEL SEALING GASKETS

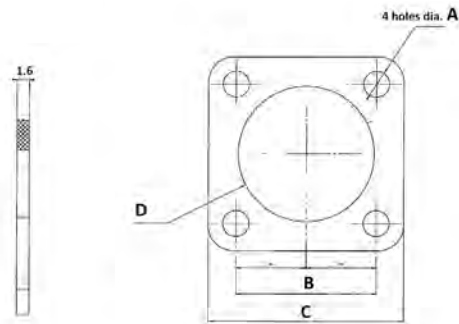

Part number	Series	Dimensions (mm)				Material
		A	B	C	D	
R280 505 000	N	∅ 3.4	18.25	25.4	17.7	Neoprene
R280 503 000	BNC	∅ 3	12.7	17.5	11.5	

CABLE PANEL FEEDTHROUGH

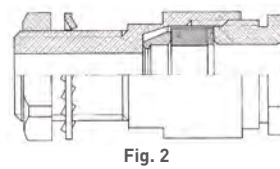
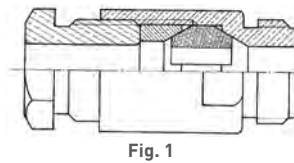

Part number	Fig.	Mounting type	Panel hole size	Cable group dia.	Cable group
R280 007 000	1	Thread-in	7/16 - 14 UNC 2A	5/50	RG58 / RG141 / RG142
R280 009 000			7/16 - 28 UNEF 2A		
R280 010 000			7/16 UNC 2A	6/75	RG59 / RG62
R280 019 000			11/16 24 NEF 2A	10/50 11/50	RG213 / RG393 / RG214 / RG216
R280 054 000	2	Bulkhead	4.9 mm	3 Max	RG178 / RG174 / RG316 / RG179
R280 257 000			8 mm	5/50	RG58 / RG141 / RG142
R280 254 000			4.9 mm	2.6/50	RG174 / RG178 / RG179

Cable terminations

RIGHT ANGLE PCB CABLE TERMINATIONS

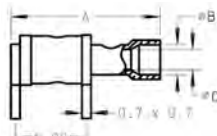

Fig. 1

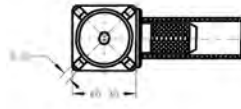

Fig. 2

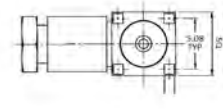

Fig. 4

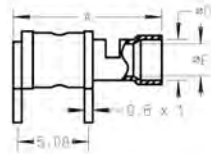

Fig. 3

Cable group	Cable dia.	Part number	Fig.	Dimensions (mm)			Panel drilling	Finish	Note
				A	B	C/E			
RG178 / RG196	2/50/S	R280 219 000	1	10.70	2.10	1.45	P03	Gold	2 pins /solder
		7145-1521-002	2	9.39	9.65	1.01	-		4 pins /crimp
RG174 / RG316 / RG179	2.6/50+75/S	R280 220 008	3	10.70	2.90	2.30	P04	Tin lead	2 pins /solder
		R280 294 000	2	16.85	3.25	1.70	P01		4 pins /crimp
RG405	.085"	8045-1541-010	4	14.98	3.07		-	Gold	4 pins /clamp
RG174 / RG316	2.6/50S	8045-1551-003							
		8145-1521-003							
RG178 / RG196	2/50S	8145-1521-002		17.44	3.09		P01		4 pins /crimp
RD316	2.6/50D	8145-1521-019			3.50				

STRAIGHT PCB CABLE TERMINATIONS

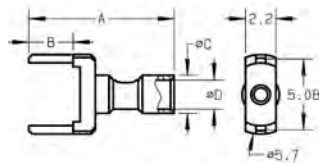

Fig. 1

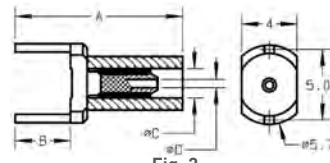

Fig. 2

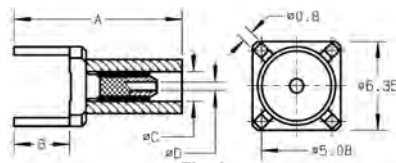
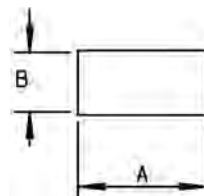
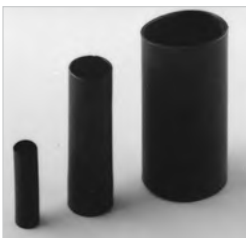

Fig. 3

Cable group	Cable dia.	Part number	Fig.	Dimensions (mm)				Panel drilling	Finish	Note
				A	B	C	D			
RG178 / RG196	2/50/S	R280 221 000	1	10.50	3.20	2.70	1.45	P02	Gold	2 pins /solder
RG174 / RG316 / RG179	2.6/50 - 2.6/75/S	R280 222 000	2	8.40	3.20	3.15	2.30			
		R280 284 000	3	17.20	4.00	3.25	1.70	P01	Nickel	4 pins /crimp

HEATSHRINK SLEEVES



Part number	B		A	Packaging
	Before shrinkage	After shrinkage		
R280 637 030	6.4	3.2	25.4	100
R280 637 040	12	6	45	

Heatshrink sleeves guarantee an IP65 moisture resistance on crimp type models and an IP 67 moisture resistance on clamp type models.

Heatshrink sleeves and cable boots

PROTECTIVES CAPS (material: PVC color: red)

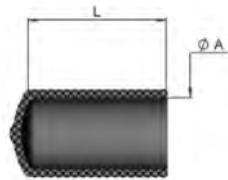

These caps protect the interface against dust and accidental interface damage during storage or handling.

Part number	Dimensions		Connectors series using these caps
	ØA	L	
240 92 682	6	11.1	SSMA male, SMB female
240 92 671	6	19	SMA female, SMC female jack
240 92 672	8.7		SMA male
240 92 684	9		QMA male
240 92 673	10.3	22.2	TNC female, BNC female
240 92 674	13.5	25.4	TNC male, C female
240 92 675	14.3	25.4	BNC male
240 92 676	15.9		N female
240 92 677	17.4		C male
240 92 678	19	12.7	N male, HN female
A240 92 010	20.63		7/16 male
240 94 681	4	11.1	SSMA female, QMA female, 10/23 female, SMC male plug
241 92 040	29	10.5	7/16 female
Z241 92 080	20	30.5	4.3-10 female jack

CABLE BOOTS (material: PVC)

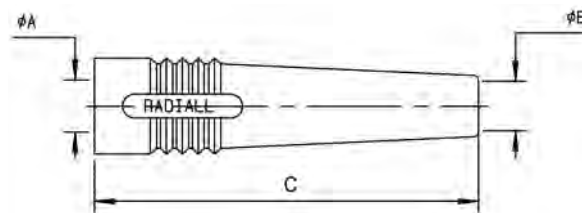

Cable group Color	2.6/50		5/50	6/75
	A: 5.5 - B: 2.6 C: 27	A: 5.5 - B: 2.6 C: 48	A: 5.5 - B: 5.1 - C: 48	A: 6.5 - B: 6.2 - C: 48
Black	R280 560 000	R280 566 000	R280 570 010 / R280 570 000*	R280 590 000
Red	R280 560 001	R280 566 001	R280 571 000	R280 591 000
Green	R280 560 002	R280 566 002	R280 572 000	R280 592 000
Blue	R280 560 003	R280 566 003	R280 573 000	R280 593 000
Yellow	R280 560 004	R280 566 004	R280 574 000	R280 594 000
Grey	R280 560 005	R280 566 005	R280 575 000	R280 595 000
White	R280 560 006	R280 566 006	R280 576 000	R280 596 000
Brown	R280 560 007	R280 566 007	R280 577 000	R280 597 000
Orange	R280 560 008	R280 566 008	R280 578 000	R280 598 000
Violet			R280 579 000	

Standard packaging = 10 pieces - * packaging = 100 pieces

Panel drilling

P01

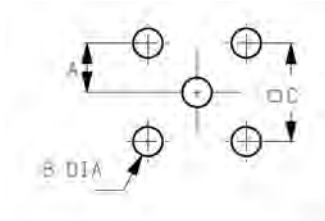

	MM		INCH	
	maxi	mini	maxi	mini
A	2.56	2.52	0.101	0.099
B	1.4	1.3	0.055	0.051
C	5.13	5.03	0.202	0.198

P02

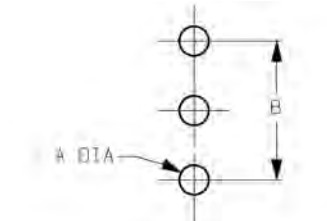

	MM		INCH	
	maxi	mini	maxi	mini
A	1.15	1.05	0.045	0.041
B	5.15	5.05	0.203	0.199

P03

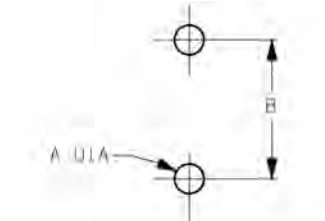

	MM		INCH	
	maxi	mini	maxi	mini
A	1.10	1.00	0.043	0.039
B	5.13	5.03	0.202	0.198

P04

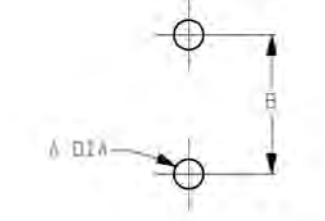

	MM		INCH	
	maxi	mini	maxi	mini
A	1.5	1.4	.059	.055
B	5.13	5.03	.202	.198

ACCESSORIES



Coaxial Cable Assemblies
C291



Contents

CABLE ASSEMBLIES

Introduction 18-4
 Specify the right cable for your application 18-5
 Finder guide cables vs insertion loss 18-6 to 18-7

FLEXIBLE CABLES (STANDARD)

0.8/50 S cable (132390 type) 18-8
 1/50 S cable (50VMTX type) 18-8
 1/75 S cable (75VMTX type) 18-9
 2/50 S cable (RG178-KX21A-RG178 non mag) 18-9 to 18-10
 2/50 D cable (124416 type) 18-10
 2/75 S cable (296775 type) 18-11
 2.6/50 S cable (RG174-KX3B-RG316-KX22A) 18-11 to 18-12
 2.6/50 D cable (RD316) 18-12
 2.6/75 S cable (RG179) 18-13
 4.6/75 D cable (HD 0.6/2.8-mini RG59 type) 18-13
 5/50 S cable (RG58-KX15) 18-14
 5/50 D cable (RG142-RG223-RG400-KX23) 18-14 to 18-16
 6/75 S cable (RG59-KX6A) 18-16 to 18-17
 6/75 D cable (HD 0.8/3.7-RG59 type) 18-17
 7/75 D cable (HD 1.0/4.8-RG6 type) 18-18
 10/50 S cable (RG213-KX4) 18-18
 10/50 D cable (RG393) 18-19
 11/50 D cable (RG214-KX13) 18-19
 11/75 D cable (RG216) 18-20

FLEXIBLE CABLES (LOW-LOSS ECO-FRIENDLY)

2.6/50 S cable (ECO316-ECO316X) 18-20 to 18-21
 2.6/50 D cable (ECO316D-ECO316DX) 18-21 to 18-22
 5/50 D cable (ECO142-ECO142X-Power142) 18-22 to 18-23
 6/50 D cable (ECO230) 18-24
 10/50 D cable (ECO393-ECO393X) 18-24 to 18-25

CORRUGATED CABLES

Cable 1/4" spiral (HCF 1/4"-50 AlCu) 18-25
 Cable 3/8" spiral (HCF 3/8" CuH-50 AlCu) 18-26
 Cable 1/2" spiral (HCF 1/2" CuH-50 AlCu) 18-26

SEMI-RIGID AND HAND-FORMABLE CABLES

.047" cable (SR copper-SR tinned copper) 18-27
 .085" cable (Handformable unjacketed-SR RG405/KS1-SR tinned copper-SR non magnetic-SR aluminium) 18-28 to 18-30
 .141" cable (Handformable unjacketed-Handformable FEP jacketed-SR RG402/KS2
 SR tinned copper-SR silvered copper-SR non magnetic-SR aluminium) 18-30 to 18-33
 .250" cable (SR RG401/KS3-SR aluminium) 18-34

LOW-LOSS FLEXIBLE CABLES

AEP-100FR (LMR® 100) 18-35
 AEP-195FR (LMR® 195) 18-36
 AEP-200FR (LMR® 200) 18-37
 AEP-240FR (LMR® 240) 18-38
 AEP-400FR (LMR® 400) 18-39
 AEP-600FR (LMR® 600) 18-40

SHF ULTRA LOW LOSS CABLES 18-41 to 18-44

Radiall cable groups

Example for flexible cables: 5/50 S	<ul style="list-style-type: none"> — Cable outer diameter in mm (2.6 mm, 5 mm, 10 mm, 11 mm,...) — Characteristic impedance (50Ω, 75Ω) — Number of shields (S=single, D=double)
Example for corrugated cables: 1/2 spiral	<ul style="list-style-type: none"> — Cable outer conductor diameter in fraction of inch (1/4", 3/8", 1/2",...)
Example for semi-rigid & handformable cables: .141"	<ul style="list-style-type: none"> — Cable outer conductor diameter in inches (.085", .141", .250",...)

Introduction

Radiall is globally recognized as a leading manufacturer of coaxial connectors, cable and cable assemblies.

Radiall has the best manufacturing technology and processes. As a result, we are one of the only manufacturers that have fully mastered foam PTFE wrapping technology. This capability enables us to supply cable assemblies featuring the highest level of performance, stability and repeatability.

In addition, Radiall has high precision stripping and cutting machines, soldering and cleaning equipment.

Radiall offers five standard ranges of cable for a wide variety of applications for the telecom, military, instrumentation, medical and broadcast markets.

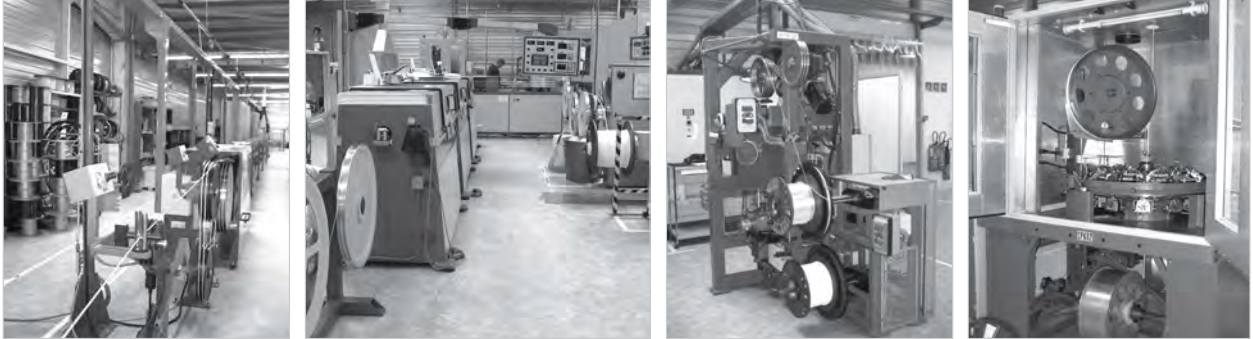

Requirements for designing a custom cable-assembly

Start with identifying the needed components and the required information for your cable assembly:

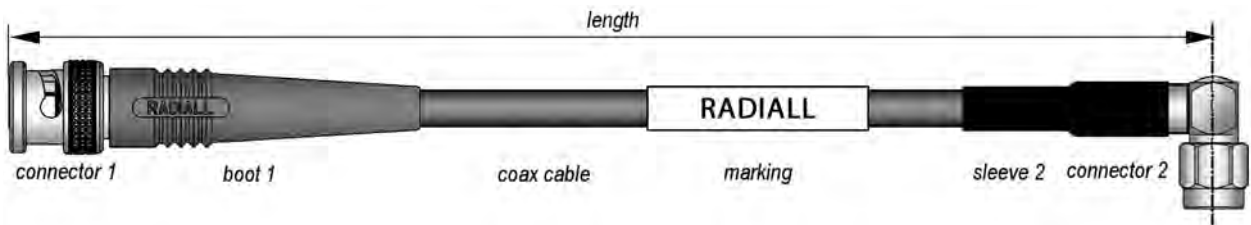

- Coaxial cable (p/n or description)
- Connector 1 (p/n or description)
- Optional boot 1 or heatshrink sleeve 1 (p/n or description)
- Connector 2 (p/n or description)
- Optional boot or sleeve 2 (p/n or description)
- Length: radiall standard = overall length (or please specify if length between reference planes)
+ length tolerance (radiall standard = $\pm 2\%$)
- Marking: Radiall standard = RADIALL + p/n + batch code (or please specify if different)
- Connectors orientation (if needed for right-angle or panel connectors)

If you need a pigtail, you will also need the following dimensions and information:

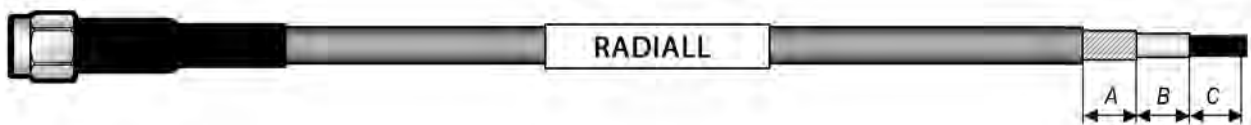

- Stripping A dimension
- Stripping B dimension
- Stripping C dimension
- Tinned inner conductor (if needed)
- Tinned braid (if needed)

Specify the right cable for your application

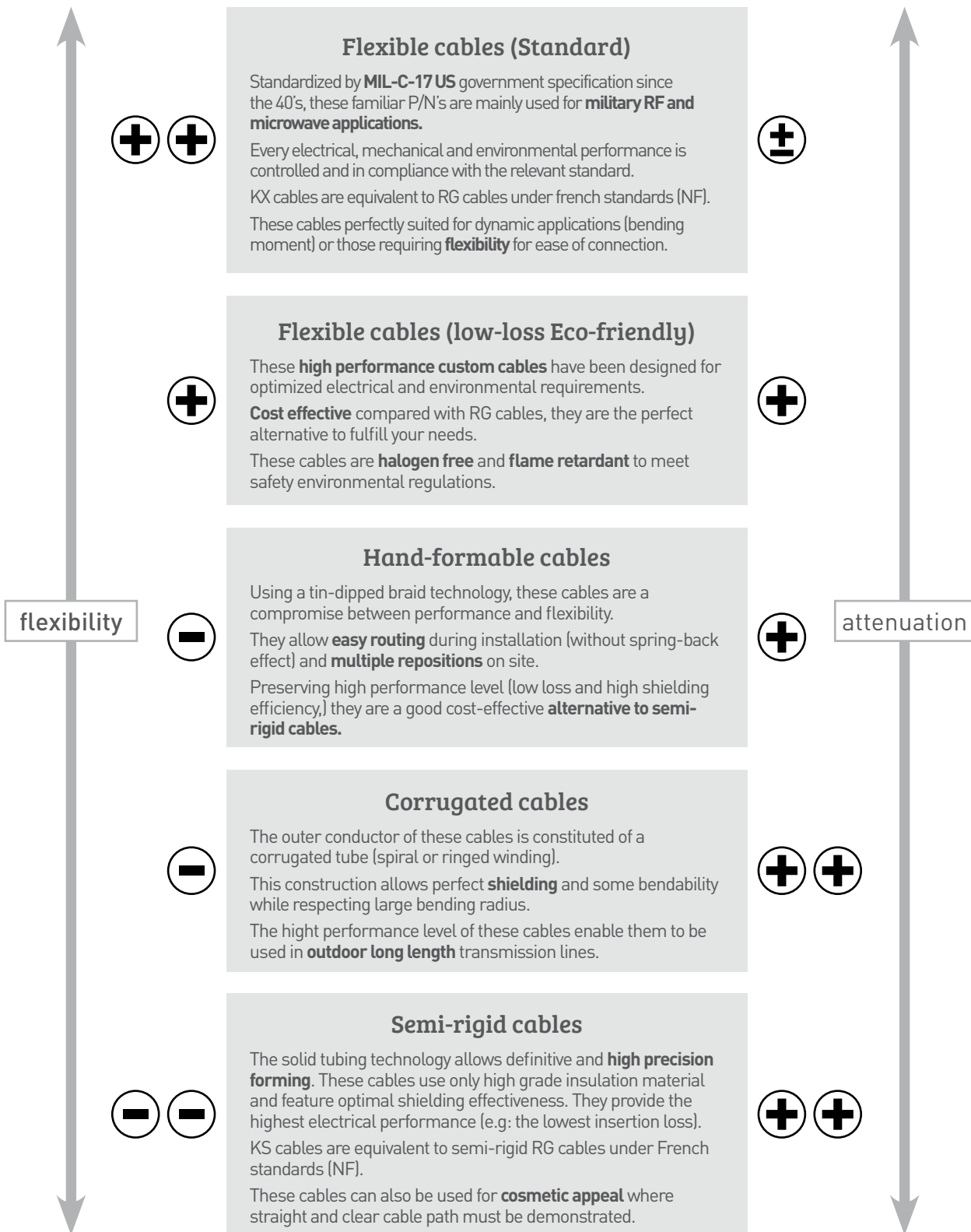

Finder guide - cables vs insertion loss

FLEXIBLE CABLES (STANDARD)

Cable group	Cable p/n	Cable type	1 GHz (VHF/UHF) dB/m dB/ft	2 GHz (band L) dB/m dB/ft	3 GHz (band S) dB/m dB/ft	6 GHz (band C) dB/m dB/ft	8 GHz (band C) dB/m dB/ft	12.4 GHz (band X) dB/m dB/ft
0.8/50 S	C291 042 066	132390 type	2.41/0.73	3.51/1.06	4.93/1.49			
1/50 S	C291 050 066	50 VMTX type	2.12/0.64	3.36/1.02	4.45/1.35			
1/75 S	C291 055 076	75 VMTX type	2.22/0.67	3.14/0.95				
2/50 S	C291 145 007/017	RG178/KX21	1.54/0.47	2.20/0.67	2.72/0.82			
	C291 140 087	RG178 non mag type	1.34/0.41	1.92/0.58	2.37/0.72			
2/50 D	C291 146 087	124416 type	1.34/0.41	1.92/0.58	2.37/0.72			
2/75 S	C291 147 060	296775 type	1.38/0.42	1.98/0.60	2.46/0.75			
2.6/50 S	C291 150 000/010	RG174/KX3B	1.07/0.32					
	C291 170 007/017	RG316/KX22A	0.86/0.26	1.24/0.38	1.54/0.47			
2.6/50 D	C291 185 067	RD316	0.86/0.26	1.24/0.38	1.54/0.47			
2.6/75 S	C291 210 007	RG179	0.95/0.29	1.37/0.41	1.70/0.51			
5/50 S	C291 305 000/010	RG58/KX15	0.67/0.20					
5/50 D	C291 320 007	RG142	0.44/0.13	0.65/0.20	0.81/0.25	1.22/0.37	1.45/0.44	1.90/0.58
	C291 330 000	RG223	0.46/0.14	0.67/0.20	0.85/0.26	1.27/0.38	1.51/0.46	1.97/0.60
	C291 324 007	RG400	0.52/0.16	0.76/0.23	0.95/0.29	1.42/0.43	1.68/0.51	2.19/0.66
	C291 322 017	KX23	0.48/0.14	0.70/0.21	0.89/0.27	1.35/0.41	1.61/0.49	
	C291 325 270	POWER142	0.41/0.12	0.58/0.18	0.72/0.22			
6/75 S	C291 360 000	RG59	0.44/0.13					
	C291 351 012	KX6A	0.48/0.15					
10/50 S	C291 510 000/010	RG213/KX4	0.24/0.07					
10/50 D	C291 511 007	RG393	0.23/0.07	0.35/0.11	0.45/0.14	0.71/0.21	0.86/0.26	1.07(11)/0.32(11)
11/50 D	C291 600 000/010	RG214/KX13	0.24/0.07	0.36/0.11	0.47/0.14	0.73/0.22	0.89/0.27	1.11(11)/0.33(11)
11/75 D	C291 610 000	RG216	0.32/0.10	0.48/0.14	0.60/0.18			

(11) = 11 GHz

FLEXIBLE CABLES (LOW-LOSS ECO-FRIENDLY)

(alternative to RG cables - in accordance with RoHS regulation)

Cable group	Cable p/n	Cable type	1 GHz (VHF/UHF) dB/m dB/ft	2 GHz (band L) dB/m dB/ft	3 GHz (band S) dB/m dB/ft	6 GHz (band C) dB/m dB/ft
2.6/50 S	C291 999 904	ECO316	0.76/0.23	1.09/0.33	1.34/0.41	
	C291 171 083	ECO316X	0.96/0.29	1.45/0.44	1.85/0.56	
2.6/50 D	C291 999 905	ECO316D	0.76/0.23	1.09/0.33	1.34/0.41	
	C291 217 020	ECO316DX	0.86/0.26	1.30/0.40	1.68/0.51	2.64/0.80
5/50 D	C291 325 290	ECO142	0.41/0.12	0.58/0.18	0.72/0.22	
	C291 320 180	ECO142X	0.54/0.16	0.83/0.25	1.07/0.32	1.70/0.51
6/50 D	C291 326 490	ECO230	0.28/0.08	0.40/0.12	0.50/0.15	0.59/0.18(4)
10/50 D	C291 491 060	ECO393	0.16/0.05	0.24/0.07	0.30/0.09	
	C291 512 020	ECO393X	0.29/0.09	0.47/0.14	0.64/0.19	1.11/0.34

(4) = 4 GHz

LOW-LOSS FLEXIBLE CABLES (AEP-xxxFR cables)

Cable group	Cable p/n	Cable type	1 GHz (VHF/UHF) dB/m dB/ft	2 GHz (band L) dB/m dB/ft	3 GHz (band S) dB/m dB/ft	6 GHz (band C) dB/m dB/ft
AEP-100FR	C291 327 060	LMR® 100	0.79/0.24	1.16/0.35	1.45/0.44	2.15/0.65
AEP-195FR	C291 327 010	LMR® 195	0.39/0.12	0.55/0.17	0.69/0.21	1.00/0.3
AEP-200FR	C291 327 020	LMR® 200	0.34/0.10	0.49/0.15	0.61/0.19	0.88/0.27
AEP-240FR	C291 327 030	LMR® 240	0.26/0.08	0.38/0.11	0.47/0.14	0.68/0.21
AEP-400FR	C291 327 040	LMR® 400	0.14/0.04	0.20/0.06	0.24/0.07	0.36/0.11
AEP-600FR	C291 327 050	LMR® 600	0.09/0.03	0.13/0.04	0.16/0.05	0.24/0.07

Finder guide - cables vs insertion loss

STANDARD FLEXIBLE HD CABLES

Cable group	Cable p/n	Cable type	1 GHz (VHF/UHF) dB/m dB/ft	2 GHz (band L) dB/m dB/ft	3 GHz (band S) dB/m dB/ft	4.5 GHz (band C) dB/m dB/ft
4.6/75 D	C291 333 039	HD 0.6/2.8 mini RG59 type	0.34/0.10	0.50/0.15	0.62/0.19	
6/75 D	C291 360 093	HD 0.8/3.7 RG59 type	0.25/0.07	0.35/0.11	0.44/0.13	0.54/0.16
7/75 D	C291 384 083	HD 1.0/4.8 RG6 type	0.19/0.06	0.28/0.08	0.35/0.11	0.44/0.13

CORRUGATED CABLES (spiral outer shielding)

Cable group	Cable p/n	Cable type	2 GHz (band L) dB/m dB/ft	3 GHz (band S) dB/m dB/ft	6 GHz (band C) dB/m dB/ft	8 GHz (band C) dB/m dB/ft	12.4 GHz (band X) dB/m dB/ft	18 GHz (band Ku) dB/m dB/ft	20 GHz (band Ku) dB/m dB/ft
Celiflex 1/4"	C291 993 170	HCF 1/4"-50 AlCu	0.27/0.08	0.34/0.10	0.51/0.15	0.60/0.18	0.78/0.24	0.99/0.30	1.06/0.32
Celiflex 3/8"	C291 996 170	HCF 3/8" CuH-50 AlCu	0.19/0.06	0.24/0.07	0.36/0.11	0.43/0.13	0.54(11.7)/0.16(11.7)		
Celiflex 1/2"	C291 994 170	HCF 1/2" CuH-50 AlCu	0.16/0.05	0.20/0.06	0.30/0.09	0.36/0.11	0.42(10)/0.13(11.7)		

(11.7) = 11.7 GHz (10) = 10 GHz

HAND-FORMABLE AND SEMI-RIGID CABLES

Cable group	Cable p/n	Cable type	2 GHz (band L) dB/m dB/ft	3 GHz (band S) dB/m dB/ft	6 GHz (band C) dB/m dB/ft	8 GHz (band C) dB/m dB/ft	12.4 GHz (band X) dB/m dB/ft	18 GHz (band Ku) dB/m dB/ft	20 GHz (band Ku) dB/m dB/ft
.047"	C291 855 001	SR copper	1.64/0.50	2.03/0.61	2.93/0.89	3.43/1.04	4.73/1.32	5.39/1.63	5.72/1.73
	C291 855 065	SR tinned copper	1.64/0.50	2.03/0.61	2.93/0.89	3.43/1.04	4.73/1.32	5.39/1.63	5.72/1.73
.085"	C291 844 065	Handformable unjacketed	0.97/0.29	1.21/0.37	1.78/0.54	2.10/0.64	2.71/0.82	3.39/1.03	3.62/1.10
	C291 850 001	SR RG405/KS1	0.94/0.29	1.18/0.36	1.73/0.53	2.05/0.62	2.64/0.80	3.31/1.00	3.53/1.07
	C291 850 005	SR tinned copper	0.94/0.29	1.18/0.36	1.73/0.53	2.05/0.62	2.64/0.80	3.31/1.00	3.53/1.07
	C291 851 001	SR non magnetic	0.94/0.29	1.18/0.36	1.73/0.53	2.05/0.62	2.64/0.80	3.31/1.00	3.53/1.07
	C291 844 187	SR aluminium	0.98/0.30	1.22/0.37	1.80/0.54	2.12/0.64	2.73/0.83	3.41/1.03	3.64/1.10
.141"	C291 864 065	Handformable unjacketed	0.57/0.17	0.72/0.22	1.09/0.33	1.30/0.39	1.71/0.52	2.18/0.66	2.34/0.71
	C291 866 378	Handformable FEP jacketed	0.63/0.19	0.80/0.24	1.20/0.36	1.42/0.43	1.87/0.57	2.37/0.72	2.54/0.77
	C291 860 001	SR RG402/KS2	0.50/0.15	0.64/0.19	0.97/0.30	1.17/0.35	1.55/0.47	1.99/0.60	2.14/0.65
	C291 862 005	SR tinned copper	0.50/0.15	0.64/0.19	0.97/0.30	1.17/0.35	1.55/0.47	1.99/0.60	2.14/0.65
	C291 861 066	SR silvered copper	0.50/0.15	0.64/0.19	0.97/0.30	1.17/0.35	1.55/0.47	1.99/0.60	2.14/0.65
	C291 861 061	SR non magnetic	0.50/0.15	0.64/0.19	0.97/0.30	1.17/0.35	1.55/0.47	1.99/0.60	2.14/0.65
	C291 864 187	SR aluminium	0.53/0.16	0.67/0.20	1.02/0.31	1.23/0.37	1.62/0.49	2.08/0.63	2.23/0.38
.250"	C291 870 001	SR RG401/KS3	0.31/0.09	0.41/0.12	0.64/0.20	0.79/0.24	1.08/0.33	1.42/0.43	1.54/0.47
	C291 874 187	SR aluminium	0.33/0.10	0.43/0.13	0.68/0.21	0.83/0.25	1.13/0.34	1.48/0.45	1.60/0.49

Flexible cable 0.8/50 S (132390 type)



P/N: C291042 066

APPLICATION NOTE

The very small outer diameter and bending moment of this cable allow very easy routing during installation.

Its very light weight makes it perfect to be used in all miniature and space saving applications.

The insulation and jacket materials allow this cable to be used in severe thermal conditions.

CONSTRUCTION / DIMENSIONS

	Material	mm	Inches
Center conductor	Solid SPC ⁽¹⁾	0.16	0.006
Dielectric	Solid PFA ⁽²⁾	0.50	0.020
Inner shield	SPC ⁽¹⁾ braid	0.70	0.028
Outer shield	-	-	-
Jacket	White FEP ⁽³⁾	0.83 max	0.033 max

ELECTRICAL CHARACTERISTICS

Characteristic impedance	50Ω ± 3Ω	
Operating frequency range	DC - 3 GHz	
Shielding effectiveness	40 dB	
Voltage withstanding	18 000 V rms	
Peak power	6 kW	
Capacitance	98.7 pF / m	29.9 pF / ft
Velocity of propagation	69 % (4.8 ns / m)	

MECHANICAL CHARACTERISTICS

Recommended minimum bending radius	4 mm	0.157 inch
Weight	1.8 g / m	0.001 lbs / ft

ENVIRONMENTAL CHARACTERISTICS

Operating temperature range	-50 / +200 °C	-58 / +392 °F
Fire resistance	yes (UL94V0)	
Halogen free	no	

FREQUENCY / ATTENUATION (typ.) / CW MAX POWER (sea level / 40 °C)

GHz	dB / m	dB / ft	Watts
0.1	0.64	0.19	45
0.2	0.88	0.27	34
0.3	1.90	0.58	28
0.4	1.28	0.39	22
0.5	1.48	0.45	20
1.0	2.41	0.73	14
1.5	3.03	0.92	12
2.0	3.51	1.06	10
2.5	4.20	1.27	9
3.0	4.93	1.49	8

⁽¹⁾ SPC = Silver Plated Copper

⁽²⁾ PFA = PerFluoroAlkoxy

⁽³⁾ FEP = Fluorinated Ethylene Propylene

Note:

Typical attenuation for a couple of connectors (dB) = 0.045 x √f (GHz)

Flexible cable 1/50 S (50 vmtx type)



P/N: C291050 066

APPLICATION NOTE

The very small outer diameter and bending moment of this cable allow very easy routing during installation.

Its very light weight makes it perfect to be used in all miniature and space saving applications.

The insulation and jacket materials allow this cable to be used in severe thermal conditions.

CONSTRUCTION / DIMENSIONS

	Material	mm	Inches
Center conductor	Solid SPC ⁽¹⁾	0.17	0.007
Dielectric	Solid PTFE ⁽²⁾	0.52	0.020
Inner shield	SPC ⁽¹⁾ braid	0.70	0.028
Outer shield	-	-	-
Jacket	White FEP ⁽³⁾	1.17	0.046

ELECTRICAL CHARACTERISTICS

Characteristic impedance	50Ω ± 5Ω	
Operating frequency range	DC - 3 GHz	
Shielding effectiveness	40 dB	
Voltage withstanding	19 000 V rms	
Peak power	7 kW	
Capacitance	94 pF / m	28.5 pF / ft
Velocity of propagation	69 % (4.8 ns / m)	

MECHANICAL CHARACTERISTICS

Recommended minimum bending radius	6 mm	0.236 inch
Weight	3 g / m	0.002 lbs / ft

ENVIRONMENTAL CHARACTERISTICS

Operating temperature range	-90 / +200 °C	-130 / +392 °F
Fire resistance	yes (UL94V0)	
Halogen free	no	

FREQUENCY / ATTENUATION (typ.) / CW MAX POWER (sea level / 40 °C)

GHz	dB / m	dB / ft	Watts
0.1	0.54	0.16	82
0.2	0.80	0.24	58
0.3	1.01	0.31	45
0.4	1.20	0.36	39
0.5	1.37	0.42	34
1.0	2.12	0.64	25
1.5	2.76	0.84	21
2.0	3.36	1.02	17
2.5	3.91	1.19	15
3.0	4.45	1.35	14
Attenuation calculation (dB/m)	[1.51 x √f (GHz)] + [0.61 x f (GHz)]		

⁽¹⁾ SPC = Silver Plated Copper

⁽²⁾ PTFE = PolyTetraFluoroEthylene

⁽³⁾ FEP = Fluorinated Ethylene Propylene

Flexible cable 1/75 S (75 vmtx type)



P/N: C291055 076

APPLICATION NOTE

Due to its 75 ohms characteristic impedance, this cable is best suited for TV/Video applications. The very small outer diameter and bending moment allow very easy routing during installation. Its very light weight makes it perfect to be used in all miniature, space saving and dynamic applications. Suitable for severe thermal conditions.

CONSTRUCTION / DIMENSIONS

	Material	mm	Inches
Center conductor	Solid SPCCS ⁽¹⁾	0.10	0.004
Dielectric	Solid PTFE ⁽²⁾	0.57	0.022
Inner shield	SPC ⁽³⁾ braid	0.80	0.031
Outer shield	-	-	-
Jacket	White FEP ⁽⁴⁾	1.22	0.048

ELECTRICAL CHARACTERISTICS

Characteristic impedance	80Ω ± 8Ω	
Operating frequency range	DC - 2 GHz	
Shielding effectiveness	40 dB	
Voltage withstanding	2 600 V rms	
Peak power	0.9 kW	
Capacitance	60 pF / m	18.3 pF / ft
Velocity of propagation	69 % (4.8 ns / m)	

MECHANICAL CHARACTERISTICS

Recommended minimum bending radius	6.1 mm	0.240 inch
Weight	3 g / m	0.002 lbs / ft

ENVIRONMENTAL CHARACTERISTICS

Operating temperature range	-90 / +200 °C	-130 / +392 °F
Fire resistance	yes (UL94V0)	
Halogen free	no	

FREQUENCY / ATTENUATION (typ.) / CW MAX POWER (sea level / 40 °C)

GHz	dB / m	dB / ft	Watts
0.1	0.70	0.21	86
0.2	0.99	0.30	64
0.3	1.21	0.37	50
0.4	1.40	0.42	41
0.5	1.57	0.47	38
0.6	1.71	0.52	35
0.8	1.98	0.60	30
1.0	2.22	0.67	26
1.5	2.71	0.82	21
2.0	3.14	0.95	18
Attenuation calculation (dB/m)	[2.21 x √f GHz] + [0.005 x f GHz]		

⁽¹⁾ SPCCS = Silver Plated Copper covered steel

⁽²⁾ PTFE = PolyTetraFluoroEthylene

⁽³⁾ SPC = Silver Plated Copper

⁽⁴⁾ FEP = Fluorinated Ethylene Propylene

Note:

Typical attenuation for a couple of connectors (dB) = 0.045 x √f (GHz)

Flexible cable 2/50 S (RG178 - KX21A)



P/N: C291 145 007

(MIL-C-17/93-RG178)

P/N: C291 145 017

(NF-C-93/550-KX21A)

APPLICATION NOTE

Due to its small diameter and its stranded inner conductor, RG 178 / KX21A is used for applications requiring high flexibility.

Its very low bending moment allows an easy routing during installation.

The insulation and jacket materials allow this cable to be used in severe thermal conditions.

CONSTRUCTION / DIMENSIONS

	Material	mm	Inches
Center conductor	Stranded SPCCS ⁽¹⁾	0.30	0.012
Dielectric	Solid PTFE ⁽²⁾	0.84	0.033
Inner shield	SPC ⁽³⁾ braid	1.30	0.051
Outer shield	-	-	-
Jacket	Brown FEP ⁽⁴⁾	1.78	0.07

ELECTRICAL CHARACTERISTICS

Characteristic impedance	50Ω ± 3Ω	
Operating frequency range	DC - 3 GHz	
Shielding effectiveness	40 dB	
Voltage withstanding	2 000 V rms	
Peak power	1 kW	
Capacitance	96 pF / m	29 pF / ft
Velocity of propagation	70 % (4.8 ns / m)	

MECHANICAL CHARACTERISTICS

Recommended minimum bending radius	7 mm	0.275 inch
Weight	8 g / m	0.0053 lbs / ft

ENVIRONMENTAL CHARACTERISTICS

Operating temperature range	-55 / +200 °C	-67 / +392 °F
Fire resistance	yes (CSA FT6 / IEC 332-2)	
Halogen free	no	

FREQUENCY / ATTENUATION (typ.) / CW MAX POWER (sea level / 25 °C)

GHz	dB / m	dB / ft	Watts
0.1	0.48	0.14	190
0.2	0.68	0.21	134
0.3	0.83	0.25	110
0.5	1.08	0.33	85
1.0	1.54	0.47	60
1.5	1.90	0.57	49
2.0	2.20	0.67	42
2.5	2.47	0.75	38
3.0	2.72	0.82	35
Attenuation calculation (dB/m)	[1.50 x √f GHz] + [0.04 x f GHz]		
Power calculation (W)	60 / √f GHz		

⁽¹⁾ SPCCS = Silver Plated Copper covered steel

⁽²⁾ PTFE = PolyTetraFluoroEthylene

⁽³⁾ SPC = Silver Plated Copper

⁽⁴⁾ FEP = Fluorinated Ethylene Propylene

Flexible cable 2/50 S (non magnetic RG178 type)



P/N: C291 140 087
(MIL-C-17/93-RG178)

APPLICATION NOTE

Based on MIL-C17/93 US standard, this cable is used where non magnetic is required.
In addition the solid inner conductor allows reduced attenuation in comparison with standard RG178.
The insulation and jacket materials allow this cable to be used in severe thermal conditions.

CONSTRUCTION / DIMENSIONS

	Material	mm	Inches
Center conductor	Solid SPC ⁽¹⁾	0.29	0.0114
Dielectric	Solid PTFE ⁽²⁾	0.84	0.033
Inner shield	SPC ⁽¹⁾ braid	1.30	0.051
Outer shield	-	-	-
Jacket	Brown FEP ⁽³⁾	1.80	0.071

ELECTRICAL CHARACTERISTICS

Characteristic impedance	50Ω ± 2Ω	
Operating frequency range	DC - 3 GHz	
Shielding effectiveness	40 dB	
Voltage withstanding	2 000 V rms	
Peak power	1 kW	
Capacitance	100 pF / m	30 pF / ft
Velocity of propagation	70 % (4.8 ns / m)	

MECHANICAL CHARACTERISTICS

Recommended minimum bending radius	9 mm	0.354 inch
Weight	8 g / m	0.0053 lbs / ft

ENVIRONMENTAL CHARACTERISTICS

Operating temperature range	-55 / +200 °C	-67 / +392 °F
Fire resistance	yes (CSA FT6 / IEC 332-2)	
Halogen free	no	

FREQUENCY / ATTENUATION (typ.) / CW MAX POWER (sea level / 25 °C)

GHz	dB / m	dB / ft	Watts
0.1	0.42	0.13	253
0.2	0.59	0.18	179
0.3	0.72	0.22	146
0.5	0.94	0.28	113
1.0	1.34	0.41	80
1.5	1.65	0.50	65
2.0	1.92	0.58	57
2.5	2.16	0.65	51
3.0	2.37	0.72	46
Attenuation calculation (dB/m)	(1.30 x √f GHz) + (0.04 x f GHz)		
Power calculation (W)	80 / √f GHz		

⁽¹⁾ SPC = Silver Plated Copper
⁽²⁾ PTFE = PolyTetraFluoroEthylene
⁽³⁾ FEP = Fluorinated Ethylene Propylene

Note:
Typical attenuation for a couple of connectors (dB) = 0.045 x √f (GHz)

Flexible cable 2/50 D (124416 type)



P/N: C291 146 087

APPLICATION NOTE

Due to its small diameter this cable will be used for applications requiring flexibility.
Its low bending moment allows an easy routing during installation.
The double braid provides a higher level of shielding in comparison with 2mm single braided cables.
In addition the solid inner conductor provides a very good attenuation level.
The insulation and jacket materials allow this cable to be used in severe thermal conditions.

CONSTRUCTION / DIMENSIONS

	Material	mm	Inches
Center conductor	Solid SPC ⁽¹⁾	0.29	0.011
Dielectric	Solid PTFE ⁽²⁾	0.84	0.033
Inner shield	SPC braid	1.27	0.050
Outer shield	SPC braid	1.60	0.063
Jacket	Brown FEP ⁽³⁾	2.10	0.083

ELECTRICAL CHARACTERISTICS

Characteristic impedance	50Ω ± 2Ω	
Operating frequency range	DC - 3 GHz	
Shielding effectiveness	80 dB	
Voltage withstanding	3 000 V rms	
Peak power	1.8 kW	
Capacitance	105 pF / m	32 pF / ft
Velocity of propagation	69 % (4.8 ns / m)	

MECHANICAL CHARACTERISTICS

Recommended minimum bending radius	12.5 mm	0.49 inch
Weight	12.5 g / m	0.0083 lbs / ft

ENVIRONMENTAL CHARACTERISTICS

Operating temperature range	-90 / +200 °C	-130 / +392 °F
Fire resistance	yes (UL94V0)	
Halogen free	no	

FREQUENCY / ATTENUATION (typ.) / CW MAX POWER (sea level / 40 °C)

GHz	dB / m	dB / ft	Watts
0.1	0.42	0.13	253
0.2	0.59	0.18	179
0.3	0.72	0.22	146
0.5	0.94	0.28	113
1.0	1.34	0.41	80
1.5	1.65	0.50	65
2.0	1.92	0.58	57
2.5	2.16	0.65	51
3.0	2.37	0.72	46
Attenuation calculation (dB/m)	(1.30 x √f GHz) + (0.04 x f GHz)		
Power calculation (W)	80 / √f GHz		

⁽¹⁾ SPC = Silver Plated Copper
⁽²⁾ PTFE = PolyTetraFluoroEthylene
⁽³⁾ FEP = Fluorinated Ethylene Propylene

Flexible cable 2/75 S (296775 type)



P/N: C291 147 060

APPLICATION NOTE

Due to its 75 ohms characteristic impedance, this cable is best suited for TV/Video and networks applications. Its small diameter and light weight make it perfect to be used in all miniature, space saving and dynamic applications.

CONSTRUCTION / DIMENSIONS

	Material	mm	Inches
Center conductor	Solid SPCCS ⁽¹⁾	0.17	0.007
Dielectric	Solid PE ⁽²⁾	1.00	0.039
Inner shield	SPC ⁽³⁾ braid	1.32	0.052
Outer shield	-	-	-
Jacket	Black LSZH PE ⁽⁴⁾	1.90	0.075

ELECTRICAL CHARACTERISTICS

Characteristic impedance	75Ω ± 5Ω	
Operating frequency range	DC - 3 GHz	
Shielding effectiveness	50 dB min	
Voltage withstanding	8 000 V rms	
Peak power	400 W	
Capacitance	67 pF / m	20.1 pF / ft
Velocity of propagation	66 % [5 ns / m]	

MECHANICAL CHARACTERISTICS

Recommended minimum bending radius	10 mm	0.394 inch
Weight	6.6 g / m	0.0044 lbs / ft

ENVIRONMENTAL CHARACTERISTICS

Operating temperature range	-60 / +85 °C	-40 / +185 °F
Fire resistance	no	
Halogen free	yes (IEC 754-2)	

FREQUENCY / ATTENUATION (typ. / 25 °C) / CW MAX POWER (sea level / 40 °C)

GHz	dB / m	dB / ft	Watts
0.1	0.42	0.13	41
0.2	0.60	0.18	29
0.3	0.74	0.22	23
0.4	0.86	0.26	20
0.6	1.06	0.32	16
1.0	1.38	0.42	12
1.5	1.70	0.52	10
2.0	1.98	0.60	8
2.5	2.23	0.68	7
3.0	2.46	0.75	6
Attenuation calculation (dB/m)	[1.317 x √f GHz] + [0.06 x f GHz]		

⁽¹⁾ SPCCS = Silver Plated Copper covered steel

⁽²⁾ PE = PolyEthylene

⁽³⁾ SPC = Silver Plated Copper

⁽⁴⁾ LSZH PE = Low Smoke Zero Halogen PolyEthylene

Note:

Typical attenuation for a couple of connectors [dB] = 0.045 x √f [GHz]

Flexible cable 2.6/50 S (RG174 - KX3B)



P/N: C291 150 000

(MIL-C-17/119-RG174)

P/N: C291 150 010

(NF-C-93/550-KX3B)

APPLICATION NOTE

For cost savings in low frequency applications, RG174 may be used instead of RG316 when environmental conditions like operating temperature allow it.

This cable is compatible with a large range of connector series.

Cost effective solution

CONSTRUCTION / DIMENSIONS

	Material	mm	Inches
Center conductor	Stranded CCS ⁽¹⁾	0.48	0.019
Dielectric	Solid PE ⁽²⁾	1.52	0.060
Inner shield	TC ⁽³⁾ braid	2.21	0.087
Outer shield	-	-	-
Jacket	Black PVC ⁽⁴⁾	2.79	0.110

ELECTRICAL CHARACTERISTICS

Characteristic impedance	50Ω ± 2Ω	
Operating frequency range	DC - 1 GHz	
Shielding effectiveness	40 dB	
Voltage withstanding	2 000 V rms	
Peak power	1.4 kW	
Capacitance	97.5 pF / m	29.5 pF / ft
Velocity of propagation	66 % [5 ns / m]	

MECHANICAL CHARACTERISTICS

Recommended minimum bending radius	10 mm	0.394 inch
Weight	13 g / m	0.0088 lbs / ft

ENVIRONMENTAL CHARACTERISTICS

Operating temperature range	-40 / +85 °C	-40 / +185 °F
Fire resistance	no	
Halogen free	no	

FREQUENCY / ATTENUATION (typ.) / CW MAX POWER (sea level / 25 °C)

GHz	dB / m	dB / ft	Watts
0.05	0.23	0.07	72
0.1	0.33	0.10	51
0.2	0.47	0.14	36
0.3	0.58	0.17	29
0.5	0.75	0.23	23
0.6	0.82	0.25	21
0.7	0.89	0.27	19
0.8	0.95	0.29	18
1.0	1.07	0.32	16
Attenuation calculation (dB/m)	[1.03 x √f GHz] + [0.04 x f GHz]		
Power calculation (W)	16 / √f GHz		

⁽¹⁾ CCS = Copper Covered Steel

⁽²⁾ PE = PolyEthylene

⁽³⁾ TC = Tinned Copper

⁽⁴⁾ PVC = PolyVinyl Chloride

Flexible cable 2.6/50 S (RG316 - KX22A)



P/N: C291 170 007
(MIL-C-17/113-RG316)

P/N: C291 170 017
(NF-C-93/550-KX22A)

APPLICATION NOTE

RG316 is one of the most popular RG cables. This cable has good flexibility and better attenuation than RG174. Suitable for severe thermal conditions, this cable is compatible with a large range of connector series.

CONSTRUCTION / DIMENSIONS

	Material	mm	Inches
Center conductor	Stranded SPCCS ⁽¹⁾	0.53	0.021
Dielectric	Solid PTFE ⁽²⁾	1.52	0.060
Inner shield	SPC ⁽³⁾ braid	1.98	0.078
Outer shield	-	-	-
Jacket	Brown FEP ⁽⁴⁾	2.49	0.098

ELECTRICAL CHARACTERISTICS

Characteristic impedance	50Ω ± 2Ω	
Operating frequency range	DC - 3 GHz	
Shielding effectiveness	40 dB	
Voltage withstanding	2 000 V rms	
Peak power	1.8 kW	
Capacitance	96 pF / m	29 pF / ft
Velocity of propagation	70 % (4.8 ns / m)	

MECHANICAL CHARACTERISTICS

Recommended minimum bending radius	10 mm	0.394 inch
Weight	17 g / m	0.0110 lbs / ft

ENVIRONMENTAL CHARACTERISTICS

Operating temperature range	-55 / +200 °C	-67 / +392 °F
Fire resistance	yes (CSA FT6 / IEC 332-2)	
Halogen free	no	

FREQUENCY / ATTENUATION (typ.) / CW MAX POWER (sea level / 25 °C)

GHz	dB / m	dB / ft	Watts
0.1	0.26	0.08	411
0.2	0.37	0.11	291
0.3	0.46	0.14	237
0.5	0.60	0.18	184
1.0	0.86	0.26	130
1.5	1.06	0.32	106
2.0	1.24	0.38	92
2.5	1.40	0.42	82
3.0	1.54	0.47	75
Attenuation calculation (dB/m)	[0.82 x √f GHz] + [0.04 x f GHz]		
Power calculation (W)	130 / √f GHz		

⁽¹⁾ SPCCS = Silver Plated Copper covered steel

⁽²⁾ PTFE = PolyTetraFluoroEthylene

⁽³⁾ SPC = Silver Plated Copper

⁽⁴⁾ FEP = Fluorinated Ethylene Propylene

Note:

Typical attenuation for a couple of connectors (dB) = 0.045 x √f (GHz)

Flexible cable 2.6/50 D (RD316)



P/N: C291 185 067

APPLICATION NOTE

Based on the RG 316 construction, RD316 has an outer shield braid which allows higher screening effectiveness and better mechanical resistance. Suitable for severe thermal conditions, this cable is compatible with a large range of connector series.

CONSTRUCTION / DIMENSIONS

	Material	mm	Inches
Center conductor	Stranded SPC ⁽¹⁾	0.53	0.021
Dielectric	Solid PTFE ⁽²⁾	1.52	0.060
Inner shield	SPC ⁽¹⁾ braid	1.90	0.075
Outer shield	SPC ⁽¹⁾ braid	2.30	0.091
Jacket	Brown FEP ⁽³⁾	2.80	0.110

ELECTRICAL CHARACTERISTICS

Characteristic impedance	50Ω ± 2Ω	
Operating frequency range	DC - 3 GHz	
Shielding effectiveness	60 dB	
Voltage withstanding	2 000 V rms	
Peak power	1.8 kW	
Capacitance	96 pF / m	29 pF / ft
Velocity of propagation	70 % (4.8 ns / m)	

MECHANICAL CHARACTERISTICS

Recommended minimum bending radius	15 mm	0.590 inch
Weight	27 g / m	0.0181 lbs / ft

ENVIRONMENTAL CHARACTERISTICS

Operating temperature range	-55 / +200 °C	-67 / +392 °F
Fire resistance	yes (CSA FT6 / IEC 332-2)	
Halogen free	no	

FREQUENCY / ATTENUATION (typ.) / CW MAX POWER (sea level / 25 °C)

GHz	dB / m	dB / ft	Watts
0.1	0.26	0.08	411
0.2	0.37	0.11	291
0.3	0.46	0.14	237
0.5	0.60	0.18	184
1.0	0.86	0.26	130
1.5	1.06	0.32	106
2.0	1.24	0.38	92
2.5	1.40	0.42	82
3.0	1.54	0.47	75
Attenuation calculation (dB/m)	[0.82 x √f GHz] + [0.04 x f GHz]		
Power calculation (W)	130 / √f GHz		

⁽¹⁾ SPC = Silver Plated Copper

⁽²⁾ PTFE = PolyTetraFluoroEthylene

⁽³⁾ FEP = Fluorinated Ethylene Propylene

Flexible cable 2.6/75 S (RG179)



**P/N: C291 210 007
(MIL-C-17/94-RG179)**

APPLICATION NOTE

Due to its 75 ohms characteristic impedance, RG179 is dedicated to TV/Video application.
Its small internal stranded inner conductor diameter allows high flexibility for easy routing.
Suitable for severe thermal conditions.

CONSTRUCTION / DIMENSIONS

	Material	mm	Inches
Center conductor	Stranded SPCCS ⁽¹⁾	0.30	0.012
Dielectric	Solid PTFE ⁽²⁾	1.60	0.063
Inner shield	SPC ⁽³⁾ braid	2.00	0.079
Outer shield	-	-	-
Jacket	Brown FEP ⁽⁴⁾	2.54	0.100

ELECTRICAL CHARACTERISTICS

Characteristic impedance	75Ω ± 3Ω	
Operating frequency range	DC - 3 GHz	
Shielding effectiveness	40 dB	
Voltage withstanding	2 000 V rms	
Peak power	1.6 kW	
Capacitance	69 pF / m	21 pF / ft
Velocity of propagation	70 % (4.8 ns / m)	

MECHANICAL CHARACTERISTICS

Recommended minimum bending radius	10 mm	0.400 inch
Weight	14.5 g / m	0.0097 lbs / ft

ENVIRONMENTAL CHARACTERISTICS

Operating temperature range	-55 / +200 °C	-67 / +392 °F
Fire resistance	yes (CSA FT6 / IEC 332-2)	
Halogen free	no	

**FREQUENCY / ATTENUATION (typ.) /
CW MAX POWER (sea level / 25 °C)**

GHz	dB / m	dB / ft	Watts
0.1	0.29	0.09	791
0.2	0.41	0.13	559
0.3	0.51	0.15	456
0.5	0.66	0.20	354
1.0	0.95	0.29	250
1.5	1.17	0.36	204
2.0	1.37	0.41	117
2.5	1.54	0.47	158
3.0	1.70	0.51	144
Attenuation calculation (dB/m)	[0.91 x √f GHz] + [0.04 x f GHz]		
Power calculation (W)	250 / √f GHz		

⁽¹⁾ SPCCS = Silver Plated Copper Covered Steel
⁽²⁾ PTFE = PolyTetraFluoroEthylene
⁽³⁾ SPC = Silver Plated Copper
⁽⁴⁾ FEP = Fluorinated Ethylene Propylene

Note:

Typical attenuation for a couple of connectors (dB) = 0.045 x √f (GHz)

Flexible cable 4.6/75 D (HD 0.6/2.8 - mini RG59 type)



P/N: C291 333 039

APPLICATION NOTE

Due to its 75 ohms characteristic impedance, this cable is dedicated to HDTV/Video applications.

CONSTRUCTION / DIMENSIONS

	Material	mm	Inches
Center conductor	Solid BC ⁽¹⁾	0.60	0.024
Dielectric	Foam PE ⁽²⁾	2.80	0.110
Inner shield	Triplex tape Al ⁽³⁾ /PES ⁽⁴⁾ /Al	2.90	0.114
Outer shield	TC ⁽⁵⁾ braid	3.30	0.130
Jacket	Purple LSZH PE ⁽⁶⁾	4.60	0.181

ELECTRICAL CHARACTERISTICS

Characteristic impedance	75Ω ± 3Ω	
Operating frequency range	DC - 3 GHz	
Shielding effectiveness	-	
Voltage withstanding	1 500 V rms	
Peak power	-	
Capacitance	56 pF / m	17.07 pF / ft
Velocity of propagation	78 % (4.3 ns / m)	

MECHANICAL CHARACTERISTICS

Recommended minimum bending radius	37 mm	1.46 inch
Weight	24 g / m	0.0161 lbs / ft

ENVIRONMENTAL CHARACTERISTICS

Operating temperature range	-20 / +70 °C	-4 / +158 °F
Fire resistance	yes (IEC 60332-1)	
Halogen free	yes (IEC 60754-1 & -2)	

**FREQUENCY / ATTENUATION (typ.) /
CW MAX POWER (sea level / 25 °C)**

GHz	dB / m	dB / ft	Watts
0.05	0.073	0.022	-
0.1	0.103	0.031	-
0.5	0.238	0.072	-
0.8	0.305	0.092	-
1.0	0.343	0.104	-
1.5	0.426	0.129	-
2.0	0.499	0.151	-
2.5	0.563	0.171	-
3.0	0.623	0.189	-
Attenuation calculation (dB/m)	[0.32 x √f GHz] + [0.023 x f GHz]		

⁽¹⁾ BC = Bare Copper
⁽²⁾ PE = PolyEthylene
⁽³⁾ Al = Aluminum
⁽⁴⁾ PES = PolyESter
⁽⁵⁾ TC = Tinned Copper
⁽⁶⁾ LSZH PE = Low Smoke Zero Halogen PolyEthylene

Flexible cable 5/50 S (RG58 - KX15)



**P/N: C291 305 000
(MIL-C-17/28-RG58)**

**P/N: C291 305 010
(NF-C-93/550-KX15)**

APPLICATION NOTE

RG58 is one of the most popular RG cables. Due to its construction and raw material construction, RG58 / KX15 is designed to perform the same as 5/50 cables (RG142, RG223, EC0142). This very flexible cable can be considered for applications requiring low electrical performance and reduced cost.

CONSTRUCTION / DIMENSIONS

	Material	mm	Inches
Center conductor	Stranded TC ⁽¹⁾	0.90	0.035
Dielectric	Solid PE ⁽²⁾	2.95	0.116
Inner shield	TC ⁽¹⁾ braid	3.66	0.144
Outer shield	-	-	-
Jacket	Black PVC ⁽³⁾	4.95	0.195

ELECTRICAL CHARACTERISTICS

Characteristic impedance	50Ω ± 2Ω	
Operating frequency range	DC - 1 GHz	
Shielding effectiveness	40 dB	
Voltage withstanding	5 000 V rms	
Peak power	2.6 kW	
Capacitance	96 pF / m	29 pF / ft
Velocity of propagation	66 % [5 ns / m]	

MECHANICAL CHARACTERISTICS

Recommended minimum bending radius	20 mm	0.787 inch
Weight	35 g / m	0.0234 lbs / ft

ENVIRONMENTAL CHARACTERISTICS

Operating temperature range	-40 / +85 °C	-40 / +185 °F
Fire resistance	no	
Halogen free	no	

FREQUENCY / ATTENUATION (typ.) / CW MAX POWER (sea level / 25 °C)

GHz	dB / m	dB / ft	Watts
0.05	0.14	0.04	246
0.1	0.20	0.06	174
0.2	0.29	0.09	123
0.3	0.36	0.11	100
0.5	0.47	0.14	78
0.6	0.51	0.16	71
0.7	0.56	0.17	66
0.8	0.60	0.18	61
1.0	0.67	0.20	55
Attenuation calculation (dB/m)	[0.63 x √f GHz] + [0.04 x f GHz]		
Power calculation (W)	55 / √f GHz		

⁽¹⁾ TC = Tinned Copper
⁽²⁾ PE = PolyEthylene
⁽³⁾ PVC = PolyVinyl Chloride

Note:
Typical attenuation for a couple of connectors (dB) = 0.045 x √f (GHz)

Flexible cable 5/50 D (RG142)



**P/N: C291 320 007
(MIL-C-17/158-RG142)**

APPLICATION NOTE

RG142 is one of the most popular RG cables. This cable offers a compromise between flexibility and electrical performances. RG142 will be selected among other 5/50 RG's for applications requiring high frequency range and low attenuation. Suitable for severe thermal conditions.

CONSTRUCTION / DIMENSIONS

	Material	mm	Inches
Center conductor	Solid SPCCS ⁽¹⁾	0.94	0.037
Dielectric	Solid PTFE ⁽²⁾	2.95	0.116
Inner shield	SPC ⁽³⁾ braid	-	-
Outer shield	SPC ⁽³⁾ braid	4.19	0.165
Jacket	Brown FEP ⁽⁴⁾	4.95	0.195

ELECTRICAL CHARACTERISTICS

Characteristic impedance	50Ω ± 2Ω	
Operating frequency range	DC - 12.4 GHz	
Shielding effectiveness	65 dB (DC - 3GHz)	
Voltage withstanding	5 000 V rms	
Peak power	3.4 kW	
Capacitance	97 pF / m	29.3 pF / ft
Velocity of propagation	70 % [4.8 ns / m]	

MECHANICAL CHARACTERISTICS

Recommended minimum bending radius	25 mm	0.984 inch
Weight	64 g / m	0.043 lbs / ft

ENVIRONMENTAL CHARACTERISTICS

Operating temperature range	-55 / +200 °C	-67 / +392 °F
Fire resistance	yes (CSA FT6 / IEC 332-2)	
Halogen free	no	

FREQUENCY / ATTENUATION (typ.) / CW MAX POWER (sea level / 25 °C)

GHz	dB / m	dB / ft	Watts
0.5	0.30	0.09	665
1.0	0.44	0.13	470
1.5	0.55	0.17	384
2.0	0.65	0.20	332
3.0	0.81	0.25	271
6.0	1.22	0.37	192
8.0	1.45	0.44	166
10.0	1.66	0.50	149
12.4	1.90	0.58	133
Attenuation calculation (dB/m)	[0.40 x √f GHz] + [0.04 x f GHz]		
Power calculation (W)	470 / √f GHz		

⁽¹⁾ SPCCS = Silver Plated Copper Covered Steel
⁽²⁾ PTFE = PolyTetraFluoroEthylene
⁽³⁾ SPC = Silver Plated Copper
⁽⁴⁾ FEP = Fluorinated Ethylene Propylene

Flexible cable 5/50 D (RG223)



**P/N: C291 330 000
(MIL-C-17/84-RG223)**

APPLICATION NOTE

RG223 is one of the most popular RG cables. This cable is a good compromise between flexibility and electrical performance. RG223 can be used instead of RG142 to reduce cost in applications that do not require high temperature resistance.

CONSTRUCTION / DIMENSIONS

	Material	mm	Inches
Center conductor	Solid SPC ⁽¹⁾	0.89	0.035
Dielectric	Solid PE ⁽²⁾	2.95	0.116
Inner shield	SPC ⁽¹⁾ braid	-	-
Outer shield	SPC ⁽¹⁾ braid	4.19	0.165
Jacket	Black PVC ⁽³⁾	5.38	0.212

ELECTRICAL CHARACTERISTICS

Characteristic impedance	50Ω ± 2Ω	
Operating frequency range	DC - 12.4 GHz	
Shielding effectiveness	65 dB (DC - 3 GHz)	
Voltage withstanding	5 000 V rms	
Peak power	2.6 kW	
Capacitance	96 pF / m	29 pF / ft
Velocity of propagation	66 % [5 ns / m]	

MECHANICAL CHARACTERISTICS

Recommended minimum bending radius	25 mm	0.984 inch
Weight	55 g / m	0.0370 lbs / ft

ENVIRONMENTAL CHARACTERISTICS

Operating temperature range	-40 / +85 °C	-40 / +185 °F
Fire resistance	no	
Halogen free	no	

FREQUENCY / ATTENUATION (typ.) / CW MAX POWER (sea level / 25 °C)

GHz	dB / m	dB / ft	Watts
0.5	0.32	0.10	71
1.0	0.46	0.14	50
1.5	0.57	0.17	41
2.0	0.67	0.20	35
3.0	0.85	0.26	29
6.0	1.27	0.38	20
8.0	1.51	0.46	18
10.0	1.73	0.52	16
12.4	1.97	0.60	14
Attenuation calculation (dB/m)	[0.42 x √f GHz] + [0.04 x f GHz]		
Power calculation (W)	50 / √f GHz		

⁽¹⁾ SPC = Silver Plated Copper

⁽²⁾ PE = PolyEthylene

⁽³⁾ PVC = PolyVinyl Chloride

Note:

Typical attenuation for a couple of connectors (dB) = 0.045 x √f (GHz)

Flexible cable 5/50 D (RG400)



**P/N: C291 324 007
(MIL-C-17/128-RG400)**

APPLICATION NOTE

Due to its stranded inner conductor, RG 400 is much more flexible than RG142 and RG223. This cable can be used instead of equivalent RG's for specific applications requiring high flexibility. Suitable for severe thermal conditions.

CONSTRUCTION / DIMENSIONS

	Material	mm	Inches
Center conductor	Stranded SPC ⁽¹⁾	0.98	0.039
Dielectric	Solid PTFE ⁽²⁾	2.95	0.116
Inner shield	SPC ⁽¹⁾ braid	-	-
Outer shield	SPC ⁽¹⁾ braid	4.19	0.165
Jacket	Brown FEP ⁽³⁾	4.95	0.195

ELECTRICAL CHARACTERISTICS

Characteristic impedance	50Ω ± 2Ω	
Operating frequency range	DC - 12.4 GHz	
Shielding effectiveness	65 dB (DC - 3 GHz)	
Voltage withstanding	5 000 V rms	
Peak power	3.4 kW	
Capacitance	97 pF / m	29.3 pF / ft
Velocity of propagation	70 % [4.8 ns / m]	

MECHANICAL CHARACTERISTICS

Recommended minimum bending radius	20 mm	0.79 inch
Weight	66 g / m	0.0442 lbs / ft

ENVIRONMENTAL CHARACTERISTICS

Operating temperature range	-55 / +200 °C	-67 / +392 °F
Fire resistance	yes (CSA FT6 / IEC 332-2)	
Halogen free	no	

FREQUENCY / ATTENUATION (typ.) / CW MAX POWER (sea level / 25 °C)

GHz	dB / m	dB / ft	Watts
0.5	0.36	0.11	665
1.0	0.52	0.16	470
1.5	0.65	0.20	384
2.0	0.76	0.23	332
3.0	0.95	0.29	271
6.0	1.42	0.43	192
8.0	1.68	0.51	166
10.0	1.92	0.58	149
12.4	2.19	0.66	133
Attenuation calculation (dB/m)	[0.48 x √f GHz] + [0.04 x f GHz]		
Power calculation (W)	470 / √f GHz		

⁽¹⁾ SPC = Silver Plated Copper

⁽²⁾ PTFE = PolyTetraFluoroEthylene

⁽³⁾ FEP = Fluorinated Ethylene Propylene

Flexible cable 5/50 D (KX23)



**P/N: C291 322 017
(NF-C-93/550-KX23)**

APPLICATION NOTE

Relevant standard: NF-C-93/550-KX23 (France)
 Due to its stranded inner conductor it is much more flexible than RG142 or RG223.
 This cable can be used instead of equivalent RG's for specific applications requiring high flexibility.
 Suitable for severe thermal conditions.

CONSTRUCTION / DIMENSIONS

	Material	mm	Inches
Center conductor	Stranded SPC ⁽¹⁾	0.92	0.036
Dielectric	Solid PTFE ⁽²⁾	2.95	0.116
Inner shield	SPC braid	-	-
Outer shield	SPC braid	4.34	0.171
Jacket	Translucent fiber glass	5.10	0.201

ELECTRICAL CHARACTERISTICS

Characteristic impedance	50Ω ± 2.5Ω	
Operating frequency range	DC - 8 GHz	
Shielding effectiveness	65 dB (DC - 3 GHz)	
Voltage withstanding	5 000 V rms	
Peak power	3 kW	
Capacitance	95 pF / m	28.8 pF / ft
Velocity of propagation	70 % [4.8 ns / m]	

MECHANICAL CHARACTERISTICS

Recommended minimum bending radius	30 mm	1.181 inch
Weight	70 g / m	0.0466 lbs / ft

ENVIRONMENTAL CHARACTERISTICS

Operating temperature range	-55 / +200 °C	-67 / +392 °F
Fire resistance	yes (IEC 60332-1)	
Halogen free	no	

FREQUENCY / ATTENUATION (typ. / 25 °C) / CW MAX POWER (sea level / 40 °C)

GHz	dB / m	dB / ft	Watts
0.5	0.33	0.10	375
1.0	0.48	0.14	260
1.5	0.60	0.18	210
2.0	0.70	0.21	180
2.5	0.80	0.24	160
3.0	0.89	0.27	146
4.0	1.05	0.32	126
5.0	1.20	0.37	112
6.0	1.35	0.41	102
8.0	1.61	0.49	88
Attenuation calculation (dB/m)	[0.427 x √f GHz] + [0.05 x f GHz]		

⁽¹⁾ SPC = Silver Plated Copper

⁽²⁾ PTFE = PolyTetraFluoroEthylene

Note:

Typical attenuation for a couple of connectors (dB) = 0.045 x √f (GHz)

Flexible cable 6/75 S (RG59)



**P/N: C291 360 000
(MIL-C-17/29-RG59)**

APPLICATION NOTE

Due to its 75 ohms characteristic impedance, RG59 is best suited for TV/Video application.
 Its solid inner conductor allows better attenuation than the equivalent KX solution (KX6).

CONSTRUCTION / DIMENSIONS

	Material	mm	Inches
Center conductor	Solid CCS ⁽¹⁾	0.57	0.022
Dielectric	Solid PE ⁽²⁾	3.71	0.146
Inner shield	Copper braid	4.50	0.177
Outer shield	-	-	-
Jacket	Black PVC ⁽³⁾	6.15	0.242

ELECTRICAL CHARACTERISTICS

Characteristic impedance	75Ω ± 3Ω	
Operating frequency range	DC - 1 GHz	
Shielding effectiveness	40 dB	
Voltage withstanding	7 000 V rms	
Peak power	2.7 kW	
Capacitance	60 pF / m	18.2 pF / ft
Velocity of propagation	66 % [5 ns / m]	

MECHANICAL CHARACTERISTICS

Recommended minimum bending radius	30 mm	1.18 inch
Weight	47 g / m	0.0315 lbs / ft

ENVIRONMENTAL CHARACTERISTICS

Operating temperature range	-40 / +85 °C	-40 / +185 °F
Fire resistance	no	
Halogen free	no	

FREQUENCY / ATTENUATION (typ.) / CW MAX POWER (sea level / 25 °C)

GHz	dB / m	dB / ft	Watts
0.05	0.09	0.03	335
0.1	0.13	0.04	237
0.2	0.19	0.06	168
0.3	0.23	0.07	137
0.5	0.30	0.09	106
0.6	0.33	0.10	97
0.7	0.36	0.11	90
0.8	0.39	0.12	84
1.0	0.44	0.13	75
Attenuation calculation (dB/m)	[0.40 x √f GHz] + [0.04 x f GHz]		
Power calculation (W)	75 / √f GHz		

⁽¹⁾ CCS = Copper Covered Steel

⁽²⁾ PE = PolyEthylene

⁽³⁾ PVC = PolyVinyl Chloride

Flexible cable 6/75 S (KX6A)



**P/N: C291 351 012
(NF-C-93/550-KX6)**

APPLICATION NOTE

Relevant standard: NF-C-93/550-KX6 (France)
Due to its stranded inner conductor, KX6 is much more flexible than RG59.
This cable is better suited instead of RG59 for specific applications requiring high flexibility.

Cost effective solution

CONSTRUCTION / DIMENSIONS

	Material	mm	Inches
Center conductor	Stranded copper	0.60	0.024
Dielectric	Solid PE ⁽¹⁾	3.70	0.146
Inner shield	Copper braid	4.50	0.177
Outer shield	-	-	-
Jacket	Green PVC ⁽²⁾	6.10	0.240

ELECTRICAL CHARACTERISTICS

Characteristic impedance	75Ω ± 3Ω	
Operating frequency range	DC - 1 GHz	
Shielding effectiveness	40 dB	
Voltage withstanding	7 000 V rms	
Peak power	2.7 kW	
Capacitance	63 pF / m	19 pF / ft
Velocity of propagation	66 % (5 ns / m)	

MECHANICAL CHARACTERISTICS

Recommended minimum bending radius	25 mm	0.98 inch
Weight	48 g / m	0.0320 lbs / ft

ENVIRONMENTAL CHARACTERISTICS

Operating temperature range	-40 / +85 °C	-40 / +185 °F
Fire resistance	no	
Halogen free	no	

FREQUENCY / ATTENUATION (typ.) / CW MAX POWER (sea level / 25 °C)

GHz	dB / m	dB / ft	Watts
0.05	0.10	0.03	300
0.1	0.14	0.04	212
0.2	0.20	0.06	150
0.3	0.25	0.08	122
0.5	0.33	0.10	95
0.6	0.36	0.11	86
0.7	0.40	0.12	80
0.8	0.43	0.13	75
1.0	0.48	0.15	67
Attenuation calculation (dB/m)	[0.44 x √f GHz] + [0.04 x f GHz]		
Power calculation (W)	67 / √f GHz		

⁽¹⁾ PE = PolyEthylene
⁽²⁾ PVC = PolyVinyl Chloride

Flexible cable 6/75 D (HD 0.8/3.7 - RG59 type)



P/N: C291 360 093

APPLICATION NOTE

Due to its 75 ohms characteristic impedance, this cable is best suited for HDTV/Video application.

CONSTRUCTION / DIMENSIONS

	Material	mm	Inches
Center conductor	Solid BC ⁽¹⁾	0.81	0.032
Dielectric	FHD PE ⁽²⁾	3.68	0.145
Inner shield	Al ⁽³⁾ tape	3.81	0.150
Outer shield	TC ⁽⁴⁾ braid	4.37	0.172
Jacket	Blue PVC ⁽⁵⁾	5.92	0.233

ELECTRICAL CHARACTERISTICS

Characteristic impedance	75Ω ± 1.5Ω	
Operating frequency range	DC - 4.5 GHz	
Shielding effectiveness	-	
Voltage withstanding	300 V rms	
Peak power	-	
Capacitance	53.5 pF / m	16.3 pF / ft
Velocity of propagation	83 % (4.0 ns / m)	

MECHANICAL CHARACTERISTICS

Recommended minimum bending radius	63.5 mm	2.5 inch
Weight	46 g / m	0.031 lbs / ft

ENVIRONMENTAL CHARACTERISTICS

Operating temperature range	-30 / +75 °C	-22 / +167 °F
Fire resistance	yes (UL1666 Vertical Shaft)	
Halogen free	no	

FREQUENCY / ATTENUATION (typ.) / CW MAX POWER (sea level / 25 °C)

GHz	dB / m	dB / ft	Watts
0.5	0.173	0.052	-
1.0	0.247	0.075	-
1.5	0.304	0.092	-
2.0	0.353	0.107	-
2.5	0.397	0.120	-
3.0	0.437	0.132	-
3.5	0.473	0.143	-
4.0	0.508	0.154	-
4.5	0.541	0.164	-
Attenuation calculation (dB/m)	[0.24 x √f GHz] + [0.007 x f GHz]		

⁽¹⁾ BC = Bare Copper
⁽²⁾ FHD PE = Foam High Density PolyEthylene
⁽³⁾ Al = Aluminum
⁽⁴⁾ TC = Tinned Copper
⁽⁵⁾ PVC = PolyVinyl Chloride

Note:
Typical attenuation for a couple of connectors (dB) = 0.045 x √f (GHz)

Flexible cable 7/75 D (HD 1.0/4.8 - RG6 type)



P/N: C291 384 083

APPLICATION NOTE

Due to its 75 ohms characteristic impedance, this cable is better suited for HDTV/Video application.

CONSTRUCTION / DIMENSIONS

	Material	mm	Inches
Center conductor	Solid BC ⁽¹⁾	1.02	0.040
Dielectric	FHD PE ⁽²⁾	4.56	0.180
Inner shield	Al ⁽³⁾ tape	4.70	0.185
Outer shield	TC ⁽⁴⁾ braid	5.26	0.207
Jacket	Blue PVC ⁽⁵⁾	6.95	0.274

ELECTRICAL CHARACTERISTICS

Characteristic impedance	75Ω ± 1.5Ω	
Operating frequency range	DC - 4.5 GHz	
Shielding effectiveness	-	
Voltage withstanding	300 V rms	
Peak power	-	
Capacitance	53.15 pF / m	16.2 pF / ft
Velocity of propagation	82 % [4.1 ns / m]	

MECHANICAL CHARACTERISTICS

Recommended minimum bending radius	69.85 mm	2.75 inch
Weight	59.5 g / m	0.04 lbs / ft

ENVIRONMENTAL CHARACTERISTICS

Operating temperature range	-30 / +75 °C	-22 / +167 °F
Fire resistance	yes [UL1666 Vertical Shaft]	
Halogen free	no	

FREQUENCY / ATTENUATION (typ.) / CW MAX POWER (sea level / 25 °C)

GHz	dB / m	dB / ft	Watts
0.5	0.134	0.040	-
1.0	0.193	0.058	-
1.5	0.240	0.073	-
2.0	0.281	0.085	-
2.5	0.318	0.096	-
3.0	0.352	0.107	-
3.5	0.384	0.116	-
4.0	0.414	0.125	-
4.5	0.443	0.134	-
Attenuation calculation (dB/m)	[0.179 x √f GHz] + [0.014 x f GHz]		

⁽¹⁾ BC = Bare Copper

⁽²⁾ FHD PE = Foam High Density PolyEthylene

⁽³⁾ Al = Aluminum

⁽⁴⁾ TC = Tinned Copper

⁽⁵⁾ PVC = PolyVinyl Chloride

Note:

Typical attenuation for a couple of connectors (dB) = 0.045 x √f (GHz)

Flexible cable 10/50 S (RG213 - KX4)



**P/N: C291 510 000
(MIL-C-17/74-RG213)**

**P/N: C291 510 010
(NF-C-93/550-KX4)**

APPLICATION NOTE

Due to its construction and raw material selection, RG213 is a cost effectiveness solution in the 10 mm cable range.

This cable may be considered for low frequency applications that do not require a high level of screening effectiveness.

Cost effective solution

CONSTRUCTION / DIMENSIONS

	Material	mm	Inches
Center conductor	Standed copper	2.26	0.089
Dielectric	Solid PE ⁽¹⁾	7.24	0.285
Inner shield	Copper braid	8.13	0.320
Outer shield	-	-	-
Jacket	Black PVC ⁽²⁾	10.30	0.406

ELECTRICAL CHARACTERISTICS

Characteristic impedance	50Ω ± 2Ω	
Operating frequency range	DC - 1 GHz	
Shielding effectiveness	40 dB	
Voltage withstanding	10 000 V rms	
Peak power	6.5 kW	
Capacitance	96 pF / m	29 pF / ft
Velocity of propagation	66 % [5 ns / m]	

MECHANICAL CHARACTERISTICS

Recommended minimum bending radius	40 mm	1.57 inch
Weight	148 g / m	0.0999 lbs / ft

ENVIRONMENTAL CHARACTERISTICS

Operating temperature range	-40 / +85 °C	-40 / +185 °F
Fire resistance	no	
Halogen free	no	

FREQUENCY / ATTENUATION (typ.) / CW MAX POWER (sea level / 25 °C)

GHz	dB / m	dB / ft	Watts
0.05	0.05	0.01	805
0.1	0.07	0.02	569
0.2	0.10	0.03	402
0.3	0.12	0.04	329
0.5	0.16	0.05	255
0.6	0.18	0.05	232
0.7	0.20	0.06	215
0.8	0.21	0.06	201
1.0	0.24	0.07	180
Attenuation calculation (dB/m)	[0.20 x √f GHz] + [0.04 x f GHz]		
Power calculation (W)	180 / √f GHz		

⁽¹⁾ PE = PolyEthylene

⁽²⁾ PVC = PolyVinyl Chloride

Flexible cable 10/50 D (RG393)



**P/N: C291 511 007
(MIL-C-17/174-RG393)**

APPLICATION NOTE

RG393 is one of the most popular RG cables.

This cable may be used for high frequency range and severe thermal conditions applications.

CONSTRUCTION / DIMENSIONS

	Material	mm	Inches
Center conductor	Stranded SPC ⁽¹⁾	2.39	0.094
Dielectric	Solid PTFE ⁽²⁾	7.24	0.285
Inner shield	SPC ⁽¹⁾ braid	-	-
Outer shield	SPC ⁽¹⁾ braid	8.90	0.350
Jacket	Brown FEP ⁽³⁾	9.91	0.390

ELECTRICAL CHARACTERISTICS

Characteristic impedance	50Ω ± 2Ω	
Operating frequency range	DC - 11 GHz	
Shielding effectiveness	65 dB (DC - 3 GHz)	
Voltage withstanding	10 000 V rms	
Peak power	8.3 kW	
Capacitance	96 pF / m	29 pF / ft
Velocity of propagation	70 % (4.8 ns / m)	

MECHANICAL CHARACTERISTICS

Recommended minimum bending radius	40 mm	1.57 inch
Weight	235 g / m	0.1567 lbs / ft

ENVIRONMENTAL CHARACTERISTICS

Operating temperature range	-55 / +200 °C	-67 / +392 °F
Fire resistance	yes (CSA FT6 / IEC 332-2)	
Halogen free	no	

**FREQUENCY / ATTENUATION (typ.) /
CW MAX POWER (sea level / 25 °C)**

GHz	dB / m	dB / ft	Watts
0.5	0.15	0.05	1 273
1.0	0.23	0.07	900
1.5	0.29	0.09	735
2.0	0.35	0.11	636
3.0	0.45	0.14	520
6.0	0.71	0.21	367
8.0	0.86	0.26	318
10.0	1.00	0.30	285
11.0	1.07	0.32	271
Attenuation calculation (dB/m)	[0.19 x √f GHz] + [0.04 x f GHz]		
Power calculation (W)	900 / √f GHz		

⁽¹⁾ SPC = Silver Plated Copper

⁽²⁾ PTFE = PolyTetraFluoroEthylene

⁽³⁾ FEP = Fluorinated Ethylene Propylene

Note:

Typical attenuation for a couple of connectors (dB) = 0.045 x √f (GHz)

Flexible cable 11/50 D (RG214 - KX13)



**P/N: C291 600 000
(MIL-C-17/75-RG214)**

**P/N: C291 600 010
(NF-C-93/550-KX13)**

APPLICATION NOTE

RG214 is one of the most popular RG cables.

To reduce cost when thermal conditions allow this cable may be used instead of RG393.

CONSTRUCTION / DIMENSIONS

	Material	mm	Inches
Center conductor	Stranded SPC ⁽¹⁾	2.25	0.089
Dielectric	Solid PE ⁽²⁾	7.24	0.285
Inner shield	SPC ⁽¹⁾ braid	-	-
Outer shield	SPC ⁽¹⁾ braid	8.89	0.350
Jacket	Black PVC ⁽³⁾	10.80	0.425

ELECTRICAL CHARACTERISTICS

Characteristic impedance	50Ω ± 2Ω	
Operating frequency range	DC - 11 GHz	
Shielding effectiveness	65 dB (DC - 3 GHz)	
Voltage withstanding	10 000 V rms	
Peak power	6.5 kW	
Capacitance	96 pF / m	29 pF / ft
Velocity of propagation	66 % (5 ns / m)	

MECHANICAL CHARACTERISTICS

Recommended minimum bending radius	40 mm	1.57 inch
Weight	174 g / m	0.1170 lbs / ft

ENVIRONMENTAL CHARACTERISTICS

Operating temperature range	-40 / +85 °C	-40 / +185 °F
Fire resistance	no	
Halogen free	no	

**FREQUENCY / ATTENUATION (typ.) /
CW MAX POWER (sea level / 25 °C)**

GHz	dB / m	dB / ft	Watts
0.5	0.16	0.05	255
1.0	0.24	0.07	180
1.5	0.30	0.09	147
2.0	0.36	0.11	127
3.0	0.47	0.14	104
6.0	0.73	0.22	73
8.0	0.89	0.27	64
10.0	1.03	0.31	57
11.0	1.10	0.33	54
Attenuation calculation (dB/m)	[0.20 x √f GHz] + [0.04 x F GHz]		
Power calculation (W)	180 / √f GHz		

⁽¹⁾ SPC = Silver Plated Copper

⁽²⁾ PE = PolyEthylene

⁽³⁾ PVC = PolyVinyl Chloride

Flexible cable 11/75 D (RG216)



**P/N: C291 610 000
(MIL-C-17/77-RG216)**

APPLICATION NOTE

Due to its 75 ohms characteristic impedance, RG 216 is better suited for TV/Video applications.

CONSTRUCTION / DIMENSIONS

	Material	mm	Inches
Center conductor	Stranded TC ⁽¹⁾	1.21	0.048
Dielectric	Solid PE ⁽²⁾	7.24	0.285
Inner shield	Copper braid	-	-
Outer shield	Copper braid	8.89	0.350
Jacket	Black PVC ⁽³⁾	10.80	0.425

ELECTRICAL CHARACTERISTICS

Characteristic impedance	75Ω ± 3Ω	
Operating frequency range	DC - 3 GHz	
Shielding effectiveness	65 dB	
Voltage withstanding	10 000 V rms	
Peak power	5.3 kW	
Capacitance	66 pF / m	20 pF / ft
Velocity of propagation	66 % (5 ns / m)	

MECHANICAL CHARACTERISTICS

Recommended minimum bending radius	50 mm	1.97 inch
Weight	165 g / m	0.1104 lbs / ft

ENVIRONMENTAL CHARACTERISTICS

Operating temperature range	-40 / +85 °C	-40 / +185 °F
Fire resistance	no	
Halogen free	no	

FREQUENCY / ATTENUATION (typ.) / CW MAX POWER (sea level / 25 °C)

GHz	dB / m	dB / ft	Watts
0.1	0.09	0.03	395
0.2	0.13	0.04	280
0.3	0.17	0.05	228
0.5	0.22	0.07	177
1.0	0.32	0.10	125
1.5	0.40	0.12	102
2.0	0.48	0.14	88
2.5	0.54	0.16	79
3.0	0.60	0.18	72
Attenuation calculation (dB/m)	[0.28 x √f GHz] + [0.04 x f GHz]		
Power calculation (W)	125 / √f GHz		

⁽¹⁾ TC = Tinned Copper
⁽²⁾ PE = PolyEthylene
⁽³⁾ PVC = PolyVinyl Chloride

Note:
Typical attenuation for a couple of connectors (dB) = 0.045 x √f (GHz)

Flexible cable 2.6/50 S (ECO316: alternative to RG316)



P/N: C291 999 904

APPLICATION NOTE

Designed by RADIALL, ECO316 is an advantageous alternative solution to RG316:

- **Advantageous in term of electrical performance:** its optimized construction allows better attenuation and screening effectiveness than RG316 and RG 174.
- **Environmental advantages:** halogen and sulphur free, this cable does not emit any toxic substance when submitted to fire. The flame retardant jacket allows ECO316 to meet fire resistance standards.
- **Advantageous in term of price:** ECO316 design has integrated all Radiall knowledge to reach the best performance with a very competitive price. ECO316 is UL style 1375 approved. **This cable is compatible with a large range of connector series.**

ECO-Friendly cable
Cost effective solution

CONSTRUCTION / DIMENSIONS

	Material	mm	Inches
Center conductor	Solid OFC ⁽¹⁾	0.55	0.022
Dielectric	Foam PE ⁽²⁾	1.55	0.061
Inner shield	OFC ⁽¹⁾ braid	1.90	0.075
Outer shield	-	-	-
Jacket	Black LSZH PE ⁽³⁾	2.45	0.096

ELECTRICAL CHARACTERISTICS

Characteristic impedance	50Ω ± 2Ω	
Operating frequency range	DC - 3 GHz	
Shielding effectiveness	50 dB	
Voltage withstanding	2 000 V rms	
Peak power	1.4 kW	
Capacitance	84 pF / m	25.5 pF / ft
Velocity of propagation	80 % (4.15 ns / m)	

MECHANICAL CHARACTERISTICS

Recommended minimum bending radius	15 mm	0.590 inch
Weight	10 g / m	0.0066 lbs / ft

ENVIRONMENTAL CHARACTERISTICS

Operating temperature range	-40 / +85 °C	-40 / +185 °F
Fire resistance	yes (UL1581 VW1 / IEC 332-1)	
Halogen free	yes (IEC 754-2)	

FREQUENCY / ATTENUATION (typ.) / CW MAX POWER (sea level / 25 °C)

GHz	dB / m	dB / ft	Watts
0.1	0.24	0.07	120
0.2	0.33	0.10	85
0.3	0.41	0.12	69
0.5	0.53	0.16	54
1.0	0.76	0.23	38
1.5	0.94	0.28	31
2.0	1.09	0.33	27
2.5	1.22	0.37	24
3.0	1.34	0.41	22
Attenuation calculation (dB/m)	[0.74 x √f GHz] + [0.02 x f GHz]		
Power calculation (W)	38 / √f GHz		

⁽¹⁾ OFC = Oxygen Free Copper
⁽²⁾ PE = PolyEthylene
⁽³⁾ LSZH PE = Low Smoke Zero Halogen PolyEthylene

Flexible cable 2.6/50 S (ECO316X)



ECO-Friendly cable
Cost effective solution

P/N: C291 171 083

APPLICATION NOTE

Designed by Radiall, ECO316X is an alternative solution to ECO316 when higher power level is required:

- **Advantageous in term of electrical performance:** the crosslink foam polyethylene used as dielectric material allows higher temperature level (thus power range) than ECO316.
 - **Environmental advantages:** halogen and sulphur free, this cable does not emit any toxic substance when submitted to fire. The flame retardant jacket allows ECO316X to meet fire resistance standards.
 - **Advantageous in term of price:** ECO316X design has integrated all Radiall knowledge to reach the best performance with a very competitive price.
- ECO316X is UL style 1375 and 3651 approved
This cable is compatible with a large range of standard connector series.

Flexible cable 2.6/50 D (ECO316D: alternative to RD316)



ECO-Friendly cable
Cost effective solution

P/N: C291 999 905

APPLICATION NOTE

Designed by Radiall, ECO316D is an alternative solution to RD316:

- **Advantageous in term of electrical performance:** its optimized construction allows better attenuation and screening effectiveness than RD316.
 - **Environmental advantages:** halogen and sulphur free, this cable does not emit any toxic substance when submitted to fire. The flame retardant jacket allows ECO316D to meet fire resistance standards.
 - **Advantageous in term of price:** ECO316D design has integrated all Radiall knowledge to reach the best performance with a very competitive price.
- ECO316D is UL style 1375 approved.
This cable is compatible with a large range of connector series.

CONSTRUCTION / DIMENSIONS

	Material	mm	Inches
Center conductor	Stranded SPC ⁽¹⁾	0.54	0.021
Dielectric	X foam PE ⁽²⁾	1.54	0.061
Inner shield	SPC ⁽¹⁾ braid	2.05	0.081
Jacket	Blue LSZH PE ⁽³⁾	2.52	0.099

ELECTRICAL CHARACTERISTICS

Characteristic impedance	50Ω ± 2Ω
Operating frequency range	DC - 3 GHz
Shielding effectiveness	35 dB
Voltage withstanding	3 000 V rms
Capacitance	94.5 pF / m 28.7 pF / ft
Velocity of propagation	71 % (4.7 ns / m)

MECHANICAL CHARACTERISTICS

Recommended minimum bending radius	5 mm	0.197 inch
Weight	16 g / m	0.011 lbs / ft

ENVIRONMENTAL CHARACTERISTICS

Operating temperature range	-40 / +105 °C	-40 / +221 °F
Fire resistance	yes (UL1581 VW1 / IEC 332-1)	
Halogen free	yes (IEC 754-2)	

FREQUENCY / ATTENUATION (typ.) /
CW MAX POWER (sea level / 20 °C)

GHz	dB / m	dB / ft	Watts
0.1	0.27	0.08	285
0.3	0.49	0.15	164
0.5	0.65	0.20	127
0.6	0.72	0.22	116
0.8	0.84	0.26	101
1.0	0.96	0.29	90
1.5	1.22	0.37	73
2.0	1.45	0.44	64
2.5	1.66	0.50	57
3.0	1.85	0.56	52
Attenuation calculation (dB/m)	[0.81 x √f GHz] + [0.15 x f GHz]		
Power calculation (W)	90 / √f GHz		

⁽¹⁾ SPC = Silver Plated Copper

⁽²⁾ X foam PE = Crosslink foam PolyEthylene

⁽³⁾ LSZH PE = Low Smoke Zero Halogen PolyEthylene

Note:

Typical attenuation for a couple of connectors (dB) = 0.045 x √f (GHz)

CONSTRUCTION / DIMENSIONS

	Material	mm	Inches
Center conductor	Solid OFC ⁽¹⁾	0.55	0.022
Dielectric	Foam PE ⁽²⁾	1.55	0.061
Inner shield	OFC ⁽¹⁾ braid	1.90	0.075
Outer shield	OFC ⁽¹⁾ braid	2.30	0.091
Jacket	Black LSZH PE ⁽³⁾	2.80	0.110

ELECTRICAL CHARACTERISTICS

Characteristic impedance	50Ω ± 2Ω
Operating frequency range	DC - 3 GHz
Shielding effectiveness	65 dB
Voltage withstanding	2 000 V rms
Peak power	1.4 kW
Capacitance	84 pF / m 25.5 pF / ft
Velocity of propagation	80 % (4.15 ns / m)

MECHANICAL CHARACTERISTICS

Recommended minimum bending radius	15 mm	0.590 inch
Weight	16 g / m	0.0106 lbs / ft

ENVIRONMENTAL CHARACTERISTICS

Operating temperature range	-40 / +85 °C	-40 / +185 °F
Fire resistance	yes (UL 1581 VW1 / IEC 332-1)	
Halogen free	yes (IEC 754-2)	

FREQUENCY / ATTENUATION (typ.) /
CW MAX POWER (sea level / 25 °C)

GHz	dB / m	dB / ft	Watts
0.1	0.24	0.07	120
0.2	0.33	0.10	85
0.3	0.41	0.12	69
0.5	0.53	0.16	54
1.0	0.76	0.23	38
1.5	0.94	0.28	31
2.0	1.09	0.33	27
2.5	1.22	0.37	24
3.0	1.34	0.41	22
Attenuation calculation (dB/m)	[0.74 x √f GHz] + [0.02 x f GHz]		
Power calculation (W)	38 / √f GHz		

⁽¹⁾ OFC = Oxygen Free Copper

⁽²⁾ PE = PolyEthylene

⁽³⁾ LSZH PE = Low Smoke Zero Halogen PolyEthylene

Flexible cable 2.6/50 D (ECO316DX)



ECO-Friendly cable
Cost effective solution

P/N: C291 217 020

APPLICATION NOTE

Designed by Radiall, ECO316DX is an alternative solution to ECO316D when higher power level is required:

- **Advantageous in term of electrical performance:** the crosslink foam polyethylene used as dielectric material allows higher temperature level (thus power range) than ECO316D.
- **Environmental advantages:** halogen and sulphur free, this cable does not emit any toxic substance when submitted to fire. The flame retardant jacket allows ECO316DX to meet fire resistance standards.
- **Advantageous in term of price:** ECO316DX design has integrated all Radiall knowledge to reach the best performance with a very competitive price. ECO316DX is UL style 1375 and 3651 approved. **This cable is compatible with a large range of standard connector series.**

CONSTRUCTION / DIMENSIONS

	Material	mm	Inches
Center conductor	Stranded SPC ⁽¹⁾	0.54	0.021
Dielectric	X foam PE ⁽²⁾	1.54	0.061
Inner shield	SPC ⁽¹⁾ braid	2.03	0.080
Outer shield	SPC ⁽¹⁾ braid	2.50	0.098
Jacket	Black with blue stripe LSZH PE ⁽³⁾	3.16	0.124

ELECTRICAL CHARACTERISTICS

Characteristic impedance	50Ω ± 2Ω	
Operating frequency range	DC - 6 GHz	
Shielding effectiveness	70 dB (DC - 5 GHz)	
Voltage withstanding	1 500 V rms	
Capacitance	94.5 pF / m	28.7 pF / ft
Velocity of propagation	71 % (4.7 ns / m)	

MECHANICAL CHARACTERISTICS

Recommended minimum bending radius	5 mm	0.196 inch
Weight	21 g / m	0.0140 lbs / ft

ENVIRONMENTAL CHARACTERISTICS

Operating temperature range	-40 / +105 °C	-40 / +221 °F
Fire resistance	yes (UL1581 VW1 / IEC 332-1)	
Halogen free	yes (IEC 754-2)	

FREQUENCY / ATTENUATION (typ.) /
CW MAX POWER (sea level / 25 °C)

GHz	dB / m	dB / ft	Watts
0.5	0.58	0.17	127
1.0	0.86	0.26	90
1.5	1.09	0.33	73
2.0	1.30	0.40	64
2.5	1.50	0.45	57
3.0	1.68	0.51	52
3.5	1.85	0.56	48
4.0	2.02	0.61	45
5.0	2.34	0.71	40
6.0	2.64	0.80	37
Attenuation calculation (dB/m)	[0.71 x √f GHz] + [0.15 x f GHz]		
Power calculation (W)	90 / √f GHz		

⁽¹⁾ SPC = Silver Plated Copper

⁽²⁾ X foam PE = Crosslink foam PolyEthylene

⁽³⁾ LSZH PE = Low Smoke Zero Halogen PolyEthylene

Note:

Typical attenuation for a couple of connectors (dB) = 0.045 x √f (GHz)

Flexible cable 5/50 D (ECO142: alternative to RG142)



ECO-Friendly cable
Cost effective solution

P/N: C291 325 290

APPLICATION NOTE

Designed by Radiall, ECO142 is an alternative solution to RG142:

- **Advantageous in term of electrical performance:** its optimized construction allows better attenuation and screening effectiveness than RG142.
- **Environmental advantages:** halogen and sulphur free, this cable does not emit any toxic substance when submitted to fire. The flame retardant jacket allows ECO142 to meet fire resistance standards.
- **Advantageous in term of price:** ECO142 design has integrated all Radiall knowledge to reach the best performance with a very competitive price. ECO142 is UL style 1375 approved. **This cable is compatible with a large range of connector series.**

CONSTRUCTION / DIMENSIONS

	Material	mm	Inches
Center conductor	Solid OFC ⁽¹⁾ copper	0.95	0.037
Dielectric	Foam PE ⁽²⁾	2.85	0.112
Inner shield	Al ⁽³⁾ foil	3.10	0.122
Outer shield	TC ⁽⁴⁾ braid	3.50	0.138
Jacket	Black LSZH PE ⁽⁵⁾	4.50	0.177

ELECTRICAL CHARACTERISTICS

Characteristic impedance	50Ω ± 2Ω	
Operating frequency range	DC - 3 GHz	
Shielding effectiveness	80 dB (DC - 3 GHz)	
Voltage withstanding	5 000 V rms	
Peak power	2.7 kW	
Capacitance	87 pF / m	26.4 pF / ft
Velocity of propagation	77 % (4.3 ns / m)	

MECHANICAL CHARACTERISTICS

Recommended minimum bending radius	15 mm	0.590 inch
Weight	36 g / m	0.0242 lbs / ft

ENVIRONMENTAL CHARACTERISTICS

Operating temperature range	-40 / +85 °C	-40 / +185 °F
Fire resistance	yes (UL1581 VW1 / IEC 332-1)	
Halogen free	yes (IEC 754-2)	

FREQUENCY / ATTENUATION (typ.) /
CW MAX POWER (sea level / 25 °C)

GHz	dB / m	dB / ft	Watts
0.1	0.12	0.04	411
0.2	0.18	0.05	291
0.3	0.22	0.07	237
0.5	0.28	0.09	184
1.0	0.41	0.12	130
1.5	0.50	0.15	106
2.0	0.58	0.18	92
2.5	0.66	0.20	82
3.0	0.73	0.22	75
Attenuation calculation (dB/m)	[0.385 x √f GHz] + [0.02 x f GHz]		
Power calculation (W)	130 / √f GHz		

⁽¹⁾ OFC = Oxygen Free Copper

⁽²⁾ PE = PolyEthylene

⁽³⁾ Al = Aluminum

⁽⁴⁾ TC = Tinned Copper

⁽⁵⁾ LSZH PE = Low Smoke Zero Halogen PolyEthylene

Flexible cable 5/50 D (ECO142X)



ECO-Friendly cable
Cost effective solution

P/N: C291 320 180

APPLICATION NOTE

Designed by Radiall, ECO142X is an alternative solution to ECO142 when higher power level is required:

- **Advantageous in term of electrical performance:** the crosslink foam polyethylene used as dielectric material allows higher temperature level (thus power range) than ECO142.
- **Environmental advantages:** halogen and sulphur free, this cable does not emit any toxic substance when submitted to fire. The flame retardant jacket allows ECO142X to meet fire resistance standards.
- **Advantageous in term of price:** ECO142X design has integrated all Radiall knowledge to reach the best performance with a very competitive price. ECO142X is UL style 1375 and 3651 approved. This cable is compatible with a large range of standard connector series.

CONSTRUCTION / DIMENSIONS

	Material	mm	inches
Center conductor	Solid SPC ⁽¹⁾	0.95	0.037
Dielectric	X foam PE ⁽²⁾	2.98	0.117
Inner shield	SPC ⁽¹⁾ braid	3.64	0.143
Outer shield	SPC ⁽¹⁾ braid	4.30	0.169
Jacket	Black with blue stripe LSZH PE ⁽³⁾	5.00	0.197

ELECTRICAL CHARACTERISTICS

Characteristic impedance	50Ω ± 2Ω	
Operating frequency range	DC - 6 GHz	
Shielding effectiveness	75 dB (DC - 5 GHz)	
Voltage withstanding	5 000 V rms	
Capacitance	94.5 pF / m	28.7 pF / ft
Velocity of propagation	71 % (4.7 ns / m)	

MECHANICAL CHARACTERISTICS

Recommended minimum bending radius	30 mm	1.18 inch
Weight	60 g / m	0.0433 lbs / ft

ENVIRONMENTAL CHARACTERISTICS

Operating temperature range	-40 / +105 °C	-40 / +221 °F
Fire resistance	yes (UL1581 VW1 / IEC 332-1)	
Halogen free	yes (IEC 754-2)	

FREQUENCY / ATTENUATION (typ.) / CW MAX POWER (sea level / 25 °C)

GHz	dB / m	dB / ft	Watts
0.5	0.36	0.11	354
1.0	0.54	0.16	250
1.5	0.69	0.21	204
2.0	0.83	0.25	177
2.5	0.95	0.29	158
3.0	1.07	0.32	144
3.5	1.18	0.36	134
4.0	1.29	0.39	125
5.0	1.50	0.45	112
6.0	1.70	0.51	102
Attenuation calculation (dB/m)	[0.44 x √f GHz] + [0.103 x f GHz]		
Power calculation (W)	250 / √f GHz		

⁽¹⁾ SPC = Silver Plated Copper

⁽²⁾ X foam PE = Crosslink foam PolyEthylene

⁽³⁾ LSZH PE = Low Smoke Zero Halogen PolyEthylene

Note:

Typical attenuation for a couple of connectors (dB) = 0.045 x √f (GHz)

Flexible cable 5/50 D (Power 142: alternative to RG142)



P/N: C291 325 270

APPLICATION NOTE

Designed by Radiall, POWER142 is an alternative solution to ECO142 when high power level is required:

- **Advantageous in term of electrical performance:** its optimized construction allows better attenuation and screening effectiveness than RG142 and higher power level than ECO142.
- **Environmental advantages:** the flame retardant jacket allows POWER142 to meet fire resistance standards.
- **Advantageous in term of price:** POWER142 design has integrated all Radiall knowledge to reach the best performance with a very competitive price. POWER142 is UL style 1375 approved. This cable is compatible with a large range of connector series.

CONSTRUCTION / DIMENSIONS

	Material	mm	Inches
Center conductor	Solid SPC ⁽¹⁾	0.92	0.036
Dielectric	Solid PTFE ⁽²⁾	2.97	0.117
Inner shield	Al ⁽³⁾ foil	3.20	0.126
Outer shield	TC ⁽⁴⁾ braid	3.60	0.142
Jacket	Black LSZH PE ⁽⁵⁾	4.50	0.177

ELECTRICAL CHARACTERISTICS

Characteristic impedance	50Ω ± 2Ω	
Operating frequency range	DC - 3 GHz	
Shielding effectiveness	90 dB (DC - 3 GHz)	
Voltage withstanding	5 000 V rms	
Peak power	3.4 kW	
Capacitance	97 pF / m	29.3 pF / ft
Velocity of propagation	69 % (4.8 ns / m)	

MECHANICAL CHARACTERISTICS

Recommended minimum bending radius	25 mm	0.980 inch
Weight	40 g / m	0.0269 lbs / ft

ENVIRONMENTAL CHARACTERISTICS

Operating temperature range	-40 / +105 °C	-40 / +221 °F
Fire resistance	yes (UL1581 VW1 / IEC 332-1)	
Halogen free	no	

FREQUENCY / ATTENUATION (typ.) / CW MAX POWER (sea level / 40 °C)

GHz	dB / m	dB / ft	Watts
0.2	0.18	0.05	470
0.4	0.26	0.08	332
0.6	0.32	0.10	271
0.8	0.37	0.11	235
1.0	0.41	0.12	210
1.5	0.50	0.15	171
2.0	0.58	0.18	148
2.5	0.66	0.20	133
3.0	0.72	0.22	121
Attenuation calculation (dB/m)	[0.402 x √f GHz] + [0.008 x f GHz]		
Power calculation (W)	210 / √f GHz		

⁽¹⁾ SPC = Silver Plated Copper

⁽²⁾ PTFE = PolyTetraFluoroEthylene

⁽³⁾ Al = Aluminum

⁽⁴⁾ TC = Tinned Copper

⁽⁵⁾ LSZH PE = Low Smoke Zero Halogen PolyEthylene

Flexible cable 6/50 D (ECO230)



P/N: C291 326 490

APPLICATION NOTE

Designed by Radiall, ECO230 is an alternative solution to 5 mm dia. cables when higher power level is required:

- **Advantageous in term of electrical performance:** its optimized construction allows better attenuation and screening effectiveness than RG cables.
- **Environmental advantages:** halogen and sulphur free, this cable does not emit any toxic substance when submitted to fire. The flame retardant jacket allows ECO230 to meet fire resistance standards.
- **Advantageous in term of price:** ECO230 design has integrated all Radiall knowledge to reach the best performance with a very competitive price. ECO230 is UL style 1375 approved.

CONSTRUCTION / DIMENSIONS

	Material	mm	Inches
Center conductor	OFC ⁽¹⁾ copper	1.46	0.057
Dielectric	Foam PE ⁽²⁾	4.07	0.160
Inner shield	Al ⁽³⁾ foil	4.27	0.168
Outer shield	TC ⁽⁴⁾ braid	4.75	0.187
Jacket	Black LSZH ⁽⁵⁾ PE	5.90	0.232

ELECTRICAL CHARACTERISTICS

Characteristic impedance	50Ω ± 2Ω	
Operating frequency range	DC - 4 GHz	
Shielding effectiveness	90 dB (DC - 3 GHz)	
Voltage withstanding	3 000 V rms	
Peak power	3.3 kW	
Capacitance	84 pF / m	25.5 pF / ft
Velocity of propagation	79 % [4.2 ns / m]	

MECHANICAL CHARACTERISTICS

Recommended minimum bending radius	25 mm	0.98 inch
Weight	62 g / m	0.0417 lbs / ft

ENVIRONMENTAL CHARACTERISTICS

Operating temperature range	-40 / +85 °C	-40 / +185 °F
Fire resistance	yes (UL1581 VW1 / IEC 332-1)	
Halogen free	yes (IEC 754-2)	

FREQUENCY / ATTENUATION (typ.) / CW MAX POWER (sea level / 40 °C)

GHz	dB / m	dB / ft	Watts
0.2	0.12	0.04	391
0.4	0.17	0.05	277
0.6	0.21	0.06	226
0.8	0.25	0.08	196
1.0	0.28	0.08	175
1.5	0.35	0.10	143
2.0	0.40	0.12	124
2.5	0.45	0.14	111
3.0	0.50	0.15	101
4.0	0.59	0.18	88
Attenuation calculation (dB/m)	[0.264 x √f GHz] + [0.015 x f GHz]		
Power calculation (W)	175 / √f GHz		

⁽¹⁾ OFC = Oxygen Free Copper

⁽²⁾ PE = PolyEthylene

⁽³⁾ Al = Aluminum

⁽⁴⁾ TC = Tinned Copper

⁽⁵⁾ LSZH PE = Low Smoke Zero Halogen PolyEthylene

Note:

Typical attenuation for a couple of connectors (dB) = 0.045 x √f (GHz)

Flexible cable 10/50 D (ECO393: alternative to RG393)



P/N: C291 491 060

APPLICATION NOTE

Designed by Radiall, ECO393 is an alternative solution to RG393:

- **Advantageous in term of electrical performance:** its optimized construction allows better attenuation and screening effectiveness than RG393
- **Environmental advantages:** halogen and sulphur free, this cable does not emit any toxic substance when submitted to fire. The flame retardant jacket allows ECO393 to meet fire resistance standards.
- **Advantageous in term of price:** ECO393 design has integrated all Radiall knowledge to reach the best performance with a very competitive price. ECO393 is UL style 1375 approved. This cable is compatible with a large range of connector series.

ECO-Friendly cable
Cost effective solution

CONSTRUCTION / DIMENSIONS

	Material	mm	Inches
Center conductor	Solid OFC ⁽¹⁾	2.40	0.094
Dielectric	Foam PE ⁽²⁾	7.25	0.285
Inner shield	Al ⁽³⁾ foil	7.35	0.289
Outer shield	TC ⁽⁴⁾ braid	7.85	0.309
Jacket	Black LSZH PE ⁽⁵⁾	9.10	0.358

ELECTRICAL CHARACTERISTICS

Characteristic impedance	50Ω ± 2Ω	
Operating frequency range	DC - 3 GHz	
Shielding effectiveness	80 dB (DC - 3 GHz)	
Voltage withstanding	10 000 V rms	
Peak power	6.6 kW	
Capacitance	88 pF / m	26.6 pF / ft
Velocity of propagation	75 % [4.4 ns / m]	

MECHANICAL CHARACTERISTICS

Recommended minimum bending radius	40 mm	1.57 inch
Weight	130 g / m	0.0875 lbs / ft

ENVIRONMENTAL CHARACTERISTICS

Operating temperature range	-40 / +85 °C	-40 / +185 °F
Fire resistance	yes (UL1581 VW1 / IEC 332-1)	
Halogen free	yes (IEC 754-2)	

FREQUENCY / ATTENUATION (typ.) / CW MAX POWER (sea level / 25 °C)

GHz	dB / m	dB / ft	Watts
0.1	0.05	0.01	1 265
0.2	0.07	0.02	894
0.3	0.08	0.03	730
0.5	0.11	0.03	566
1.0	0.16	0.05	400
1.5	0.20	0.06	327
2.0	0.24	0.07	283
2.5	0.27	0.08	253
3.0	0.30	0.09	231
Attenuation calculation (dB/m)	[0.14 x √f GHz] + [0.02 x f GHz]		
Power calculation (W)	400 / √f GHz		

⁽¹⁾ OFC = Oxygen Free Copper

⁽²⁾ PE = PolyEthylene

⁽³⁾ Al = Aluminum

⁽⁴⁾ TC = Tinned Copper

⁽⁵⁾ LSZH PE = Low Smoke Zero Halogen PolyEthylene

Flexible cable 10/50 D (ECO393X)



ECO-Friendly cable
Cost effective solution

P/N: C291 512 020

APPLICATION NOTE

Designed by Radiall, ECO393X is an alternative solution to ECO393 when higher power level is required:

- **Advantageous in term of electrical performance:** the crosslink foam polyethylene used as dielectric material allows higher temperature level (thus power range) than ECO393.
- **Environmental advantages:** halogen and sulphur free, this cable does not emit any toxic substance when submitted to fire. The flame retardant jacket allows ECO393X to meet fire resistance standards.
- **Advantageous in term of price:** ECO393X design has integrated all Radiall knowledge to reach the best performance with a very competitive price. ECO393X is UL style 3651 approved. **This cable is compatible with a large range of standard connector series.**

CONSTRUCTION / DIMENSIONS

	Material	mm	Inches
Center conductor	Stranded SPC ⁽¹⁾	2.35	0.093
Dielectric	X foam PE ⁽²⁾	7.20	0.283
Inner shield	SPC ⁽¹⁾ braid	7.89	0.311
Outer shield	SPC ⁽¹⁾ braid	8.57	0.337
Jacket	Black LSZH PE ⁽³⁾	10.00	0.394

ELECTRICAL CHARACTERISTICS

Characteristic impedance	50Ω ± 2Ω	
Operating frequency range	DC - 6 GHz	
Shielding effectiveness	78 dB [DC - 3 GHz]	
Voltage withstanding	5 000 V rms	
Capacitance	94 pF / m	28.1 pF / ft
Velocity of propagation	71 % (4.7 ns / m)	

MECHANICAL CHARACTERISTICS

Recommended minimum bending radius	50 mm	1.97 inch
Weight	180 g / m	0.120 lbs / ft

ENVIRONMENTAL CHARACTERISTICS

Operating temperature range	-40 / +105 °C	-40 / +221 °F
Fire resistance	yes [UL1581 VW1]	
Halogen free	yes [IEC 754-2]	

FREQUENCY / ATTENUATION (typ.) / CW MAX POWER (sea level / 25 °C)

GHz	dB / m	dB / ft	Watts
0.5	0.18	0.05	693
1.0	0.29	0.09	490
1.5	0.38	0.12	400
2.0	0.47	0.14	346
2.5	0.56	0.17	310
3.0	0.64	0.19	283
3.5	0.72	0.22	262
4.0	0.80	0.24	245
5.0	0.96	0.29	219
6.0	1.11	0.34	200
Attenuation calculation (dB/m)	[0.17 x √f GHz] + [0.115 x f GHz]		
Power calculation (W)	490 / √f GHz		

⁽¹⁾ SPC = Silver Plated Copper

⁽²⁾ X foam PE = Crosslink foam PolyEthylene

⁽³⁾ LSZH PE = Low Smoke Zero Halogen PolyEthylene

Note:

Typical attenuation for a couple of connectors (dB) = 0.045 x √f (GHz)

Corrugated cable 1/4" (Cellflex 1/4" Spiral)



P/N: C291 993 170

(Cellflex HCF 1/4" - 50 AlCu)

APPLICATION NOTE

The outer conductor of this cable is made up of a corrugated tube (spiral winding). This construction allows perfect shielding and bendability while enabling a large bending radius. The foam dielectric provides excellent loss and low return loss levels. This cable will be advised for feeder and jumper assemblies in cellular networks as well as applications requiring high performance level on long distances. The anti-UV LSZH (Low Smoke Zero Halogen) material is also flame retardant and allows this cable to be used for indoor public areas as well as outdoor installations.

CONSTRUCTION / DIMENSIONS

	Material	mm	Inches
Center conductor	Solid AlCC ⁽¹⁾	1.90	0.075
Dielectric	Foam PE ⁽²⁾	4.30	0.169
Corrugated inner shield	Spiral copper tube	6.50	0.256
Outer shield	-	-	-
Jacket	Black LSZH PE ⁽³⁾	7.80	0.307

ELECTRICAL CHARACTERISTICS

Characteristic impedance	50Ω ± 1Ω	
Operating frequency range	DC - 20.4 GHz	
Shielding effectiveness	110 dB	
Voltage withstanding	3 100 V rms	
Peak power	5.5 kW	
Capacitance	82 pF / m	24.8 pF / ft
Velocity of propagation	82 % (4.1 ns / m)	

MECHANICAL CHARACTERISTICS

Recommended minimum bending radius	25.0 mm	0.984 inch
Weight	70 g / m	0.047 lb / ft

ENVIRONMENTAL CHARACTERISTICS

Operating temperature range	-40 / +85 °C	-40 / +185 °F
Fire resistance	yes [UL 1581 VW1 / IEC 332-1]	
Halogen free	yes [IEC 754-2]	

FREQUENCY / ATTENUATION (typ. / 25 °C) / CW MAX POWER (sea level / 40 °C)

GHz	dB / m	dB / ft	Watts
1.0	0.19	0.06	339
2.0	0.27	0.08	232
3.0	0.34	0.10	185
4.0	0.40	0.12	156
6.0	0.51	0.15	124
8.0	0.60	0.18	104
10.0	0.69	0.21	91
12.4	0.78	0.24	79
18.0	0.99	0.30	63
20.0	1.06	0.32	59
Attenuation calculation (dB/m)	[0.17 x √f GHz] + [0.015 x f GHz]		

⁽¹⁾ AlCC = Aluminum Covered Copper

⁽²⁾ PE = PolyEthylene

⁽³⁾ LSZH PE = Low Smoke Zero Halogen PolyEthylene

Corrugated cable 3/8" (Cellflex 3/8" Spiral)



P/N: C291 996 170 (Cellflex HCF 3/8" CuH-50 AlCu)

APPLICATION NOTE

The outer conductor of this cable is made up of a corrugated tube (spiral winding). This construction allows perfect shielding and bendability while enabling large bending radius. The foam dielectric provides excellent loss and low return loss levels. This cable is suitable for feeder and jumper assemblies in cellular networks as well as applications requiring high performance level on long distances. The anti-UV LSZH (Low Smoke Zero Halogen) material is also flame retardant and allows this cable to be used for indoor public areas as well as outdoor installations.

CONSTRUCTION / DIMENSIONS

	Material	mm	Inches
Center conductor	Solid AlCC ⁽¹⁾	2.60	0.102
Dielectric	Foam PE ⁽²⁾	6.30	0.248
Corrugated inner shield	Spiral copper tube	9.10	0.358
Outer shield	-	-	-
Jacket	Black LSZH PE ⁽³⁾	10.20	0.402

ELECTRICAL CHARACTERISTICS

Characteristic impedance	50Ω ± 1Ω	
Operating frequency range	DC - 13.4 GHz	
Shielding effectiveness	110 dB	
Voltage withstanding	4 500 V rms	
Peak power	11.9 kW	
Capacitance	82 pF / m	24.8 pF / ft
Velocity of propagation	82 % (4.1 ns / m)	

MECHANICAL CHARACTERISTICS

Recommended minimum bending radius	25.0 mm	0.984 inch
Weight	120 g / m	0.080 lbs / ft

ENVIRONMENTAL CHARACTERISTICS

Operating temperature range	-40 / +85 °C	-40 / +185 °F
Fire resistance	yes (UL 1581 VW1 / IEC 332-1)	
Halogen free	yes (IEC 754-2)	

FREQUENCY / ATTENUATION (typ. / 25 °C) / CW MAX POWER (sea level / 40 °C)

GHz	dB / m	dB / ft	Watts
0.5	0.09	0.03	810
1.0	0.13	0.04	560
1.5	0.17	0.05	449
2.0	0.19	0.06	384
3.0	0.24	0.07	306
4.0	0.29	0.09	260
6.0	0.36	0.11	205
8.0	0.43	0.13	173
10.0	0.49	0.15	152
12.4	0.56	0.17	133
Attenuation calculation (dB/m)	[0.123 x √f GHz] + [0.01 x f GHz]		

⁽¹⁾ AlCC = Aluminum Covered Copper
⁽²⁾ PE = PolyEthylene
⁽³⁾ LSZH PE = Low Smoke Zero Halogen PolyEthylene

Note:
 Typical attenuation for a couple of connectors (dB) = 0.045 x √f (GHz)

Corrugated cable 1/2" (Cellflex 1/2" Spiral)



P/N: C291 994 170 (Cellflex HCF 1/2" CuH-50 AlCu)

APPLICATION NOTE

The outer conductor of this cable is made up of a corrugated tube (spiral winding). This construction allows perfect shielding and bendability while enabling large bending radius. The foam dielectric provides excellent loss and low return loss levels. This cable will be advised for feeder and jumper assemblies in cellular networks as well as applications requiring high performance level on long distances. The anti-UV LSZH (Low Smoke Zero Halogen) material is also flame retardant and allows this cable to be used for indoor public areas as well as outdoor installations.

CONSTRUCTION / DIMENSIONS

	Material	mm	Inches
Center conductor	Solid AlCC ⁽¹⁾	3.60	0.142
Dielectric	Foam PE ⁽²⁾	8.30	0.327
Corrugated inner shield	Spiral copper tube	12.30	0.484
Outer shield	-	-	-
Jacket	Black LSZH PE ⁽³⁾	13.50	0.531

ELECTRICAL CHARACTERISTICS

Characteristic impedance	50Ω ± 1Ω	
Operating frequency range	DC - 11.7 GHz	
Shielding effectiveness	110 dB	
Voltage withstanding	5 845 V rms	
Peak power	20.5 kW	
Capacitance	82 pF / m	24.8 pF / ft
Velocity of propagation	82 % (4.1 ns / m)	

MECHANICAL CHARACTERISTICS

Recommended minimum bending radius	32.0 mm	1.260 inch
Weight	210 g / m	0.140 lbs / ft

ENVIRONMENTAL CHARACTERISTICS

Operating temperature range	-40 / +85 °C	-40 / +185 °F
Fire resistance	yes (UL 1581 VW1 / IEC 332-1)	
Halogen free	yes (IEC 754-2)	

FREQUENCY / ATTENUATION (typ. / 25 °C) / CW MAX POWER (sea level / 40 °C)

GHz	dB / m	dB / ft	Watts
0.5	0.08	0.02	1 120
1.0	0.11	0.03	770
1.5	0.14	0.04	616
2.0	0.16	0.05	525
2.5	0.18	0.06	461
3.0	0.20	0.06	417
4.0	0.24	0.07	353
6.0	0.30	0.09	278
8.0	0.36	0.11	234
10.0	0.42	0.13	204
Attenuation calculation (dB/m)	[0.10 x √f GHz] + [0.01 x f GHz]		

⁽¹⁾ AlCC = Aluminum Covered Copper
⁽²⁾ PE = PolyEthylene
⁽³⁾ LSZH PE = Low Smoke Zero Halogen PolyEthylene

Semi-rigid cable .047 (Copper)



**P/N: C291 855 001
(MIL-C-17/151-00001)**

APPLICATION NOTE

This is the smallest semi-rigid cable size available through Radiall.
Its reduced size allows it to be easily handformable during integration operations.

CONSTRUCTION / DIMENSIONS

	Material	mm	Inches
Center conductor	Solid SPCCS ⁽¹⁾	0.29	0.011
Dielectric	Solid PTFE ⁽²⁾	0.94	0.037
Inner shield	Copper tubing	1.19	0.047
Outer shield	-	-	-
Jacket	-	-	-

ELECTRICAL CHARACTERISTICS

Characteristic impedance	50Ω ± 2.5Ω	
Operating frequency range	DC - 20 GHz	
Shielding effectiveness	110 dB	
Voltage withstanding	2 000 V rms	
Peak power	1.1 kW	
Capacitance	100 pF / m	30 pF / ft
Velocity of propagation	70 % (4.8 ns / m)	

MECHANICAL CHARACTERISTICS

Recommended minimum bending radius	3.17 mm	0.125 inch
Weight	6.0 g / m	0.0040 lbs / ft

ENVIRONMENTAL CHARACTERISTICS

Operating temperature range	-40 / +100 °C	-40 / +212 °F
Fire resistance	not applicable	
Halogen free	no	

FREQUENCY / ATTENUATION (typ.) / CW MAX POWER (sea level / 25 °C)

GHz	dB / m	dB / ft	Watts
1.0	1.14	0.35	30
2.0	1.64	0.50	21
3.0	2.03	0.61	17
6.0	2.93	0.89	12
8.0	3.43	1.04	11
10.0	3.88	1.18	9.5
12.4	4.37	1.32	8.5
18.0	5.39	1.63	7.1
20.0	5.72	1.73	6.7
Attenuation calculation (dB/m)	[1.10 x √f GHz] + [0.04 x f GHz]		
Power calculation (W)	30 / √f GHz		

⁽¹⁾ SPCCS = Silver Plated Copper Covered Steel

⁽²⁾ PTFE = PolyTetraFluoroEthylene

Semi-rigid cable .047 (Tinned copper)



P/N: C291 855 065 (MIL-C-17/151-00002 TYPE)

APPLICATION NOTE

This is the smallest semi-rigid cable size available at Radiall.
Its reduced size allows it to be easily handformable during integration operations.
Due to the outer conductor coating (tin), this cable will be used instead of standard .047 copper for applications requiring high corrosion resistance and improved solderability.

CONSTRUCTION / DIMENSIONS

	Material	mm	Inches
Center conductor	Solid SPCCS ⁽¹⁾	0.29	0.011
Dielectric	Solid PTFE ⁽²⁾	0.94	0.037
Inner shield	TC ⁽³⁾ tubing	1.19	0.047
Outer shield	-	-	-
Jacket	-	-	-

ELECTRICAL CHARACTERISTICS

Characteristic impedance	50Ω ± 2.5Ω	
Operating frequency range	DC - 20 GHz	
Shielding effectiveness	110 dB	
Voltage withstanding	2 000 V rms	
Peak power	1.1 kW	
Capacitance	100 pF / m	30 pF / ft
Velocity of propagation	70 % (4.8 ns / m)	

MECHANICAL CHARACTERISTICS

Recommended minimum bending radius	3.17 mm	0.125 inch
Weight	6.0 g / m	0.0040 lbs / ft

ENVIRONMENTAL CHARACTERISTICS

Operating temperature range	-40 / +100 °C	-40 / +212 °F
Fire resistance	not applicable	
Halogen free	no	

FREQUENCY / ATTENUATION (typ.) / CW MAX POWER (sea level / 25 °C)

GHz	dB / m	dB / ft	Watts
1.0	1.14	0.35	30
2.0	1.64	0.50	21
3.0	2.03	0.61	17
6.0	2.93	0.89	12
8.0	3.43	1.04	11
10.0	3.88	1.18	9.5
12.4	4.37	1.32	8.5
18.0	5.39	1.63	7.1
20.0	5.72	1.73	6.7
Attenuation calculation (dB/m)	[1.10 x √f GHz] + [0.04 x f GHz]		
Power calculation (W)	30 / √f GHz		

⁽¹⁾ SPCCS = Silver Plated Copper Covered Steel

⁽²⁾ PTFE = PolyTetraFluoroEthylene

⁽³⁾ TC = Tinned Copper

Note:

Typical attenuation for a couple of connectors (dB) = 0.045 x √f (GHz)

Hand-formable cable .085 (unjacketed)



P/N: C291 844 065

APPLICATION NOTE

This handformable cable is the perfect alternative to RG405 for applications requiring an easy routing on equipment. Due to the outer conductor construction, this cable can be hand formed with exceptional ease with no spring back effect. Cable can be reshaped, eliminating the need for costly drawings. Attenuation is a little bit higher than RG405 but temperature range is wider.

CONSTRUCTION / DIMENSIONS

	Material	mm	Inches
Center conductor	Solid SPCCS ⁽¹⁾	0.51	0.020
Dielectric	Solid PTFE ⁽²⁾	1.63	0.064
Inner shield	copper foil	-	-
Outer shield	TS ⁽³⁾ braid	2.21	0.087
Jacket	-	-	-

ELECTRICAL CHARACTERISTICS

Characteristic impedance	50Ω ± 2Ω	
Operating frequency range	DC - 20 GHz	
Shielding effectiveness	90 dB	
Voltage withstanding	5 000 V rms	
Peak power	1.9 kW	
Capacitance	97.5 pF / m	29.5 pF / ft
Velocity of propagation	70 % (4.8 ns / m)	

MECHANICAL CHARACTERISTICS

Recommended minimum bending radius	3.2 ⁽⁴⁾ / 9.5 ⁽⁵⁾ mm	0.125 ⁽⁴⁾ / 0.375 ⁽⁵⁾ inch
Weight	17.8 g / m	0.0119 lbs / ft

ENVIRONMENTAL CHARACTERISTICS

Operating temperature range	-65 / +150 °C	-85 / +302 °F
Fire resistance	not applicable	
Halogen free	no	

FREQUENCY / ATTENUATION (typ.) / CW MAX POWER (sea level / 25 °C)

GHz	dB / m	dB / ft	Watts
1.0	0.67	0.20	100
2.0	0.97	0.29	71
3.0	1.21	0.37	58
6.0	1.78	0.54	41
8.0	2.10	0.64	35
10.0	2.39	0.72	32
12.4	2.71	0.82	28
18.0	3.39	1.03	24
20.0	3.62	1.10	22
Attenuation calculation (dB/m)	[0.63 x √f GHz] + [0.04 x f GHz]		
Power calculation (W)	100 / √f GHz		

⁽¹⁾ SPCCS = Silver Plated Copper Covered Steel

⁽²⁾ PTFE = PolyTetraFluoroEthylene

⁽³⁾ TS = Tin Soaked

⁽⁴⁾ one time

⁽⁵⁾ repeated

Note:

Typical attenuation for a couple of connectors (dB) = 0.045 x √f (GHz)

Semi-rigid cable .085 (RG405 - KS1)



**P/N: C291 850 001
(MIL-C-17/133-RG405)
(NF-C-93/551-KS1)**

APPLICATION NOTE

RG405 is one of the most popular semi-rigid RG cables. RG405 is a more preferred option to flexible RG316 or RD316 for applications requiring high frequency range, low attenuation, high screening effectiveness, very small bending radius and/or no spring back effect.

CONSTRUCTION / DIMENSIONS

	Material	mm	Inches
Center conductor	Solid SPCCS ⁽¹⁾	0.51	0.020
Dielectric	Solid PTFE ⁽²⁾	1.68	0.066
Inner shield	Copper tubing	2.20	0.087
Outer shield	-	-	-
Jacket	-	-	-

ELECTRICAL CHARACTERISTICS

Characteristic impedance	50Ω ± 1.5Ω	
Operating frequency range	DC - 20 GHz	
Shielding effectiveness	110 dB	
Voltage withstanding	5 000 V rms	
Peak power	1.9 kW	
Capacitance	100 pF / m	30 pF / ft
Velocity of propagation	70 % (4.8 ns / m)	

MECHANICAL CHARACTERISTICS

Recommended minimum bending radius	3.17 mm	0.125 inch
Weight	20.0 g / m	0.0135 lbs / ft

ENVIRONMENTAL CHARACTERISTICS

Operating temperature range	-40 / +125 °C	-40 / +257 °F
Fire resistance	not applicable	
Halogen free	no	

FREQUENCY / ATTENUATION (typ.) / CW MAX POWER (sea level / 25 °C)

GHz	dB / m	dB / ft	Watts
1.0	0.65	0.20	100
2.0	0.94	0.29	71
3.0	1.18	0.36	58
6.0	1.73	0.53	41
8.0	2.05	0.62	35
10.0	2.33	0.71	32
12.4	2.64	0.80	28
18.0	3.31	1.00	24
20.0	3.53	1.07	22
Attenuation calculation (dB/m)	[0.61 x √f GHz] + [0.04 x f GHz]		
Power calculation (W)	100 / √f GHz		

⁽¹⁾ SPCCS = Silver Plated Copper Covered Steel

⁽²⁾ PTFE = PolyTetraFluoroEthylene

Semi-rigid cable .085 (Tinned copper)



**P/N: C291 850 005
(MIL-C-17/133-00007)**

APPLICATION NOTE

Due to the outer conductor coating (tin), this cable can be used instead of RG405 for applications requiring high corrosion resistance and improved solderability.

CONSTRUCTION / DIMENSIONS

	Material	mm	Inches
Center conductor	Solid SPCCS ⁽¹⁾	0.51	0.020
Dielectric	Solid PTFE ⁽²⁾	1.68	0.066
Inner shield	TPC ⁽³⁾	2.20	0.087
Outer shield	-	-	-
Jacket	-	-	-

ELECTRICAL CHARACTERISTICS

Characteristic impedance	50Ω ± 1.5Ω	
Operating frequency range	DC - 20 GHz	
Shielding effectiveness	110 dB	
Voltage withstanding	5 000 V DC	
Peak power	1.9 kW	
Capacitance	100 pF / m	30 pF / ft
Velocity of propagation	70 % (4.8 ns / m)	

MECHANICAL CHARACTERISTICS

Recommended minimum bending radius	3.17 mm	0.125 inch
Weight	20.0 g / m	0.0135 lbs / ft

ENVIRONMENTAL CHARACTERISTICS

Operating temperature range	-40 / +125 °C	-40 / +257 °F
Fire resistance	not applicable	
Halogen free	no	

**FREQUENCY / ATTENUATION (typ.) /
CW MAX POWER (sea level / 25 °C)**

GHz	dB / m	dB / ft	Watts
1.0	0.65	0.20	100
2.0	0.94	0.29	71
3.0	1.18	0.36	58
6.0	1.73	0.53	41
8.0	2.05	0.62	35
10.0	2.33	0.71	32
12.4	2.64	0.80	28
18.0	3.31	1.00	24
20.0	3.53	1.07	22
Attenuation calculation (dB/m)	[0.61 x √f GHz] + [0.04 x f GHz]		
Power calculation (W)	100 / √f GHz		

⁽¹⁾ SPCCS = Silver Plated Copper Covered Steel

⁽²⁾ PTFE = PolyTetraFluoroEthylene

⁽³⁾ TPC = Tin Plated Copper

Semi-rigid cable .085 (Non magnetic)



**P/N: C291 851 001
(MIL-C-17/133-00008)**

APPLICATION NOTE

Based on RG405 standard, this cable is used where non magnetic is required.

CONSTRUCTION / DIMENSIONS

	Material	mm	Inches
Center conductor	Solid SPC ⁽¹⁾	0.51	0.020
Dielectric	Solid PTFE ⁽²⁾	1.68	0.066
Inner shield	Copper tubing	2.20	0.087
Outer shield	-	-	-
Jacket	-	-	-

ELECTRICAL CHARACTERISTICS

Characteristic impedance	50Ω ± 1.5Ω	
Operating frequency range	DC - 20 GHz	
Shielding effectiveness	110 dB	
Voltage withstanding	5 000 V rms	
Peak power	1.9 kW	
Capacitance	100 pF / m	30 pF / ft
Velocity of propagation	70 % (4.8 ns / m)	

MECHANICAL CHARACTERISTICS

Recommended minimum bending radius	3.17 mm	0.125 inch
Weight	20.0 g / m	0.0135 lbs / ft

ENVIRONMENTAL CHARACTERISTICS

Operating temperature range	-40 / +125 °C	-40 / +257 °F
Fire resistance	not applicable	
Halogen free	no	

**FREQUENCY / ATTENUATION (typ.) /
CW MAX POWER (sea level / 25 °C)**

GHz	dB / m	dB / ft	Watts
1.0	0.65	0.20	100
2.0	0.94	0.29	71
3.0	1.18	0.36	58
6.0	1.73	0.53	41
8.0	2.05	0.62	35
10.0	2.33	0.71	32
12.4	2.64	0.80	28
18.0	3.31	1.00	24
20.0	3.53	1.07	22
Attenuation calculation (dB/m)	[0.61 x √f GHz] + [0.04 x f GHz]		
Power calculation (W)	100 / √f GHz		

⁽¹⁾ SPC = Silver Plated Copper

⁽²⁾ PTFE = PolyTetraFluoroEthylene

Note:

Typical attenuation for a couple of connectors (dB) = 0.045 x √f (GHz)

Semi-rigid cable .085 (Aluminum)



P/N: C291 844 187
(MIL-C-17/133-00013)

APPLICATION NOTE

Based on RG405 standard, this cable will be selected for application requiring easy conformability and/or application requiring reduced weight.
 Due to the aluminum outer conductor, this cable can be hand formed with exceptional ease with no spring back effect.
 The cable can be reshaped, eliminating the need for costly drawings.
 The outer conductor material (aluminum) slightly increases the attenuation compared to standard RG405.

CONSTRUCTION / DIMENSIONS

	Material	mm	Inches
Center conductor	Solid SPCCS ⁽¹⁾	0.51	0.020
Dielectric	Solid PTFE ⁽²⁾	1.68	0.066
Inner shield	TPAI ⁽³⁾ tubing	2.20	0.087
Outer shield	-	-	-
Jacket	-	-	-

ELECTRICAL CHARACTERISTICS

Characteristic impedance	50Ω ± 1Ω	
Operating frequency range	DC - 20 GHz	
Shielding effectiveness	110 dB	
Voltage withstanding	5 000 V rms	
Peak power	1.9 kW	
Capacitance	100 pF / m	30 pF / ft
Velocity of propagation	70 % (4.8 ns / m)	

MECHANICAL CHARACTERISTICS

Recommended minimum bending radius	1.8 mm	0.07 inch
Weight	10.7 g / m	0.0072 lbs / ft

ENVIRONMENTAL CHARACTERISTICS

Operating temperature range	-40 / +125 °C	-40 / +257 °F
Fire resistance	not applicable	
Halogen free	no	

FREQUENCY / ATTENUATION (typ.) / CW MAX POWER (sea level / 25 °C)

GHz	dB / m	dB / ft	Watts
1.0	0.68	0.20	100
2.0	0.98	0.30	71
3.0	1.22	0.37	58
6.0	1.80	0.54	41
8.0	2.12	0.64	35
10.0	2.41	0.73	32
12.4	2.73	0.83	28
18.0	3.41	1.03	24
20.0	3.64	1.10	22
Attenuation calculation (dB/m)	[0.635 x √f GHz] + [0.04 x f GHz]		
Power calculation (W)	100 / √f GHz		

⁽¹⁾ SPCCS = Silver Plated Copper Covered Steel
⁽²⁾ PTFE = PolyTetraFluoroEthylene
⁽³⁾ TPAI = Tin Plated Aluminum

Note:

Typical attenuation for a couple of connectors (dB) = 0.045 x √f (GHz)

Hand-formable cable .141 (Unjacketed)



P/N: C291 864 065

APPLICATION NOTE

This handformable cable is an alternative to RG402 for applications requiring an easy routing on equipment.
 Due to the outer conductor construction, this cable can be hand formed with exceptional ease with no spring back effect.
 The cable can be reshaped, eliminating the need for costly drawings.
 Attenuation is a little bit higher than RG402 but the temperature range is wider.

CONSTRUCTION / DIMENSIONS

	Material	mm	Inches
Center conductor	Solid SPCCS ⁽¹⁾	0.92	0.036
Dielectric	Solid PTFE ⁽²⁾	2.95	0.116
Inner shield	Copper tape	-	-
Outer shield	TS ⁽³⁾ braid	3.50	0.138
Jacket	-	-	-

ELECTRICAL CHARACTERISTICS

Characteristic impedance	50Ω ± 2Ω	
Operating frequency range	DC - 20 GHz	
Shielding effectiveness	90 dB	
Voltage withstanding	5 000 V rms	
Peak power	3.4 kW	
Capacitance	97.5 pF / m	29.5 pF / ft
Velocity of propagation	70 % (4.8 ns / m)	

MECHANICAL CHARACTERISTICS

Recommended minimum bending radius	6.4 ⁽⁴⁾ / 19 ⁽⁵⁾ mm	0.25 ⁽⁴⁾ / 0.75 ⁽⁵⁾ inch
Weight	33 g / m	0.0221 lbs / ft

ENVIRONMENTAL CHARACTERISTICS

Operating temperature range	-65 / +150 °C	-85 / +302 °F
Fire resistance	not applicable	
Halogen free	no	

FREQUENCY / ATTENUATION (typ.) / CW MAX POWER (sea level / 25 °C)

GHz	dB / m	dB / ft	Watts
1.0	0.39	0.12	315
2.0	0.57	0.17	223
3.0	0.72	0.22	182
6.0	1.09	0.33	129
8.0	1.30	0.39	111
10.0	1.49	0.45	100
12.4	1.71	0.52	89
18.0	2.18	0.66	74
20.0	2.34	0.71	70
Attenuation calculation (dB/m)	[0.345 x √f GHz] + [0.04 x f GHz]		
Power calculation (W)	315 / √f GHz		

⁽¹⁾ SPCCS = Silver Plated Copper Covered Steel
⁽²⁾ PTFE = PolyTetraFluoroEthylene
⁽³⁾ TS = Tin Soaked
⁽⁴⁾ one time
⁽⁵⁾ repeated

Hand-formable cable .141 (Jacketed)



P/N: C291 866 378

APPLICATION NOTE

This jacketed cable will be used instead of standard unjacketed .141 for applications requiring electrical insulation and/or protection against environmental aggressions (chemical, humidity...).

The FEP jacket allows this cable to be used under severe thermal conditions.

The jacket slightly increases the spring back effect.

CONSTRUCTION / DIMENSIONS

	Material	mm	Inches
Center conductor	Solid SPC ⁽¹⁾	0.92	0.036
Dielectric	Solid PTFE ⁽²⁾	2.98	0.117
Inner shield	TS ⁽³⁾ braid	3.50	0.138
Outer shield	-	-	-
Jacket	Black FEP ⁽⁴⁾	4.05	0.159

ELECTRICAL CHARACTERISTICS

Characteristic impedance	50Ω ± 2Ω	
Operating frequency range	DC - 20 GHz	
Shielding effectiveness	90 dB	
Voltage withstanding	5 000 V rms	
Peak power	3.4 kW	
Capacitance	97.5 pF / m	29.5 pF / ft
Velocity of propagation	70 % (4.8 ns / m)	

MECHANICAL CHARACTERISTICS

Recommended minimum bending radius	11 ⁽⁵⁾ / 33 ⁽⁶⁾ mm	0.43 ⁽⁵⁾ / 1.3 ⁽⁶⁾ inch
Weight	38 g / m	0.0254 lbs / ft

ENVIRONMENTAL CHARACTERISTICS

Operating temperature range	-65 / +150 °C	-85 / +302 °F
Fire resistance	yes (CSA FT6 / IEC 332-2)	
Halogen free	no	

FREQUENCY / ATTENUATION (typ.) / CW MAX POWER (sea level / 25 °C)

GHz	dB / m	dB / ft	Watts
1.0	0.43	0.13	315
2.0	0.63	0.19	223
3.0	0.80	0.24	182
6.0	1.20	0.36	129
8.0	1.42	0.43	111
10.0	1.63	0.49	100
12.4	1.87	0.57	89
18.0	2.37	0.72	74
20.0	2.54	0.77	70
Attenuation calculation (dB/m)	[0.390 x √f GHz] + [0.04 x f GHz]		
Power calculation (W)	315 / √f GHz		

⁽¹⁾ SPC = Silver Plated Copper

⁽²⁾ PTFE = PolyTetraFluoroEthylene

⁽³⁾ TS = Tin Soaked

⁽⁴⁾ FEP = Fluorinated Ethylene Propylene

⁽⁵⁾ one time

⁽⁶⁾ repeated

Note:

Typical attenuation for a couple of connectors (dB) = 0.045 x √f (GHz)

Semi-rigid cable .141 (RG402 - KS2)



P/N: C291 860 001

(MIL-C-17/130-RG402)

(NF-C-93/551-KS2)

APPLICATION NOTE

RG402 is one of the most popular semi-rigid RG cables.

RG402 will be preferred to flexible RG142 for applications requiring high frequency range, low attenuation, high screening effectiveness, very small bending radius and/or no spring back effect.

CONSTRUCTION / DIMENSIONS

	Material	mm	Inches
Center conductor	Solid SPCCS ⁽¹⁾	0.92	0.036
Dielectric	Solid PTFE ⁽²⁾	2.98	0.117
Inner shield	Copper tubing	3.58	0.141
Outer shield	-	-	-
Jacket	-	-	-

ELECTRICAL CHARACTERISTICS

Characteristic impedance	50Ω ± 1Ω	
Operating frequency range	DC - 20 GHz	
Shielding effectiveness	110 dB	
Voltage withstanding	5 000 V rms	
Peak power	3.4 kW	
Capacitance	89 pF / m	27 pF / ft
Velocity of propagation	70 % (4.8 ns / m)	

MECHANICAL CHARACTERISTICS

Recommended minimum bending radius	6.35 mm	0.250 inch
Weight	46 g / m	0.0309 lbs / ft

ENVIRONMENTAL CHARACTERISTICS

Operating temperature range	-40 / +125 °C	-40 / +257 °F
Fire resistance	not applicable	
Halogen free	no	

FREQUENCY / ATTENUATION (typ.) / CW MAX POWER (sea level / 25 °C)

GHz	dB / m	dB / ft	Watts
1.0	0.34	0.10	315
2.0	0.50	0.15	223
3.0	0.64	0.19	182
6.0	0.97	0.30	129
8.0	1.17	0.35	111
10.0	1.35	0.41	100
12.4	1.55	0.47	89
18.0	1.99	0.60	74
20.0	2.14	0.65	70
Attenuation calculation (dB/m)	[0.30 x √f GHz] + [0.04 x f GHz]		
Power calculation (W)	315 / √f GHz		

⁽¹⁾ SPCCS = Silver Plated Copper Covered Steel

⁽²⁾ PTFE = PolyTetraFluoroEthylene

Semi-rigid cable .141 (Tinned copper)



**P/N: C291 862 005
(MIL-C-17/130-00005)**

APPLICATION NOTE

Due to the outer conductor coating (tin), this cable will be used instead of RG402 for applications requiring high corrosion resistance and improved solderability. This cable is also an economical alternative to .141 silvered copper.

CONSTRUCTION / DIMENSIONS

	Material	mm	Inches
Center conductor	Solid SPCCS ⁽¹⁾	0.92	0.036
Dielectric	Solid PTFE ⁽²⁾	2.98	0.117
Inner shield	TPC ⁽³⁾	3.58	0.141
Outer shield	-	-	-
Jacket	-	-	-

ELECTRICAL CHARACTERISTICS

Characteristic impedance	50Ω ± 1Ω	
Operating frequency range	DC - 20 GHz	
Shielding effectiveness	110 dB	
Voltage withstanding	5 000 V rms	
Peak power	3.4 kW	
Capacitance	89 pF / m	27 pF / ft
Velocity of propagation	70 % (4.8 ns / m)	

MECHANICAL CHARACTERISTICS

Recommended minimum bending radius	1.90 mm	0.075 inch
Weight	46 g / m	0.0309 lbs / ft

ENVIRONMENTAL CHARACTERISTICS

Operating temperature range	-40 / +125 °C	-40 / +257 °F
Fire resistance	not applicable	
Halogen free	no	

**FREQUENCY / ATTENUATION (typ.) /
CW MAX POWER (sea level / 25 °C)**

GHz	dB / m	dB / ft	Watts
1.0	0.34	0.10	315
2.0	0.50	0.15	223
3.0	0.64	0.19	182
6.0	0.97	0.30	129
8.0	1.17	0.35	111
10.0	1.35	0.41	100
12.4	1.55	0.47	89
18.0	1.99	0.60	74
20.0	2.14	0.65	70
Attenuation calculation (dB/m)	[0.30 x √f GHz] + [0.04 x f GHz]		
Power calculation (W)	315 / √f GHz		

⁽¹⁾ SPCCS = Silver Plated Copper Covered Steel

⁽²⁾ PTFE = PolyTetraFluoroEthylene

⁽³⁾ TPC = Tin Plated Copper

Note:

Typical attenuation for a couple of connectors (dB) = 0.045 x √f (GHz)

Semi-rigid cable .141 (Silvered copper)



P/N: C291 861 066

APPLICATION NOTE

Based on RG402 standard, this cable is used where non magnetic is required.

In addition, due to the outer conductor coating (silver), this cable will be used instead of RG402 for applications requiring high corrosion resistance and improved solderability.

CONSTRUCTION / DIMENSIONS

	Material	mm	Inches
Center conductor	Solid SPC ⁽¹⁾	0.92	0.036
Dielectric	Solid PTFE ⁽²⁾	2.98	0.117
Inner shield	SPC ⁽¹⁾ tubing	3.58	0.141
Outer shield	-	-	-
Jacket	-	-	-

ELECTRICAL CHARACTERISTICS

Characteristic impedance	50Ω ± 1Ω	
Operating frequency range	DC - 20 GHz	
Shielding effectiveness	110 dB	
Voltage withstanding	5 000 V rms	
Peak power	3.4 kW	
Capacitance	89 pF / m	27 pF / ft
Velocity of propagation	70 % (4.8 ns / m)	

MECHANICAL CHARACTERISTICS

Recommended minimum bending radius	1.90 mm	0.075 inch
Weight	46 g / m	0.0309 lbs / ft

ENVIRONMENTAL CHARACTERISTICS

Operating temperature range	-40 / +125 °C	-40 / +257 °F
Fire resistance	not applicable	
Halogen free	no	

**FREQUENCY / ATTENUATION (typ.) /
CW MAX POWER (sea level / 25 °C)**

GHz	dB / m	dB / ft	Watts
1.0	0.34	0.10	315
2.0	0.50	0.15	223
3.0	0.64	0.19	182
6.0	0.97	0.30	129
8.0	1.17	0.35	111
10.0	1.35	0.41	100
12.4	1.55	0.47	89
18.0	1.99	0.60	74
20.0	2.14	0.65	70
Attenuation calculation (dB/m)	[0.30 x √f GHz] + [0.04 x f GHz]		
Power calculation (W)	315 / √f GHz		

⁽¹⁾ SPC = Silver Plated Copper

⁽²⁾ PTFE = PolyTetraFluoroEthylene

Semi-rigid cable .141 (Non magnetic)



P/N: C291 861 061

APPLICATION NOTE

Based on RG402 standard, this cable is used where non magnetic is required.

CONSTRUCTION / DIMENSIONS

	Material	mm	Inches
Center conductor	Solid SPC ⁽¹⁾	0.92	0.036
Dielectric	Solid PTFE ⁽²⁾	2.98	0.117
Inner shield	Copper tubing	3.58	0.141
Outer shield	-	-	-
Jacket	-	-	-

ELECTRICAL CHARACTERISTICS

Characteristic impedance	50Ω ± 1Ω	
Operating frequency range	DC - 20 GHz	
Shielding effectiveness	110 dB	
Voltage withstanding	5 000 V rms	
Peak power	3.4 kW	
Capacitance	89 pF / m	27 pF / ft
Velocity of propagation	70 % (4.8 ns / m)	

MECHANICAL CHARACTERISTICS

Recommended minimum bending radius	2.54 mm	0.100 inch
Weight	46 g / m	0.0309 lbs / ft

ENVIRONMENTAL CHARACTERISTICS

Operating temperature range	-40 / +125 °C	-40 / +257 °F
Fire resistance	not applicable	
Halogen free	no	

FREQUENCY / ATTENUATION (typ.) / CW MAX POWER (sea level / 25 °C)

GHz	dB / m	dB / ft	Watts
1.0	0.34	0.10	315
2.0	0.50	0.15	223
3.0	0.64	0.19	182
6.0	0.97	0.30	129
8.0	1.17	0.35	111
10.0	1.35	0.41	100
12.4	1.55	0.47	89
18.0	1.99	0.60	74
20.0	2.14	0.65	70
Attenuation calculation (dB/m)	[0.30 x √f GHz] + [0.04 x f GHz]		
Power calculation (W)	315 / √f GHz		

⁽¹⁾ SPC = Silver Plated Copper

⁽²⁾ PTFE = PolyTetraFluoroEthylene

Note:

Typical attenuation for a couple of connectors (dB) = 0.045 x √f (GHz)

Semi-rigid cable .141 (Aluminum)



P/N: C291 864 187

(MIL-C-17/130-00009)

APPLICATION NOTE

Based on RG402 standard, this cable will be selected for application requiring easy conformability and/or application requiring reduced weight.

Due to the aluminum outer conductor, this cable can be hand formed with exceptional ease with no spring back effect.

Cable can be reshaped, eliminating the need for costly drawings. The outer conductor material (aluminum) slightly increases the attenuation compared to standard RG402.

CONSTRUCTION / DIMENSIONS

	Material	mm	Inches
Center conductor	Solid SPCCS ⁽¹⁾	0.92	0.036
Dielectric	Solid PTFE ⁽²⁾	2.98	0.117
Inner shield	TPA ⁽³⁾	3.58	0.141
Outer shield	-	-	-
Jacket	-	-	-

ELECTRICAL CHARACTERISTICS

Characteristic impedance	50Ω ± 1Ω	
Operating frequency range	DC - 20 GHz	
Shielding effectiveness	110 dB	
Voltage withstanding	5 000 V rms	
Peak power	3.4 kW	
Capacitance	89 pF / m	27 pF / ft
Velocity of propagation	70 % (4.8 ns / m)	

MECHANICAL CHARACTERISTICS

Recommended minimum bending radius	3.17 mm	0.125 inch
Weight	30 g / m	0.0185 lbs / ft

ENVIRONMENTAL CHARACTERISTICS

Operating temperature range	-40 / +125 °C	-40 / +257 °F
Fire resistance	not applicable	
Halogen free	no	

FREQUENCY / ATTENUATION (typ.) / CW MAX POWER (sea level / 25 °C)

GHz	dB / m	dB / ft	Watts
1.0	0.36	0.11	315
2.0	0.53	0.16	223
3.0	0.67	0.20	182
6.0	1.02	0.31	129
8.0	1.23	0.37	111
10.0	1.41	0.43	100
12.4	1.62	0.49	89
18.0	2.08	0.63	74
20.0	2.23	0.68	70
Attenuation calculation (dB/m)	[0.32 x √f GHz] + [0.04 x f GHz]		
Power calculation (W)	315 / √f GHz		

⁽¹⁾ SPCCS = Silver Plated Copper Covered Steel

⁽²⁾ PTFE = PolyTetraFluoroEthylene

⁽³⁾ TPA = Tin Plated Aluminum

Semi-rigid cable .250 (RG401 - KS3)



**P/N: C291 870 001
(MIL-C-17/129-RG401)
(NF-C-93/551-KS3)**

APPLICATION NOTE

RG401 will be used for application requiring very low attenuation, high power and high screening effectiveness.

Note: reduced operating temperature range.

CONSTRUCTION / DIMENSIONS

	Material	mm	Inches
Center conductor	Solid SPC ⁽¹⁾	1.63	0.064
Dielectric	Solid PTFE ⁽²⁾	5.31	0.209
Inner shield	Copper tubing	6.35	0.250
Outer shield	-	-	-
Jacket	-	-	-

ELECTRICAL CHARACTERISTICS

Characteristic impedance	50Ω ± 0.5Ω	
Operating frequency range	DC - 18 GHz	
Shielding effectiveness	110 dB	
Voltage withstanding	7 500 V rms	
Peak power	6.1 kW	
Capacitance	89 pF / m	27 pF / ft
Velocity of propagation	70 % (4.8 ns / m)	

MECHANICAL CHARACTERISTICS

Recommended minimum bending radius	9.53 mm	0.375 inch
Weight	140 g / m	0.0945 lbs / ft

ENVIRONMENTAL CHARACTERISTICS

Operating temperature range	-40 / +90 °C	-40 / +194 °F
Fire resistance	not applicable	
Halogen free	no	

FREQUENCY / ATTENUATION (typ.) / CW MAX POWER (sea level / 25 °C)

GHz	dB / m	dB / ft	Watts
1.0	0.21	0.06	900
2.0	0.31	0.09	636
3.0	0.41	0.12	520
6.0	0.64	0.20	367
8.0	0.79	0.24	318
10.0	0.92	0.28	285
12.4	1.08	0.33	256
18.0	1.42	0.43	212
20.0	1.54	0.47	201
Attenuation calculation (dB/m)	[0.165 x √f GHz] + [0.04 x f GHz]		
Power calculation (W)	900 / √f GHz		

⁽¹⁾ SPC = Silver Plated Copper

⁽²⁾ PTFE = PolyTetraFluoroEthylene

Semi-rigid cable .250 (Aluminum)



P/N: C291 874 187

APPLICATION NOTE

Based on RG401 standard, this cable will be selected for application requiring easy conformability and/or application requiring reduced weight.

Due to the aluminum outer conductor, this cable can be hand formed with exceptional ease with no spring back effect.

Cable can be reshaped, eliminating the need for costly drawings.

The outer conductor material (aluminum) slightly increases the attenuation compared to standard RG401.

CONSTRUCTION / DIMENSIONS

	Material	mm	Inches
Center conductor	Solid SPC ⁽¹⁾	1.63	0.064
Dielectric	Solid PTFE ⁽²⁾	5.31	0.209
Inner shield	TPAL ⁽³⁾ tubing	6.35	0.250
Outer shield	-	-	-
Jacket	-	-	-

ELECTRICAL CHARACTERISTICS

Characteristic impedance	50Ω ± 1Ω	
Operating frequency range	DC - 18 GHz	
Shielding effectiveness	110 dB	
Voltage withstanding	7 500 V rms	
Peak power	6.1 kW	
Capacitance	89 pF / m	27 pF / ft
Velocity of propagation	70 % (4.8 ns / m)	

MECHANICAL CHARACTERISTICS

Recommended minimum bending radius	9.53 mm	0.375 inch
Weight	79.5 g / m	0.0530 lbs / ft

ENVIRONMENTAL CHARACTERISTICS

Operating temperature range	-40 / +100 °C	-40 / +212 °F
Fire resistance	not applicable	
Halogen free	no	

FREQUENCY / ATTENUATION (typ.) / CW MAX POWER (sea level / 25 °C)

GHz	dB / m	dB / ft	Watts
1.0	0.22	0.07	550
2.0	0.33	0.10	389
3.0	0.43	0.13	318
6.0	0.68	0.21	225
8.0	0.83	0.25	194
10.0	0.97	0.29	174
12.4	1.13	0.34	156
18.0	1.48	0.45	130
20.0	1.60	0.49	123
Attenuation calculation (dB/m)	[0.18 x √f GHz] + [0.04 x f GHz]		
Power calculation (W)	550 / √f GHz		

⁽¹⁾ SPC = Silver Plated Copper

⁽²⁾ PTFE = PolyTetraFluoroEthylene

⁽³⁾ TPAL = Tin Plated Aluminum

Note:

Typical attenuation for a couple of connectors (dB) = 0.045 x √f (GHz)

**Low loss flexible cable 2.6/50 S+F
(AEP-100FR alternative to LMR-100FR®)**



P/N: C291 327 060

APPLICATION NOTE

AEP-100FR cable is an alternative solution to 50 Ohms LMR-100FR® cable offering the same performance and similar construction with cost advantage.

REGULATIONS

RoHS compliant
UL/NEC: CMR
UL/CSA: FT4

**CONNECTORS COMPATIBLE
WITH AEP-100FR
(and to LMR® 100FR)**

QMA Series

P/N	Interface	Model
R123 071 000	Straight plug	Crimp type

SMA Series

P/N	Interface	Model
R124 071 123	Straight plug	Crimp type
R124 172 123	R/A plug	Crimp type
R124 312 123	Straight BH jack	Crimp type

TNC Series

P/N	Interface	Model
R143 075 000	Straight plug	Crimp type

N Series

P/N	Interface	Model
R161 072 000	Straight plug	Crimp type

⁽¹⁾ BC = Bare Copper

⁽²⁾ PE = PolyEthylene

CONSTRUCTION / DIMENSIONS

	Material	mm	Inches
Center conductor	Solid BC ⁽¹⁾	0.46	0.018
Dielectric	Solid PE ⁽²⁾	1.52	0.06
Inner shield	Al Tape Unbonded	1.65	0.065
Outer shield	Tinned Copper braid	2.11	0.083
Outer jacket	Black LSZH	2.79	0.11

ELECTRICAL CHARACTERISTICS

Characteristic impedance	50 ohms	
Operating frequency range	DC - 6 GHz	
Dielectric constant	2.3	
Screening effectiveness	> 90 dB	
Velocity of propagation	66 %	
Capacitance	101.1 pF / m	30.8 pF / ft
Inductance	0.25 uH / m	0.077 uH / ft
Time delay	5.05 nS / m	1.54 nS / ft
Inner conductor DC resistance	266 ohms / km	81.0 ohms / 1000 ft
Outer conductor DC resistance	31.2 ohms / km	9.5 ohms / 1000 ft
Voltage withstand	500 Volts DC	
Jacket spark	2000 Volts RMS	
Peak power	0.6kW	
Phase stability over temp	< 25 ppm / deg C	

MECHANICAL CHARACTERISTICS

Maximum weight	14 g / m	0.092 lb / ft
Min. bend radius: installation	6.4 mm	0.25 inch
Min. bend radius: repeated	25.4 mm	1.0 inch
Bending moment	0.014 N-m	0.1 ft-lb
Tensile strength	6.8 kg	15 lb
Flat plate crush	0.18 kg / mm	10 lb / inch

ENVIRONMENTAL CHARACTERISTICS

Installation temperature range	-40 / +85 °C	-40 / +185 °F
Storage temperature range	-70 / +85 °C	-94 / +185 °F
Operating temperature range	-40 / +85 °C	-40 / +185 °F

**FREQUENCY / ATTENUATION (typ.) /
AVG POWER (*)**

MHz	DB / 100 m	DB / 100 ft	kW
30	12.9	3.9	0.230
50	16.7	5.1	0.180
150	29.4	8.9	0.100
220	35.8	10.9	0.083
450	51.9	15.8	0.057
900	74.9	22.8	0.039
1500	98.7	30.1	0.029
1800	109.0	33.2	0.027
2000	115.5	35.2	0.025
2500	130.6	39.8	0.022
5800	210.3	64.1	0.013

^(*) = Avg power calculated at sea level / 40°C and VSWR 1:0
(Cable-assembly power ratings may be limited by the connector type. Please contact us for specific needs)

**Flexible low loss cable 5/50 S+F
(AEP-195FR alternative to LMR-195FR®)**



P/N: C291 327 010

APPLICATION NOTE

AEP-195FR cable is an alternative solution to 50 Ohms LMR-195FR® cable offering the same performance and similar construction with cost advantage.

REGULATIONS

RoHS compliant
UL/NEC:CMR
UL/CSA: FT4

**CONNECTORS COMPATIBLE
WITH AEP-195FR
(and to LMR® 195FR)**

QMA Series

P/N	Interface	Model
R123 075 200	Straight plug	Crimp type

SMA Series

P/N	Interface	Model
R124 075 210	Straight plug	Crimp type
R124 175 110	R/A plug	Crimp type

TNC Series

P/N	Interface	Model
R143 082 027	Straight plug	Crimp type

N Series

P/N	Interface	Model
R161 082 120	Straight plug	Crimp type

⁽¹⁾ BC = Bare Copper

⁽²⁾ PE = PolyEthylene

CONSTRUCTION / DIMENSIONS

	Material	mm	Inches
Center conductor	Solid BC ⁽¹⁾	0.94	0.037
Dielectric	Foam PE ⁽²⁾	2.79	0.11
Inner shield	Aluminum Tape	2.95	0.116
Outer shield	Tinned Copper braid	3.53	0.139
Outer jacket	Black LSZH	4.95	0.195

ELECTRICAL CHARACTERISTICS

Characteristic impedance	50 ohms	
Operating frequency range	DC - 6 GHz	
Dielectric constant	1.56	
Screening effectiveness	> 90 dB	
Velocity of propagation	76 %	
Capacitance	83.3 pF / m	25.4 pF / ft
Inductance	0.21 uH / m	0.064 uH / ft
Time delay	4.17 nS / m	1.27 nS / ft
Inner conductor DC resistance	24.9 ohms / km	7.6 ohms / 1000 ft
Outer conductor DC resistance	16.1 ohms / km	4.9 ohms / 1000 ft
Voltage withstand	1000 Volts DC	
Jacket spark	3000 Volts RMS	
Peak power	2.5kW	
Phase stability over temp	< 25 ppm / deg C	

MECHANICAL CHARACTERISTICS

Maximum weight	30 g / m	0.021 lb / ft
Min. bend radius: installation	12.7 mm	0.5 inch
Min. bend radius: repeated	50.8 mm	2.0 inch
Bending moment	0.27 N-m	0.2 ft-lb
Tensile strength	18.2 kg	40 lb
Flat plate crush	0.27 kg / mm	15 lb / inch

ENVIRONMENTAL CHARACTERISTICS

Installation temperature range	-40 / +85 °C	-40 / +185 °F
Storage temperature range	-70 / +85 °C	-94 / +185 °F
Operating temperature range	-40 / +85 °C	-40 / +185 °F

**FREQUENCY / ATTENUATION (typ.) /
AVG POWER (*)**

MHz	DB / 100 m	DB / 100 ft	kW
30	6.5	2.0	0.89
50	8.4	2.5	0.68
150	14.6	4.4	0.39
220	17.7	5.4	0.32
450	25.5	7.8	0.22
900	36.5	11.1	0.16
1500	47.7	14.5	0.12
1800	52.5	16.0	0.11
2000	55.4	16.9	0.10
2500	62.4	19.0	0.09
5800	98.1	29.9	0.06

^(*) = Avg power calculated at sea level / 40°C and VSWR 1:0

(Cable-assembly power ratings may be limited by the connector type. Please contact us for specific needs)

**Low loss Flexible cable 5/50 S+F
(AEP-200FR alternative to LMR-200FR®)**



P/N: C291 327 020

APPLICATION NOTE

AEP-200FR cable is an alternative solution to 50 Ohms LMR-200FR® cable offering the same performance and similar construction with cost advantage.

REGULATIONS

RoHS compliant
UL/NEC: CMR
UL/CSA: FT4

**CONNECTORS COMPATIBLE
WITH AEP-200FR
(and to LMR® 200FR)**

QMA Series

P/N	Interface	Model
R123 096 110	Straight plug	Crimp type

SMA Series

P/N	Interface	Model
R124 076 450	Straight plug	Crimp type
R124 175 200	R/A plug	Crimp type

TNC Series

P/N	Interface	Model
R143 082 200	Straight plug	Crimp type

N Series

P/N	Interface	Model
R161 082 200	Straight plug	Crimp type
R161 182 080	R/A plug	Crimp type
R161 329 130	Straight BH jack	Crimp type

CONSTRUCTION / DIMENSIONS

	Material	mm	Inches
Center conductor	Solid BC ⁽¹⁾	1.12	0.044
Dielectric	Foam PE ⁽²⁾	2.95	0.116
Inner shield	Aluminum Tape	3.07	0.121
Outer shield	Tinned Copper braid	3.66	0.144
Outer jacket	Black LSZH	4.95	0.195

ELECTRICAL CHARACTERISTICS

Characteristic impedance	50 ohms	
Operating frequency range	DC - 6 GHz	
Dielectric constant	1.45	
Screening effectiveness	> 90 dB	
Velocity of propagation	83 %	
Capacitance	80.3 pF / m	24.5 pF / ft
Inductance	0.20 uH / m	0.061 uH / ft
Time delay	4.02 nS / m	1.22 nS / ft
Inner conductor DC resistance	17.6 ohms / km	5.36 ohms / 1000 ft
Outer conductor DC resistance	16.1 ohms / km	4.9 ohms / 1000 ft
Voltage withstand	1000 Volts DC	
Jacket spark	3000 Volts RMS	
Peak power	2.5kW	
Phase stability over temp	< 25 ppm / deg C	

MECHANICAL CHARACTERISTICS

Maximum weight	30 g / m	0.022 lb / ft
Min. bend radius: installation	12.7 mm	0.5 inch
Min. bend radius: repeated	50.8 mm	2.0 inch
Bending moment	0.27 N-m	0.2 ft-lb
Tensile strength	18.2 kg	40 lb
Flat plate crush	0.27 kg / mm	15 lb / inch

ENVIRONMENTAL CHARACTERISTICS

Installation temperature range	-40 / +85 °C	-40 / +185 °F
Storage temperature range	-70 / +85 °C	-94 / +185 °F
Operating temperature range	-40 / +85 °C	-40 / +185 °F

**FREQUENCY / ATTENUATION (typ.) /
AVG POWER^(*)**

MHz	DB / 100 m	DB / 100 ft	kW
30	5.8	1.8	1.02
50	7.5	2.3	0.79
150	13.1	4.0	0.45
220	15.9	4.8	0.37
450	22.8	7.0	0.26
900	32.6	9.9	0.18
1500	42.4	12.9	0.14
1800	46.6	14.2	0.13
2000	49.3	15.0	0.12
2500	55.4	16.9	0.11
5800	86.5	26.4	0.07

^(*) = Avg power calculated at sea level / 40°C and VSWR 1:0
(Cable-assembly power ratings may be limited by the connector type.
Please contact us for specific needs)

**Flexible low loss cable 6.1/50 S+F
(AEP-240FR alternative to LMR-240FR®)**



P/N: C291 327 030

APPLICATION NOTE

AEP-240FR cable is an alternative solution to 50 Ohms LMR-240FR® cable offering the same performance and similar construction with cost advantage.

REGULATIONS

RoHS compliant
UL/NEC: CMR
UL/CSA: FT4

**CONNECTORS COMPATIBLE
WITH AEP-240FR
(and to LMR® 240FR)**

QMA Series

P/N	Interface	Model
R123 076 310	Straight plug	Crimp type
R123 177 100	R/a plug	Crimp type
R123 314 010	Straight bh jack	Crimp type
R123W 076 310	Wp straight plug	Crimp type
R123W 177 110	Wp r/a plug	Crimp type

SMA Series

P/N	Interface	Model
R124 076 430	Straight plug	Crimp type
R124 175 310	R/A plug	Crimp type

TNC Series

P/N	Interface	Model
R143 084 161	Straight plug	Crimp type

N Series

P/N	Interface	Model
R161 075 030	Straight plug	Crimp type
R161 183 310	R/A plug	Crimp type
R161 329 140	Straight bh jack	Crimp type

QN Series

P/N	Interface	Model
R164 075 010	Straight plug	Crimp type

7/16 Series

P/N	Interface	Model
R185 085 007	Straight plug	Crimp type
R185 320 020	Straight BH jack	Crimp type

⁽¹⁾ BC = Bare Copper

⁽²⁾ PE = PolyEt hylene

CONSTRUCTION / DIMENSIONS

	Material	mm	Inches
Center conductor	Solid BC ⁽¹⁾	1.42	0.056
Dielectric	Foam PE ⁽²⁾	3.81	0.15
Inner shield	Aluminum Tape	3.94	0.155
Outer shield	Tinned Copper braid	4.52	0.178
Outer jacket	Black LSZH	6.1	0.24

ELECTRICAL CHARACTERISTICS

Characteristic impedance	50 ohms	
Operating frequency range	DC - 6 GHz	
Dielectric constant	1.42	
Screening effectiveness	> 90 dB	
Velocity of propagation	84 %	
Capacitance	79.4 pF / m	24.2 pF / ft
Inductance	0.20 uH / m	0.060 uH / ft
Time delay	3.97 nS / m	1.21 nS / ft
Inner conductor dc resistance	10.5 ohms / km	3.2 ohms / 1000 ft
Outer conductor dc resistance	12.8 ohms / km	3.89 ohms / 1000 ft
Voltage withstand	1500 Volts DC	
Jacket spark	5000 Volts RMS	
Peak power	5.6kW	
Phase stability over temp	< 25 ppm / deg C	

MECHANICAL CHARACTERISTICS

Maximum weight	0.05 kg / m	0.034 lb / ft
Min. bend radius: installation	19.1 mm	0.75 inch
Min. bend radius: repeated	63.5 mm	2.5 inch
Bending moment	0.34 N-m	0.25 ft-lb
Tensile strength	36.3 kg	80 lb
Flat plate crush	0.36 kg / mm	20 lb / inch

ENVIRONMENTAL CHARACTERISTICS

Installation temperature range	-40 / +85 °C	-40 / +185 °F
Storage temperature range	-70 / +85 °C	-94 / +185 °F
Operating temperature range	-40 / +85 °C	-40 / +185 °F

**FREQUENCY / ATTENUATION (typ.) /
AVG POWER (*)**

MHz	DB / 100 m	DB / 100 ft	kW
30	4.4	1.3	1.49
50	5.7	1.7	1.15
150	9.9	3.0	0.66
220	12.0	3.7	0.54
450	17.3	5.3	0.38
900	24.8	7.6	0.26
1500	32.4	9.9	0.20
1800	35.6	10.9	0.18
2000	37.7	11.5	0.17
2500	42.4	12.9	0.15
5800	66.8	20.4	0.10

^(*) = Avg power calculated at sea level / 40°C and VSWR 1:0

[Cable-assembly power ratings may be limited by the connector type. Please contact us for specific needs]

**Low loss Flexible cable 10.3/50 S+F
(AEP-400FR alternative to LMR-400FR®)**



P/N: C291 .327 040

APPLICATION NOTE

AEP-400FR cable is an alternative solution to 50 Ohms LMR-400FR® cable offering the same performance and similar construction with cost advantage.

REGULATIONS

RoHS compliant
UL/NEC: CMR
UL/CSA: FT4

**CONNECTORS COMPATIBLE
WITH AEP-400FR
(and to LMR® 400FR)**

SMA Series

P/N	Interface	Model
R124 080 030	Straight plug	Crimp type

TNC Series

P/N	Interface	Model
R143 089 117	Straight plug	Crimp type

N Series

P/N	Interface	Model
R161 088 180	Straight plug	Crimp type
R161 184 080	R/A plug	Crimp type
R161 331 060	Straight bh jack	Crimp type

QN Series

P/N	Interface	Model
R164 080 020	Straight plug	Crimp type
R164 185 007	R/A plug	Crimp type
R164 241 020	Straight bh jack	Crimp type

7/16 Series

P/N	Interface	Model
R185 085 007	Straight plug	Crimp type
R185 320 020	Straight BH jack	Crimp type

⁽¹⁾ BC = Bare Copper
⁽²⁾ PE = PolyEt hylene

CONSTRUCTION / DIMENSIONS

	Material	mm	Inches
Center conductor	Solid BCCAL ⁽¹⁾	2.74	0.108
Dielectric	Foam PE ⁽²⁾	7.24	0.285
Inner shield	Aluminum Tape	7.39	0.291
Outer shield	Tinned Copper braid	8.13	0.32
Outer jacket	Black LSZH	10.29	0.405

ELECTRICAL CHARACTERISTICS

Characteristic impedance	50 ohms	
Cut-off frequency	16 GHz	
Dielectric constant	1.38	
Screening effectiveness	> 90 dB	
Velocity of propagation	85 %	
Capacitance	78.4 pF / m	23.9 pF / ft
Inductance	0.20 uH / m	0.060 uH / ft
Time delay	3.97 nS / m	1.21 nS / ft
Inner conductor DC resistance	4.6 ohms / km	1.39 ohms / 1000 ft
Outer conductor DC resistance	5.4 ohms / km	1.65 ohms / 1000 ft
Voltage withstand	2500 Volts DC	
Jacket spark	8000 Volts RMS	
Peak power	16kW	
Phase stability over temp	< 25 ppm / deg C	

MECHANICAL CHARACTERISTICS

Maximum weight	0.10 kg / m	0.068 lb / ft
Min. bend radius: installation	25.4 mm	1.00 inch
Min. bend radius: repeated	101.6 mm	4.0 inch
Bending moment	0.68 N-m	0.5 ft-lb
Tensile strength	72.6 kg	160 lb
Flat plate crush	0.71 kg / mm	40 lb / inch

ENVIRONMENTAL CHARACTERISTICS

Installation temperature range	-40 / +85 °C	-40 / +185 °F
Storage temperature range	-70 / +85 °C	-94 / +185 °F
Operating temperature range	-40 / +85 °C	-40 / +185 °F

**FREQUENCY / ATTENUATION (typ.) /
AVG POWER ^(*)**

MHz	DB / 100 m	DB / 100 ft	kW
30	2.2	0.7	3.33
50	2.9	0.9	2.57
150	5.0	1.5	1.47
220	6.1	1.9	1.20
450	8.9	2.7	0.83
900	12.8	3.9	0.58
1500	16.8	5.1	0.44
1800	18.6	5.7	0.40
2000	19.6	6.0	0.37
2500	22.2	6.8	0.33
5800	35.5	10.8	0.21

^(*) = Avg power calculated at sea level / 40°C and VSWR 1:0
[Cable-assembly power ratings may be limited by the connector type. Please contact us for specific needs]

**Flexible low loss cable 15/50 S+F
(AEP-600FR alternative to LMR-600FR®)**



P/N: C291 327 050

APPLICATION NOTE

AEP-600FR cable is an alternative solution to 50 Ohms LMR-600FR® cable offering the same performance and similar construction with cost advantage.

REGULATIONS

RoHS compliant
UL/NEC: CMR
UL/CSA: FT4

**CONNECTORS COMPATIBLE
WITH AEP-600FR
(and to LMR® 600FR)**

N Series

P/N	Interface	Model
R161 079 200	Straight plug	Crimp type
R161 188 200	R/A plug	Crimp type
R161 331 400	Straight BH jack	Crimp type

QN Series

P/N	Interface	Model
R164 080 030	Straight plug	Crimp type

7/16 Series

P/N	Interface	Model
R185 077 010	Straight plug	Crimp type

⁽¹⁾ BCCAL = Copper Clad Aluminum

⁽²⁾ PE = PolyEthylene

CONSTRUCTION / DIMENSIONS

	Material	mm	Inches
Center conductor	Solid BCCAL (1)	4.47	0.176
Dielectric	Foam PE(2)	11.56	0.455
Inner shield	Aluminum Tape	11.71	0.461
Outer shield	Tinned Copper braid	12.45	0.49
Outer jacket	Black LSZH	14.99	0.59

ELECTRICAL CHARACTERISTICS

Characteristic impedance	50 ohms	
Operating frequency range	DC - 6 GHz	
Dielectric constant	1.32	
Screening effectiveness	> 90 dB	
Velocity of propagation	87 %	
Capacitance	76.6 pF / m	23.4 pF / ft
Inductance	0.19 uH / m	0.058 uH / ft
Time delay	3.83 nS / m	1.17 nS / ft
Inner conductor DC resistance	1.7 ohms / km	0.53 ohms / 1000 ft
Outer conductor DC resistance	3.9 ohms / km	1.2 ohms / 1000 ft
Voltage withstand	4000 Volts DC	
Jacket spark	8000 Volts RMS	
Peak power	40kW	
Phase stability over temp	< 25 ppm / deg C	

MECHANICAL CHARACTERISTICS

Maximum weight	0.20 kg / m	0.131 lb / ft
Min. bend radius: installation	38.1 mm	1.50 inch
Min. bend radius: repeated	152.4 mm	6.0 inch
Bending moment	3.73 N-m	2.75 ft-lb
Tensile strength	158.9 kg	350 lb
Flat plate crush	1.07 kg / mm	60 lb / inch

ENVIRONMENTAL CHARACTERISTICS

Installation temperature range	-40 / +85 °C	-40 / +185 °F
Storage temperature range	-70 / +85 °C	-94 / +185 °F
Operating temperature range	-40 / +85 °C	-40 / +185 °F

**FREQUENCY / ATTENUATION (typ.) /
AVG POWER (*)**

MHz	DB / 100 m	DB / 100 ft	kW
30	1.4	0.4	5.51
50	1.8	0.5	4.24
150	3.2	1.0	2.41
220	3.9	1.2	1.97
450	5.6	1.7	1.35
900	8.2	2.5	0.93
1500	10.9	3.3	0.70
1800	12.1	3.7	0.63
2000	12.8	3.9	0.59
2500	14.5	4.4	0.52
5800	23.8	7.3	0.32

^(*) = Avg power calculated at sea level / 40°C and VSWR 1:0

(Cable-assembly power ratings may be limited by the connector type. Please contact us for specific needs)

Connectors

The unique design of SHF cables allows for the use of custom-designed connectors. At Radiall, we pay particular attention to the design and to termination techniques to ensure low VSWR and superior cable performance.

Our cable /connector terminations are designed to maintain shield integrity into the lowest leakage attainable in a flexible assembly. All electrical connections (center contact and inner tape shield) are soldered.

Most popular connector interfaces to fit SHF cable are SMPM, SMP, SSMA, SMA, QRE, TNC, and N Type.

SHF cable range

Ultra low loss flexible cable



Cable	VP	Max Dia.	Attenuation	Bending radius	Weight
SHF2.4M	76%	2.45mm	4.59 dB/m @ 40GHz	10mm	20 g/m
DC-40GHz		0.095in	139 dB/100ft	0.394in	6.1 g/ft
SHF2.9M ⁽²⁾	75%	2.90mm	5.92 dB/m @ 67GHz	25mm	23 g/m
DC-67GHz		0.114in	179 dB/100ft	0.984in	7.01 g/ft
SHF3M	76%	3.64mm	2.76 dB/m @ 40GHz	12.5mm	35 g/m
DC-40GHz		0.139in	84 dB/100ft	0.492in	10.6 g/ft
SHF4M ⁽²⁾	84%	4.15mm	2.05 dB/m @ 40GHz	20mm	40 g/m
DC-40GHz		0.160in	62 dB/100ft	0.788in	12.2 g/ft
SHF4.2M	76%	4.20mm	1.96 dB/m @ 26.5GHz	25mm	45 g/m
DC-26.5GHz		0.165in	60 dB/100ft	0.984in	13.6 g/ft
SHF4.6M	84%	4.65mm	1.69 dB/m @ 32GHz	25mm	41 g/m
DC-32GHz		0.183in	51 dB/100ft	0.984in	12.5 g/ft
SHF5M	84%	5.20mm	1.27 dB/m @ 26.5GHz	25mm	60 g/m
DC-26.5GHz		0.201in	39 dB/100ft	0.984	18.2 g/ft
SHF8M	84%	7.78mm	0.68 dB/m @ 18GHz	40mm	130 g/m
DC-18GHz		0.302in	21 dB/100ft	1.575in	39.4 g/ft
SHF13	85%	13.80mm	0.33 dB/m @ 9.5GHz	60mm	280 g/m
DC-9.5GHz		0.543in	9 dB/100ft	2.362in	84.8 g/ft

⁽²⁾ Triple shield structure

⁽¹⁾ SPC: Silver Plated Copper

SHF cable range

Stranded Inner Conductor Cable



Using stranded center conductor allow better flexibility while keeping good IL performance level.

Longer flex life
SHF3, SHF5, SHF8

Ultra Flexible Cable



Unique design of center conductor as well as braiding and jacketing provide a unique flexibility behavior to SHF UF.

Low bending moment
Up to 1 million flexures
SHF2.2UF, SHF3UF, SHF5UF

Heavy Duty Protective Jacket



Projack provides the highest mechanical protection to SHF cables. Despite this high protection level, Projack maintains the same level of flexibility as the original cable.

Crush resistant 2500N/10cm
UV resistant
Watertightness

A/10 Armored Cable



In many customer applications, mechanical stress may damage cable assemblies. Radiall has designed several levels of armored structures embedding SHF core lines.

Crush resistant
1000N/10cm
Abrasion resistant
SHF5MA/10, SHF8MA/10

OD Outdoor Cable



Designed for outdoor environments, Radiall's outdoor cables are typically used for Ground Radars and Navy systems.

UV resistant
Watertightness
SHF5OD, SHF5MOD
SHF8OD, SHF8MOD

LW-2 Light Weight Cable



Radiall's Lightweight range is the best choice for on-board equipment, where weight and density are critical.

30% weight saving
SHF5MLW-2, SHF8MLW-2

AF-2 Air Frame Cable



SHF AirFrame cables: Robustness for extended life in extreme condition. Radiall's AirFrame cables are used in non-pressurized or not-protected areas.

Hermetically sealed
15 Km (50,000 ft) - 150°C
Fluid resistant
SHF5MAF-2, SHF8MAF-2

Ultra low loss SHF cable range

Attenuation (dB/m)

GHz	SHF2.4M	SHF2.9M	SHF3M	SHF4M	SHF4.2M	SHF4.6M	SHF5M	SHF8M	SHF13
1.0	0.62	0.62	0.40	0.30	0.38	0.25	0.23	0.15	0.09
2.0	0.89	0.88	0.58	0.43	0.54	0.36	0.32	0.21	0.14
4.0	1.28	1.26	0.84	0.61	0.79	0.52	0.46	0.30	0.20
6.0	1.59	1.56	1.05	0.76	0.99	0.65	0.57	0.37	0.26
8.0	1.86	1.82	1.23	0.88	1.16	0.76	0.66	0.44	0.30
12.4	2.36	2.30	1.59	1.10	1.50	0.98	0.84	0.55	-
18.0	2.91	2.82	1.97	1.35	1.87	1.21	1.02	0.68	-
26.5	3.62	3.49	2.49	1.66	2.36	1.51	1.27	-	-
32.0	4.03	3.87	2.79	1.83	-	1.69	-	-	-
40.0	4.59	4.39	3.20	2.07	-	-	-	-	-
50.0	-	4.99	-	-	-	-	-	-	-
67.0	-	5.92	-	-	-	-	-	-	-

Attenuation (dB/100 ft)

GHz	SHF2.4M	SHF2.9M	SHF3M	SHF4M	SHF4.2M	SHF4.6M	SHF5M	SHF8M	SHF13
1.0	18.90	18.90	12.19	9.14	11.58	7.62	7.01	4.57	2.74
2.0	27.13	26.82	17.68	13.11	16.46	10.97	9.75	6.40	4.27
4.0	39.01	38.40	25.60	18.59	24.08	15.85	14.02	9.14	6.10
6.0	48.46	47.55	32.00	23.16	30.18	19.81	17.37	11.28	7.92
8.0	56.69	55.47	37.49	26.82	35.36	23.16	20.12	13.41	9.14
12.4	71.93	70.10	48.46	33.53	45.72	29.87	25.60	16.76	-
18.0	88.70	85.95	60.05	41.15	57.00	36.88	31.09	-	-
26.5	110.34	106.38	75.90	50.60	71.93	46.02	38.71	-	-
32.0	122.83	117.96	85.04	55.78	-	51.51	-	-	-
40.0	139.90	133.81	97.54	63.09	-	-	-	-	-
50.0	-	152.10	-	-	-	-	-	-	-
67.0	-	180.44	-	-	-	-	-	-	-

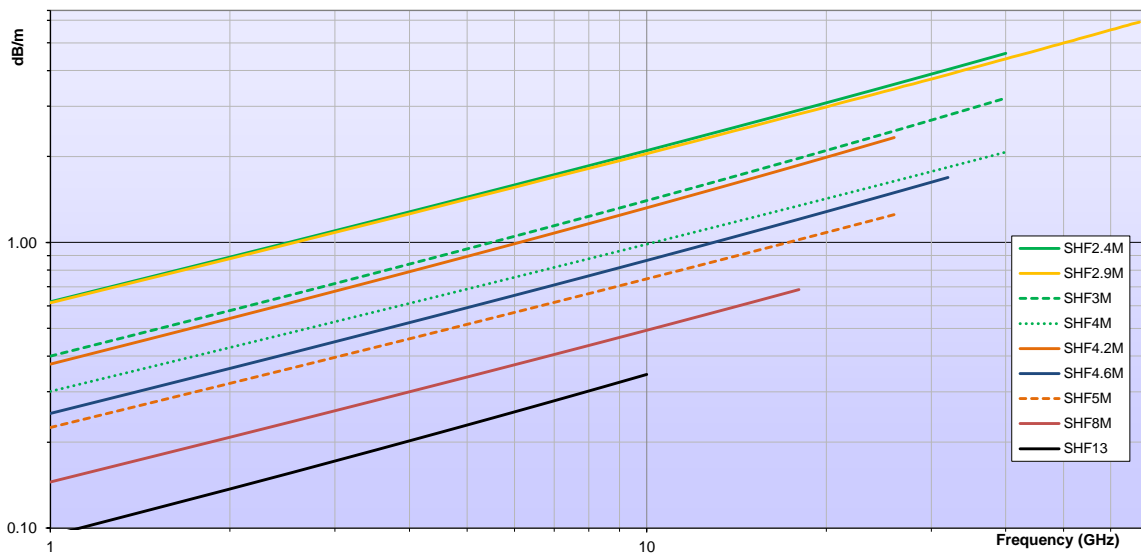

Ultra low loss SHF cable range

Power (W)

GHz	SHF2.4M	SHF2.9M	SHF3M	SHF4M	SHF4.2M	SHF4.6M	SHF5M	SHF8M	SHF13
1.0	260	260	400	475	630	422	850	1600	2500
2.0	184	184	283	336	445	298	601	1131	1768
4.0	130	130	200	238	315	211	425	800	1250
6.0	106	106	163	194	257	172	347	653	1021
8.0	92	92	141	168	223	149	301	566	884
12.4	74	74	114	135	179	120	241	454	-
18.0	61	61	94	112	148	99	200	377	-
26.5	51	51	78	92	122	82	165	-	-
32.0	46	46	71	84	-	75	-	-	-
40.0	41	41	63	75	-	-	-	-	-
50.0	-	37	-	-	-	-	-	-	-
67.0	-	32	-	-	-	-	-	-	-

(*) CW max power calculated at sea level / 40°C and V.S.W.R. 1:1
Cable assembly power rating may be limited by connector type

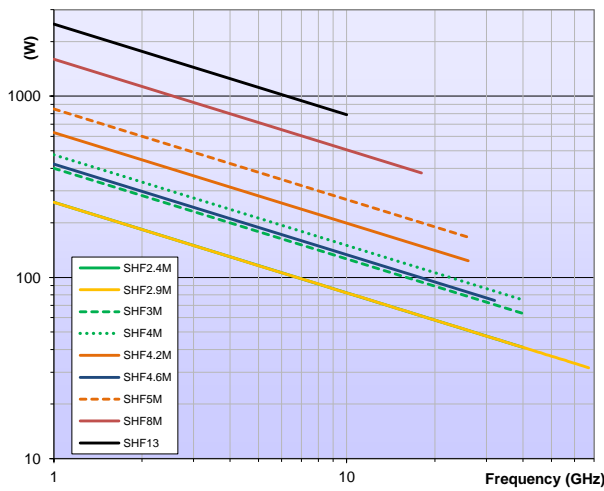

Phase change vs temperature

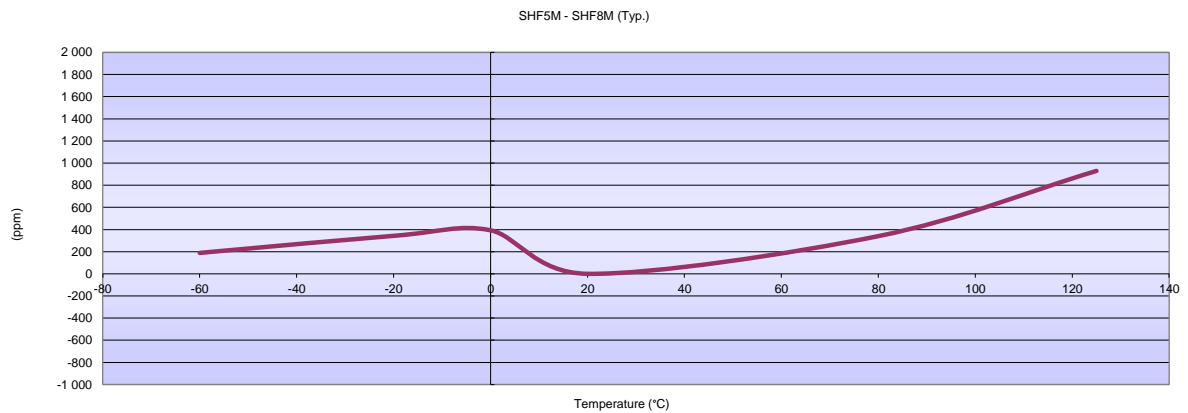



Microwave Components
R404 / R41



Contents

TERMINATIONS

Introduction..... 19-4
Low power terminations, up to 3 watts 19-5 to 19-7
Medium power terminations, up to 30 watts 19-7 to 19-8
High power terminations, up to 1000 watts 19-8 to 19-9
Platinum terminations, up to 1 Watt 19-10

ATTENUATORS

Introduction..... 19-10
Low power attenuators, up to 2 watts 19-11 to 19-13
Medium power attenuators, up to 30 watts 19-14
High power attenuators, up to 100 watts 19-5 to 19-16
Platinum attenuators, up to 2 Watts 19-17

COUPLERS & SPECIAL DEVICES

Introduction..... 19-17
Couplers 19-18 to 19-19
Special devices 19-20 to 19-21

INDEX 19-22



Introduction

Radiall coaxial terminations offer excellent reliability and repeatability from DC to 50 GHz. The offer includes low, medium, high power terminations, and a platinum range for instrumentation applications which provide the lowest VSWR.

Here are the main features of Radiall's terminations:

- Power range from 0.5W to 1000W
- Frequency from DC up to 50 GHz
- 50Ω Impedance
- High repeatability
- Compatibility with all standard connector interfaces
- Connector interface according to applicable MIL, DIN, NF and CEI
- Dedicated Platinum range for Test & Measurement providing lowest VSWR

LOW POWER TERMINATIONS



Power	0.5 to 3 Watts
Connectors	BMA, BNC, QMA, QN, N, SMA, SMA2.9, SMB, SMP, SSMA, TNC, 1.0/2.3
Frequency range	DC to 50 GHz

MEDIUM POWER TERMINATIONS



Power	6 to 30 Watts
Connectors	BNC, N, SMA, TNC, 7/16
Frequency range	DC to 18 GHz

HIGH POWER TERMINATIONS



Power	50 to 1000 Watts
Connectors	N, SMA, TNC, 7/16
Frequency range	DC to 6 GHz

PLATINUM TERMINATIONS

Radiall's low power terminations offer is dedicated for Test & Measurement and provides the lowest VSWR.



Power	1 Watt
Connectors	SMA2.9, SMA3.5, SMA, N, BNC, TNC
Frequency	DC to 40 GHz



Our Most Important Connection is with You.™

TERMINATIONS

Low power terminations, up to 3 watts

1.0/2.3 - 50 OHMS

Frequency DC to (GHz)	VSWR max.	Return loss min. (dB)	Power rating (W)		Impedance (Ω)	Gender	Part Number
			Avg. (W)	Peak (W)			
2.5	1.15	23.1	1	100	50±5%	male	R404 144 000

7/16 - 50 OHMS

Frequency DC to (GHz)	VSWR max.	Return loss min. (dB)	Power rating (W)		Impedance (Ω)	Gender	Part Number
			Avg. (W)	Peak (W)			
4	1.15	23.1	2	500	50±5%	male	R404 170 111
4	1.15	23.1	2	500	50±5%	female	R404 175 111

BMA - 50 OHMS

Frequency DC to (GHz)	VSWR max.	Return loss min. (dB)	Power rating (W)		Impedance (Ω)	Gender	Part Number
			Avg. (W)	Peak (W)			
18	1.2	20.8	1	100	50±5%	male	R404 270 000
18	1.3	17.7	1	100	50±5%	female	R404 275 000

BNC - 50 AND 75 OHMS

Frequency DC to (GHz)	VSWR max.	Return loss min. (dB)	Power rating (W)		Impedance (Ω)	Gender	Part Number
			Avg. (W)	Peak (W)			
1	-	-	1	500	50±1%	male	R404 441 000 ⁽³⁾
1	-	-	1	500	50±1%	male	R404 441 120 ^{(1) (3)}
1	-	-	1	500	50±1%	male	R404 441 121 ^{(2) (3)}
4	1.2	20.8	1	100	50±2%	male	R404 111 000
4	1.2	20.8	1	100	50±2%	male	R404 111 120 ⁽¹⁾
4	1.2	20.8	1	100	50±2%	female	R404 112 000
8	1.25	19.1	1	1,000	50±5%	male	R404 110 000
8	1.25	19.1	1	1,000	50±5%	male	R404 110 120 ⁽¹⁾
1	1.15	23.1	1	500	75±5%	male	R404 012 000
1	1.15	23.1	1	500	75±5%	male	R404 012 120
1	1.15	23.1	1	500	75±5%	female	R404 014 000
1	-	-	1	500	75±0.1%	male	R404 4120 00 ⁽³⁾
1	-	-	1	500	75±1%	male	R404 442 000 ⁽³⁾
1	-	-	1	500	75±1%	male	R404 442 120 ^{(1) (3)}

(1) with bead chain, (2) with cord, (3) resistive pad

N - 50 OHMS

Frequency DC to (GHz)	VSWR max.	Return loss min. (dB)	Power rating (W)		Impedance (Ω)	Gender	Part Number
			Avg. (W)	Peak (W)			
4	1.2	20.8	1	500	50±2%	male	R404 131 000
4	1.2	20.8	1	500	50±2%	male	R404 131 120 ⁽¹⁾
4	1.2	20.8	1	500	50±2%	female	R404 132 000
12.4	1.15	23.1	1	500	50±2%	male	R404 240 000
12.4	1.15	23.1	1	500	50±2%	male	R404 240 120 ⁽¹⁾
12.4	1.15	23.1	1	500	50±2%	male	R404 240 121 ⁽²⁾
12.4	1.15	23.1	1	500	50±2%	female	R404 245 000
18	1.2	20.8	2	100	50±2%	male	R404 340 000
18	1.2	20.8	2	100	50±2%	male	R404 340 120 ⁽¹⁾
18	1.2	20.8	2	100	50±2%	female	R404 355 000

(1) with bead chain, (2) with cord

QMA - 50 OHMS

Frequency DC to (GHz)	VSWR max.	Return loss min. (dB)	Power rating (W)		Impedance (Ω)	Gender	Part Number
			Avg. (W)	Peak (W)			
3	1.1	26.4	2	200	50±5%	male	R404 114 111
4	1.2	20.8	1	100	50±5%	male	R404 114 000
4	1.2	20.8	1	100	50±5%	male	R404 114 120 ⁽¹⁾

(1) with bead chain



Low power terminations, up to 3 watts

QN - 50 OHMS

Frequency DC to (GHz)	VSWR max.	Return loss min. (dB)	Power rating (W)		Impedance (Ω)	Gender	Part Number
			Avg. (W)	Peak (W)			
4	1.2	20.8	1	100	50±5%	male	R404 116 000

SMA - 50 OHMS

Frequency DC to (GHz)	VSWR max.	Return loss min. (dB)	Power rating (W)		Impedance (Ω)	Gender	Part Number
			Avg. (W)	Peak (W)			
4	1.2	20.8	1	100	50±5%	male	R404 101 000
4	1.2	20.8	1	100		male	R404 101 120 ⁽¹⁾
4	1.25	19.1	1	100		female	R404 102 000
8	1.15	23.1	3	250		male	R404 600 000
18	1.2	20.8	1	100		male	R404 N05 000
18	1.2	20.8	1	100		male	R404 N05 120 ⁽¹⁾
18	1.2	20.8	1	100		male	R404 N05 121 ⁽²⁾
18	1.2	20.8	1	100		female	R404 N06 000
18	1.2	20.8	2	100		male	R404 N01 000
18	1.2	20.8	2	100		male	R404 N01 120 ⁽¹⁾
18	1.2	20.8	2	100		male	R404 N01 121 ⁽²⁾
18	1.2	20.8	2	100		female	R404 N02 000
18	1.34	16.8	3	250		male	R404 605 000
26.5	1.3	17.7	1	100		male	R404 N07 000
26.5	1.3	17.7	1	100		female	R404 N08 000
26.5	1.3	17.7	2	100		male	R404 N03 000
26.5	1.3	17.7	2	100		female	R404 N04 000
18	1.15		1	100		male	9620-9003-151
18	1.15		1	100		male	9620-9003-251

(1) with bead chain, (2) with cord

SMA2.9 - 50 OHMS

Frequency DC to (GHz)	VSWR max.	Return loss min. (dB)	Power rating (W)		Impedance (Ω)	Gender	Part Number
			Avg. (W)	Peak (W)			
40	1.35	16.5	1	100	50±5%	male	R404 280 000
40	1.35	16.5	1	100	50±5%	female	R404 285 000

SMB - 50 OHMS

Frequency DC to (GHz)	VSWR max.	Return loss min. (dB)	Power rating (W)		Impedance (Ω)	Gender	Part Number
			Avg. (W)	Peak (W)			
4	1.2	20.8	1	100	50±5%	male	R404 104 000
4	1.2	20.8	1	100	50±5%	female	R404 105 000
8	1.25	19.1	0.5	100	50±5%	female	R404 155 000 ⁽²⁾
8	1.25	19.1	0.5	100	50±5%	female	R404 165 000

(2) with cord

SMC - 50 OHMS

Frequency DC to (GHz)	VSWR max.	Return loss min. (dB)	Power rating (W)		Impedance (Ω)	Gender	Part Number
			Avg. (W)	Peak (W)			
8	1.25	19.1	0.5	100	50±5%	female	R404 160 000 1036-1511-051



Our Most Important Connection is with You.™

Low power terminations, up to 3 watts

SMP - 50 OHMS

Frequency DC to (GHz)	VSWR max.	Return loss min. (dB)	Power rating (W)		Impedance (Ω)	Gender	Part Number
			Avg. (W)	Peak (W)			
18	1.3	17.7	1	100	50±5%	male	R404 N61 000
18	1.3	17.7	1	100	50±5%	female	R404 N62 000
40	1.7	11.7	0.5	100	50±5%	male	R404 260 000
40	1.7	11.7	0.5	100	50±5%	female	R404 262 000

SSMA - 50 OHMS

Frequency DC to (GHz)	VSWR max.	Return loss min. (dB)	Power rating (W)		Impedance (Ω)	Gender	Part Number
			Avg. (W)	Peak (W)			
18	1.35	16.5	0.5	100	50±5%	male	R404 380 000

TNC - 50 OHMS

Frequency DC to (GHz)	VSWR max.	Return loss min. (dB)	Power rating (W)		Impedance (Ω)	Gender	Part Number
			Avg. (W)	Peak (W)			
4	1.2	20.8	1	100	50±2%	male	R404 121 000
4	1.2	20.8	1	100	50±2%	male	R404 121 120 ⁽¹⁾
4	1.2	20.8	1	100	50±2%	female	R404 122 000
12.4	1.25	19.1	1	500	50±5%	male	R404 225 000
12.4	1.25	19.1	1	500	50±5%	male	R404 225 120 ⁽¹⁾
18	1.2	20.8	2	100	50±5%	male	R404 370 000
18	1.2	20.8	2	100	50±5%	male	R404 370 120 ⁽¹⁾
18	1.2	20.8	2	100	50±5%	female	R404 375 000

(1) with bead chain

4.3/10 - 50 OHMS

Frequency DC to (GHz)	VSWR max.	Return loss min. (dB)	Power rating (W)		Impedance (Ω)	Gender	Part Number
			Avg. (W)	Peak (W)			
6	1.25	19.1	2	500	50±5%	male screw	R4041D1000
6	1.25	19.1	2	500	50±5%	male screw	R4041D1121 ⁽²⁾
6	1.25	19.1	2	500	50±5%	male push-pull	R4041D2000
6	1.25	19.1	2	500	50±5%	male push-pull	R4041D2121 ⁽²⁾
6	1.25	19.1	2	500	50±5%	female	R4041D5000

(2) with cord

Medium power terminations, up to 30 watts

7/16 - 50 OHMS

Frequency DC to (GHz)	VSWR max.	Return loss min. (dB)	Power rating (W)		Impedance (Ω)	Gender	Part Number
			Avg. (W)	Peak (W)			
6	1.3	17.7	30	2,000	50±5%	male	R404 756 000
4	1.2	20.8	12	4,000	50±5%	male	R404 564 000

BNC - 50 OHMS

Frequency DC to (GHz)	VSWR max.	Return loss min. (dB)	Power rating (W)		Impedance (Ω)	Gender	Part Number
			Avg. (W)	Peak (W)			
2	1.1	26.4	6	4,000	50±5%	male	R404 505 000
2	1.1	26.4	12	4,000	50±5%	male	R404 555 000
8	1.25	19.1	6	4,000	50±5%	male	R404 510 000
8	1.25	19.1	12	4,000	50±5%	male	R404 560 000



Medium power terminations, up to 30 watts

N - 50 OHMS

Frequency DC to (GHz)	VSWR max.	Return loss min. (dB)	Power rating (W)		Impedance (Ω)	Gender	Part Number
			Avg. (W)	Peak (W)			
2	1.1	26.4	6	4,000	50±5%	male	R404 507 000
2	1.1	26.4	12	4,000	50±5%	male	R404 557 000
6	1.3	17.7	30	2,000	50±5%	male	R404 750 000
6	1.3	17.7	30	2,000	50±5%	female	R404 751 000
12.4	1.3	17.7	6	4,000	50±5%	male	R404 517 000
12.4	1.3	17.7	12	4,000	50±5%	male	R404 567 000
12.4	1.25	19.1	20	300	50±5%	male	R404 587 000
12.4	1.25	19.1	20	300	50±5%	female	R404 587 500
18	1.3	17.7	6	300	50±5%	male	R404 522 000
18	1.3	17.7	12	300	50±5%	male	R404 572 000
18	1.35	16.5	20	300	50±5%	male	R404 588 000
18	1.35	16.5	20	300	50±5%	female	R404 588 500

TNC - 50 OHMS

Frequency DC to (GHz)	VSWR max.	Return loss min. (dB)	Power rating (W)		Impedance (Ω)	Gender	Part Number
			Avg. (W)	Peak (W)			
2	1.1	26.4	6	4,000	50±5%	male	R404 506 000
2	1.1	26.4	12	4,000	50±5%	male	R404 556 000
6	1.3	17.7	30	2,000	50±5%	male	R404 752 000
6	1.3	17.7	30	2,000	50±5%	female	R404 753 000
12.4	1.3	17.7	6	4,000	50±5%	male	R404 516 000
12.4	1.3	17.7	12	4,000	50±5%	male	R404 566 000
12.4	1.25	19.1	20	300	50±5%	male	R404 585 000
12.4	1.25	19.1	20	300	50±5%	female	R404 585 500
18	1.3	17.7	12	300	50±5%	male	R404 571 000
18	1.35	16.5	20	300	50±5%	male	R404 586 000
18	1.35	16.5	20	300	50±5%	male	R404 586 500

4.3/10 - 50 OHMS

Frequency DC to (GHz)	VSWR max.	Return loss min. (dB)	Power rating (W)		Impedance (Ω)	Gender	Part Number
			Avg. (W)	Peak (W)			
6	1.3	17.7	30	2,000	50±5%	male screw	R404 758 000
6	1.3	17.7	30	2,000	50±5%	female	R404 759 000

High power terminations, up to 1000 watts

7/16 - 50 OHMS

Frequency DC to (GHz)	VSWR max.	Return loss min. (dB)	Power rating (W)		Impedance (Ω)	Gender	Part Number	Weight (g)
			Avg. (W)	Peak (W)				
1	1.1	26.4	1000	40,000	50±5%	female	R404 867 000	15,000
2.5	1.3	17.7	600	40,000	50±5%	female	R404 865 000	8,200
6	1.3	17.7	50	200	50±5%	male	R404 766 000	260
6	1.3	17.7	50	200	50±5%	female	R404 767 000	250
6	1.3	17.7	100	200	50±5%	male	R404 776 000	1,300
6	1.3	17.7	100	200	50±5%	female	R404 777 000	1,300
6	1.3	17.7	150	2,000	50±5%	male	R404 786 000	1,500
6	1.3	17.7	150	2,000	50±5%	female	R404 787 000	1,500
6	1.3	17.7	200	2,000	50±5%	male	R404 786 020	2,000
6	1.3	17.7	200	2,000	50±5%	female	R404 787 020	2,000

7/16 - 50 OHMS CONDUCTION COOLING

Frequency DC to (GHz)	VSWR max.	Return loss min. (dB)	Power rating (W)		Impedance (Ω)	Gender	Part Number	Weight (g)
			Avg. (W)	Peak (W)				
6	1.3	17.7	200	2,000	50±5%	male	R404 786 120	140
6	1.3	17.7	200	2,000	50±5%	female	R404 787 120	140



Our Most Important Connection is with You.™

High power terminations, up to 1000 watts

N - 50 OHMS

Frequency DC to (GHz)	VSWR max.	Return loss min. (dB)	Power rating (W)		Impedance (Ω)	Gender	Part Number	Weight (g)
			Avg. (W)	Peak (W)				
2.5	1.3	17.7	400	40,000	50±5%	female	R404 863 000	4,200
6	1.3	17.7	50	2,000	50±5%	male	R404 760 000	210
6	1.3	17.7	50	2,000	50±5%	female	R404 761 000	200
6	1.3	17.7	100	2,000	50±5%	male	R404 770 000	1,200
6	1.3	17.7	100	2,000	50±5%	female	R404771000	1,200
6	1.3	17.7	150	2,000	50±5%	male	R404780000	1,500
6	1.3	17.7	150	2,000	50±5%	female	R404781000	1,500
6	1.3	17.7	200	2,000	50±5%	male	R404780020	2,000
6	1.3	17.7	200	2,000	50±5%	female	R404781020	2,000
6	1.2	20.8	250		50±5%	female	R404861000	3,000

N - 50 OHMS CONDUCTION COOLING

Frequency DC to (GHz)	VSWR max.	Return loss min. (dB)	Power rating (W)		Impedance (Ω)	Gender	Part Number	Weight (g)
			Avg. (W)	Peak (W)				
6	1.3	17.7	200	2,000	50±5%	male	R404 780 120	140
6	1.3	17.7	200	2,000	50±5%	female	R404 781 120	140

SMA - 50 OHMS

Frequency DC to (GHz)	VSWR max.	Return loss min. (dB)	Power rating (W)		Impedance (Ω)	Gender	Part Number	Weight (g)
			Avg. (W)	Peak (W)				
6	1.3	17.7	50	200	50±5%	male	R404 764 000	200
6	1.3	17.7	50	200	50±5%	female	R404 765 000	200
6	1.3	17.7	100	200	50±5%	male	R404 774 000	1,200
6	1.3	17.7	100	200	50±5%	female	R404 775 000	1,200

TNC - 50 OHMS

Frequency DC to (GHz)	VSWR max.	Return loss min. (dB)	Power rating (W)		Impedance (Ω)	Gender	Part Number	Weight (g)
			Avg. (W)	Peak (W)				
6	1.3	17.7	50	200	50±5%	male	R404 762 000	200
6	1.3	17.7	50	200	50±5%	female	R404 763 000	200
6	1.3	17.7	100	200	50±5%	male	R404 772 000	1,200
6	1.3	17.7	100	200	50±5%	female	R404 773 000	1,200
6	1.3	17.7	150	2,000	50±5%	male	R404 782 000	1,500
6	1.3	17.7	150	2,000	50±5%	female	R404 783 000	1,500
6	1.3	17.7	200	2,000	50±5%	male	R404 782 020	1,900
6	1.3	17.7	200	2,000	50±5%	female	R404 783 020	1,900

TNC - 50 OHMS CONDUCTION COOLING

Frequency DC to (GHz)	VSWR max.	Return loss min. (dB)	Power rating (W)		Impedance (Ω)	Gender	Part Number	Weight (g)
			Avg. (W)	Peak (W)				
6	1.3	17.7	200	2,000	50±5%	male	R404 782 120	140
6	1.3	17.7	200	2,000	50±5%	female	R404 783 120	140

4.3/10 - 50 OHMS

Frequency DC to (GHz)	VSWR max.	Return loss min. (dB)	Power rating (W)		Impedance (Ω)	Gender	Part Number	Weight (g)
			Avg. (W)	Peak (W)				
6	1.3	17.7	50	200	50±5%	male screw	R404 768 000	200
6	1.3	17.7	50	200	50±5%	female	R404 769 000	200
6	1.3	17.7	100	200	50±5%	male screw	R404 778 000	1,200
6	1.3	17.7	100	200	50±5%	female	R404 779 000	1,200



Platinum terminations, up to 1 watt

Radiall's platinum series of terminations is designed for test & measurement applications. This range can be easily integrated in communication matrices, test benches and laboratories where high RF performance and reliability are essential.

Here are the main features of Radiall's platinum series of terminations:

- 1 W power rating
- Frequency from DC up to 40 GHz
- Lowest VSWR
- 50Ω Impedance
- Compatibility with all standards Test & Measurement interfaces
- Full integration in Radiall Test & Measurement offer:
Electro-mechanical switches & Testpro cable Assemblies



SMA 2.9 - 50 OHMS

Frequency DC to (GHz)	VSWR max.	Return loss min. (dB)	Power rating (W)		Impedance (Ω)	Gender	Part Number
			Avg. (W)	Peak (W)			
40	1.18	21.7	1	50	50±5%	male	R404 280 150
40	1.22	20.1	1	50	50±5%	female	R404 285 150

SMA 3.5 - 50 OHMS

Frequency DC to (GHz)	VSWR max.	Return loss min. (dB)	Power rating (W)		Impedance (Ω)	Gender	Part Number
			Avg. (W)	Peak (W)			
26.5	1.1	26.4	1	50	50±5%	male	R404 211 150
26.5	1.12	24.9	1	50	50±5%	female	R404 216 150

SMA - 50 Ohms

Frequency DC to (GHz)	VSWR max.	Return loss min. (dB)	Power rating (W)		Impedance (Ω)	Gender	Part Number
			Avg. (W)	Peak (W)			
18	1.1	26.4	1	50	50±5%	male	R404 210 150
18	1.1	24.9	1	50	50±5%	female	R404 215 150

N - 50 Ohms

Frequency DC to (GHz)	VSWR max.	Return loss min. (dB)	Power rating (W)		Impedance (Ω)	Gender	Part Number
			Avg. (W)	Peak (W)			
18	1.1	26.4	1	50	50±5%	male	R404 350 150
18	1.1	24.9	1	50	50±5%	female	R404 355 150

TNC - 50 OHMS

Frequency DC to (GHz)	VSWR max.	Return loss min. (dB)	Power rating (W)		Impedance (Ω)	Gender	Part Number
			Avg. (W)	Peak (W)			
12.4	1.15	23.1	1	50	50±5%	male	R404 370 150
12.4	1.15	23.1	1	50	50±5%	female	R404 375 150

BNC - 50 OHMS

Frequency DC to (GHz)	VSWR max.	Return loss min. (dB)	Power rating (W)		Impedance (Ω)	Gender	Part Number
			Avg. (W)	Peak (W)			
12.4	1.12	24.9	1	50	50±5%	male	R404 110 150
12.4	1.12	24.9	1	50	50±5%	female	R404 115 150



Introduction

Radiall coaxial fixed attenuators offer excellent reliability and repeatability from DC to 40 GHz. The offer includes low, medium, high power attenuators and a platinum range for instrumentation applications which provide the lowest VSWR.

Here are the main features of Radiall's attenuators:

- Power range from 0.5W to 100W
- Frequency from DC up to 40 GHz
- Attenuation values from 0 up to 60 dB
- High repeatability
- 50Ω Impedance
- Compatibility with all standard connectors interfaces: BNC, QN, N, 7/16, SMA, TNC, SMA2.9
- Dedicated Platinum range for Test & Measurement providing lowest VSWR

LOW POWER ATTENUATORS



Power	0.5 to 2 Watts
Connectors	BNC, QN, N, SMA, SMA2.9, SMB, TNC, 7/16
Frequency range	DC to 40 GHz
Attenuation range	0 to 60 dB

MEDIUM POWER ATTENUATORS



Power	3 to 50 Watts
Connectors	BNC, N, SMA, TNC, 7/16
Frequency range	DC to 18 GHz
Attenuation range	0 to 30 dB

HIGH POWER ATTENUATORS



Power	80 to 100 Watts
Connectors	N, SMA, TNC, 7/16
Frequency range	DC to 6 GHz
Attenuation range	0 to 20 dB

PLATINUM ATTENUATORS

Radiall's low power attenuator offer is dedicated for Test & Measurement and provides the lowest VSWR.



Power	2 Watts
Connectors	SMA2.9, SMA3.5, SMA, N, BNC, TNC
Frequency range	DC to 40 GHz
Attenuation range	0 to 30 dB



Low power attenuators, up to 2 watts

7/16 - 50 OHMS, MALE TO FEMALE

Frequency DC to (GHz)	VSWR max.	Return loss min. (dB)	Power rating (W)		Nom. Attenuation (dB)	Max dev.	Part Number
			Avg. (W)	Peak (W)			
3	1.3	17.7	1	100	xx	± 0.5 ⁽¹⁾	R412 8xx 000
Available attenuation value: xx = 03, 06, 10 and 20 dB							

⁽¹⁾ ± 1 for xx = 20

BNC - 50 OHMS, MALE TO FEMALE

Frequency DC to (GHz)	VSWR max.	Return loss min. (dB)	Power rating (W)		Nom. Attenuation (dB)	Max dev.	Part Number
			Avg. (W)	Peak (W)			
2	1.2	20.8	2	100	xx	± 0.35 ⁽¹⁾	R412 4xx 000
Available attenuation value: xx = 00 to 20 step 1, 30, 40 and 50 dB							
3	1.3	17.7	1	100	xx	± 0.5 ⁽²⁾	R412 4xx 124
Available attenuation value: xx = 00 to 20 step 1 dB							
8	1.25	19.1	2	100	xx	± 0.5 ⁽³⁾	R414 4xx 000
Available attenuation value: xx = 00 to 15 step 1, 20, 25, 30, 40 - 50 and 60 dB							

⁽¹⁾ up to xx = 14, ⁽²⁾ up to xx = 15, ⁽³⁾ up to xx = 25

N - 50 OHMS, MALE TO FEMALE

Frequency DC to (GHz)	VSWR max.	Return loss min. (dB)	Power rating (W)		Nom. Attenuation (dB)	Max dev.	Part Number
			Avg. (W)	Peak (W)			
2	1.15	23.1	2	100	xx	± 0.35 ⁽¹⁾	R412 7xx 000
Available attenuation value: xx = 00 to 15 step 1, 20, 30, 40 and 50 dB							
6	1.4	15.6	1	100	xx	± 0.5 ⁽¹⁾	R412 700 124
Available attenuation value: xx = 00 to 20 dB step 1							
12.4	1.4	15.6	2	100	xx	± 0.7 ⁽²⁾	R414 7xx 000
Available attenuation value: xx = 00 to 15 step 1, 20, 25, 30, 40 - 50 and 60 dB							
18	1.35	16.5	2	100	xx	± 0.4 ⁽³⁾	R414 7xx 161
Available attenuation value: xx = 00 to 20 dB step 1							

⁽¹⁾ up to xx = 15, ⁽²⁾ up to xx = 20, ⁽³⁾ up to xx = 6

QMA - 50 OHMS, MALE TO FEMALE

Frequency DC to (GHz)	VSWR max.	Return loss min. (dB)	Power rating (W)		Nom. Attenuation (dB)	Max dev.	Part Number
			Avg. (W)	Peak (W)			
6	1.3	17.7	1	100	xx	± 0.5 ⁽¹⁾	R411 7xx 124
Available attenuation value: xx = 00 to 20 dB step 1							

⁽¹⁾ up to xx = 15

QN - 50 OHMS, MALE TO FEMALE

Frequency DC to (GHz)	VSWR max.	Return loss min. (dB)	Power rating (W)		Nom. Attenuation (dB)	Max dev.	Part Number
			Avg. (W)	Peak (W)			
3	1.3	17.7	1	100	xx	± 0.5 ⁽¹⁾	R412 3xx 124
Available attenuation value: xx = 00 to 20 dB step 1							

⁽¹⁾ up to xx = 15

SMA - 50 OHMS, MALE TO FEMALE, .75IN.

Frequency DC to (GHz)	VSWR max.	Return loss min. (dB)	Power rating (W)		Nom. Attenuation (dB)	Max dev.	Part Number
			Avg. (W)	Peak (W)			
6	1.4	15.6	1	100	xx	± 0.5 ⁽¹⁾	R411 8xx 124
Available attenuation value: xx = 00 to 20 dB step 1							
12.4	1.3	17.7	2	100	xx	± 0.5 ⁽²⁾	R411 8xx 119
Available attenuation value: xx = 00 to 20 step 1 and 30 dB							
18	1.35	16.5	2	100	xx	± 0.7 ⁽³⁾	R411 8xx 121
Available attenuation value: xx = 00 to 20 step 1 and 30 dB							

⁽¹⁾ up to xx = 15, ⁽²⁾ up to xx = 10, ⁽³⁾ up to xx = 7



Low power attenuators, up to 2 watts

SMA - 50 OHMS, MALE TO FEMALE, .86IN.

Frequency DC to (GHz)	VSWR max.	Return loss min. (dB)	Power rating (W)		Nom. Attenuation (dB)	Max dev.	Part Number
			Avg. (W)	Peak (W)			
4	1.15	23.1	2	100	xx	± 0.3 ⁽¹⁾	R413 8xx 115
Available attenuation value: xx = 00 to 20 step 1, 30, 40 - 50 and 60 dB							
18	1.35	16.5	2	100	xx	± 0.3 ⁽¹⁾	R413 8xx 000
Available attenuation value: xx = 00 to 20 step 1, 25, 30, 35, 40, 45 - 50, 55 and 60 dB							
26.5	1.5	14.0	2	100	xx	± 0.5 ⁽¹⁾	R413 8xx 121
Available attenuation value: xx = 00 to 20 step 1, 25 and 30 dB							

⁽¹⁾ up to xx = 6

SMA 2.9 - 50 OHMS, MALE TO FEMALE

Frequency DC to (GHz)	VSWR max.	Return loss min. (dB)	Power rating (W)		Nom. Attenuation (dB)	Max dev.	Part Number
			Avg. (W)	Peak (W)			
40	1.6	12.7	2	100	xx	± 0.8	R413 3xx 000
Available attenuation value: xx = 00 to 10 step 1 and 20 dB							

SMB - 50 OHMS, MALE TO FEMALE

Frequency DC to (GHz)	VSWR max.	Return loss min. (dB)	Power rating (W)		Nom. Attenuation (dB)	Max dev.	Part Number
			Avg. (W)	Peak (W)			
8	1.3	17.7	2	100	xx	± 0.5	R410 2xx 121
Available attenuation value: xx = 03, 06, 10 and 20 dB							

SMC - 50 OHMS, MALE TO FEMALE

Frequency DC to (GHz)	VSWR max.	Return loss min. (dB)	Power rating (W)		Nom. Attenuation (dB)	Max dev.	Part Number
			Avg. (W)	Peak (W)			
8	1.3	17.7	2	100	xx	± 0.5	R410 1xx 121
Available attenuation value: xx = 03, 06, 10 and 20 dB							

TNC - 50 OHMS, MALE TO FEMALE

Frequency DC to (GHz)	VSWR max.	Return loss min. (dB)	Power rating (W)		Nom. Attenuation (dB)	Max dev.	Part Number
			Avg. (W)	Peak (W)			
2	1.15	23.1	2	100	xx	± 0.35 ⁽¹⁾	R412 5xx 000
Available attenuation value: xx = 00 to 15 step 1, 20, 30, 40 and 50 dB							
3	1.3	17.7	1	100	xx	± 0.5 ⁽²⁾	R412 5xx 124
Available attenuation value: xx = 00 to 20 dB step 1							
12.4	1.3	17.7	2	100	xx	± 0.7 ⁽³⁾	R414 5xx 000
Available attenuation value: xx = 00 to 15 step 1, 20, 25, 30, 40 - 50 and 60 dB							
18	1.35	16.5	2	100	xx	± 0.4 ⁽⁴⁾	R414 5xx 161
Available attenuation value: xx = 00 to 20 dB step 1							

⁽¹⁾ up to xx = 15, ⁽²⁾ up to xx = 14, ⁽³⁾ up to xx = 6



Medium power attenuators, up to 30 watts

7/16 - 50 OHMS, MALE TO FEMALE

Frequency DC to (GHz)	VSWR max.	Return loss min. (dB)	Power rating (W)		Nom. Attenuation (dB)	Max dev.	Part Number
			Avg. (W)	Peak (W)			
4	1.35	16.5	25	5,000	xx	± 0.6 ⁽¹⁾	R4203xx110
Available attenuation value: xx = 03, 06, 10 and 20 dB							

⁽¹⁾ ± 0.6 for xx = 20

BNC - 50 OHMS, MALE TO FEMALE

Frequency DC to (GHz)	VSWR max.	Return loss min. (dB)	Power rating (W)		Nom. Attenuation (dB)	Max dev.	Part Number
			Avg. (W)	Peak (W)			
4	1.3	17.7	15 ⁽²⁾	250	xx	± 0.5	R4154xx000
Available attenuation value: xx = 03, 06, 10 and 20 dB							

⁽²⁾ 12 for xx= 06 , 10 for xx = 10 and 20

N - 50 OHMS, MALE TO FEMALE

Frequency DC to (GHz)	VSWR max.	Return loss min. (dB)	Power rating (W)		Nom. Attenuation (dB)	Max dev.	Part Number
			Avg. (W)	Peak (W)			
4	1.35	16.5	25	5,000	xx	± 0.6 ⁽¹⁾	R417 3xx 110
Available attenuation value: xx = 03, 06, 10, 20 and 30 dB							
4	1.35	16.5	30	5,000	xx	± 0.6 ⁽¹⁾	R417 3xx 130
Available attenuation value: xx = 03, 06, 10, 20 and 30 dB							
8	1.25	19.1	15 ⁽²⁾	250	xx	± 0.3	R415 7xx 000
Available attenuation value: xx = 03, 06, 10 and 20 dB							
18	1.4	15.6	15 ⁽²⁾	300	xx	± 0.5	R416 0xx 000
Available attenuation value: xx = 03, 06, 10 and 20 dB							

⁽¹⁾ up to xx = 10

⁽²⁾ 12 for xx= 06 , 10 for xx = 10 and 20

SMA - 50 OHMS, MALE TO FEMALE

Frequency DC to (GHz)	VSWR max.	Return loss min. (dB)	Power rating (W)		Nom. Attenuation (dB)	Max dev.	Part Number
			Avg. (W)	Peak (W)			
4	1.35	16.5	25	5,000	xx	± 0.6 ⁽¹⁾	R417 5xx 110
Available attenuation value: xx = 03, 06, 10, 20 and 30 dB							
4	1.35	16.5	30	5,000	xx	± 0.6 ⁽¹⁾	R417 5xx 130
Available attenuation value: xx = 03, 06, 10, 20 and 30 dB							
8	1.25	19.1	15 ⁽²⁾	250	xx	± 0.3	R415 3xx 000
Available attenuation value: xx = 03, 06, 10 and 20 dB							
18	1.4	15.6	15 ⁽²⁾	300	xx	± 0.5	R416 1xx 000
Available attenuation value: xx = 03, 06, 10 and 20 dB							

⁽¹⁾ up to xx = 10

⁽²⁾ 12 for xx= 06 , 10 for xx = 10 and 20

TNC - 50 OHMS, MALE TO FEMALE

Frequency DC to (GHz)	VSWR max.	Return loss min. (dB)	Power rating (W)		Nom. Attenuation (dB)	Max dev.	Part Number
			Avg. (W)	Peak (W)			
4	1.35	16.5	25	5,000	xx	± 0.6 ⁽¹⁾	R417 6xx 110
Available attenuation value: xx = 03, 06, 10, 20 and 30 dB							
4	1.35	16.5	30	5,000	xx	± 0.6 ⁽¹⁾	R417 6xx 130
Available attenuation value: xx = 03, 06, 10, 20 and 30 dB							
8	1.25	19.1	15 ⁽²⁾	250	xx	± 0.3 ⁽¹⁾	R415 5xx 000
Available attenuation value: xx = 03, 06, 10 and 20 dB							
18	1.4	15.6	15 ⁽²⁾	300	xx	± 0.5	R416 8xx 000
Available attenuation value: xx = 03, 06, 10 and 20 dB							

⁽¹⁾ up to xx = 10

⁽²⁾ 12 for xx= 06 , 10 for xx = 10 and 20



High power attenuators, up to 100 watts

7/16 - 50 OHMS, MALE TO FEMALE

Frequency DC to (GHz)	VSWR max.	Return loss min. (dB)	Power rating (W)		Nom. Attenuation (dB)	Max dev.	Part Number
			Avg. (W)	Peak (W)			
3	1.35	16.5	50	5,000	xx	± 0.7 ⁽¹⁾	R420 0xx 110
Available attenuation value: xx = 03, 06, 10 and 20 dB							
3	1.3	17.7	100	5,000	xx	± 1 ⁽¹⁾	R420 7xx 110
Available attenuation value: xx = 03, 06, 10 and 20 dB							

⁽¹⁾ up to xx = 10

N - 50 OHMS, MALE TO FEMALE

Frequency DC to (GHz)	VSWR max.	Return loss min. (dB)	Power rating (W)		Nom. Attenuation (dB)	Max dev.	Part Number
			Avg. (W)	Peak (W)			
3	1.35	16.5	50	5,000	xx	± 0.7 ⁽¹⁾	R417 0xx 110
Available attenuation value: xx = 03, 06, 10, 20 and 30 dB							
2	1.25	19.1	100	5,000	xx	± 1	R417 7xx 118
Available attenuation value: xx = 03, 06, 10 and 20 dB							

⁽¹⁾ up to xx = 10

N - 50 OHMS, MALE TO FEMALE, CONDUCTION AND CONVECTION COOLING

Frequency DC to (GHz)	VSWR max.	Return loss min. (dB)	Power rating (W)		Nom. Attenuation (dB)	Max dev.	Part Number
			Avg. (W)	Peak (W)			
3	1.35	16.5	40 / 50	5,000	xx	± 0.7 ⁽¹⁾	R417 0xx 120
Available attenuation value: xx = 03, 06, 10, 20 and 30 dB							
2	1.25	19.1	80 / 100	5,000	xx	± 1	R417 7xx 128
Available attenuation value: xx = 03, 06, 10 and 20 dB							

⁽¹⁾ up to xx = 10

N - 50 OHMS, MALE TO FEMALE, CONDUCTION COOLING

Frequency DC to (GHz)	VSWR max.	Return loss min. (dB)	Power rating (W)		Nom. Attenuation (dB)	Max dev.	Part Number
			Avg. (W)	Peak (W)			
3	1.35	16.5	50	5,000	xx	± 0.7 ⁽¹⁾	R417 0xx 130
Available attenuation value: xx = 03, 06, 10, 20 and 30 dB							
2	1.25	19.1	100	5,000	xx	± 1	R417 7xx 138
Available attenuation value: xx = 03, 06, 10 and 20 dB							

⁽¹⁾ up to xx = 10

SMA - 50 OHMS, MALE TO FEMALE

Frequency DC to (GHz)	VSWR max.	Return loss min. (dB)	Power rating (W)		Nom. Attenuation (dB)	Max dev.	Part Number
			Avg. (W)	Peak (W)			
3	1.35	16.5	50	5,000	xx	± 0.7 ⁽¹⁾	R417 1xx 110
Available attenuation value: xx = 03, 06, 10, 20 and 30 dB							
2	1.25	19.1	100	5,000	xx	± 1	R417 8xx 118
Available attenuation value: xx = 03, 06, 10 and 20 dB							

⁽¹⁾ up to xx = 10

SMA - 50 OHMS, MALE TO FEMALE, CONDUCTION AND CONVECTION COOLING

Frequency DC to (GHz)	VSWR max.	Return loss min. (dB)	Power rating (W)		Nom. Attenuation (dB)	Max dev.	Part Number
			Avg. (W)	Peak (W)			
3	1.35	16.5	50	5,000	xx	± 0.7 ⁽¹⁾	R417 1xx 120
Available attenuation value: xx = 03, 06, 10, 20 and 30 dB							
2	1.25	19.1	100	5,000	xx	± 1	R417 8xx 128
Available attenuation value: xx = 03, 06, 10 and 20 dB							



High power attenuators, up to 100 watts

SMA - 50 OHMS, MALE TO FEMALE, CONDUCTION COOLING

Frequency DC to (GHz)	VSWR max.	Return loss min. (dB)	Power rating (W)		Nom. Attenuation (dB)	Max dev.	Part Number
			Avg. (W)	Peak (W)			
3	1.35	16.5	50	5,000	xx	± 0.7 ⁽¹⁾	R417 1xx 130
Available attenuation value: xx = 03, 06, 10, 20 and 30 dB							
2	1.25	19.1	100	5,000	xx	± 1	R417 8xx 138
Available attenuation value: xx = 03, 06, 10 and 20 dB							

⁽¹⁾ up to xx = 10

TNC - 50 OHMS, MALE TO FEMALE

Frequency DC to (GHz)	VSWR max.	Return loss min. (dB)	Power rating (W)		Nom. Attenuation (dB)	Max dev.	Part Number
			Avg. (W)	Peak (W)			
3	1.35	16.5	50	5,000	xx	± 0.7 ⁽¹⁾	R417 2xx 110
Available attenuation value: xx = 03, 06, 10, 20 and 30 dB							
2	1.25	19.1	100	5,000	xx	± 1	R417 9xx 118
Available attenuation value: xx = 03, 06, 10 and 20 dB							

⁽¹⁾ up to xx = 10

TNC - 50 OHMS, MALE TO FEMALE, CONDUCTION AND CONVECTION COOLING

Frequency DC to (GHz)	VSWR max.	Return loss min. (dB)	Power rating (W)		Nom. Attenuation (dB)	Max dev.	Part Number
			Avg. (W)	Peak (W)			
3	1.35	16.5	50	5,000	xx	± 0.7 ⁽¹⁾	R417 2xx 120
Available attenuation value: xx = 03, 06, 10, 20 and 30 dB							
2	1.25	19.1	100	5,000	xx	± 1	R417 9xx 128
Available attenuation value: xx = 03, 06, 10 and 20 dB							

⁽¹⁾ up to xx = 10

TNC - 50 OHMS, MALE TO FEMALE, CONDUCTION COOLING

Frequency DC to (GHz)	VSWR max.	Return loss min. (dB)	Power rating (W)		Nom. Attenuation (dB)	Max dev.	Part Number
			Avg. (W)	Peak (W)			
3	1.35	16.5	50	5,000	xx	± 0.7 ⁽¹⁾	R417 2xx 130
Available attenuation value: xx = 03, 06, 10, 20 and 30 dB							
2	1.25	19.1	100	5,000	xx	± 1	R417 9xx 138
Available attenuation value: xx = 03, 06, 10 and 20 dB							

⁽¹⁾ up to xx = 10



Platinum attenuators, up to 2 watts

Radiall's platinum series of attenuators are designed for test & measurement applications. This range can be easily integrated in communication matrices, test benches and laboratories where high RF performance and reliability are essential.

Here are the main features of Radiall's platinum series of terminations:

- 2W power rating
- Frequency from DC up to 40 GHz
- 50Ω Impedance
- Attenuation value from 0 to 30 dB
- Lowest VSWR for test applications
- Compatibility with all standards Test & Measurement interfaces
- Connector interface according to applicable MIL, DIN, NF and CEI
- Full integration in Radiall Test & Measurement offer: Electro-mechanical switches & TestPro cable Assemblies



SMA2.9 - 50 OHMS, MALE TO FEMALE

Frequency DC to (GHz)	VSWR max.	Return loss min. (dB)	Power rating (W)	Impedance Ω	Nom. Attenuation	Max dev.	Part Number
40	1.45	14.71907141	2	50	xx	±0.5 dB	R413 3xx 150
Available attenuation value: xx = 03, 06, 10, 20, 30 dB							

SMA3.5 - 50 OHMS, MALE TO FEMALE

Frequency DC to (GHz)	VSWR max.	Return loss min. (dB)	Power rating (W)	Impedance Ω	Nom. Attenuation	Max dev.	Part Number
26.5	1.35	16.53999636	2	50	xx	±0.4 dB	R413 2xx 150
Available attenuation value: xx = 03, 06, 10, 20, 30 dB							

SMA - 50 OHMS, MALE TO FEMALE

Frequency DC to (GHz)	VSWR max.	Return loss min. (dB)	Power rating (W)	Impedance Ω	Nom. Attenuation	Max dev.	Part Number
18	1.3	17.69213163	2	50	xx	±0.4 dB	R413 8xx 150
Available attenuation value: xx = 03, 06, 10, 20, 30 dB							

N - 50 OHMS, MALE TO FEMALE

Frequency DC to (GHz)	VSWR max.	Return loss min. (dB)	Power rating (W)	Impedance Ω	Nom. Attenuation	Max dev.	Part Number
18	1.12	24.9430923	2	50	xx	±0.4 dB	R414 7xx 150
Available attenuation value: xx = 03, 06, 10, 20, 30 dB							

TNC - 50 OHMS, MALE TO FEMALE

Frequency DC to (GHz)	VSWR max.	Return loss min. (dB)	Power rating (W)	Impedance Ω	Nom. Attenuation	Max dev.	Part Number
12.4	1.1	26.44438589	2	50	xx	±0.4 dB	R414 5xx 150
Available attenuation value: xx = 03, 06, 10, 20, 30 dB							

BNC - 50 OHMS, MALE TO FEMALE

Frequency DC to (GHz)	VSWR max.	Return loss min. (dB)	Power rating (W)	Impedance Ω	Nom. Attenuation	Max dev.	Part Number
4	1.1	26.44438589	2	50	xx	±0.4 dB	R414 4xx 150
Available attenuation value: xx = 03, 06, 10, 20, 30 dB							



Introduction

COAXIAL COUPLERS

3dB hybrid couplers and directional couplers are passive devices used in the microwave field. A directional coupler is a reciprocal 4 port device. When a signal is applied to its input port, it provides 2 amplitude ports, coupling is the ratio in dB of the incident power fed into the input port of the main line of the directional coupler to the coupled port of the secondary line when all ports are terminated on matched load. A 3dB Hybrid coupler is a special class of directional couplers in which signals at the two outputs are equal to split RF signal in 2 equal parts or to combine 2 RF signals on one port.

Directional couplers and power dividers have many applications, these include; providing a signal sample for measurement or monitoring, feedback, combining feeds to and from antennas, antenna beam forming.

SPECIAL DEVICES

Feed through terminations

These components are used to properly terminate a transmission line while testing with a high impedance measuring system such as an oscilloscope input.

Detectors

A detector is a 2 port device capable of supplying a low frequency signal on its output port (video), of a level proportional of the RF power applied to its input port. This proportionality is achieved by means of non linearity property of the diodes used which at low level supply a detected voltage proportional to the RF voltage.

Rotary joints

These components provide the transition between two coaxial transmission lines rotating with respect to each other while retaining acceptable RF characteristics.

DC blocks

DC blocks are composed of a capacitor inserted to the the central conductor of the coaxial line. They block any DC or low frequency current present on the line.

Signal samplers

These devices are used to sample part of an RF signal from a coaxial line. They are not directive, and sample incident and reflected energy.

Phase shifters

These components create a mechanically adjustable phase shift by variation in the physical length of the transmission line.



Our Most Important Connection is with You.™

Couplers

3 dB 90° HYBRID COUPLERS

Frequency (GHz)	Amplitude Balance (dB)	Phase Balance	Input Power (W)		Max Insertion Loss (dB) Attenuation (dB)	Min Isolation (dB)	VSWR max.	Connectors main / coupled	Part Number
			Ave. ⁽¹⁾	Peak ⁽²⁾					
0.15 - 0.3	± 0.5	90° ± 0.5°	500	5,000	0.3	30	1.15	N f / N f	R432 171 000
0,25 - 0.5	± 0.5	90° ± 5°	500	5,000	0.3	30	1.15	N f / N f	R432 271 000
0.5 - 1	± 0.5	90° ± 5°	300	5,000	0.3	25	1.15	N f / N f	R432 371 000
1 - 2	± 0.5	90° ± 5°	100	3,000	0.3	25	1.2	SMA f / SMA f	R432 431 000
1 - 2	± 0.5	90° ± 5°	200	5,000	0.3	25	1.2	N f / N f	R432 471 000
2 - 4	± 0.5	90° ± 5°	80	3,000	0.3	23	1.2	SMA f / SMA f	R432 531 000
2 - 4	± 0.5	90° ± 5°	80	3,000	0.3	20	1.2	N f / N f	R432 571 000
4 - 8	± 0.5	90° ± 5°	50	3,000	0.3	19	1.25	SMA f / SMA f	R432 631 000
7 - 12,4	± 0.5	90° ± 6°	30	3,000	0.4	18	1.35	SMA f / SMA f	R433 721 700
6 - 18	± 0.6	90° ± 6°	30	3,000	0.6	15	1.5	SMA f / SMA f	R433 611 700
12,4 - 18	± 0.7	90° ± 6°	30	3,000	0.6	16	1.4	SMA f / SMA f	R433 831 700

⁽¹⁾ at 25°C

⁽²⁾ at 25°C (1us - duty cycle 1%)

DIRECTIONAL COUPLERS

(all directional couplers are loaded with SMA 50 Ohms termination)

Frequency (GHz)	Amplitude Balance (dB)	Phase Balance	Input Power (W)		Max Insertion Loss ⁽³⁾ (dB) Attenuation (dB)	Directivity (dB)	VSWR max. ⁽⁴⁾	Connectors main / coupled	Part Number
			Ave. ⁽¹⁾	Peak ⁽²⁾					
0.15 - 0.3	6 ± 0.3	± 0.8	500	5,000	2	30	1.10 / 1.10	N f / N f	R432 172 000
0.15 - 0.3	10 ± 0.3	± 0.8	500	5,000	1	30	1.10 / 1.10	N f / N f	R432 173 000
0.15 - 0.3	20 ± 0.3	± 0.8	500	5,000	0.4	30	1.10 / 1.10	N f / N f	R432 174 000
0.15 - 0.3	30 ± 0.3	± 0.8	500	5,000	0.4	30	1.10 / 1.10	N f / N f	R432 175 000
0.25 - 0.5	10 ± 0.3	± 0.8	500	5,000	1	30	1.12 / 1.12	N f / N f	R432 273 000
0.25 - 0.5	20 ± 0.3	± 0.8	500	5,000	0.4	30	1.12 / 1.12	N f / N f	R432 274 000
0.25 - 0.5	30 ± 0.3	± 0.8	500	5,000	0.4	30	1.12 / 1.12	N f / N f	R432 275 000
0.5 - 1	6 ± 0.3	± 0.8	300	5,000	2	25	1.15 / 1.15	N f / N f	R432 372 000
0.5 - 1	10 ± 0.3	± 0.8	300	5,000	1	27	1.15 / 1.15	N f / N f	R432 373 000
0.5 - 1	20 ± 0.3	± 0.8	300	5,000	0.4	27	1.15 / 1.15	N f / N f	R432 374 000
0.5 - 1	30 ± 0.3	± 0.8	300	5,000	0.4	27	1.15 / 1.15	N f / N f	R432 375 000
1 - 2	6 ± 1.1	± 0.8	100	3,000	1.8	23	1.20 / 1.20	SMA f / SMA f	R432 432 000
1 - 2	10 ± 0.3	± 0.8	100	3,000	1	23	1.15 / 1.15	SMA f / SMA f	R432 433 000
1 - 2	20 ± 0.3	± 0.8	100	3,000	0.4	23	1.15 / 1.15	SMA f / SMA f	R432 434 000
1 - 2	30 ± 0.3	± 0.8	100	3,000	0.4	23	1.15 / 1.15	SMA f / SMA f	R432 435 000
1 - 2	6 ± 0.3	± 0.6	200	5,000	2.25	23	1.15 / 1.15	N f / N f	R432 472 000
1 - 2	10 ± 0.3	± 0.8	200	5,000	1	23	1.15 / 1.15	N f / N f	R432 473 000
1 - 2	20 ± 0.3	± 0.8	200	5,000	0.4	23	1.15 / 1.15	N f / N f	R432 474 000
1 - 2	30 ± 1.1	± 0.8	200	5,000	0.4	23	1.15 / 1.15	N f / N f	R432 475 000
2 - 4	10 ± 0.3	± 0.8	80	3,000	1	20	1.15 / 1.15	SMA f / SMA f	R432 533 000



Couplers

Frequency (GHz)	Amplitude Balance (dB)	Phase Balance	Input Power (W)		Max Insertion Loss ⁽³⁾ (dB) Attenuation (dB)	Directivity (dB)	VSWR max. ⁽⁴⁾	Connectors main / coupled	Part Number
			Ave. ⁽¹⁾	Peak ⁽²⁾					
2 - 4	10 ± 0.3	± 0.8	100	3,000	0.4	20	1.15 / 1.15	N f / N f	R432 573 000
2 - 4	20 ± 0.3	± 0.8	80	3,000	0.4	20	1.15 / 1.15	SMA f / SMA f	R432 534 000
2 - 4	20 ± 0.3	± 0.8	100	3,000	0.4	20	1.15 / 1.15	N f / N f	R432 574 000
2 - 4	30 ± 1.1	± 0.8	80	3,000	0.4	20	1.15 / 1.15	SMA f / SMA f	R432 535 000
4 - 8	10 ± 0.3	± 0.8	50	3,000	1	17	1.20 / 1.20	SMA f / SMA f	R432 633 000
4 - 8	20 ± 0.3	± 0.8	50	3,000	0.4	17	1.20 / 1.20	SMA f / SMA f	R432 634 000
4 - 8	30 ± 0.3	± 0.8	50	3,000	0.4	17	1.20 / 1.20	SMA f / SMA f	R432 635 000

⁽¹⁾ at 25°C
⁽²⁾ at 25°C (1us - duty cycle 1%)
⁽³⁾ coupling loss included
⁽⁴⁾ main line / coupled line

FLAT FREQUENCY RESPONSE DIRECTIONAL COUPLERS
 (all directional couplers are loaded with SMA 50 Ohms termination)

Frequency (GHz)	Coupling ⁽⁴⁾ (dB)	Frequency sensitivity ⁽⁴⁾ ± (dB)	Input Power(W)		Max Insertion Loss ⁽⁵⁾ (dB) Attenuation (dB)	Directivity (dB)	VSWR max. ⁽³⁾	Connectors main / coupled	Part Number
			Ave. ⁽¹⁾	Peak ⁽²⁾					
0.9 - 2.1	10 ± 0.8	± 0.3	50	3,000	1	22	1.15 / 1.15	SMA f / SMA f	R433 423 000
0.9 - 2.1	10 ± 0.5	± 0.3	50	3,000	1	22	1.20 / 1.20	N f / N f	R433 463 000
0.9 - 2.1	20 ± 0.8	± 0.3	50	3,000	0.4	22	1.15 / 1.15	SMA f / SMA f	R433 424 000
0.9 - 2.1	20 ± 0.5	± 0.3	50	3,000	0.4	22	1.20 / 1.20	N f / N f	R433 464 000
1.7 - 4.2	10 ± 0.8	± 0.3	50	3,000	1	20	1.20 / 1.20	SMA f / SMA f	R433 523 000
1.7 - 4.2	10 ± 0.5	± 0.3	50	3,000	1	20	1.25 / 1.25	N f / N f	R433 563 000
1.7 - 4.2	20 ± 0.8	± 0.3	50	3,000	0.4	20	1.20 / 1.20	SMA f / SMA f	R433 524 000
1.7 - 4.2	20 ± 0.8	± 0.4	50	3,000	0.4	20	1.25 / 1.25	N f / N f	R433 564 000
3.7 - 8.3	10 ± 0.5	± 0.3	50	3,000	1	18	1.25 / 1.25	SMA f / SMA f	R433 623 000
3.7 - 8.3	10 ± 0.5	± 0.3	50	3,000	1	18	1.30 / 1.30	N f / N f	R433 663 000
3.7 - 8.3	20 ± 0.5	± 0.3	50	3,000	0.4	18	1.25 / 1.25	SMA f / SMA f	R433 624 000
3.7 - 8.3	20 ± 0.5	± 0.3	50	3,000	0.4	18	1.30 / 1.30	N f / N f	R433 664 000
2 - 8	10 ± 1	± 0.4	50	3,000	1	20	1.25 / 1.25	SMA f / SMA f	R433 513 700
2 - 8	20 ± 1	± 0.4	50	3,000	0.4	20	1.25 / 1.25	SMA f / SMA f	R433 514 700
7 - 12.4	10 ± 1	± 0.5	50	3,000	1	16	1.30 / 1.30	SMA f / SMA f	R433 723 700
7 - 12.4	20 ± 1	± 0.5	50	3,000	0.4	16	1.30 / 1.30	SMA f / SMA f	R433 724 700
2 - 18	10 ± 1	± 0.6	20	3,000	1.4	12	1.35 / 1.50	SMA f / SMA f	R433 503 000
6 - 18	6 ± 1	± 0.5	50	3,000	2.2	15	1.40 / 1.40	SMA f / SMA f	R433 612 700
6 - 18	10 ± 1	± 0.5	50	3,000	1.1	16	1.40 / 1.40	SMA f / SMA f	R433 613 700
6 - 18	20 ± 1	± 0.5	50	3,000	0.6	15	1.40 / 1.40	SMA f / SMA f	R433 614 700
12.4 - 18	6 ± 1	± 0.5	50	3,000	2.2	15	1.40 / 1.40	SMA f / SMA f	R433 832 700
12.4 - 18	10 ± 1	± 0.5	50	3,000	1.1	15	1.35 / 1.35	SMA f / SMA f	R433 833 700
12.4 - 18	20 ± 1	± 0.5	50	3,000	0.55	15	1.35 / 1.35	SMA f / SMA f	R433 834 700

⁽¹⁾ at 25°C
⁽²⁾ at 25°C (1us - duty cycle 1%)
⁽³⁾ main line / coupled line
⁽⁴⁾ frequency sensitivity is included in coupling
⁽⁵⁾ coupling loss included



Special devices

FEED THROUGH TERMINATION BNC - 50 AND 75 OHMS

Frequency DC to (GHz)	VSWR max.	Return loss min. (dB)	Power		VSWR max.	Connectors main / coupled	Part Number
			Ave.(W)	Peak(W)			
1	1.35	16.5	2	1,000	50±5%	m / f straight	R405 005 000
1	1.35	16.5	2	1,000	50±5%	m / f right angle	R405 035 000
1	1.35	16.5	2	1,000	75±5%	m / f straight	R405 006 000

WIDE BAND DETECTORS (all detectors use Schottky zero bias diode. They are 50 Ohms -12dBm. CW = 200 mw, peak power 2 W)

Frequency (GHz)	Connectors		Part Number	
	Input HF	Output Video	Negative	Positive
0.01 - 18	SMA m	SMB m	R451 533 000	R451 533 500
0.01 - 18	SMA m	SMC m	R451 534 000	R451 534 500
0.01 - 18	SMA m	SMA f	R451 542 000	R451 542 500
0.01 - 18	SMA m	pin	R451 543 000	R451 543 500
0.01 - 18	SMA m	BNC f	R451 544 000	R451 544 500
0.01 - 12.4	N m	BNC f	R451 574 000	R451 574 500
0.01 - 18	N m	BNC f	R451 576 000	R451 576 500
2.45	N m	BNC f	R451 572 120	

HIGH SENSIBILITY DETECTORS (all detectors use Schottky zero bias diode. They are 50 Ohms -12dBm. CW = 200 mw, peak power 2 W)

Frequency (GHz)	Connectors		Part Number	
	Input HF	Output Video	Negative	Positive
1 - 18	SMA m	SMB m	R451 030 000	R451 030 500
1 - 18	SMA m	SMC m	R451 031 000	R451 031 500
1 - 18	SMA m	SMA f	R451 032 000	R451 032 500
1 - 18	SMA m	Pin	R451 033 000	R451 033 500
1 - 18	SMA m	BNC f	R451 034 000	R451 034 500

DIODE HOLDER DETECTORS

Frequency (GHz)	Connectors		Part Number	
	Input HF	Output Video	Negative	Positive
0.01 - 4	N m	BNC f	R451 570 000	R451 570 500
0.01 - 10	N m	BNC f	R451 075 000	

ROTARY JOINTS

Frequency DC to (GHz)	VSWR max.	Max V.S.W.R. variation per turn	Insertion Loss (dB) Max.	Power max	Part Number
18	1.5	1.02	0.60	50	R447 120 000
18	1.5	1.02	0.80	40	R447 171 000



Special devices

DC BLOCKS : INNER CONDUCTOR BLOCK TYPE

Frequency (GHz)	Capacitance (pF)	VSWR max.	Insertion Loss (dB) Max.	Connectors	Main line Max DC Voltage (Volts)	Part Number
0.01 - 6	4700	1.30	0.50	SMA m/f	63	R443 131 000
1 - 12.4	100	1.25	0.50	SMA m/f	300	R443 134 000
0.01 - 6	4700	1.30	0.50	BNC m/f	63	R443 141 000
0.01 - 6	4700	1.30	0.50	TNC m/f	63	R443 151 000
0.01 - 6	4700	1.30	0.50	N m/f	63	R443 171 000
0.01 - 6	4700	1.30	0.50	QMA m/f	63	R443 191 000
0.5 - 22	180	1.25	0.50	SMA m/f	100	R443 137 000
0.1 - 40	180	1.35	0.60	SMA2.9	100	R443 162 000

MONITOR TEES

Frequency (GHz)	Nominal capacity (pF)	VSWR max.	Insertion Loss (dB) Max.	Max average Power (W)	Connectors	Part Number
0.01 - 1.5	15000	1.30	0.25	50	SMA	R443 530 000
0.9 - 3	10	1.25	0.25	10	SMA	R443 533 480
1.5 - 6	10	1.20	0.40	40	SMA	R443 533 000
6 - 12.4	3.5	1.35	0.50	40	SMA	R443 536 000

SIGNAL SAMPLERS

Frequency DC to (GHz)	Coupling Variation (W)	VSWR max.	Insertion Loss (dB) Max.	Connectors main line	Connector coupled line	Part Number
12.4	6 / Octave	1.50	0.20	N male/female	BNC	R435 270 000 ⁽¹⁾
12.4	6 / Octave	1.50	0.20	N male/female	BNC	R435 170 000 ⁽²⁾
12	6 / Octave	1.50	0.20	N male/female	BNC	R435 470 000 ⁽³⁾

⁽¹⁾ Loop probe, ⁽²⁾ Resistive loop probe, ⁽³⁾ Capacitive probe

PHASE SHIFTERS

Frequency DC to (GHz)	Total Phase Variation	VSWR max.	Connectors	Part Number
18	180° [18GHz]	1.30	SMA male / female	R499103000
18	180° [18GHz]	1.30	SMA male to S.R. .141 cable	R499101000



Banana Plugs

R644 / R921 / R929 / R941 / R948 / R995 / R999



Contents

BANANA PLUGS

Introduction 20-4 to 20-5
 Finder guide 20-6 to 20-7

4MM SERIES

Introduction 20-8
 Characteristics 20-9
 Packaging 20-9
 Safety series - Plugs 20-10
 - Sockets 20-11
 - Patch cords 20-11 to 20-13
 Standard series - Plugs 20-14 to 20-15
 - Sockets 20-15
 - Patch cords 20-16 to 20-17
 Accessories 20-18

2MM SERIES

Introduction 20-19 to 20-20
 Characteristics 20-21 to 20-22
 Packaging 20-22
 Plugs 20-23 / 20-25
 Sockets 20-24
 Patch cords 20-24
 20 way fixed connectors 20-26
 Contact blocks 20-27
 Ribbon patch cords 20-28
 Accessories 20-28

BANANA ADAPTERS

Introduction 20-29
 Characteristics 20-29
 Packaging 20-29
 Adapters 20-30
 Adapters patch cords 20-31
 Panel drilling 20-32

Introduction

Radiall offers a wide selection of high quality and reliable professional banana plugs for the most demanding test and measurement applications.

Radiall's professional banana plugs consist of two major series and adapters:

The 4mm Series

- Safety plugs and sockets
- Safety patch cords
- Standard plugs and sockets
- Standard patch cords
- Accessories

The 2mm Series

- Plugs and sockets
- Patch cords
- PCB test points
- 20-way fixed connector
- Short circuit links
- Contact block and ribbon patch cords
- Accessories

Adapters

- 2mm/4mm banana adapter
- BNC/2mm banana adapter
- BNC/4mm banana adapter
- Banana adapter patch cord
- Coaxial banana adapter patch cord



Applications

- Research institutes and laboratories
- Education
- Instrumentations
- Low voltage
- Electronics
- Engineering

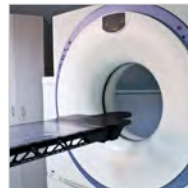

Introduction

FEATURES AND BENEFITS

Radiall's in-house technologies ensure high reliable product solutions due to its expertise and advanced design technology.

Radiall's contacts consists of a monobloc pin fitted with a copper beryllium spring finger. Depending on the model, the pin may or may not have a protective sleeve.

	4mm series	2mm series
Contact resistance	0.5 mΩ	1mΩ
Current rating, max @ 20 ° C	30 A	10 A
Contact durability, min.	10,000 mating cycles	

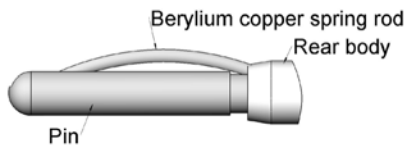

Benefits





- Excellent electrical conduction
- Very low contact resistance
- Robust contact point pressure when connected
- High durability for high number of mating cycles

GLOSSARY OF ABBREVIATIONS







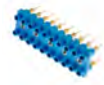

Abbreviation series		Destination
4mm	2mm	
B1	BL-I	Insulated plug with solder connection
B2		Insulated plug with crimp or solder connection
	BL-PI	Insulated panel plug
B4	BL	Uninsulated plug
	BL2-4	Uninsulated threaded plug
	BLP-4	Uninsulated panel plus with solder connection
DPI	DL-PL	Insulated panel socket
DPIS		Insulated safety panel socket
DP	DLP	Uninsulated panel socket
	BLP D-2	Uninsulated panel plug/2mm dia. socket
BDR-4	BDR-2	Stackable plug with quick grip cable clamp
BDR-SR		Stackable plug, partial safety
BDR-PR		Stackable plug, partial safety non thermofusible sleeve
BDM	BLDM	Stackable patch cord
BDSA		Stackable patch cord, total safety
BDSR		Stackable patch cord, partial safety
BM	BLM	Extension patch cord
DM	DLM	Extension female patch cord
PTM		Test probe patch cord
	FL	Contact block
	ML	Ribbon patch cords

4MM/2MM SERIES

Finder guide

Series	Image	Category	Description	Page	
4mm		Banana plugs	Stackable plug (BDR-SR)	11	
			Stackable plug, non-thermofusible sleeve (BDR-PR)		
		Panel sockets	Insulated safety panel socket (DPIS)	12	
			Plug/Plug stackable, retractable sleeve (BDSA)		
		Patch cords	Plug/Plug stackable, non-retractable sleeve (BDSA)	13	
			Patch cords made to order		
		Banana plugs	Uninsulated plug (B4)	14	
			Insulated plug with solder connection (B1)		
			Insulated plug with crimp or solder connection (B2)		
			Stackable plug with quick grip cable clamp (BDR-4)		
		Panel sockets	Uninsulated panel sockets (DP)	15	
			Insulated panel sockets (DP)		
		Patch cords	BM/BM extension patch cords	16	
			BDM/BDM stackable patch cords		
			PTM/BM Test probe patch cords		
			Patch cords made to order	17	
			Accessories and Adapter	Test clip - with alligator clip	18
				Test clip - with flexible steel rod	
Crocodile clip					
Safety test probe					
Safety female - female adapter					
2mm		Banana plugs	Uninsulated plug with crimp or solder connection (BL)	23	
			Uninsulated panel plug with solder connection (BLP-4)		
			Uninsulated panel plug/2mm dia. socket (BLP D-2)		
			Insulated plugs with solder connection (BL-I)		
			Insulated panel plug (BL-PI)		
		Stackable plug with quick grip cable clamp (BDR-2)			
	Panel sockets	Uninsulated panel sockets (DLP)	24		
		Insulated panel sockets (DL-PI)			
	Patch cords	BLM extension patch cords	25		
		BLDM stackable patch cords			
		Patch cords made to order			

Finder guide

Series	Image	Category		Description	Page	
2mm		Standard series	Multi-contact 20-way fixed connectors	Solder cup - 12mm contact pitch	26	
				Solder cup - 6mm contact pitch		
				Pin - 12mm contact pitch		
				Pin - 6mm contact pitch		
		Standard series	Short cut circuit	12mm contact pitch		
				6mm contact pitch		
		Contact Blocks & Ribbon patch cords	Contact blocks	Male contact blocks (FL M)		27
				Female contact blocks (FL F)		
		Contact Blocks & Ribbon patch cords	Patch leads	Male - male ribbon patch cords (ML MM)		28
				Female - female ribbon patch cords (ML FF)		
	Accessories		PCB Test socket	30		
			Test probe			
	Accessories					
Adapters		Banana adapters	Banana adapters	2mm male - 4mm female	32	
			BNC/Banana adapters	BNC/2mm Banana adapter		
				BNC/4mm Banana adapter		
		Banana adapters patch cords		BLM/BM		33
				BLDM/BDM		
				BLM/DM		
	Coaxial patch cords		BNC/BCX			

Introduction

4mm SAFETY SERIES

Due to safety being an important criteria when using test and measurement instrumentation, especially for high voltage use, Radiall developed the 4mm Safety Series, which offers an improved protection system that eliminates all risk of contact with live elements when handling components.

Safety connectors are reinforced by a protective sleeve and an insulation cap on the top of the contact. The protective sleeve may be retractable or non-retractable. All plugs with non-retractable sleeves are rated at 600V, CAT III or 1000V, CAT II according to the safety standard IEC 61010-031 version 2002.

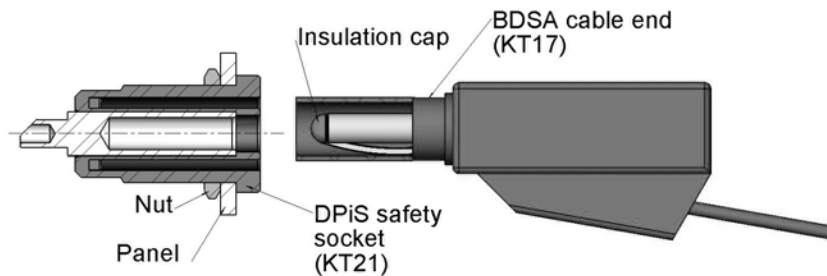

4mm STANDARD SERIES

The 4mm Standard Series meets the requirements of NF C 93 440 standards. The product in this series are not intended for hand-held use at voltage above 30Vac/60Vdc.

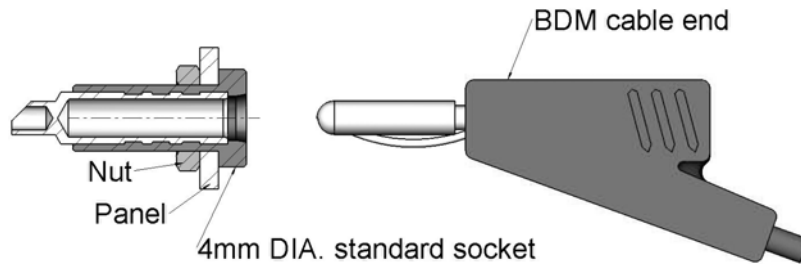

Example of a regular connection: the contact is exposed.

ACCESSORIES: TEST CLIPS

- With sliding hook: The contact hook guarantees a good grip on wires, components and PCB pin up to 1.5mm² thick.
- Alligator Test Clips: Features a large opening and gripping efficiency for use on motors, fuse holders, terminals, etc.
- Flexible Steel Rod Test Clips: The thin flexible steel rod allows testing of hard-to-reach points in dense circuitry.
- Crocodile Test Clips: Features a large 20mm opening to allow attachment to larger test points.
- Safety Test Probe: An extra thin probe allows contact through coatings and some insulations. It can also be used for PCB measurements. Fitted with a rear-mounted 4mm socket, it can be used with BM patch cords.

Characteristics

	Plugs	Sockets	Patch Cords
--	-------	---------	-------------

ELECTRICAL CHARACTERISTICS

Current rating, max. • 4mm safety • 4mm standard	30A (@ 20 °C)	15 A (@ 20 °C) patch cords 1mm ² 15 A (@ 20 °C) patch cords 1mm ² 30 A (@ 20 °C) 2 an 2.5mm ²
Dielectric withstanding voltage	2500 Vrms @ 50Hz	
Operating voltage	750 Vrms @ 50Hz	
Insulation resistance, min.	5000 MΩ	
Contact resistance, max.	0.5mΩ	

MECHANICAL CHARACTERISTICS

Mechanical, durability, min.	10,000 matings		
Average insertion force	25N		
Tightening torque • 4mm safety • 4mm standard		Max 140 N.cm 120 Ncm	

ENVIRONMENTAL CHARACTERISTICS

Temperature range • 4mm safety • 4mm standard	-40 °C / +85 °C	-40 °C / +100 °C	BDSR patch cords -40 °C / +85 °C BDSA patch cords -25MC / +70 °C
Damp heat	(uninsulated) -65 °C / +155 °C (insulated models) -60 °C / +100 °C		-40 °C / +70 °C

MATERIALS

Insulation	Thermoplastic		
Contacts	Nickel or tin plated Copper alloy/brass		

Characteristics accessories

	with Sliding Hook	with Alligator Clip	with Flexible Steel Rods	with Crocodile Die	Safety Test Probe
--	-------------------	---------------------	--------------------------	--------------------	-------------------

ELECTRICAL CHARACTERISTICS

Operating voltage, max.	1000 Vrms				1500 Vrms
Current rating max	4A (@20 °C)	2.5A	32A	32A	
Clip opening (max)	1.5mm (max hooking capacity)	-	-	20mm	-

MATERIALS

Body	Thermoplastic				
Contact	Stainless steel				Steel

Packaging

	2mm Safety Series	4mm Standard Series
Plugs	10 pieces	100 pieces
Panel sockets		100 pieces
Patch cords		10 pieces
Accessories		10 pieces

Plugs

STACKABLE PLUG, PARTIAL SAFETY (BDR-SR)

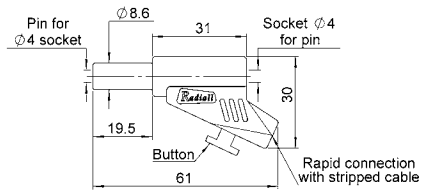

Part number	Color	Standard
R941 460 600	Black	NFC 93440-KT12R
R941 461 600	Red	
R941 462 600	Green	
R941 463 600	Blue	
R941 464 600	Yellow	

STACKABLE PLUG, PARTIAL SAFETY-NON-THERMOFUSIBLE SLEEVE (BDR-PR)

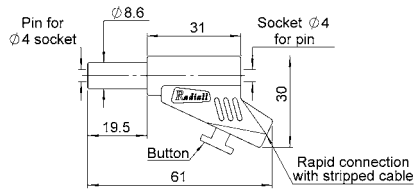

Part number	Color	Standard
R941 480 600	Black	NFC 93440-KT12R
R941 481 600	Red	DCN 5935 BA

Sockets

INSULATED SAFETY PANEL-MOUNT SOCKETS (DPIS)

Insulated safety panel sockets are mateable with standard 4mm BM/BDM patch cords and BDSR/BDSA safety patch cords.

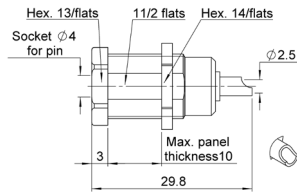

Part number	Color	Termination	Standard	Panel drilling
R941 920 600	Black	Solder cup	NFC 93440-KT21F	P05
R941 921 600	Red			
R941 922 600	Green			
R941 923 600	Blue			
R941 924 600	Yellow			

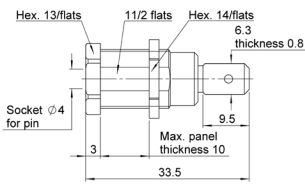

Part number	Color	Termination	Standard	Panel drilling
R941 920 602	Black	Flat for FASTON lug type	NFC 93440-KT21L	P05
R941 921 602	Red			

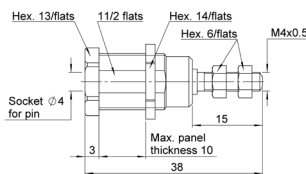

Part number	Color	Termination	Standard	Panel drilling
R941 920 603	Black	For fork lug	NFC 93440-KT21V	P05
R941 921 603	Red			
R941 924 603	Yellow			

Patch cords

Except where specified, all patch cords lengths are defined by the length of the cable without connectors or strain relief.

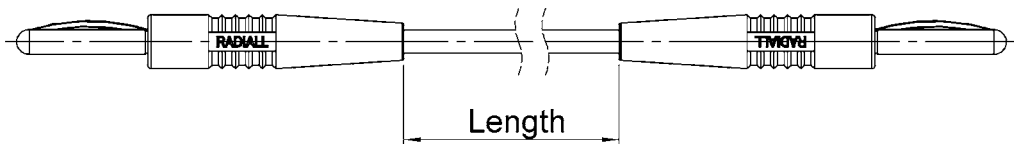

Radiall Patch Cord Series includes:

- **BDSR/BDSR:** Retractable sleeve for partial security
- **BDSA/BDSA:** Non-retractable sleeve where secure connections are critical; The cable assembly is rated at 1000V, CAT II according to the safety standard IEC61010-31
- **Patch cords made-to-order**

Patch cords

PLUG/PLUG STACKABLE PATCH CORDS - RETRACTABLE SLEEVE (BDSR/BDSR)

Cable type:

- PVC, 1mm² conductor, 3.5mm insulation
- PVC, 2mm² conductor, 3.5mm insulation
- Silicone, 2.5mm² conductor, 4mm insulation



R948 1xx 6xx

PATCH CORDS LENGTH:

- 3:** 25cm
- 4:** 50cm
- 5:** 100cm
- 6:** 150cm
- 7:** 200cm

COLOR:

- 0:** Black
- 1:** Red

CABLE TYPE:

- 00:** PVC 1mm² 3.5mm
- 02:** PVC 2mm² 3.5mm
- 29:** Silicone 2.5mm² 4mm

PLUG/PLUG STACKABLE PATCH CORDS - NON-RETRACTABLE SLEEVE (BDSA/BDSA)

Cable type:

- PVC, 1mm² conductor, 3.5mm insulation
- PVC, 2mm² conductor, 3.5mm insulation
- Silicone, 2.5mm² conductor, 4mm insulation



R948 3xx 6xx

PATCH CORDS LENGTH:

- 3:** 25cm
- 4:** 50cm
- 5:** 100cm
- 6:** 150cm
- 7:** 200cm

COLOR:

- 0:** Black
- 1:** Red

CABLE TYPE:

- 00:** PVC 1mm² 3.5mm
- 02:** PVC 2mm² 3.5mm
- 29:** Silicone 2.5mm² 4mm

Patch cords

MADE-TO-ORDER PATCH CORDS

Customized patch cords using BDSR plugs can be made-to-order to meet your specifications. Choices include connector style, cable type, color, and cable length.

HOW TO ORDER

	CONNECTOR 1	CABLE TYPE	LENGTH	CONNECTOR 2
BDSR type R949 100 600 / Black R949 101 600 / Red				
PVC, 1mm² C290 110 / Black C290 111 / Red SILICONE, 1mm² C290 010 / Black C290 011 / Red				
XXX: cable length in cm				
BDSR type R949 100 600 / Black R949 101 600 / Red				

EXAMPLE TO ORDER:

1 black BDSR plug / red silicone 1 mm² cable length 125cm / 1 Red BDSR plug.
 Part number: R949 100 600 / C290 011-125cm / R949 100 600

NOTE:

- (1) For other options, please contact your local representative
- (2) Refer to the table below to select your insert class:

Plugs

UNINSULATED BANANA PLUGS

Figure	Part number	Description	Panel drilling
	R941 019 000	Solder or crimp 15mm solder post Strip length: 5mm Crimp tool: Buchanan R612 548 000 Positioner Radiall R282 561 000 Crimp setting: 1.20 (18 AWG) 1.08 (22 AWG) Maxi 15A	
	R941 029 000	Solder or crimp 2mm solder post Strip length: 5mm Crimp tool: Buchanan R612 548 000 Positioner Radiall R282 561 000 Crimp setting: 1.50 (14 AWG) 1.25 (18 AWG)	
	R941 049 000	Threaded panel connection 8mm rear length	P03
	R941 069 000	Threaded panel connection 18mm rear length	P03
	R941 149 000	Panel banana plug 4mm with rear socket for mating with 4mm plug	P01

Plugs

INSULATED BANANA PLUGS

Figure	Part number	Color	Description
	R941 330 000	Black	- Tin-plated solder cup or - Rear socket for 2mm banana plug (14 AWG)
	R941 331 000	Red	
	R941 332 000	Green	
	R941 333 000	Blue	
	R941 334 000	Yellow	
	R941 336 000	White	
	R941 340 000	Black	- Tin-plated solder cup or - Screw tightening or - Rear socket for 2mm banana plug (14 AWG)
	R941 341 000	Red	
	R941 342 000	Green	
	R941 343 000	Blue	
	R941 344 000	Yellow	
	R941 346 000	White	
	R941 460 000	Black	- Stackable banana with quick-grip clamp for stripped cable - 2 & 4mm socket for banana plugs
	R941 461 000	Red	

Sockets

UNINSULATED PANEL SOCKETS (DP)

Figure	Part number	Description	Panel drilling
	R941 619 000	Solder cup Cup tripping dimension 4mm	P01
	R941 629 000 (nickel plated version)	(14 AWG)	

INSULATED PANEL SOCKETS (DPI)

Figure	Part number	Color	Description	Panel drilling
	R941 920 001	Black	Tin-plated solder cup UL 94V-0 thermoplastic insulation	P06
	R941 921 001	Red		
	R941 922 001	Green		
	R941 923 001	Blue		
	R941 924 001	Yellow		
	R941 926 001	White		

Patch cords

Except where specified, all patch cords lengths are defined by the length of the cable without connectors or strain relief.

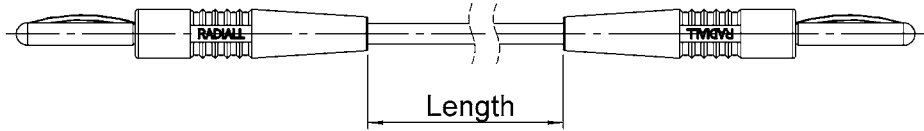

Radiall Patch Cord Series includes:

- **BM/BM:** Molded extension patch cords
- **BDM/BDM:** Molded stackable patch cords
- **PTM/BM:** Molded test probe patch cords
- **Patch cords made-to-order**

EXTENSION PATCH CORDS (BM/BM)

Cable type: PVC, 1mm² conductor, 3.5mm insulation



R948 0xx 000

PATCH CORDS LENGTH:

- 0:** 20cm
- 4:** 50cm
- 5:** 100cm
- 6:** 150cm
- 7:** 200cm

COLOR:

- 0:** Black
- 1:** Red
- 2:** Green
- 3:** Blue

STACKABLE PATCH CORDS (BDM/BDM)

Cable type:

- PVC, 1mm² conductor, 3.5mm insulation
- PVC, 2mm² conductor, insulation
- Silicone, 2.5mm² conductor, 4mm insulation



R948 1xx 0xx

PATCH CORDS LENGTH:

- 3:** 25cm
- 4:** 50cm
- 5:** 100cm
- 6:** 150cm
- 7:** 200cm

COLOR:

- 0:** Black
- 1:** Red
- 2:** Green
- 3:** Blue
- 4:** Yellow

CABLE TYPE:

- 00:** PVC 1mm² 3.5mm
- 02:** PVC 2mm² 3.5mm
- 29:** Silicone 2.5mm² 4mm

Patch cords

TEST PROBE PATCH CORDS (PTM/BM)

Cable types: PVC, 1mm², 3.5mm insulation



Part number	Color	Cord Length
R948 250 000	Black	100cm
R948 251 000	Red	100cm

MADE-TO-ORDER PATCH CORDS

The series comprises the following extremities: BM, BDM, DM. Choices include connector style, cable type, color, and cable length.

HOW TO ORDER

CONNECTOR 1	CABLE TYPE	LENGTH	CONNECTOR 2
<p>BM type</p> <p>R949 000 / Black R949 001 / Red R949 003 / Blue</p> <p>BDM type</p> <p>R949 100 / Black R949 101 / Red</p> <p>DM type</p> <p>R949 500 / Black R949 501 / Red</p> <p>PVC 1mm² cross section: C 290 11x x=0: Black, 1: Red, 2: Green, 3: Blue, 4: Yellow</p> <p>PVC 2mm² cross section: C 290 10x x=0: Black, 1: Red, 2: Green, 3: Blue, 4: Yellow</p> <p>xxx cm: over cable length in centimeter</p>			

BM type
R949 000 / Black
R949 001 / Red
R949 003 / Blue

BDM type
R949 100 / Black
R949 101 / Red

DM type
R949 500 / Black
R949 501 / Red

EXAMPLE TO ORDER:
1 black BDSR plug / green PVC 1mm² with 80cm / 1 Red BDM plug.
Part number: R949 100 / C290 012-80cm / R949101

For free end: please write the word "free"

Accessories

FEMALE / FEMALE ADAPTERS

These adapters allow for the connection between two standard patch cords with BM extremities.

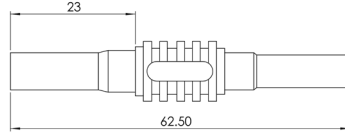

Part number	Color
R941 960 600	Black
R941 961 600	Red

TEST CLIPS

Figure	Description	Part number	Color	Series
	With sliding hook	R999 700 600	Black	4mm safety series
		R999 701 600	Red	
	With alligator test clip	R999 710 600	Black	
		R999 711 600	Red	
	With flexible steel rod test clip	R999 720 600	Black	
		R999 721 600	Red	
	Safety test probe	R941 850 600	Black	4mm standard series
		R941 851 600	Red	
	Safety test probe	R941 850 000	Black	
		R941 851 000	Red	

Introduction

Radiall's high-quality and reliable 2mm Series are designed for high-density test and measurement applications. This series includes a wide range of plugs, sockets, patch cords, test accessories, multiway connectors, short-circuit link, and other configurations.

- Plugs
- Sockets
- Patch cords
- PCB test points
- 20-way fixed connector
- Short circuit links
- Contact block and ribbon patch cords
- Accessories



20-WAY FIXED CONNECTORS



These connectors contain twenty 2mm sockets molded into a low-profile housing. The tight pitch between sockets makes them particularly suitable for use in circuit breakers and test batteries.

ADVANTAGES:

- Quick assembly time with single mounting operation for multi-connections
- Space savings
- Simplified panel piercing
- Orientation of solder shafts



Has the potential to be able to remove the cable harness without disconnecting each socket.

SHORT-CIRCUIT U LINKS



The short-circuit U link is a complementary component to the 20-way fixed connector and can be used to make shunts. It is fitted with a rear-mounted 2mm socket.

Introduction

2mm CONTACT BLOCKS AND RIBBON PATCH CORDS SERIES

This series includes: contact blocks and ribbon patch cords.

Dimensions of contact outlets and projections.

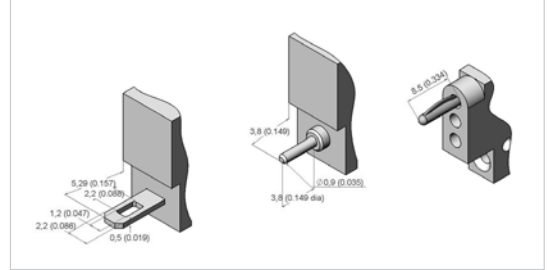
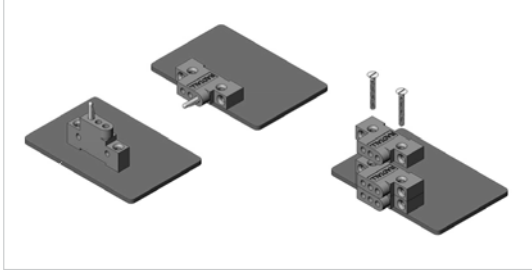

RIBBON PATCH CORDS

The contact blocks can mate with ribbon patch cords, which have:

- Excellent contact
- Sturdy construction
- Contact polarization options
- Low bulk
- High retention

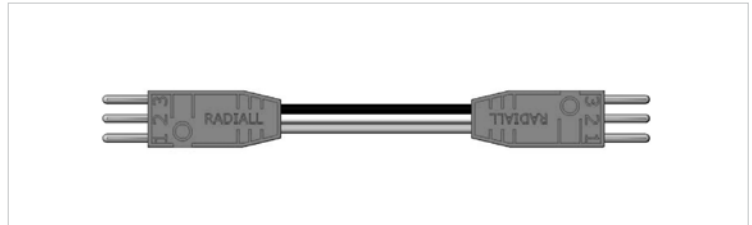

They can be used for several field applications such as: electronics, laboratories, education and telecommunications, etc.

ACCESSORIES PCB TEST SOCKET

Test sockets simplify testing and maintenance of equipment where direct contact with components should be avoided.

- **Test Socket entrax 10.16mm:** This model, with the particular disposition of the pins, allows the unmobilization on the circuit board. This version is particularly adapted for a wave soldering operation.
- **Test Socket entrax 5.08mm:** This test socket is made up of a joined spiral spring with a nickel over plated protection.

ACCESSORIES TEST PROBE

An extra thin probe allows contact through coatings and some insulations. It can also be used for PCB measurements. They are fitted with a rear-mounted 2mm socket and can be used with BLM and BLDM patch cords.

Characteristics

	Plugs	Sockets	Patch Cords
--	-------	---------	-------------

ELECTRICAL CHARACTERISTICS

Current rating, max.	10A (@ 20 °C)	PVC cable 0.3mm ² section	5A (@ 20 °C)
Dielectric withstanding voltage	1500 Vrms @ 50Hz		
Operating voltage	250 Vrms @ 50Hz		
Insulation resistance, min.	5000 MΩ		
Contact resistance, max.	1mΩ		

MECHANICAL CHARACTERISTICS

Mechanical, durability, min.	10,000 matings
Average insertion force	14N

ENVIRONMENTAL CHARACTERISTICS

Temperature range	Uninsulated -65 °C / +155 °C Insulated models -60 °C / +100 °C	-40 °C / +70 °C
-------------------	---	-----------------

MATERIALS

Insulation	Thermoplastic
Contacts	Nickel or tin plated Copper alloy/brass

ELECTRICAL CHARACTERISTICS

	20-way Fixed Connector	Short-Circuit U Links
Current rating max	7A (@20 °C)	
Dielectric withstanding voltage	2000 Vrms 50Hz	
Operating voltage	500 Vrms 50Hz	
Insulation resistance	5000 MΩ	

MECHANICAL CHARACTERISTICS

Mechanical endurance	10,000 matings
----------------------	----------------

ENVIRONMENTAL CHARACTERISTICS

Temperature range	-40 °C/+125 °C	-40 °C/+70 °C
-------------------	----------------	---------------

MATERIAL

Insulation	Self-extinguishable PBT UL 94V0	PVC
Contacts	Brass with gold plating	Brass/Bronze

Characteristics

CONTACT BLOCKS & RIBBON PATCH CORDS

ELECTRICAL CHARACTERISTICS

Current rating, max. • Contact blocks • Ribbon patch cords	7A (@ 20°C) 5A (@ 20°C)
Dielectric withstanding voltage	1500 Vrms @ 50Hz
Operating voltage	250 Vrms @ 50Hz
Insulation resistance (insulated models)	5000 MΩ
Contact resistance	1mΩ

MECHANICAL CHARACTERISTICS

Endurance	>10,000 matings
-----------	-----------------

ENVIRONMENTAL CHARACTERISTICS

Temperature range • Contact blocks • Ribbon patch cords	-65°C / +120°C -40°C / +85°C
---	---------------------------------

MATERIALS

Insulation	Thermoplastic
Body	Nickel or tin plated (solder connection) Copper alloy / brass

ACCESSORIES

ELECTRICAL CHARACTERISTICS

	PCB Test Sockets	Test Probe
Dielectric withstand voltage • Extra 10.16 model • Other models	1500 Vrms 50Hz 1000 V	1000 Vrms
Operating voltage	250 Vrms 50Hz	250 Vrms 50Hz

MECHANICAL

Insulation resistance	10,000MΩ	5000MΩ
-----------------------	----------	--------

ENVIRONMENTAL

Operating temperature	-40°C / +100°C	-25°C / +70°C
-----------------------	----------------	---------------

Packaging

Plugs	100 pieces (except BDR-2=10 pieces)
PCB test sockets	100 pieces
Patch cords	10 pieces
20-way fixed connector	1 piece
Short-circuit u links	100 pieces
PCB test sockets	100 pieces
Test probe	10 pieces
Contact blocks	50 pieces
Ribbon patch cords	10 pieces

Plugs

UNINSULATED BANANA

Figure	Part number	Description	Panel drilling
	R921 019 000	Solder or crimp Strip length: 4mm Crimp tool: Buchanan R612 548 000 Positioner Radiall R282 982 000 Cable: AWG 20, 22, 24	
	R921 029 000	Threaded Rear length 4mm	
	R921 119 000	Nut-tin-plated solder Strip length: 4mm Cable: AWG 20	P03
	R921 149 000	Male-female adapter with nut	P03

INSULATED BANANA PLUGS

Figure	Part number	Color	Description	Panel drilling
	R921 330 000	Black	Tin-plated solder Cable: AWG 20	
	R921 331 000	Red		
	R921 332 000	Green		
	R921 333 000	Blue		
	R921 334 000	Yellow		
	R921 336 000	White		
	R921 461 000	Red	Stackable plug with quick grip clamp 2mm rear socket	

Sockets

UNINSULATED BANANA SOCKETS

Figure	Part number	Description	Panel drilling
	R921 609 000	Tin-plated solder Panel mount: M3.5 x 0.35 thread Strip length: 4mm Cable: AWG 20	P04
	R921 629 000	Tin-plated solder Panel mount: M4 x 0.5 thread Strip length: 4mm Cable: AWG 20	P03

INSULATED BANANA SOCKETS

Figure	Part number	Color	Description	Panel drilling
	R921 920 000	Black	Machined panel-mount socket Tin-plated solder termination Strip length: 4mm Cable: AWG 20	P02
	R921 921 000	Red		
	R921 922 000	Green		
	R921 923 000	Blue		
	R921 924 000	Yellow		
	R921 926 000	White		
	R921 930 000	Black	Stamped panel-mount socket Tin-plated solder termination Strip length: 4mm AWG 20 wire	P02
	R921 931 000	Red		
	R921 932 000	Green		
	R921 933 000	Blue		
	R921 934 000	Yellow		
	R921 936 000	White		

Patch cords

Except where specified, all patch cords lengths are defined by the length of the cable without connectors or strain relief.

Radiall Patch Cord Series includes:

- **BLM**: Molded miniature extension patch cords
- **BLDM**: Molded miniature stackable patch cords
- **Patch cords made-to-order**

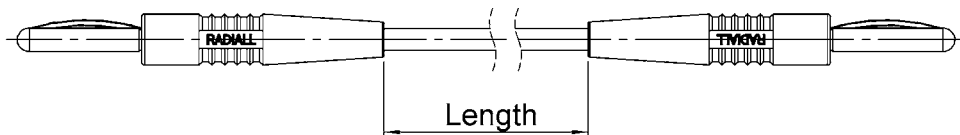

Each plug is soldered onto the cable in order to assure an excellent electrical connection with very stable transfer resistance.

Plugs

MOLDED EXTENSION (BLM)

Cable: PVC cable 0.3 mm²



R928 0xx 000

MOLDED STACKABLE (BLDM)

Cable: PVC cable 0.3 mm²



R928 1xx 000

PATCH CORDS LENGTH:
1: 10cm
5: 100cm

COLOR:
0: Black
1: Red
3: Blue

PATCH CORDS LENGTH:
1: 10cm
2: 20cm
4: 50cm
5: 100cm

COLOR:
0: Black
1: Red
2: Green
3: Blue
4: Yellow

MADE-TO-ORDER PATCH CORDS

Customized patch cords using BLM, BLDM, or DLM plugs can be made-to-order to your specifications. Choices include connector style, cable type, color, and cable length. Packaging: 10 identical patch cords.

HOW TO ORDER

	CONNECTOR 1	CABLE TYPE	LENGTH	CONNECTOR 2
BM type R929 000 / Black R929 001 / Red				
BDLM type R929 100 / Black R929 101 / Red				
DLM type R929 500 / Black R929 501 / Red				
PVC section 0.3mm²: C 290 00x x=0: Black, 1: Red, 2: Green, 3: Blue, 4: Yellow				
xxx cm: over cable length in centimeter				

BM type
R929 000 / Black
R929 001 / Red

BDM type
R929 100 / Black
R929 101 / Red

DM type
R929 500 / Black
R929 501 / Red

EXAMPLE TO ORDER:

1 black BLM extremity / red PVC cable length 40cm / 1 red BLM plug.
 Part number: R929 000 / C290 001-40cm / R929501

For free end: please write the word "free"

20-way fixed connectors

12mm CONTACT PITCH

Figure	Part number	Color	Termination
	R929 991 000	Black	Solder cup
	R929 991 001	Red	
	R929 991 002	Green	
	R929 991 003	Blue	
	R929 991 004	Yellow	
	R929 992 000	Blue	Pin

6mm CONTACT PITCH

Figure	Part number	Color	Termination
	R929 993 000	Black	Solder cup
	R929 993 001	Red	
	R929 993 002	Green	
	R929 993 003	Blue	
	R929 993 004	Yellow	
	R929 994 003	Black	Pin

Short-Circuit U Link

12mm CONTACT PITCH

Figure	Part number	Color
	R644 543 000	Black
	R644 543 001	Red
	R644 543 002	Green
	R644 543 003	Blue
	R644 543 004	Yellow

6mm CONTACT PITCH

Figure	Part number	Color
	R644 543 020	Black
	R644 543 021	Red
	R644 543 022	Green
	R644 543 023	Blue
	R644 543 024	Yellow

Contact blocks

The contact blocks are available for different types of connections:

- Wire soldering
- Straight pins for PCB
- Elbow pins for PCB (contact your Radiall sales representative)
- Wrapping pins (contact your Radiall sales representative)

MALE CONTACT BLOCKS

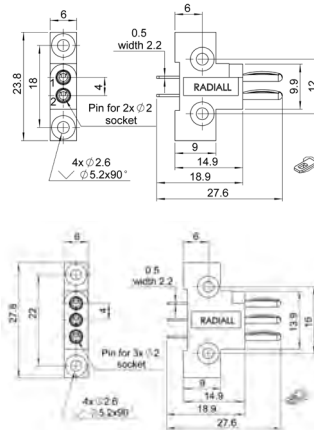

Part number	Note
R644 020 000	Tin-plated solder cup
R644 030 000	

FEMALE CONTACT BLOCKS

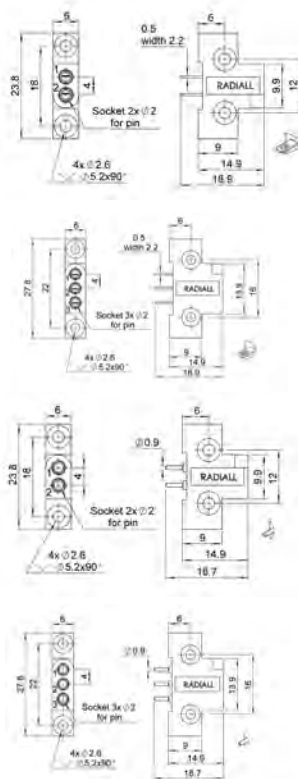

Part number	Note
R644 120 000	Tin-plated solder cup
R644 130 000	
R644 121 000	PCB Pins
R644 131 000	

Ribbon patch cords



The contact blocks are available for different types of connections:

MALE-MALE RIBBON PATCH CORDS 100cm LENGTHS

Figure	Part number	Destination	Number of contact
	R644 823 000	ML 2 MM	2
	R644 833 000	ML 3 MM	3

Accessories

TEST SOCKETS AND TEST PROBE

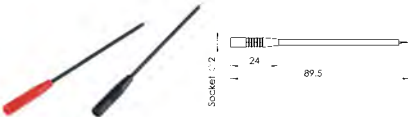
Figure	Part number	Color	Description
	R921 910 000	Black	Test socket entrax 10.16mm
	R921 911 000	Red	
	R921 912 000	Green	
	R921 913 000	Blue	
	R921 914 000	Yellow	
	R921 914 000	White	
	R921 820 070	Black	Test socket entrax 5.08mm
	R921 820 071	Red	
	R921 820 072	Green	
	R921 820 073	Blue	
	R921 820 074	Yellow	
	R921 820 076	White	
	R921 850 000	Black	Test probe
	R921 851 000	Red	

Introduction

The connection may be attached to a coaxial line. You will find at the end of the catalog the adapters which allow connecting between 2mm and 4mm or between BNC coaxial connectors with banana plugs for both 2mm and 4mm connectors.

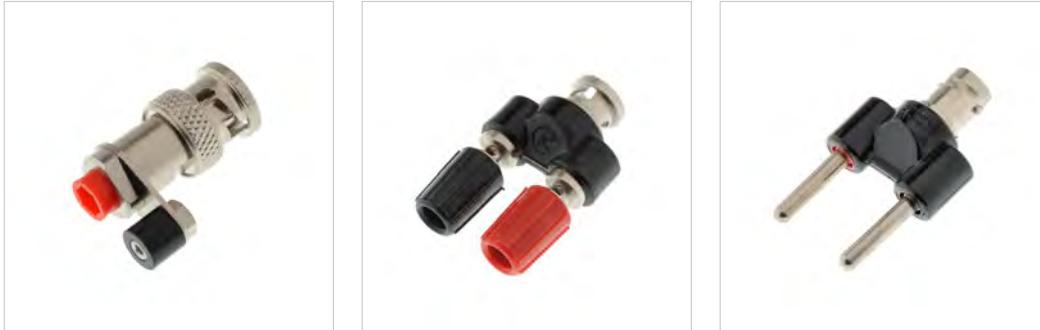

Characteristics

	2mm / 4mm Adapter	BNC / 2mm Adapter	BNC / 4mm Adapter	Adapter Patch Cords
--	-------------------	-------------------	-------------------	---------------------

ELECTRICAL CHARACTERISTICS

Current rating, max.	10A (@ 20°C)			5A (@ 20°C)
Dielectric withstanding voltage	1500 Vrms @ 50Hz		Two: 2500 Vrms @50Hz One-way: 750 Vrms @50Hz	1500 Vrms @ 50Hz
Operating voltage	250 Vrms @ 50Hz			250 Vrms @ 50Hz
Insulation resistance (insulated models)	5000 MΩ		Two: 5000 MΩ One-way: 5000 MΩ	5000MΩ

ENVIRONMENTAL CHARACTERISTICS

Temperature range	-40°C / +70°C	-40°C / +100°C	-40°C / +70°C
-------------------	---------------	----------------	---------------

MATERIALS

Insulator (banana plug/socket side)	Thermoplastic
Electrical contacts	Nickel or tin plated Copper alloy/brass

Packaging

Description	Packaging
2mm / 4mm	100 pieces
BNC / 2mm	1 piece
BNC / 2mm	1 piece
Patch cords	10 pieces

Adapters

2MM PIN TO 4MM SOCKET ADAPTERS

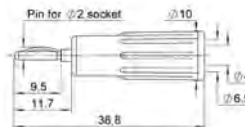
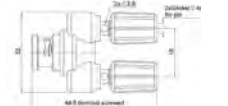



Figure	Part number	Color	Note
 	R921 390 000	Black	2mm male - 4mm female adapter
	R921 391 000	Red	

2MM TO BNC ADAPTERS

Figure	Part number	Color	Note
 	R191 450 000	Black	Packaging individually

4MM TO BNC ADAPTERS

These adaptors are designed to uncouple electric signals from input and output terminals of a measuring device fitted with male or female BNC fixed connectors.

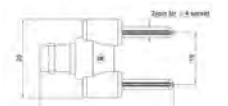

Figure	Part number	Note
 	R191 453 000	BNC: male Banana: two 4mm sockets
 	R191 454 000	BNC: male Banana: one 4mm socket
 	R191 455 000	BNC: female Banana: two 4mm plugs

Patch cords

BANANA ADAPTER PATCH CORDS

Patch cords are designed to provide continuity between two pieces of equipment or create patch cords with 2mm interfaces on one end and 4mm interface on the other.

Cable Type: 0.3 mm², PVC

Figure	Part number	Color	Configuration
	R999 251 000	Red	BLM / BM 100cm length
	R999 350 000	Black	BLDM / BDM 100cm length
	R999 351 000	Red	
	R999 352 000	Green	
	R999 353 000	Blue	
	R999 354 000	Yellow	
	R999 520 000	Black	BLM / DM 20cm length
	R999 521 000	Red	

COAXIAL PATCH CORDS/4mm BANANA PLUG

BCX COAXIAL PATCH CORDS

The BCX coaxial cords are normally connected to the terminals of measuring devices in order to uncouple the central core from the braid of a coaxial cable. The BCX plug is non-removable. The cable core is soldered to the center contact and the braid is soldered to the socket.

Figure	Part number	Color	Configuration
	R948 450 000	Black	Length: 100cm (with connectors)

Panel drilling

P01

PANEL CUT OUT

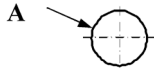

mm		
	Maxi	mini
A	6.2	6.1

P02

PANEL CUT OUT

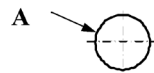

mm		
	Maxi	mini
A	5.2	5.1

P03

PANEL CUT OUT



mm		
	Maxi	mini
A	4.2	4.1

P04

PANEL CUT OUT

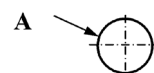

mm		
	Maxi	mini
A	3.7	3.6

P05

PANEL CUT OUT

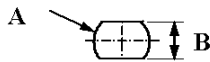

mm		
	Maxi	mini
A	12.2	12.1
B	11.2	11.1

P06

PANEL CUT OUT

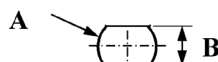

mm		
	Maxi	mini
A	8.2	8.1
B	7.2	7.1

NOTE



Our Most Important Connection is with You.™

NOTE



SECTION 21

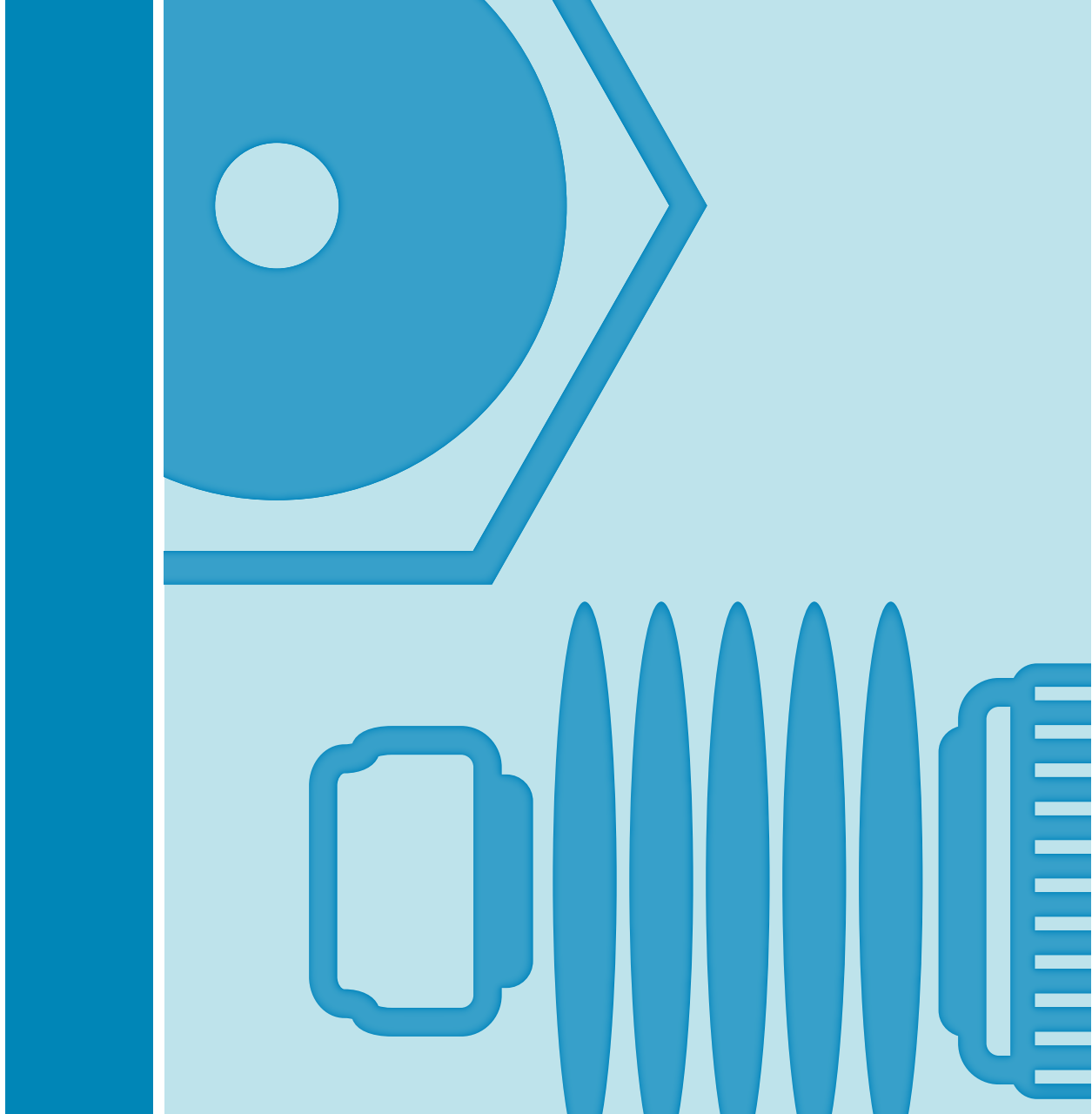

INDEX



Radiall part numbers

ACCESSORIES

99762..... 17-19
 240 92 671 17-22
 240 92 672 17-22
 240 92 673 17-22
 240 92 674 17-22
 240 92 675 17-22
 240 92 676 17-22
 240 92 677 17-22
 240 92 678 17-22
 240 92 682 17-22
 240 92 684 17-22
 240 94 681 17-22
 241 92 040 17-22
 A240 92 010 17-22

SMC

1001-1551-002 6-26
 1001-1551-003 6-26
 1001-1551-005 6-26
 1001-1551-019 6-26
 1001-1571-002 6-26
 1001-1571-003 6-26
 1001-1571-005 6-26
 1001-1571-009 6-26
 1001-1571-010 6-26
 1001-1571-019 6-26
 1001-7551-002 6-26
 1001-7551-003 6-26
 1001-7551-005 6-26
 1001-7551-019 6-26
 1001-7571-002 6-26
 1001-7571-003 6-26
 1001-7571-005 6-26
 1001-7571-009 6-26
 1001-7571-010 6-26
 1001-7571-019 6-26
 1002-1541-009 6-25
 1002-1541-010 6-25
 1002-1551-002 6-25
 1002-1551-003 6-25

1002-1551-005 6-25
 1002-1551-019 6-25
 1002-1571-002 6-25
 1002-1571-003 6-25
 1002-1571-005 6-25
 1002-1571-019 6-25
 1002-7541-009 6-25
 1002-7541-010 6-25
 1002-7551-002 6-25
 1002-7551-003 6-25
 1002-7551-005 6-25
 1002-7551-019 6-25
 1002-7571-002 6-25
 1002-7571-003 6-25
 1002-7571-005 6-25
 1002-7571-019 6-25
 1003-1541-009 6-27
 1003-1541-010 6-27
 1003-1551-002 6-26
 1003-1551-003 6-26
 1003-1551-005 6-26
 1003-1551-019 6-27
 1003-1571-002 6-26
 1003-1571-003 6-26
 1003-1571-005 6-26
 1003-1571-019 6-27
 1003-7541-009 6-27
 1003-7541-010 6-27
 1003-7551-002 6-26
 1003-7551-003 6-26
 1003-7551-005 6-26
 1003-7551-019 6-27
 1003-7571-002 6-26
 1003-7571-003 6-26
 1003-7571-005 6-26
 1003-7571-019 6-27
 1004-1511-000 6-27
 1004-7511-000 6-27
 1005-1541-009 6-25
 1005-1541-010 6-25
 1005-1551-002 6-25
 1005-1551-003 6-25

1005-1551-005 6-25
 1005-1551-019 6-25
 1005-7541-009 6-25
 1005-7541-010 6-25
 1005-7551-002 6-25
 1005-7551-003 6-25
 1005-7551-005 6-25
 1005-7551-019 6-25
 1006-1541-009 6-27
 1006-1541-010 6-27
 1006-1551-002 6-26
 1006-1551-003 6-26
 1006-1551-005 6-26
 1006-1551-019 6-27
 1006-7541-009 6-27
 1006-7541-010 6-27
 1006-7551-002 6-26
 1006-7551-003 6-26
 1006-7551-005 6-26
 1006-7551-019 6-27
 1009-1511-000 6-28
 1009-1511-005 6-28
 1009-7511-000 6-28
 1009-7511-005 6-28
 1010-1511-000 6-28
 1010-1511-001 6-28
 1010-7511-000 6-28
 1010-7511-001 6-28
 1012-1511-000 6-27
 1012-7511-000 6-27
 1017-1511-000 6-27
 1017-7511-000 6-27
 1019-1511-000 6-27
 1019-7511-000 6-27
 1036-1511-051 19-6
 1105-1521-002 6-25
 1105-1521-003 6-25
 1105-1521-005 6-25
 1105-1521-019 6-25
 1105-7521-002 6-25
 1105-7521-003 6-25
 1105-7521-005 6-25

1105-7521-019 6-25
 1106-1521-002 6-26
 1106-1521-003 6-26
 1106-1521-005 6-26
 1106-1521-019 6-27
 1106-7521-002 6-26
 1106-7521-003 6-26
 1106-7521-005 6-26
 1106-7521-019 6-27
 1109-1511-000 6-28
 1109-7511-000 6-28
 1110-1511-000 6-28
 1110-7511-000 6-28
 1484-1511-000 6-27
 1484-7511-000 6-27
 1486-1511-000 6-27
 1486-7511-000 6-27
 1488-1511-000 6-27
 1488-7511-000 6-27
 1490-1511-000 6-27
 1490-7511-000 6-27

SMB

001-1571-002 6-12
 2001-1571-003 6-12
 2001-1571-005 6-12
 2001-1571-019 6-12
 2001-7571-002 6-12
 2001-7571-003 6-12
 2001-7571-019 6-12
 2002-1541-009 6-9
 2002-1541-010 6-9
 2002-1551-002 6-9
 2002-1551-003 6-9
 2002-1551-005 6-9
 2002-1551-019 6-9
 2002-1571-002 6-8
 2002-1571-003 6-8
 2002-1571-005 6-8
 2002-1571-019 6-8
 2002-7541-009 6-9
 2002-7541-010 6-9

Radiall part numbers

2002-7551-002	6-9	2010-7511-002	6-16
2002-7551-003	6-9	2012-1511-000	6-15
2002-7551-019	6-9	2012-7511-000	6-15
2002-7571-002	6-8	2014-1511-000	6-14
2002-7571-003	6-8	2014-7511-000	6-14
2002-7571-005	6-8	2019-1511-000	6-14
2002-7571-019	6-8	2019-7511-000	6-14
2003-1541-009	6-13	2025-1511-000	6-15
2003-1541-010	6-13	2025-7511-000	6-15
2003-1551-002	6-13	2041-1541-009	6-11
2003-1551-003	6-13	2041-1541-010	6-11
2003-1551-005	6-13	2041-1551-002	6-11
2003-1551-019	6-13	2041-1551-003	6-11
2003-1571-002	6-12	2041-7541-010	6-11
2003-1571-003	6-12	2041-7551-003	6-11
2003-1571-005	6-12	2105-1521-002	6-10
2003-1571-019	6-12	2105-1521-003	6-10
2003-7541-010	6-13	2105-1521-003	6-10
2003-7551-002	6-13	2105-1521-019	6-10
2003-7551-003	6-13	2105-7521-002	6-10
2003-7571-002	6-12	2105-7521-003	6-10
2003-7571-003	6-12	2105-7521-005	6-10
2003-7571-005	6-12	2105-7521-019	6-10
2003-7571-019	6-12	2106-1521-002	6-13
2004-1511-000	6-14	2106-1521-003	6-13
2004-7511-000	6-14	2106-1521-019	6-13
2005-1541-009	6-11	2106-7521-002	6-13
2005-1541-010	6-11	2106-7521-003	6-13
2005-1551-002	6-11	2106-7521-019	6-13
2005-1551-003	6-11	2109-1511-000	6-15
2005-1551-019	6-11	2109-7511-000	6-15
2005-7541-009	6-11	2141-1521-002	6-10
2005-7541-010	6-11	2141-1521-003	6-10
2005-7551-002	6-11	2141-1521-019	6-10
2005-7551-003	6-11	2141-7521-003	6-10
2009-1511-000	6-15	2141-7521-019	6-10
2009-1511-050	6-15	2484-1511-000	6-14
2009-7511-000	6-15	2486-1511-000	6-14
2009-7511-050	6-15	2486-7511-000	6-14
2010-1511-000	6-16		
2010-1511-002	6-16		
2010-7511-000	6-16		

N

4000-1563-009	10-7
4000-1563-010	10-7
4000-7071-019	11-11
4501-7051-003	11-15
4501-9543-009	10-7, 11-16
4502-7041-009	11-16
4502-7041-010	11-16
4502-7051-003	11-15

ADAPTERS

5207-1501-000	6-17, 16-10
5207-7501-000	6-17
5208-1501-000	6-17, 16-10
5208-7501-000	6-17
5208-7501-000	6-17, 16-10
5213-7501-000	6-17
5215-1501-000	6-17, 16-10
5215-7501-000	6-17
5216-1501-000	6-17, 16-10
5216-7501-000	6-17
5222-1501-000	6-17, 16-10
5222-7501-000	6-17
5402-1501-000	16-6
5403-1501-000	16-6
5404-1501-000	16-6
5405-1501-000	16-6
5510-1501-000	16-6
5512-7501-000	16-6
5822-1501-000	6-28
5909-1103-000	7-35
5909-9103-000	7-35
5916-1103-603	7-35
5916-9103-603	7-35

5917-1103-000	7-35
5917-9103-000	7-35
5918-1103-000	7-35
5918-9103-000	7-35
5919-1503-000	7-35
5919-1503-001	7-35
5919-1503-003	7-35
5919-9503-000	7-35
5919-9503-001	7-35
5919-9503-003	7-35
5938-1503-000	16-7
5945-9503-000	16-7
5964-9513-001.2-10,16-7	
5965-9513-000.2-10,16-7	

TNC

6001-7041-010	11-30
6001-7051-003	11-30
6002-7051-002	11-30
6002-7051-003	11-30
6002-7551-106	11-30
6002-7551-202	11-30
6002-7551-219	11-30

BNC

6500-7071-046	9-25
6501-6571-103	9-19
6501-7551-219	9-19

SSMC

7001-1541-010	12-13
7002-1542-010	12-13
7002-1542-011	12-13
7002-1571-002	12-13
7002-1571-003	12-13
7002-1571-019	12-13
7002-1572-002	12-13
7002-1572-003	12-13
7002-1572-019	12-13
7003-1542-011	12-14
7003-1572-002	12-14

Radiall part numbers

7003-1572-003 12-14	7210-1511-040 12-11	9001-1023-002 7-18	9001-9573-005 7-18
7009-1511-000 12-14	7210-1511-050 12-11	9001-1023-003 7-18	9001-9573-006 7-18
7009-1511-004 12-14	7219-1511-000 12-9	9001-1023-005 7-18	9001-9573-019 7-18
7009-1511-050 12-14	7222-1501-600 12-11,	9001-1023-006 7-18	9002-1023-001 7-22
7010-1511-000 12-14	16-10	9001-1023-019 7-18	9002-1023-002 7-22
7010-1511-041 12-14	7225-1512-000 12-10	9001-1033-001 7-18	9002-1023-003 7-22
7010-1511-050 12-14	7225-1512-004 12-10	9001-1033-002 7-18	9002-1023-005 7-22
7029-1511-031 12-14	7225-1512-012 12-10	9001-1033-003 7-18	9002-1023-006 7-22
7029-1513-004 12-14	7225-1512-040 12-10	9001-1033-005 7-18	9002-1023-019 7-22
7029-1513-005 12-14	7225-1512-050 12-10	9001-1033-006 7-18	9002-1033-002 7-22
7042-1511-040 12-14	7225-1512-050 12-10	9001-1033-019 7-18	9002-1033-003 7-22
7101-1571-002 12-13	7242-1511-000 12-11	9001-1553-001 7-18	9002-1033-005 7-22
7105-1521-002 12-13	7242-1511-012 12-11	9001-1553-002 7-18	9002-1033-006 7-22
7105-1521-003 12-13	7242-1511-050 12-11	9001-1553-003 7-18	9002-1033-019 7-22
7105-1521-019 12-13	7405-1521-002 12-8	9001-1553-005 7-18	9002-9023-002 7-22
7105-1561-010 12-13	7405-1521-003 12-8	9001-1553-006 7-18	9002-9023-003 7-22
7105-1561-011 12-13	7405-1521-005 12-8	9001-1553-019 7-18	9002-9023-005 7-22
7110-1511-000 12-14	7405-1521-019 12-8	9001-1573-001 7-18	9002-9023-006 7-22
7110-1511-050 12-14	7405-1561-010 12-9	9001-1573-002 7-18	9002-9023-019 7-22
7122-1502-000 12-14,	7405-1561-011 12-9	9001-1573-003 7-18	9004-1113-000 7-28
16-10	7405-2521-002 12-8	9001-1573-005 7-18	9004-1213-000 7-28
7145-1521-002 17-21	7406-1521-002 12-9	9001-1573-006 7-18	9004-9113-000 7-28
	7406-1521-003 12-9	9001-1573-019 7-18	9007-9113-000 7-28
	7406-1521-005 12-9	9001-9023-001 7-18	9008-1113-000 7-28
	7410-1511-000 12-10	9001-9023-002 7-18	9008-1213-000 7-28
	7410-1511-012 12-10	9001-9023-003 7-18	9008-9113-000 7-28
	7410-1511-040 12-10	9001-9023-005 7-18	9030-1023-001 7-24
	7410-1511-050 12-10	9001-9023-006 7-18	9030-1023-002 7-24
		9001-9023-019 7-18	9030-1023-003 7-24
		9001-9033-001 7-18	9030-1023-005 7-24
		9001-9033-002 7-18	9030-1023-006 7-24
		9001-9033-003 7-18	9030-1023-019 7-24
		9001-9033-005 7-18	9030-1033-001 7-24
		9001-9033-006 7-18	9030-1033-002 7-24
		9001-9033-019 7-18	9030-1033-003 7-24
		9001-9553-001 7-18	9030-1033-005 7-24
		9001-9553-003 7-18	9030-1033-006 7-24
		9001-9553-005 7-18	9030-1033-019 7-24
		9001-9553-006 7-18	9030-9023-001 7-24
		9001-9553-019 7-18	9030-9023-002 7-24
		9001-9573-001 7-18	9030-9023-003 7-24
		9001-9573-003 7-18	9030-9023-005 7-24

SSMB

7202-1542-010 12-8
7202-1542-011 12-8
7202-1572-002 12-8
7202-1572-003 12-8
7202-1572-019 12-8
7203-1541-010 12-9
7203-1541-011 12-9
7204-1511-000 12-9
7209-1511-000 12-10
7209-1511-011 12-10
7209-1511-012 12-10
7209-1511-015 12-10
7209-1511-040 12-10
7209-1511-050 12-10
7209-1511-050 12-11
7210-1511-012 12-11
7210-1511-015 12-11
7210-1511-019 12-11

ACCESSORIES

8045-1541-010 17-21
8045-1551-003 17-21
8145-1521-002 17-21
8145-1521-002 17-21
8145-1521-002 17-21

MCX

8955-1521-003 1-21

SMA

9001-1023-001 7-18

Radiall part numbers

9030-9023-006 7-24	9079-9513-001 7-33	9144-9513-000 7-33	9401-7583-109 7-19
9030-9023-019 7-24	9080-9513-000 7-33	9180-9513-000 7-33	9402-1083-009 7-23
9031-1023-001 7-22	9102-1573-001 7-22	9180-9513-001 7-33	9402-1083-010 7-23
9031-1023-002 7-22	9102-1573-002 7-22	920-55 7-33	9402-1583-009 7-23
9031-1023-003 7-22	9102-1573-003 7-22	920-56 7-33	9402-1583-010 7-23
9031-1023-005 7-22	9102-1573-005 7-22	920-82 7-33	9402-7083-009 7-23
9031-1023-006 7-22	9102-1573-006 7-22	9201-9573-002 7-18	9402-7083-010 7-23
9031-1023-019 7-22	9102-1573-019 7-22	9230-1553-001 7-24	9402-7583-009 7-23
9031-1033-001 7-22	9102-9573-001 7-22	9230-1553-002 7-24	9402-7583-010 7-23
9031-1033-002 7-22	9102-9573-002 7-22	9230-1553-003 7-24	9404-1113-000 7-27
9031-1033-003 7-22	9102-9573-003 7-22	9230-1553-005 7-24	9407-1113-000 7-26
9031-1033-005 7-22	9102-9573-005 7-22	9230-1553-006 7-24	9407-9113-000 7-26
9031-1033-006 7-22	9102-9573-006 7-22	9230-1553-019 7-24	9408-1113-000 7-26
9031-1033-019 7-22	9102-9573-019 7-22	9230-9553-001 7-24	9408-1113-002 7-26
9031-9023-001 7-22	9124-1513-000 7-30	9230-9553-002 7-24	9408-9113-000 7-26
9031-9023-002 7-22	9124-9513-000 7-30	9230-9553-003 7-24	9408-9113-002 7-26
9031-9023-003 7-22	9126-1513-000 7-30	9230-9553-005 7-24	9412-1113-000 7-27
9031-9023-005 7-22	9126-9513-000 7-30	9230-9553-006 7-24	9412-9113-000 7-27
9031-9023-006 7-22	9130-1573-001 7-24	9230-9553-019 7-24	9422-1113-000 7-27
9031-9023-019 7-22	9130-1573-002 7-24	9243-1553-001 7-20	9422-9113-000 7-27
9043-1523-001 7-20	9130-1573-003 7-24	9243-1553-002 7-20	9424-1513-000 7-26
9043-1523-002 7-20	9130-1573-005 7-24	9243-1553-003 7-20	9424-9513-000 7-26
9043-1523-003 7-20	9130-1573-006 7-24	9243-1553-005 7-20	9425-1513-000 7-26
9043-1523-005 7-20	9130-1573-019 7-24	9243-1553-006 7-20	9425-9513-000 7-26
9043-1523-006 7-20	9130-9573-001 7-24	9243-1553-019 7-20	9431-1083-009 7-23
9043-1523-019 7-20	9130-9573-002 7-24	9243-9553-001 7-20	9431-1083-010 7-23
9043-1533-001 7-20	9130-9573-003 7-24	9243-9553-002 7-20	9431-1583-009 7-23
9043-1533-002 7-20	9130-9573-005 7-24	9243-9553-003 7-20	9431-1583-010 7-23
9043-1533-003 7-20	9130-9573-006 7-24	9243-9553-005 7-20	9431-7083-009 7-23
9043-1533-005 7-20	9130-9573-019 7-24	9243-9553-006 7-20	9431-7083-010 7-23
9043-1533-006 7-20	9131-1573-001 7-22	9243-9553-019 7-20	9431-7583-009 7-23
9043-1533-019 7-20	9131-1573-002 7-22	9301-1063-009 7-19	9431-7583-010 7-23
9043-9523-001 7-20	9131-1573-003 7-22	9301-7063-009 7-19	9432-1113-000 7-27
9043-9523-002 7-20	9131-1573-005 7-22	9401-1083-010 7-19	9432-9113-000 7-27
9043-9523-003 7-20	9131-1573-006 7-22	9401-1083-109 7-19	9441-1083-009 7-23
9043-9523-005 7-20	9131-1573-019 7-22	9401-1083-210 7-19	9441-1083-010 7-23
9043-9523-006 7-20	9131-9573-001 7-22	9401-1583-010 7-19	9441-1583-009 7-23
9043-9523-019 7-20	9131-9573-002 7-22	9401-1583-109 7-19	9441-1583-010 7-23
9050-9513-000 7-33	9131-9573-003 7-22	9401-7083-010 7-19	9441-7083-009 7-23
9074-9513-000 7-33	9131-9573-005 7-22	9401-7083-109 7-19	9441-7083-010 7-23
9076-9113-000 7-28	9131-9573-006 7-22	9401-7083-210 7-19	9441-7583-009 7-23
9079-9513-000 7-33	9131-9573-019 7-22	9401-7583-010 7-19	9441-7583-010 7-23

Radiall part numbers

9443-1563-009 7-21	9613-9563-009 7-25	C291 325 290 18-6	C291 999 904 18-6
9443-1563-010 7-21	9613-9563-010 7-25	C291 326 490 18-6	C291 999 905 18-6
9453-1083-009 7-25	9620-9003-151 19-6	C291 327 010.18-6,18-36	
9453-1083-010 7-25	9620-9003-251 19-6	C291 327 020.18-6,18-37	
9453-1583-009 7-25		C291 327 030.18-6,18-38	
9453-1583-010 7-25		C291 327 040.18-6,18-39	
9453-7083-009 7-25	SSMA	C291 327 050.18-6,18-40	
9453-7083-010 7-25	9765-9523-003 12-5	C291 327 060.18-6,18-35	
9453-7583-009 7-25		C291 330 000 18-6	
9453-7583-010 7-25	CABLES	C291 333 039 18-7	UMP / IMP
9476-1113-000 7-27	C290 00x 20-25	C291 351 012 18-6	R107 003 010 14-14
9501-1593-009 7-19	C290 010 20-13	C291 360 000 18-6	R107 009 901 14-145, 16-4
9501-1593-010 7-19	C290 011 20-13	C291 360 093 18-7	R107 009 903 14-15, 16-4
9501-9593-009 7-19	C290 10x 20-17	C291 384 083 18-7	R107 064 070 14-12
9501-9593-010 7-19	C290 110 20-13	C291 491 060 18-6	R107 064 080 14-12
9502-1593-010 7-23	C290 111 20-13	C291 510 000.18-6, 18-8	R107 303 040 14-14
9502-9593-009 7-23	C290 11x 20-17	C291 510 010 18-18	
9502-9593-010 7-23	C291 042 066 18-6	C291 511 007.18-6,18-19	
9530-1593-009 7-25	C291 050 066 18-6	C291 512 020 18-6	MMCX
9530-1593-010 7-25	C291 055 076 18-6	C291 600 000.18-6,18-19	R110 081 020 1-16
9530-9593-009 7-25	C291 140 087.15-24,18-6	C291 600 010.18-6, 18-19	R110 083 120 1-16
9530-9593-010 7-25	C291 145 007 18-6	C291 610 000.18-6,18-20	R110 153 000 1-16
9543-1593-009 7-21	C291 145 017 18-6	C291 844 065 18-7	R110 170 100 1-16
9543-1593-010 7-21	C291 146 087 18-6	C291 844 187 18-7	R110 170 147 15-19
9543-9593-009 7-21	C291 147 060 18-6	C291 850 001 18-7	R110 172 100 1-16
9543-9593-010 7-21	C291 150 000 18-6	C291 850 005 18-7	R110 422 100 1-16
9609-1513-000 7-27	C291 150 010 18-6	C291 851 001 15-24, 18-7	R110 426 000 1-17
9609-9513-000 7-27	C291 170 007 18-6	C291 855 001 18-7	R110 426 107 15-19
9613-1523-001 7-25	C291 170 017 18-6	C291 855 065 18-7	R110 427 810 1-17
9613-1523-002 7-25	C291 170 079 15-24	C291 860 001 18-7	R110 427 820 1-17
9613-1523-003 7-25	C291 171 083 18-6	C291 861 061.5-24, 18-7	R110 434 100 1-16
9613-1523-005 7-25	C291 185 067 18-6	C291 861 066 18-7	R110 434 860 1-16
9613-1523-006 7-25	C291 210 007 18-6	C291 862 005 18-7	R110 665 860 1-17
9613-1523-019 7-25	C291 217 020 18-6	C291 864 065 18-7	R110 704 103.1-17, 16-9
9613-1563-009 7-25	C291 305 000 18-6	C291 864 187 18-7	R110A 170 100 1-16
9613-1563-010 7-25	C291 305 010 18-6	C291 866 378 18-7	R110A 172 100 1-16
9613-9523-001 7-25	C291 320 007 18-6	C291 870 001 18-7	R110A 422 830 1-16
9613-9523-002 7-25	C291 320 180 18-6	C291 874 187 18-7	R110A 426 000 1-17
9613-9523-003 7-25	C291 322 017 18-6	C291 993 170 18-7	R110A 427 830 1-17
9613-9523-005 7-25	C291 324 007 18-6	C291 994 170 18-7	
9613-9523-006 7-25	C291 324 079 15-24	C291 996 170 18-7	SMC
9613-9523-019 7-25	C291 325 270 18-6		R112 003 000 6-25

Radiall part numbers

R112 183 000 6-25	R113 424 020 1-23	R114 413 000 6-14	R121 172 000 12-5
R112 186 000 6-25	R113 424 097 15-20	R114 416 020 6-15	R121 414 000 12-6
R112 205 000 6-26	R113 425 000 1-23	R114 423 000 6-15	R121 464 000 12-6
R112 303 000 6-26	R113 425 097 15-20	R114 424 000 6-15	R121 630 003 12-6
R112 305 000 6-26	R113 426 000 1-23	R114 424 100 6-15	R121 703 000.12-6,16-10
R112 403 000 6-27	R113 426 097 15-20	R114 425 000 6-15	R121 705 000 16-10
R112 426 000 6-28	R113 427 000 1-23	R114 426 000 6-15	R121 705 001 12-6
R112 553 000 6-27	R113 553 000 1-23	R114 426 147 15-22	
R112 554 000 6-27	R113 664 000 1-24	R114 450 000 6-14	QMA
R112 665 000 6-28	R113 665 000 1-24	R114 504 225 6-15	R123 054 000 8-8
R112 670 000 6-27	R113 665 020 1-24	R114 553 000 6-14	R123 055 000 8-8
R112 720 000.6-28,16-10	R113 665 097 15-20	R114 554 000 6-14	R123 071 000.8-8, 18-35
R112 780 000.6-28,16-10	R113 666 000 1-24	R114 603 000 6-14	R123 072 000 8-8
	R113 704 000..1-24, 16-9	R114 664 000 6-16	R123 075 000 8-8

MCX

R113 053 000 1-21
R113 081 000 1-21
R113 081 097 15-19
R113 082 000 1-21
R113 082 097 15-19
R113 083 000 1-21
R113 151 000 1-22
R113 153 000 1-22
R113 161 000 1-22
R113 181 000 1-21
R113 181 097 15-19
R113 182 000 1-21
R113 182 020 1-21
R113 182 097 15-19
R113 183 000 1-21
R113 183 020 1-21
R113 223 000 1-22
R113 240 000 1-22
R113 240 097 15-20
R113 303 000 1-22
R113 306 000 1-22
R113 310 000 1-22
R113 312 000 1-22
R113 402 220 1-23
R113 423 000 1-23
R113 424 000 1-23
R113 424 010 1-23

SMB

R114 003 000 6-9
R114 005 000 6-9
R114 053 000 6-9
R114 073 000 6-8
R114 075 000 6-8
R114 082 000 6-8
R114 082 107 15-21
R114 083 000 6-8
R114 163 000 6-11
R114 163 420 6-11
R114 165 000 6-11
R114 169 000 6-11
R114 182 000 6-10
R114 183 000 6-10
R114 185 000 6-10
R114 186 000 6-10
R114 186 100 6-10
R114 186 197 15-21
R114 187 000 6-10
R114 222 000 6-13
R114 238 000 6-12
R114 303 000 6-13
R114 303 133 6-13
R114 305 000 6-13
R114 313 000 6-12
R114 313 197 15-21

SMB-LOCK

R115 427 000 6-21
R115 556 000 6-20
R115 666 000 6-21
R116 426 000 6-21
R117 082 807 6-20
R117 186 807 6-20

SSMA

R121 053 000 12-5
R121 072 000 12-5
R121 153 000 12-5

QMA

R123 054 000 8-8
R123 055 000 8-8
R123 071 000.8-8, 18-35
R123 072 000 8-8
R123 075 000 8-8
R123 075 200.8-8, 18-36
R123 076 000 8-8
R123 076 310.8-8, 18-38
R123 096 110.8-8, 18-37
R123 141 000 8-11
R123 142 000 8-11
R123 153 000 8-8
R123 153 003 8-8
R123 154 000 8-8
R123 154 003 8-8
R123 172 000 8-8
R123 174 000 8-8
R123 175 000 8-8
R123 176 000 8-8
R123 177 100.8-8, 18-38
R123 305 023...8-9, 8-14
R123 312 000 8-9
R123 313 000 8-9
R123 314 000 8-9
R123 314 010.8-9, 18-38
R123 315 000 8-9
R123 326 003..8-9, 8-14
R123 415 000 8-9
R123 422 801 5-14
R123 425 100...8-9, 8-14
R123 426 003 8-10
R123 427 803 8-10
R123 444 827 8-10

Radiall part numbers

R123 464 110 8-9	R124 080 030.7-47,18-39	R124 654 003..... 7-50	R125 091 000..... 7-17
R123 553 000 8-9	R124 153 001 7-48	R124 667 143..... 7-51	R125 091 001..... 7-21
R123 590 027 8-9	R124 153 003 7-48	R124 680 120..... 7-51	R125 153 000..... 7-21
R123 680 003 8-10	R124 154 001 7-48	R124 680 123..... 7-51	R125 153 002..... 7-21
R123 682 827 8-10	R124 154 003 7-48	R124 681 000..... 7-51	R125 153 901..... 7-21
R123 682 880 8-10	R124 172 120 7-48	R124 681 800..... 7-51	R125 154 000..... 7-21
R123 703 000.8-11, 16-9	R124 172 123.7-48,18-35	R124 802 108..... 7-52	R125 154 002..... 7-21
R123 704 000.8-11, 16-9	R124 174 120 7-48		R125 154 901..... 7-20
R123 705 000.8-11, 16-9	R124 174 123 7-48	SMA	R125 163 200..... 7-20
R123 805 000 8-11	R124 175 110.7-48,18-36	R125 002 200 7-17	R125 170 402..... 7-20
	R124 175 120 7-48	R125 051 000 7-18	R125 172 000..... 7-20
	R124 175 123 7-48	R125 052 000 7-18	R125 172 001..... 7-20
	R124 175 200.7-48,18-37	R125 052 002 7-18	R125 174 000..... 7-20
	R124 175 310.7-48,18-38	R125 052 170 7-18	R125 175 000..... 7-20
	R124 176 120 7-48	R125 052 500 7-18	R125 175 001..... 7-20
	R124 176 123 7-48	R125 052 702 7-18	R125 176 000..... 7-20
	R124 222 003 7-48	R125 052 901 7-19	R125 176 001..... 7-20
	R124 233 123 7-48	R125 053 901 7-19	R125 176 505..... 7-20
	R124 236 123 7-48	R125 054 000 7-18	R125 222 000..... 7-23
	R124 252 003 7-49	R125 054 002 7-18	R125 225 000..... 7-23
	R124 255 003 7-49	R125 054 500 7-18	R125 225 900..... 7-23
	R124 256 003 7-49	R125 054 901 7-19	R125 236 000..... 7-21
	R124 310 023 7-49	R125 055 000 7-18	R125 237 000..... 7-21
	R124 312 120 7-49	R125 055 002 7-18	R125 238 000..... 7-21
	R124 312 123.7-49,18-35	R125 055 500 7-18	R125 251 000..... 7-23
	R124 314 120 7-49	R125 055 702 7-18	R125 252 000..... 7-23
	R124 315 120 7-49	R125 055 901 7-19	R125 255 000..... 7-23
	R124 325 003 7-49	R125 057 002 7-18	R125 256 000..... 7-23
	R124 326 003 7-49	R125 069 000 7-17	R125 272 000..... 7-21
	R124 403 123 7-50	R125 071 120 7-17	R125 277 000..... 7-21
	R124 413 025 7-50	R125 072 000 7-17	R125 303 000..... 7-24
	R124 415 273 7-50	R125 072 001 7-17	R125 303 001..... 7-24
	R124 422 001.5-14, 7-51	R125 072 080 7-17	R125 305 000..... 7-25
	R124 423 033 7-51	R125 072 220 7-17	R125 308 000..... 7-24
	R124 423 223 7-51	R125 073 000 7-17	R125 312 120..... 7-24
	R124 426 120..... 7-51	R125 073 001..... 7-17	R125 313 120..... 7-24
	R124 426 123..... 7-51	R125 075 000..... 7-17	R125 314 120..... 7-24
	R124 427 000..... 7-51	R125 076 000..... 7-17	R125 315 120..... 7-24
	R124 427 800..... 7-51	R125 076 001..... 7-17	R125 320 020..... 7-24
	R124 454 123..... 7-50	R125 077 000..... 7-17	
	R124 464 000..... 7-50	R125 078 000..... 7-17	
	R124 510 000..... 7-50	R125 078 001..... 7-17	

WQMA

R123W 054 000 8-14
R123W 055 000 8-14
R123W 076 310 8-14, 18-38
R123W 096 100 8-14
R123W 153 000 8-14
R123W 154 000 8-14
R123W 176 000 8-14
R123W 177 110 8-14, 18-38
R123W 805 700 8-14
R123W 805 710 8-14

SMA-COM

R124 052 013 7-47
R124 054 003 7-47
R124 055 003 7-47
R124 069 120 7-47
R124 069 123 7-47
R124 071 120 7-47
R124 071 123.7-47,18-35
R124 072 220 7-47
R124 075 210.7-47,18-36
R124 075 320 7-47
R124 075 323 7-47
R124 076 320 7-47
R124 076 323 7-47
R124 076 430.7-47,18-38
R124 076 450.7-47,18-37

Radiall part numbers

R125 321 020..... 7-24	R125 464 271..... 7-28	R125 612 120..... 7-29	R125 852 000..... 7-36
R125 322 030..... 7-24	R125 464 274..... 7-28	R125 617 001..... 7-31	R125 852 001..... 7-36
R125 325 000..... 7-25	R125 465 000..... 7-33	R125 620 000..... 7-29	R125 943 001..... 7-29
R125 326 000..... 7-25	R125 465 001..... 7-33	R125 622 000..... 7-29	
R125 403 000..... 7-26	R125 465 010..... 7-33	R125 630 000..... 7-34	SMA 2.9
R125 403 001..... 7-26	R125 465 011..... 7-33	R125 630 040..... 7-34	R127 052 001..... 10-16
R125 410 000..... 7-32	R125 474 000..... 7-29	R125 638 001..... 7-34	R127 055 001..... 10-16
R125 410 001..... 7-32	R125 474 001..... 7-29	R125 653 001..... 7-26	R127 601 001..... 10-17
R125 411 000..... 7-33	R125 480 001..... 7-32	R125 654 000..... 7-26	R127 601 421..... 10-17
R125 411 001..... 7-33	R125 481 001..... 7-33	R125 654 450..... 7-28	R127 631 001..... 10-17
R125 413 000..... 7-28	R125 481 011..... 7-33	R125 670 001..... 7-32	R127 632 001..... 10-17
R125 413 001..... 7-28	R125 483 000..... 7-27	R125 680 000..... 7-29	R127 703 001..... 10-18, 16-10
R125 414 000..... 7-28	R125 484 000..... 7-31	R125 703 000.7-35,16-10	R127 704 001..... 10-18, 16-10
R125 414 001..... 7-28	R125 484 001..... 7-31	R125 703 001.7-35,16-10	R127 705 001..... 10-18, 16-10
R125 414 004..... 7-28	R125 488 000..... 7-30	R125 704 000.7-35,16-10	R127 712 001..... 10-18, 16-10
R125 415 000..... 7-28	R125 488 001..... 7-30	R125 704 001.7-35,16-10	R127 732 100..... 10-18, 16-10
R125 415 001..... 7-28	R125 492 000..... 7-31	R125 705 000.7-35,16-10	R127 753 000..... 10-18, 16-10
R125 415 030..... 7-28	R125 492 001..... 7-31	R125 705 001.7-35,16-10	R127 800 001..... 10-16
R125 415 270..... 7-28	R125 497 000..... 7-30	R125 710 021..... 7-35	R127 800 101..... 10-16
R125 415 271..... 7-28	R125 501 000..... 7-29	R125 720 000..... 7-35, 16-10, 17-19	R127 820 001..... 10-17
R125 415 275..... 7-28	R125 501 001..... 7-29	R125 720 001.7-35, 16-10, 17-19	R127 840 021..... 10-17
R125 416 460..... 7-28	R125 510 000..... 7-29	R125 722 001..... 7-19	R127 841 001..... 10-17
R125 423 200..... 7-32	R125 510 001..... 7-29	R125 753 000.7-35,16-10	R127 842 001..... 10-17
R125 426 000..... 7-29	R125 510 500..... 7-29	R125 753 001.7-35,16-10	R127 842 101..... 10-17
R125 426 140..... 7-29	R125 510 501..... 7-29	R125 771 000.7-35,16-10	R127 870 001..... 10-18, 16-10
R125 430 001..... 7-32	R125 512 000..... 7-31	R125 771 001.7-35,16-10	R127 871 001..... 10-18, 16-10
R125 433 000..... 7-27	R125 512 001..... 7-31	R125 780 000.7-35,16-10	R127 872 001..... 10-18, 16-10
R125 444 000..... 7-29	R125 513 000..... 7-31	R125 780 001.7-35,16-10	
R125 444 001..... 7-29	R125 541 000..... 7-32	R125 781 000.7-35,16-10	
R125 451 000..... 7-30	R125 553 000..... 7-27	R125 781 001.7-35,16-10	
R125 452 000..... 7-30	R125 553 001..... 7-27	R125 791 501.7-35, 16-5, 16-10	
R125 453 000..... 7-26	R125 555 500..... 7-27	R125 792 501.7-35, 16-5, 16-10	
R125 454 000..... 7-26	R125 556 001..... 7-34		
R125 454 001..... 7-26	R125 556 011..... 7-34		
R125 460 000..... 7-32	R125 560 000..... 7-27		
R125 460 001..... 7-32	R125 605 300..... 7-35		
R125 462 000..... 7-31	R125 605 301..... 7-35		
R125 462 001..... 7-31	R125 609 000..... 7-34		
R125 463 000..... 7-31	R125 609 001..... 7-34		
R125 464 000..... 7-28	R125 609 011..... 7-34		
R125 464 001..... 7-28	R125 609 031..... 7-34		
R125 464 270..... 7-28	R125 610 000..... 7-30		

BMA

R128 052 000..... 7-6
R128 052 827..... 7-6
R128 052 901..... 7-6
R128 053 000..... 7-6

Radiall part numbers

R128 055 000..... 7-6	R128 474 211..... 7-9	R141 082 097..... 15-22	R141 403 000..... 9-20
R128 055 827..... 7-6	R128 474 847..... 7-9	R141 082 161.9-16,17-13	R141 404 000..... 9-20
R128 056 000..... 7-6	R128 474 857..... 7-9	R141 083 000..... 9-16	R141 406 000..... 9-20
R128 081 001..... 7-6	R128 481 001..... 7-10	R141 153 000..... 9-17	R141 407 000..... 9-20
R128 083 001..... 7-6	R128 481 011..... 7-10	R141 154 000..... 9-17	R141 410 000..... 9-20
R128 083 827..... 7-6	R128 484 001..... 7-9	R141 156 000..... 9-17	R141 426 000..... 9-22
R128 084 827..... 7-6	R128 490 021..... 7-10	R141 181 161..... 9-17	R141 426 161..... 9-22
R128 088 827..... 7-6	R128 545 011..... 7-10	R141 182 000..... 9-17	R141 426 168..... 9-22
R128 233 701..... 7-7	R128 555 101..... 7-10	R141 182 161..... 9-17	R141 440 000..... 9-22
R128 238 701..... 7-7	R128 556 001..... 7-10	R141 182 177.9-17,15-22	R141 453 000..... 9-20
R128 263 707..... 7-7	R128 595 001..... 7-10	R141 183 000..... 9-17	R141 554 000..... 9-21
R128 263 711..... 7-7	R128 609 701..... 7-10	R141 207 000..... 9-17	R141 557 000..... 9-21
R128 264 707..... 7-7	R128 639 000..... 7-10	R141 208 000..... 9-17	R141 559 000..... 9-21
R128 268 701..... 7-7	R128 639 001..... 7-10	R141 217 000..... 9-17	R141 563 161..... 9-21
R128 268 717..... 7-7	R128 639 020..... 7-10	R141 220 000..... 9-17	R141 572 000..... 9-21
R128 292 700..... 7-7	R128 639 071..... 7-10	R141 237 000..... 9-17	R141 574 000..... 9-21
R128 292 727..... 7-7	R128 639 100..... 7-10	R141 237 161..... 9-17	R141 574 161..... 9-21
R128 293 702..... 7-7	R128 665 100..... 7-8	R141 253 000..... 9-18	R141 580 000..... 9-22
R128 294 700..... 7-7	R128 665 820..... 7-8	R141 254 000..... 9-18	R141 603 000..... 9-21
R128 294 710..... 7-6	R128 705 711..... 7-11	R141 256 000..... 9-18	R141 605 000..... 9-21
R128 295 700..... 7-7		R141 257 000..... 9-18	R141 625 000..... 9-21
R128 295 727..... 7-7	DTF	R141 258 000..... 9-18	R141 654 000..... 9-20
R128 296 700..... 7-7	R139 705 023..... 16-9	R141 261 000..... 9-18	R141 665 000..... 9-22
R128 296 710..... 7-6		R141 277 000..... 9-18	R141 665 200..... 9-22
R128 359 707..... 7-8	BNC	R141 278 000..... 9-18	R141 680 000..... 9-20
R128 360 701..... 7-8	R141 003 000..... 9-16	R141 290 200..... 9-18	R141 703 000.9-23, 16-9
R128 360 717..... 7-8	R141 004 000..... 9-16	R141 292 000..... 9-18	R141 704 000.9-23, 16-9
R128 368 707..... 7-8	R141 005 000..... 9-16	R141 301 000.9-19,17-19	R141 710 000.9-23, 16-9
R128 405 161..... 7-8	R141 007 000..... 9-16	R141 303 503.9-19,17-19	R141 717 000.9-23, 16-9
R128 414 701..... 7-9	R141 007 161..... 9-16	R141 304 000.9-19,17-19	R141 720 000.9-23, 16-9
R128 424 848..... 7-8	R141 008 000..... 9-16	R141 306 000.9-19,17-19	R141 723 000.9-23, 16-9
R128 424 860..... 7-8	R141 009 000..... 9-16	R141 306 503.9-19,17-19	R141 723 161.9-23, 16-9
R128 425 110..... 7-8	R141 010 000..... 9-16	R141 308 000.9-19,17-19	R141 730 000.9-23, 16-9,
R128 425 300..... 7-8	R141 012 000..... 9-16	R141 323 000.9-19,17-19	17-19
R128 425 820..... 7-8	R141 018 000..... 9-16	R141 324 000.9-19,17-19	R141 753 000.9-23, 16-9,
R128 426 700..... 7-9	R141 052 000..... 9-16	R141 324 200..... 9-19	17-19
R128 426 710..... 7-9	R141 070 520..... 9-16	R141 327 000.9-19,17-19	R141 770 000.9-23, 16-9,
R128 427 700..... 7-9	R141 072 000..... 9-16	R141 331 500..... 9-19	17-19
R128 444 201..... 7-9	R141 075 000..... 9-16	R141 332 161..... 17-19	R141 780 000.9-23, 16-9
R128 444 307..... 7-9	R141 077 000..... 9-16	R141 332 500.9-19,17-19	R141 782 000.9-23, 16-9
R128 464 701..... 7-9	R141 082 000..... 9-16	R141 338 000.9-19,17-19	R141 789 000.9-23, 16-9
R128 474 201..... 7-9		R141 338 007.9-19,15-22	

Radiall part numbers

R141 799 000.9-23, 16-9	R142 079 768..... 9-12	R142 562 290..... 17-19	R143 082 200..... 11-27,
R141 802 000.9-24,14-19	R142 079 769..... 9-12	R142 567 703..... 9-14	18-37
R141 805 000..... 9-24	R142 079 770..... 9-12	R142 568 703..... 9-14	R143 082 700..... 10-10
R141 812 000.9-24,14-19	R142 079 771..... 9-12	R142 676 430..... 9-28	R143 083 000..... 11-27
R141 842 000.9-24,14-19	R142 079 772..... 9-12	R142 676 700..... 9-14	R143 084 161..... 11-27,
R141 862 000..... 9-24	R142 079 773..... 9-12	R142 684 130..... 9-28	18-38
R141A 075 161..... 9-16	R142 079 774..... 9-12	R142 703 000.9-29, 16-9	R143 088 101..... 10-10
R141A 082 161..... 9-16	R142 079 775..... 9-12	R142 703 703.9-15, 16-9	R143 089 117..... 11-27,
R141A 306 000..... 9-19	R142 079 776..... 9-12	R142 704 000.9-29, 16-9	18-39
R141A 605 000..... 9-21	R142 079 777..... 9-12	R142 710 000.9-29, 16-9	R143 089 700..... 10-10
R141A 720 000..... 9-23	R142 079 778..... 9-12	R142 720 000.9-29, 16-9,	R143 092 790..... 10-10
R142 004 000..... 9-25	R142 079 779..... 9-12	17-19	R143 093 700..... 10-10
R142 016 000..... 9-25	R142 081 120..... 9-25	R142 720 700.9-15, 16-9	R143 097 700..... 10-10
R142 016 161..... 9-25	R142 081 130..... 9-25	R142 723 000.9-29, 16-9	R143 154 100..... 11-28
R142 017 000..... 9-25	R142 083 000..... 9-25	R142 770 000.9-29, 16-9	R143 156 000..... 11-28
R142 018 000..... 9-25	R142 085 000..... 9-25	R142 780 000.9-29, 16-9	R143 181 161..... 11-28
R142 076 000..... 9-25	R142 085 161.9-25,17-13	R142 782 000.9-29, 16-9	R143 182 000..... 11-28
R142 076 161..... 9-25	R142 085 702..... 9-13	R142 789 000.9-29, 16-9	R143 183 000..... 11-28
R142 077 702..... 9-13	R142 086 161..... 9-25	R142A 076 161..... 9-25	R143 188 101..... 10-10
R142 077 712..... 9-13	R142 090 000..... 9-25	R142A 081 130..... 9-25	R143 191 700..... 10-10
R142 077 722..... 9-13	R142 091 161..... 9-25	R142A 085 161..... 9-25	R143 207 000..... 11-29
R142 077 732..... 9-13	R142 095 000..... 9-25	R142A 306 500..... 9-27	R143 227 700..... 10-11
R142 077 742..... 9-13	R142 154 000..... 9-26	R142A 325 106..... 9-27	R143 235 161..... 11-28
R142 077 747..... 9-13	R142 157 000..... 9-26	R142A 334 161..... 9-27	R143 236 020..... 11-28
R142 079 750..... 9-12	R142 184 000..... 9-26		R143 237 000..... 11-28
R142 079 751..... 9-12	R142 184 161..... 9-26	TNC	R143 254 000..... 11-29
R142 079 752..... 9-12	R142 187 720..... 9-13	R143 004 000..... 11-27	R143 257 440..... 11-29
R142 079 753..... 9-12	R142 202 000..... 9-27	R143 008 000..... 11-27	R143 258 000..... 11-29
R142 079 754..... 9-12	R142 217 000..... 9-26	R143 012 000..... 11-27	R143 272 700..... 10-11
R142 079 755..... 9-12	R142 242 000..... 9-26	R143 018 000..... 11-27	R143 273 700..... 10-11
R142 079 756..... 9-12	R142 242 161..... 9-26	R143 018 500..... 11-27	R143 274 700..... 10-11
R142 079 757..... 9-12	R142 268 000..... 9-27	R143 051 700..... 10-10	R143 292 700..... 10-11
R142 079 758..... 9-12	R142 306 500.9-27,17-19	R143 052 000..... 11-27	R143 295 700..... 10-11
R142 079 759..... 9-12	R142 306 503.9-27,17-19	R143 054 700..... 10-10	R143 297 700..... 10-11
R142 079 760..... 9-12	R142 329 000.9-27,17-19	R143 072 000..... 11-27	R143 321 700..... 10-12
R142 079 761..... 9-12	R142 331 011..... 9-27	R143 073 000..... 11-27	R143 322 700..... 10-12
R142 079 762..... 9-12	R142 334 161.9-27,17-19	R143 075 000..... 11-27,	R143 323 000..... 11-30
R142 079 763..... 9-12	R142 334 700..... 9-14	18-35	R143 324 000..... 11-30
R142 079 764..... 9-12	R142 412 000..... 9-28	R143 082 000..... 11-27	R143 325 000..... 11-30
R142 079 765..... 9-12	R142 426 000..... 9-28	R143 082 027..... 11-27,	R143 331 161..... 11-29
R142 079 766..... 9-12	R142 500 740..... 9-14	18-36	R143 332 161..... 11-29
R142 079 767..... 9-12	R142 562 000..... 9-28	R143 082 161..... 11-27	R143 337 000..... 11-30

Radiall part numbers

R143 340 700..... 10-12	R143 812 000..... 11-31	R161 083 000..... 11-11	R161 286 000..... 11-14
R143 404 000..... 11-30	R143 835 000..... 11-31	R161 083 137..... 11-11	R161 311 200..... 11-15
R143 405 000..... 11-30	R143 850 700..... 10-13	R161 088 000..... 11-11	R161 311 300..... 11-15
R143 412 700..... 10-12	R144 085 000..... 11-31	R161 088 137..... 11-11	R161 321 000..... 11-15
R143 420 000..... 11-30	R144 085 161..... 11-31	R161 088 180..... 11-11,	R161 322 000..... 11-15
R143 422 947.5-14,11-31	R144 334 161..... 11-31	18-39	R161 323 000..... 11-16
R143 422 957.5-14,11-31		R161 152 107..... 11-13	R161 325 000..... 11-15
R143 440 000..... 11-31	UHF	R161 157 000..... 11-12	R161 329 000..... 11-15
R143 557 000..... 11-30	R155 003 000..... 14-22	R161 168 000..... 11-12	R161 329 130..... 11-15,
R143 603 000..... 11-30	R155 005 000..... 14-22	R161 181 000..... 11-12	18-37
R143 626 000..... 11-30	R155 404 161..... 14-22	R161 182 000..... 11-12	R161 329 140..... 11-15,
R143 654 000..... 11-31	R155 405 000..... 14-22	R161 182 080..... 11-12,	18-38
R143 703 000..... 11-32,	R155 560 000..... 14-22	18-37	R161 329 200..... 11-15
16-10	R155 705 000..... 16-10	R161 183 000..... 11-12	R161 331 060..... 11-15,
R143 703 700..... 10-13,		R161 183 310..... 11-12,	18-39
16-10	N	18-38	R161 331 200..... 11-15
R143 704 000..... 11-32,	R161 004 000..... 11-11	R161 184 080..... 11-12,	R161 331 400..... 11-15,
16-10	R161 006 000..... 11-11	18-39	18-40
R143 704 700..... 10-13,	R161 010 000..... 11-11	R161 185 000..... 11-12	R161 332 000..... 11-15
16-10	R161 012 000..... 11-11	R161 186 000..... 11-12	R161 335 200..... 11-16
R143 705 700..... 10-13,	R161 018 000..... 11-11	R161 187 000..... 11-12	R161 336 000..... 11-16
16-10	R161 020 000..... 11-11	R161 188 200..... 11-12,	R161 336 200..... 11-16
R143 710 000..... 11-32,	R161 022 000..... 11-11	18-40	R161 337 200..... 11-16
16-5, 16-10	R161 027 000..... 11-11	R161 206 000..... 11-13	R161 404 000..... 11-17
R143 710 700..... 10-13,	R161 050 300..... 11-12	R161 220 000..... 11-13	R161 404 137..... 11-17
16-10	R161 051 000..... 11-12	R161 226 020..... 11-13	R161 404 C01..... 11-18
R143 713 000..... 11-32,	R161 052 000..... 11-12	R161 227 000..... 11-13	R161 404 C02..... 11-18
16-5, 16-10	R161 053 000..... 11-12	R161 236 000..... 11-13	R161 404 C03..... 11-18
R143 713 200..... 11-32,	R161 054 000..... 11-12	R161 237 000..... 11-13	R161 410 000..... 11-17
16-10	R161 072 000..... 11-11,	R161 238 000..... 11-13	R161 410 130..... 11-17
R143 720 000..... 11-32,	18-35	R161 241 000..... 11-13	R161 410 520..... 11-16
16-10	R161 075 000..... 11-11	R161 243 000..... 11-13	R161 416 130..... 11-17
R143 730 700..... 10-13,	R161 075 030..... 11-11,	R161 252 000..... 11-14	R161 418 000..... 11-17
16-10	18-38	R161 256 000..... 11-14	R161 419 020..... 11-17
R143 753 000..... 11-32,	R161 075 060..... 11-11	R161 270 000..... 11-14	R161 419 30..... 11-17
16-10	R161 079 200..... 18-40	R161 277 000..... 11-14	R161 427 223..... 11-19
R143 770 000..... 11-32,	R161 082 000..... 11-11	R161 277 300..... 11-14	R161 428 223.5-15,11-19
16-10	R161 082 120..... 11-11,	R161 278 000..... 11-14	R161 428 233.5-15,11-19
R143 780 000..... 11-32,	18-36	R161 281 000..... 11-14	R161 438 200..... 11-17
16-10	R161 082 200..... 11-11,	R161 281 300..... 11-14	R161 441 000..... 11-17
R143 782 000..... 11-32,	18-37	R161 282 000..... 11-14	R161 441 400..... 11-17
16-10	R161 083 000..... 11-11	R161 283 000..... 11-14	R161 461 000..... 11-17

Radiall part numbers

R161 570 000..... 11-18
 R161 606 000..... 11-18
 R161 625 000..... 11-18
 R161 653 000..... 11-18
 R161 703 000.11-19,16-9
 R161 705 000.11-19,16-9
 R161 715 000.11-19,16-9
 R161 730 000.11-19,16-9
 R161 753 000.11-19,16-9
 R161 771 000.11-19,16-9
 R161 780 000.11-19,16-9
 R161 782 000.11-19,16-9
 R161 791 500..... 11-19,
 16-5, 16-9
 R161 791 530.11-19,16-9
 R161 804 000..... 11-20
 R161 805 410..... 11-20
 R161 841 000..... 11-20
 R161 844 000..... 11-20
 R161 853 000..... 11-20
 R161 862 000..... 11-20
 R161A 075 000..... 11-11
 R161A 183 000..... 11-12
 R161A 404 000..... 11-17
 R161A 410 000..... 11-17
 R162 012 000..... 11-21
 R162 013 000..... 11-21
 R162 017 000..... 11-21
 R162 084 000..... 11-21
 R162 217 000..... 11-21
 R162 262 000..... 11-21
 R162 322 000..... 11-21
 R162 403 000..... 11-22
 R162 570 000..... 11-22
 R162 703 000.11-22,16-9
 R162 705 000.11-22,16-9

N 18

R163 337 001..... 10-7
 R163 703 001. 10-7, 16-9
 R163 705 001. 10-7, 16-9
 R163 708 001. 10-7, 16-9

QN

R164 054 002..... 8-16
 R164 075 000..... 8-16
 R164 075 010.8-16,18-38
 R164 076 000..... 8-16
 R164 080 000..... 8-16
 R164 080 020.8-16,18-39
 R164 080 030.8-16,18-40
 R164 152 100..... 8-17
 R164 175 000..... 8-17
 R164 176 000..... 8-17
 R164 184 000..... 8-17
 R164 185 007.8-17,18-39
 R164 241 020.8-17,18-39
 R164 286 000..... 8-17
 R164 329 200..... 8-18
 R164 336 000..... 8-17
 R164 418 000..... 8-18
 R164 428 823..... 5-15
 R164 428 833..... 5-15
 R164 540 027..... 8-18
 R164 571 027..... 8-18
 R164 606 000..... 8-19
 R164 606 020..... 8-19
 R164 635 002..... 8-18
 R164 705 000.8-19, 16-9
 R164 708 000.8-19, 16-9
 R164 804 000..... 8-20

C

R166 005 000..... 11-37
 R166 018 000..... 11-37
 R166 088 100..... 11-37
 R166 092 190..... 11-37
 R166 093 000..... 11-37
 R166 094 000..... 11-37
 R166 160 020..... 11-37
 R166 168 000..... 11-37
 R166 191 000..... 11-37
 R166 194 190..... 11-37
 R166 218 000..... 11-37

R166 256 000..... 11-37
 R166 268 000..... 11-37
 R166 404 000..... 11-38
 R166 404 001..... 11-38
 R166 705 000.11-38,16-9
 R166 753 000.11-38,16-9
 R166 770 000.11-38,16-9

4.1-9.5

R170 031 007..... 13-25
 R170 031 107..... 13-25
 R170 031 207..... 13-25
 R170 152 107..... 13-25
 R170 413 127..... 13-25
 R170 703 007..... 16-9

HN

R176 006 000..... 15-5
 R176 012 000..... 15-5
 R176 018 000..... 15-5
 R176 019 000..... 15-5
 R176 021 000..... 15-5
 R176 027 000..... 15-5
 R176 218 000..... 15-5
 R176 256 000..... 15-5
 R176 268 000..... 15-5
 R176 404 000..... 15-5
 R176 754 000.15-6, 16-9
 R176 754 150.15-6, 16-9
 R176 770 000.15-6, 16-9
 R176 811 000..... 15-6
 R176 830 010..... 15-6

4.3-10

R183 010 007..... 13-21
 R183 010 017..... 13-21
 R183 030 007..... 13-21
 R183 030 017..... 13-21
 R183 031 007..... 13-21
 R183 031 017..... 13-21
 R183 032 007..... 13-21

R183 052 007..... 13-21
 R183 165 007..... 13-22
 R183 197 007..... 13-21
 R183 252 007..... 13-22
 R183 405 067..... 13-22
 R183 804 020..... 13-22

QLI

R184 006 007..... 13-17
 R184 018 007..... 13-17
 R184 037 007..... 13-17
 R184 061 007..... 13-17
 R184 062 007..... 13-17
 R184 082 007..... 13-17
 R184 086 007..... 13-17
 R184 087 007..... 13-17
 R184 191 007..... 13-17
 R184 216 007..... 13-17
 R184 282 007..... 13-18
 R184 335 007..... 13-18
 R184 339 007..... 13-18
 R184 405 007..... 13-18
 R184 960 007..... 13-18

7-16

R185 010 000..... 13-9
 R185 054 020..... 13-9
 R185 074 000..... 13-9
 R185 077 000..... 13-9
 R185 077 010.13-9,18-40
 R185 083 310..... 13-9
 R185 085 007..... 13-9,
 18-38, 18-39
 R185 160 000..... 13-9
 R185 174 000..... 13-9
 R185 177 000..... 13-9
 R185 210 000..... 13-10
 R185 215 200..... 13-10
 R185 216 200..... 13-10
 R185 217 200..... 13-10
 R185 252 000..... 13-10

Radiall part numbers

R185 260 000..... 13-10	R191 201 007..... 16-7	R191 354 001..... 16-6	R191 553 000..... 3-17
R185 314 100..... 13-11	R191 201 800..... 16-6	R191 355 001..... 16-6	R191 553 800..... 16-6
R185 320 020..... 13-11, 18-38, 18-39	R191 203 007..... 16-7	R191 365 000..... 16-7	R191 560 000...3-9, 3-17
R185 403 490..... 13-11	R191 209 000..... 16-6	R191 366 071.5-11, 16-4	R191 562 000.2-10, 16-5
R185 403 547..... 13-11	R191 212 000..... 16-6	R191 366 091.5-11, 16-4	R191 563 000.2-10, 16-5
R185 404 200..... 13-11	R191 212 500..... 16-6	R191 374 000..... 16-7	R191 564 000.2-10, 16-5
R185 405 200..... 13-11	R191 213 000..... 16-6	R191 377 000..... 16-7	R191 565 000.2-10, 16-5
R185 406 090..... 13-11	R191 214 000..... 16-6	R191 381 000..... 16-7	R191 570 100..... 16-8
R185 703 000.13-12,16-9	R191 215 000..... 16-6	R191 385 000..... 16-6	R191 591 007..... 16-6
R185 705 000.13-12,16-9	R191 233 000..... 16-7	R191 386 000..... 16-6	R191 591 017..... 16-6
R185 707 000.13-12,16-9	R191 236 000..... 16-7	R191 387 000..... 16-6	R191 592 007..... 16-6
R185 710 000.13-12,16-9	R191 239 000..... 16-7	R191 387 107..... 16-6	R191 592 017..... 16-6
R185 730 020.13-12,16-9	R191 300 800..... 16-6	R191 388 000..... 16-6	R191 593 400..... 2-25
R185 812 007..... 13-12	R191 301 000..... 16-6	R191 389 100...3-9, 16-6	R191 597 800...1-7, 16-6
R187 130 000..... 13-13	R191 303 000..... 16-6	R191 389 200...3-9, 16-6	R191 662 000..... 16-4
R187 403 000..... 13-13	R191 305 000..... 16-6	R191 389 300 ..3-9, 16-6	R191 663 000..... 16-4
R187 403 010..... 13-13	R191 309 000..... 16-8	R191 389 400 ..3-9, 16-6	R191 664 000..... 16-4
R187 403 100..... 13-13	R191 311 000..... 16-7	R191 389 800..... 16-6	R191 665 000..... 16-4
R187 406 000..... 13-13	R191 313 000..... 16-7	R191 394 027..... 1-12	R191 703 000..... 16-6
R187 406 100..... 13-13	R191 314 700..... 16-5	R191 398 020..... 16-6	R191 705 000..... 16-6
R187 413 000..... 13-13	R191 314 730..... 16-5	R191 399 100..... 16-6	R191 708 000..... 16-6
R187 413 100..... 13-13	R191 315 000..... 16-7	R191 403 000..... 16-6	R191 720 000..... 16-6
R187 416 000..... 13-13	R191 316 700..... 16-5	R191 405 000..... 16-6	R191 721 000..... 16-6
R187 416 100..... 13-13	R191 318 700..... 16-5	R191 417 000..... 16-6	R191 722 000..... 16-6
	R191 324 000..... 16-5	R191 419 000..... 16-6	R191 723 000..... 16-6
	R191 325 000..... 16-7	R191 421 000..... 16-6	R191 731 000..... 16-7
	R191 326 000..... 16-5	R191 422 000..... 16-6	R191 733 000..... 16-7
	R191 327 000..... 16-7	R191 424 000..... 16-6	R191 737 000..... 16-6
	R191 328 000..... 16-5	R191 429 000..... 16-6	R191 741 000..... 16-6
	R191 329 000..... 16-7	R191 445 000..... 16-6	R191 757 000.8-19, 16-4
	R191 330 000..... 16-5	R191 447 000..... 16-8	R191 758 000..... 8-19
	R191 331 000..... 16-7	R191 449 000..... 16-6	R191 759 000.8-19, 16-4
	R191 332 000..... 16-7	R191 450 000..... 20-30	R191 760 000.8-19, 16-4
	R191 333 000..... 16-5	R191 453 000.16-6,20-30	R191 760 010..... 16-4
	R191 334 000..... 16-7	R191 454 000.16-6,20-30	R191 762 000.8-19, 16-4
	R191 347 000..... 16-7	R191 455 000.16-6,20-30	R191 763 000.8-19, 16-4
	R191 349 000..... 16-7	R191 477 120..... 16-6	R191 764 000.8-19, 16-4
	R191 350 001..... 16-6	R191 511 000..... 16-7	R191 765 000.8-19, 16-4
	R191 351 701..... 16-6	R191 513 000..... 16-7	R191 792 000..... 16-4
	R191 352 001..... 16-6	R191 513 050..... 16-7	R191 793 000..... 16-4
	R191 353 701..... 16-6	R191 514 000..... 16-7	R191 794 000..... 16-4
	R191 353 711..... 16-6	R191 552 000..... 3-17	R191 811 110..... 16-6

ADAPTERS

R191 003 000..... 16-5	R191 007 000..... 16-5	R191 009 000..... 16-5	R191 010 000..... 16-5	R191 011 000..... 16-5	R191 012 000..... 16-5	R191 013 000..... 16-5	R191 015 000..... 16-5	R191 025 000..... 16-5	R191 027 000..... 16-5	R191 117 000..... 16-6	R191 120 000..... 16-6	R191 123 000..... 16-6	R191 124 000..... 16-6	R191 200 007..... 16-7
------------------------	------------------------	------------------------	------------------------	------------------------	------------------------	------------------------	------------------------	------------------------	------------------------	------------------------	------------------------	------------------------	------------------------	------------------------

Radiall part numbers

R191 841 001.2-21, 16-7
 R191 842 002.2-21, 16-7
 R191 843 001.2-21, 16-7
 R191 843 409.2-21, 16-7
 R191 843 429.2-21, 16-7
 R191 844 002.2-21, 16-7
 R191 844 800..... 16-6
 R191 857 000...5-8, 16-4
 R191 907 000..... 16-6
 R191 908 000..... 16-6
 R191 910 000.8-11, 16-4
 R191 911 000.8-11, 16-4
 R191 912 000.8-11, 16-4
 R191 913 000.8-11, 16-4
 R191 923 000..... 16-4
 R191 926 L01.8-23, 16-4
 R191 927 L01.8-23, 16-4
 R191 933 000..... 16-6
 R191 944 700..... 16-4
 R191 946 700..... 16-4
 R191 956 020.2-10, 16-5
 R191 957 000.2-10, 16-5
 R191 958 000.2-10, 16-5
 R191 958 020.2-10, 16-5
 R191 959 000.2-21, 16-5
 R191 966 001.2-21, 16-5
 R191 967 002.2-21, 16-5
 R191 968 001.2-21, 16-5
 R191 969 002.2-21, 16-5
 R191 970 061.10-19,16-5
 R191 970 071.10-19,16-5
 R191 970 081.10-19,16-5
 R191 970 091.10-19,16-5
 R191 975 781.1-12, 16-4
 R191 975 791..... 1-12
 R191 976 020..... 16-4
 R191 977 020..... 16-4
 R191 977 520..... 16-5
 R191 984 008..... 16-4
 R191 996 110..... 3-17
 R191 996 130..... 3-17
 R192 417 010..... 9-15

R192 418 000..... 16-4
 R192 418 010..... 9-15
 R192 419 000..... 16-4
 R192 421 000..... 16-4

COAXIPACK 2

R199 001 003..... 4-13
 R199 001 023..... 4-13
 R199 001 053..... 4-13
 R199 001 203..... 4-10
 R199 001 223..... 4-10
 R199 001 703.4-11, 16-9
 R199 001 713.4-11, 16-9
 R199 001 733.4-11, 16-9

MC-CARD

R199 005 200..... 5-10
 R199 005 233..... 5-10
 R199 005 240..... 5-10
 R199 005 250..... 5-10
 R199 005 273..... 5-10
 R199 005 310..... 5-10
 R199 005 800..... 5-10
 R199 005 820..... 5-10
 R199 005 890..... 5-11

MOEBIUS

R199 006 203..... 5-8
 R199 006 213 5-8
 R199 006 263..... 5-8
 R199 006 273..... 5-8
 R199 006 413..... 5-7
 R199 006 813..... 5-7

SMPM

R201 051 000..... 2-7
 R201 052 000..... 2-7
 R201 151 000..... 2-7
 R201 152 000..... 2-7
 R201 170 110..... 2-7
 R201 223 100..... 2-7

R201 223 700..... 2-7
 R201 223 710..... 2-7
 R201 423 110..... 2-8
 R201 423 200..... 2-8
 R201 423 700..... 2-8
 R201 450 001..... 2-9
 R201 450 701..... 2-9
 R201 508 000..... 2-8
 R201 508 040..... 2-8
 R201 508 700..... 2-8
 R201 561 021..... 2-9
 R201 561 721..... 2-9
 R201 645 000..... 2-8
 R201 645 020..... 2-8
 R201 645 700..... 2-8
 R201 645 710..... 2-8
 R201 645 720..... 2-8
 R201 705 000..... 2-9
 R201 705 110..... 2-9
 R201 705 120..... 2-9
 R201 723 1_0..... 2-9

SSMB

R203 073 000..... 12-8
 R203 075 000..... 12-8
 R203 173 000..... 12-8
 R203 173 080..... 12-8
 R203 175 000..... 12-8
 R203 313 000..... 12-9
 R203 426 000..... 12-10
 R203 553 000..... 12-9
 R203 665 000..... 12-11

MMS

R209 351 020..... 1-11
 R209 353 000..... 1-11
 R209 408 012..... 1-12
 R209 408 052..... 1-12
 R209 408 302..... 1-12
 R209 703 070.1-12, 16-9

MMT

R210 157 010..... 1-11
 R210 160 020..... 1-11
 R210 408 012..... 1-12
 R210 408 052..... 1-12
 R210 408 302..... 1-12
 R210 703 507..... 16-9

MCX

R213 053 037..... 1-21
 R213 082 007..... 1-21
 R213 083 007..... 1-21
 R213 182 007..... 1-21
 R213 183 007..... 1-21
 R213 238 007..... 1-22
 R213 424 800..... 1-23
 R213 664 800..... 1-24
 R213 665 000..... 1-24

TYPE 43

R214 083 922 14-6
 R214 088 902..... 14-7
 R214 088 922..... 14-7
 R214 318 702..... 14-7
 R214 318 722..... 14-7
 R214 320 702..... 14-7
 R214 320 722..... 14-7
 R214 325 742..... 14-7
 R214 426 704..... 14-6
 R214 553 000..... 14-6
 R214 790 703..... 14-8
 R214 791 703..... 14-8
 R214 797 703..... 14-8
 R214 797 723..... 14-8
 R214 798 703..... 14-8
 R214 798 723..... 14-8

Radiall part numbers

SMP

R222 051 000..... 2-15
 R222 052 000..... 2-15
 R222 052 300..... 2-15
 R222 062 100..... 2-15
 R222 151 000..... 2-15
 R222 152 000..... 2-15
 R222 162 100..... 2-15
 R222 223 002..... 2-15
 R222 223 302..... 2-15
 R222 223 702..... 2-15
 R222 252 001..... 2-16
 R222 252 301..... 2-16
 R222 252 702..... 2-16
 R222 302 002..... 2-15
 R222 302 302..... 2-15
 R222 302 702..... 2-15
 R222 402 021..... 2-19
 R222 402 321..... 2-19
 R222 402 721..... 2-19
 R222 408 350..... 2-17
 R222 408 750..... 2-17
 R222 411 001..... 2-18
 R222 414 711..... 2-18
 R222 423 023..... 2-17
 R222 423 041..... 2-16
 R222 423 320..... 2-17
 R222 423 720..... 2-17
 R222 426 000..... 2-16
 R222 426 020..... 2-16
 R222 426 300..... 2-16
 R222 426 320..... 2-16
 R222 426 700..... 2-16
 R222 426 720..... 2-16
 R222 428 000..... 2-17
 R222 428 300..... 2-17
 R222 428 700..... 2-17
 R222 450 001..... 2-19
 R222 508 000..... 2-17, 2-21
 R222 508 300..... 2-17, 2-21
 R222 508 700..... 2-17, 2-21
 R222 508 722..... 2-17, 2-21

R222 550 001..... 2-20
 R222 550 301..... 2-20
 R222 550 701..... 2-20
 R222 561 001..... 2-18
 R222 561 301..... 2-18
 R222 561 331..... 2-18
 R222 561 701..... 2-18
 R222 645 000..... 2-19
 R222 645 020..... 2-19
 R222 645 300..... 2-19
 R222 645 320..... 2-19
 R222 645 700..... 2-19
 R222 680 000..... 2-18
 R222 680 300..... 2-18
 R222 680 700..... 2-18
 R222 680 710..... 2-17, 2-21
 R222 705 000..... 2-20
 R222 705 200..... 2-20
 R222 705 210..... 2-20
 R222 705 220..... 2-20
 R222 705 239..... 2-20
 R222 705 250..... 2-20
 R222 705 320..... 2-20
 R222 705 340..... 2-20
 R222 705 360..... 2-20
 R222 705 370..... 2-20
 R222 705 380..... 2-20
 R222 705 400..... 2-20
 R222 723 110..... 2-20
 R222 723 120..... 2-20
 R222 723 140..... 2-20

SMP-COM

R222 900 100..... 2-27
 R222 900 130..... 2-27
 R222 900 200..... 2-27
 R222 900 310..... 2-27
 R222 900 320..... 2-27
 R222 900 330..... 2-27
 R222 900 340..... 2-27
 R222 900 357..... 15-20
 R222 940 100..... 2-28

R222 940 300..... 2-28
 R222 940 700..... 2-28
 R222 941 100..... 2-28
 R222 941 300..... 2-28
 R222 941 324..... 15-21
 R222 941 700..... 2-28
 R222 995 320..... 2-28

SMP-LOCK

R222 L00 000..... 2-24
 R222 L00 010..... 2-24
 R222 L00 020..... 2-24
 R222 L00 040..... 2-24
 R222 L10 001..... 2-24
 R222 L10 010..... 2-25
 R222 L10 020..... 2-25
 R222 L10 040..... 2-25
 R222 L80 010..... 2-24
 R222 L80 300..... 2-24

SMP-MAX

R222 M00 080..... 3-16
 R222 M00 090..... 3-16
 R222 M00 160..... 3-16
 R222 M00 700..... 3-15
 R222 M00 720..... 3-15
 R222 M00 730..... 3-15
 R222 M00 740..... 3-15
 R222 M00 770..... 3-15
 R222 M00 790..... 3-15
 R222 M00 860..... 3-15
 R222 M00 880..... 3-15
 R222 M00 890..... 3-15
 R222 M01 000..... 3-16
 R222 M01 040..... 3-16
 R222 M01 090..... 3-16
 R222 M01 140..... 3-16
 R222 M03 000..... 3-16
 R222 M03 700..... 3-15
 R222 M03 880..... 3-15
 R222 M10 000..... 3-16

R222 M10 030..... 3-16
 R222 M10 060..... 3-16
 R222 M10 700..... 3-15
 R222 M10 730..... 3-15
 R222 M10 750..... 3-15
 R222 M20 017..... 3-14
 R222 M20 700..... 3-14
 R222 M20 710..... 3-14
 R222 M40 010..... 3-16
 R222 M40 050..... 3-16
 R222 M40 060..... 3-16
 R222 M40 070..... 3-16
 R222 M40 080..... 3-16
 R222 M43 052..... 3-16
 R222 M43 072..... 3-16
 R222 M43 112..... 3-16
 R222 M43 192..... 3-16
 R222 M43 202..... 3-16
 R222 M43 212..... 3-16
 R222 M43 222..... 3-16
 R222 M43 262..... 3-16
 R222 M46 012..... 3-16
 R222 M46 032..... 3-16
 R222 M80 400..... 3-14
 R222 M80 500..... 3-14
 R222 M80 517..... 3-14

MMBX

R223 062 000..... 3-7
 R223 081 000..... 3-7
 R223 082 000..... 3-7
 R223 083 000..... 3-7
 R223 162 000..... 3-7
 R223 181 000..... 3-7
 R223 182 000..... 3-7
 R223 183 000..... 3-7
 R223 423 010..... 3-8
 R223 423 800..... 3-8
 R223 424 000..... 3-8
 R223 424 800..... 3-8
 R223 424 870..... 3-8
 R223 425 000..... 3-8

Radiall part numbers

R223 425 800..... 3-8	R280 420 300..... 4-14	R280 566 006..... 17-22	10-23, 17-18
R223 425 810..... 3-8	R280 461 000..... 7-36,	R280 566 007..... 17-22	R280 760 050..... 17-18
R223 434 000..... 3-7	11-20, 17-17	R280 566 008..... 17-22	R280 902 000..... 17-19
R223 434 800..... 3-7	R280 461 200.7-36,17-17	R280 570 000..... 17-22	R280 907 000..... 17-19
R223 435 000..... 3-7	R280 461 210.7-36,17-17	R280 570 010..... 17-22	
R223 435 010..... 3-7	R280 462 000.7-36,17-17	R280 571 000..... 17-22	
R223 555 000..... 3-8	R280 463 000..... 7-36,	R280 572 000..... 17-22	
R223 703 020..... 3-9	11-20, 17-17	R280 573 000..... 17-22	
R223 703 040..... 3-9	R280 465 000.7-36,17-17	R280 574 000..... 17-22	
R223 703 080..... 3-9	R280 467 000..... 17-17	R280 575 000..... 17-22	
R223 703 180..... 3-9	R280 468 000..... 11-20,	R280 576 000..... 17-22	
R223 703 230..... 3-9	17-17	R280 577 000..... 17-22	
R223 720 020..... 3-9	R280 468 120..... 17-17	R280 578 000..... 17-22	
R223 990 000..... 3-10	R280 468 140..... 17-17	R280 579 000..... 17-22	
	R280 469 000..... 11-38,	R280 590 000..... 17-22	
	17-17	R280 591 000..... 17-22	
	R280 469 010..... 11-38,	R280 592 000..... 17-22	
	17-17	R280 593 000..... 17-22	
	R280 470 000..... 17-17	R280 594 000..... 17-22	
	R280 470 050..... 17-17	R280 595 000..... 17-22	
	R280 473 100..... 17-17	R280 596 000..... 17-22	
	R280 473 130..... 17-17	R280 597 000..... 17-22	
	R280 490 020..... 17-20	R280 598 000..... 17-22	
	R280 503 000..... 14-20,	R280 637 030..... 17-21	
	15-9, 17-20	R280 637 040..... 17-21	
	R280 505 000..... 17-20	R280 751 000.7-33,7-34,	
	R280 510 000.7-33,17-18	7-37, 17-18	
	R280 560 000..... 17-22	R280 751 080.7-37,17-18	
	R280 560 001..... 17-22	R280 751 350..... 7-34,	
	R280 560 002..... 17-22	7-37, 17-18	
	R280 560 003..... 17-22	R280 752 000..... 2-20,	
	R280 560 004..... 17-22	7-37, 17-18	
	R280 560 005..... 17-22	R280 752 020.7-37,17-18	
	R280 560 006..... 17-22	R280 755 000..... 7-34,	
	R280 560 007..... 17-22	7-37, 17-18	
	R280 560 008..... 17-22	R280 755 040.7-37,17-18	
	R280 566 000..... 17-22	R280 757 060..... 17-18	
	R280 566 001..... 17-22	R280 757 070..... 7-33,	
	R280 566 002..... 17-22	7-37, 17-18	
	R280 566 003..... 17-22	R280 757 080.7-37,17-18	
	R280 566 004..... 17-22	R280 760 000..... 17-18	
	R280 566 005..... 17-22	R280 760 040..... 10-18,	

TOOLING

R282 051 000..... 17-4, 17-8
R282 053 000..... 17-4, 17-9
R282 053 030..... 17-11
R282 053 100..... 17-9
R282 054 000..... 17-4
R282 055 000..... 17-4,
17-8, 17-9
R282 056 085..... 17-8
R282 056 118..... 17-4, 17-9
R282 059 010..... 17-11
R282 059 100..... 17-9
R282 061 030..... 17-11
R282 062 010..... 17-4
R282 063 000..... 17-4, 17-8
R282 066 000..... 17-4, 17-9
R282 066 100..... 17-9
R282 067 000..... 17-4, 17-9
R282 067 030..... 17-11
R282 078 000..... 17-11
R282 078 200..... 17-11
R282 078 220..... 17-11
R282 078 500..... 17-11
R282 080 000..... 17-5
R282 082 000..... 17-5
R282 102 000..... 17-8
R282 114 125..... 17-8
R282 114 162..... 17-9
R282 114 165..... 17-9
R282 120 010..... 17-9
R282 120 220..... 17-11
R282 122 010..... 17-10
R282 124 050..... 17-13
R282 124 075..... 17-13
R282 124 100..... 17-11
R282 125 010..... 17-10
R282 200 000..... 17-9

Radiall part numbers

R282 202 000..... 17-6	R282 360 004..... 17-6	R282 857 000..... 17-9	R284 008 001..... 1-11
R282 203 020..... 14-15	R282 370 020..... 17-10	R282 857 010..... 17-9	R284 008 004..... 1-11
R282 211 000..... 17-12	R282 730 040..... 17-9	R282 862 060..... 17-9	R284 906 002..... 14-14
R282 223 000..... 17-12, 17-13	R282 730 043..... 17-9	R282 862 070..... 17-10	R284C0431006..... 14-14
R282 227 000..... 17-12	R282 730 160..... 17-10	R282 862 080..... 17-10	R285 001 021..... 1-11
R282 231 000..... 17-11, 17-12	R282 730 161..... 17-10	R282 862 090..... 17-10	R285 004 001..... 1-11
R282 232 000..... 17-12	R282 740 000..... 17-5, 17-9, 17-10, 17-11	R282 862 100..... 17-10	R285 004 221..... 1-11
R282 234 000..... 17-12	R282 740 030..... 17-5, 17-10	R282 864 110..... 17-8	R285 011 221..... 1-11
R282 235 003..... 17-12	R282 744 000..... 17-10	R282 864 120..... 17-9	R285 020 202..... 14-14
R282 235 011..... 17-12	R282 744 003..... 17-10	R282 867 020..... 14-15, 17-16	R285 020 212..... 14-14
R282 235 013..... 17-12	R282 744 010..... 17-9	R282 867 030..... 14-15, 17-16	R285 020 401..... 14-14
R282 271 000..... 17-12	R282 744 011..... 17-9	R282 868 000..... 17-17	R285 024 071..... 1-13
R282 281 000..... 17-13	R282 744 060..... 17-9	R282 868 040..... 1-13, 17-16	R285 025 202..... 14-14
R282 293 000..... 17-12	R282 744 061..... 17-9	R282 868 100..... 1-13, 17-16	R285 025 212..... 14-14
R282 300 000..... 17-14	R282 744 062..... 17-9	R282 868 201..... 17-15	R285 025 401..... 14-14
R282 303 000..... 17-14	R282 744 063..... 17-9	R282 868 230..... 17-16	R285 930 005..... 4-14
R282 303 010..... 17-14	R282 744 100..... 17-9	R282 868 300..... 17-15	
R282 303 020..... 17-14	R282 744 190..... 17-11	R282 914 000..... 17-9	SPECIAL
R282 303 230..... 17-14	R282 744 192..... 17-11	R282 914 010..... 17-9	R299 122 087..... 15-19
R282 303 500..... 17-14	R282 744 200..... 17-9	R282 915 010..... 17-9	R299 122 097..... 15-19
R282 318 000..... 17-14	R282 744 201..... 17-9	R282 915 020..... 17-10	R299 137 800..... 5-13
R282 319 000..... 17-14	R282 744 220..... 17-9	R282 915 030..... 17-10	R299 137 801..... 5-13
R282 320 000..... 17-14	R282 744 260..... 17-10	R282 915 040..... 17-10	
R282 320 030..... 17-14	R282 744 261..... 17-10	R282 918 000..... 17-15	TOOLING
R282 320 031..... 17-14	R282 744 270..... 17-10	R282 918 120..... 17-15	R299 510 010..... 17-7
R282 323 000..... 17-11, 17-14	R282 744 271..... 17-10	R282 918 150..... 17-15	R299 511 011..... 17-7
R282 339 001..... 17-6	R282 744 300..... 17-10	R282 918 160..... 17-15	R299 511 012..... 17-7
R282 339 004..... 17-6	R282 744 310..... 17-10	R282 918 200..... 17-15	R299 511 013..... 17-7
R282 339 005..... 17-6	R282 744 320..... 17-10	R282 918 210..... 17-15	R299 511 016..... 17-7
R282 340 000..... 17-12, 17-6	R282 744 330..... 17-10	R282 920 010..... 14-15, 17-15	R299 520 000..... 17-7, 17-13
R282 341 010..... 17-34, 17-40, 17-5	R282 744 340..... 17-10	R282 920 100..... 14-15, 17-15	R299 521 011..... 17-7
R282 341 012..... 17-40, 17-5	R282 744 350..... 17-10	R282 920 120..... 17-15	R299 521 012..... 17-7
R282 344 127..... 17-8, 17-9	R282 750 000..... 17-8	R282 967 030..... 17-13	R299 521 013..... 17-7
R282 344 150..... 17-8, 17-9	R282 751 050..... 17-8	R282 983 000..... 17-13	R299 521 014..... 17-7
R282 360 001..... 17-6	R282 751 051..... 17-8		R299 521 015..... 17-7
R282 360 002..... 17-6	R282 751 070..... 17-8	CABLE ASSEMBLIES AND PIGTAILS	R299 521 017..... 17-7, 17-13
R282 360 003..... 17-6	R282 751 071..... 17-8	R284 007 013..... 1-13	R299 522 000..... 17-7
	R282 760 000..... 17-9		R299 550 000..... 17-7
	R282 800 000..... 17-4		
	R282 800 001..... 17-4		

Radiall part numbers

MC-CARD

R299 794 800..... 5-11

MML

R302 000 000 xxx..... 1-5
 R302 152 000..... 1-6
 R302 153 000..... 1-7
 R302 153 001..... 1-7
 R302 155 000 xxx..... 1-5
 R302 155 001..... 1-5
 R302 159 000..... 17-16
 R302 205 000 1-5
 R302 205 001 xxx..... 1-5
 R302 205 002..... 1-5
 R302 205 003 xxx..... 1-6
 R302 255 000 xxx..... 1-6
 R302 255 001 xxx..... 1-6
 R302 255 002 xxx..... 1-5
 R302 255 003 xxx..... 1-5
 R302 255 006 xxx..... 1-6
 R302 255 014 xxx..... 1-6
 R302 255 015 xxx..... 1-6
 R302 302 000..... 1-6
 R302 303 000..... 1-7
 R302 303 001..... 1-7
 R302 309 000..... 17-16

BNC HT-MHV

R316 004 000..... 15-8
 R316 007 000..... 15-8
 R316 011 000..... 15-8
 R316 020 010..... 15-8
 R316 072 000..... 15-8
 R316 072 010..... 15-8
 R316 207 000..... 15-8
 R316 211 000..... 15-8
 R316 257 000..... 15-8
 R316 261 000..... 15-8
 R316 405 000..... 15-9
 R316 553 000..... 15-9
 R316 603 000..... 15-9

R316 704 000.15-9, 16-9

R316 754 000.15-9, 16-9

SHV

R317 005 000..... 15-11
 R317 072 000..... 15-11
 R317 074 000..... 15-11
 R317 255 000..... 15-11
 R317 270 000..... 15-11
 R317 405 000..... 15-12
 R317 580 000..... 15-12
 R317 720 000..... 15-12,
 16-10

QRE

R324 054 L01..... 8-22
 R324 055 L00..... 8-22
 R324 195 L02..... 8-22
 R324 256 L01..... 8-22
 R324 434 L01..... 8-22
 R324 555 L01..... 8-23

2.4 MM

R327 052 000..... 10-22
 R327 052 202..... 10-22
 R327 222 000..... 10-22
 R327 222 200..... 10-22
 R327 316 000..... 10-22
 R327 316 010..... 10-22
 R327 411 000..... 10-23
 R327 430 000..... 10-23
 R327 465 000..... 10-23
 R327 556 000..... 10-22
 R327 703 000.10-24,16-9
 R327 704 000.10-24,16-9
 R327 705 000.10-24,16-9
 R327 771 000.10-24,16-9

THT 20

R331 018 000..... 15-13
 R331 168 000..... 15-13

R331 405 000..... 15-14

R331 603 000..... 15-14

MICROWAVE COMPONENT

R404 012 000..... 19-5
 R404 012 120..... 19-5
 R404 014 000..... 19-5
 R404 101 000..... 19-6
 R404 101 120..... 19-6
 R404 102 000..... 19-6
 R404 104 000..... 19-6
 R404 105 000..... 19-6
 R404 110 000..... 19-5
 R404 110 120..... 19-5
 R404 110 150..... 19-10
 R404 111 000..... 19-5
 R404 111 120..... 19-5
 R404 112 000..... 19-5
 R404 114 000..... 19-5
 R404 114 111..... 19-5
 R404 114 120..... 19-5
 R404 115 150..... 19-10
 R404 116 000..... 19-6
 R404 121 000..... 19-7
 R404 121 120..... 19-7
 R404 122 000..... 19-7
 R404 131 000..... 19-5
 R404 131 120..... 19-5
 R404 132 000..... 19-5
 R404 144 000..... 19-5
 R404 155 000..... 19-6
 R404 160 000..... 19-6
 R404 165 000..... 19-6
 R404 170 111..... 19-5
 R404 175 111..... 19-5
 R404 1D1 000 19-7
 R404 1D1 121 19-7
 R404 1D2 000 19-7
 R404 1D2 121 19-7
 R404 1D5 000 19-7
 R404 210 150..... 19-10

R404 211 150..... 19-10
 R404 215 150..... 19-10
 R404 216 150..... 19-10
 R404 225 000..... 19-7
 R404 225 120..... 19-7
 R404 240 000..... 19-5
 R404 240 120..... 19-5
 R404 240 121..... 19-5
 R404 245 000..... 19-5
 R404 260 000..... 19-7
 R404 262 000..... 19-7
 R404 270 000..... 19-5
 R404 275 000..... 19-5
 R404 280 000..... 19-6
 R404 280 150..... 19-10
 R404 285 000..... 19-6
 R404 285 150..... 19-10
 R404 340 000..... 19-5
 R404 340 120..... 19-5
 R404 350 150..... 19-10
 R404 355 000..... 19-5
 R404 355 150..... 19-10
 R404 370 000..... 19-7
 R404 370 120..... 19-7
 R404 370 150..... 19-10
 R404 375 000..... 19-7
 R404 375 150..... 19-10
 R404 380 000..... 19-7
 R404 412 000..... 19-5
 R404 441 000..... 19-5
 R404 441 120..... 19-5
 R404 441 121..... 19-5
 R404 442 000..... 19-5
 R404 442 120..... 19-5
 R404 505 000..... 19-7
 R404 506 000..... 19-8
 R404 507 000..... 19-8
 R404 510 000..... 19-7
 R404 516 000..... 19-8
 R404 517 000..... 19-8
 R404 522 000..... 19-8
 R404 555 000..... 19-7

Radiall part numbers

R404 556 000..... 19-8	R404 777 000..... 19-8	R410 1xx 121 19-13	R417 2xx 120 19-16
R404 557 000..... 19-8	R404 778 000..... 19-9	R410 2xx 121 19-13	R417 2xx 130 19-16
R404 560 000..... 19-7	R404 779 000..... 19-9	R411 7xx 124 19-12	R417 3xx 110 19-14
R404 564 000..... 19-7	R404 780 000..... 19-9	R411 8xx 119 19-12	R417 3xx 130 19-14
R404 566 000..... 19-8	R404 780 020..... 19-9	R411 8xx 121 19-12	R417 5xx 110 19-14
R404 567 000..... 19-8	R404 780 120..... 19-9	R411 8xx 124 19-12	R417 5xx 130 19-14
R404 571 000..... 19-8	R404 781 000..... 19-9	R412 3xx 124 19-12	R417 6xx 110 19-14
R404 572 000..... 19-8	R404 781 020..... 19-9	R412 4xx 000 19-12	R417 6xx 130 19-14
R404 585 000..... 19-8	R404 781 120..... 19-9	R412 4xx 124 19-12	R417 7xx 118 19-15
R404 585 500..... 19-8	R404 782 000..... 19-9	R412 5xx 000 19-13	R417 7xx 128 19-15
R404 586 000..... 19-8	R404 782 020..... 19-9	R412 5xx 124 19-13	R417 7xx 138 19-15
R404 586 500..... 19-8	R404 782 120..... 19-9	R412 700 124..... 19-12	R417 8xx 118 19-15
R404 587 000..... 19-8	R404 783 000..... 19-9	R412 7xx 000 19-12	R417 8xx 128 19-15
R404 587 500..... 19-8	R404 783 020..... 19-9	R412 8xx 000 19-12	R417 8xx 138 19-16
R404 588 000..... 19-8	R404 783 120..... 19-9	R413 2xx 150 19-17	R417 9xx 118 19-16
R404 588 500..... 19-8	R404 786 000..... 19-8	R413 3xx 000 19-13	R417 9xx 128 19-16
R404 600 000..... 19-6	R404 786 020..... 19-8	R413 3xx 150 19-17	R417 9xx 138 19-16
R404 605 000..... 19-6	R404 786 120..... 19-8	R413 8xx 000 19-13	R420 0xx 110 19-15
R404 750 000..... 19-8	R404 787 000..... 19-8	R413 8xx 115 19-13	R420 3xx 110 19-14
R404 751 000..... 19-8	R404 787 020..... 19-8	R413 8xx 121 19-13	R420 7xx 110 19-15
R404 752 000..... 19-8	R404 787 120..... 19-8	R413 8xx 150 19-17	R432 171 000..... 19-18
R404 753 000..... 19-8	R404 861 000..... 19-9	R414 4xx 150 19-17	R432 172 000..... 19-18
R404 756 000..... 19-7	R404 863 000..... 19-9	R414 5xx 000 19-13	R432 173 000..... 19-18
R404 758 000..... 19-8	R404 865 000..... 19-8	R414 5xx 150 19-17	R432 174 000..... 19-18
R404 759 000..... 19-8	R404 867 000..... 19-8	R414 5xx 161 19-13	R432 175 000..... 19-18
R404 760 000..... 19-9	R404 N01 000 19-6	R414 7xx 000 19-12	R432 271 000..... 19-18
R404 761 000..... 19-9	R404 N01 120 19-6	R414 7xx 150 19-17	R432 273 000..... 19-18
R404 762 000..... 19-9	R404 N01 121 19-6	R414 7xx 161 19-12	R432 274 000..... 19-18
R404 763 000..... 19-9	R404 N02 000 19-6	R415 3xx 000 19-14	R432 275 000..... 19-18
R404 764 000..... 19-9	R404 N03 000 19-6	R415 4xx 000 19-14	R432 371 000..... 19-18
R404 765 000..... 19-9	R404 N04 000 19-6	R415 5xx 000 19-14	R432 372 000..... 19-18
R404 766 000..... 19-8	R404 N05 000 19-6	R415 7xx 000 19-14	R432 373 000..... 19-18
R404 767 000..... 19-8	R404 N05 120 19-6	R416 0xx 000 19-14	R432 374 000..... 19-18
R404 768 000..... 19-9	R404 N05 121 19-6	R416 1xx 000 19-14	R432 375 000..... 19-18
R404 769 000..... 19-9	R404 N06 000 19-6	R416 8xx 000 19-14	R432 431 000..... 19-18
R404 770 000..... 19-9	R404 N07 000 19-6	R417 0xx 110 19-15	R432 432 000..... 19-18
R404 771 000..... 19-9	R404 N08 000 19-6	R417 0xx 120 19-15	R432 433 000..... 19-18
R404 772 000..... 19-9	R404 N61 000 19-7	R417 0xx 130 19-15	R432 434 000..... 19-18
R404 773 000..... 19-9	R404 N62 000 19-7	R417 1xx 110 19-15	R432 435 000..... 19-18
R404 774 000..... 19-9	R405 005 000..... 19-21	R417 1xx 120 19-15	R432 471 000..... 19-18
R404 775 000..... 19-9	R405 006 000..... 19-21	R417 1xx 130 19-16	R432 472 000..... 19-18
R404 776 000..... 19-8	R405 035 000..... 19-21	R417 2xx 110 19-16	R432 473 000..... 19-18

Radiall part numbers

R432 474 000..... 19-18	R443 131 000..... 19-22	R499 101 000..... 19-22	R694 251 025..... 4-8
R432 475 000..... 19-18	R443 134 000..... 19-22	R499 103 000..... 19-22	R694 251 026..... 4-8
R432 531 000..... 19-18	R443 137 000..... 19-22		R694 251 027..... 4-8
R432 533 000..... 19-18	R443 141 000..... 19-22	BR2	R694 251 111..... 4-9
R432 534 000..... 19-20	R443 151 000..... 19-22	R605 004 000..... 14-18	R694 251 112..... 4-9
R432 535 000..... 19-20	R443 162 000..... 19-22	R605 005 000..... 14-18	R694 251 113..... 4-9
R432 571 000..... 19-18	R443 171 000..... 19-22	R605 006 000..... 14-18	R694 251 114..... 4-9
R432 573 000..... 19-20	R443 191 000..... 19-22	R605 156 000..... 14-18	R694 251 115..... 4-9
R432 574 000..... 19-20	R443 530 000..... 19-22	R605 206 000..... 14-18	R694 251 116..... 4-9
R432 631 000..... 19-18	R443 533 000..... 19-22	R605 256 000..... 14-18	R694 251 117..... 4-9
R432 633 000..... 19-20	R443 533 480..... 19-22	R605 400 000..... 14-19	R694 252 101..... 4-7
R432 634 000..... 19-20	R443 536 000..... 19-22	R605 440 000..... 14-19	R694 252 102..... 4-7
R432 635 000..... 19-20	R447 120 000..... 19-21	R605 550 000..... 14-19	R694 252 103..... 4-7
R433 423 000..... 19-20	R447 171 000..... 19-21	R605 550 020..... 14-19	R694 252 104..... 4-7
R433 424 000..... 19-20	R451 030 000..... 19-21	R605 600 000..... 14-19	R694 252 105..... 4-7
R433 463 000..... 19-20	R451 030 500..... 19-21		R694 252 106..... 4-7
R433 464 000..... 19-20	R451 031 000..... 19-21	BANANAS	R694 252 107..... 4-7
R433 503 000..... 19-20	R451 031 500..... 19-21	R644 020 000..... 20-27	R694 252 507..... 4-13
R433 513 700..... 19-20	R451 032 000..... 19-21	R644 030 000..... 20-27	R694 252 537..... 4-13
R433 514 700..... 19-20	R451 032 500..... 19-21	R644 120 000..... 20-27	R694 252 557..... 4-13
R433 523 000..... 19-20	R451 033 000..... 19-21	R644 121 000..... 20-27	R694 261 076..... 4-11
R433 524 000..... 19-20	R451 033 500..... 19-21	R644 130 000..... 20-27	R694 261 906.4-10, 4-11
R433 563 000..... 19-20	R451 034 000..... 19-21	R644 131 000..... 20-27	R694 262 056..... 4-12
R433 564 000..... 19-20	R451 034 500..... 19-21	R644 543 000..... 20-26	R694 262 906..... 4-12
R433 611 700..... 19-18	R451 075 000..... 19-21	R644 543 001..... 20-26	R694 281 251..... 4-9
R433 612 700..... 19-20	R451 533 000..... 19-21	R644 543 002..... 20-26	R694 281 252..... 4-9
R433 613 700..... 19-20	R451 533 500..... 19-21	R644 543 003..... 20-26	R694 281 253..... 4-9
R433 614 700..... 19-20	R451 534 000..... 19-21	R644 543 004..... 20-26	R694 281 254..... 4-9
R433 623 000..... 19-20	R451 534 500..... 19-21	R644 543 020..... 20-26	R694 281 255..... 4-9
R433 624 000..... 19-20	R451 542 000..... 19-21	R644 543 021..... 20-26	R694 281 256..... 4-9
R433 663 000..... 19-20	R451 542 500..... 19-21	R644 543 022..... 20-26	R694 281 257..... 4-9
R433 664 000..... 19-20	R451 543 000..... 19-21	R644 543 023..... 20-26	BANANAS
R433 721 700..... 19-18	R451 543 500..... 19-21	R644 543 024..... 20-26	R921 019 000..... 20-23
R433 723 700..... 19-20	R451 544 000..... 19-21	R644 823 000..... 20-28	R921 029 000..... 20-23
R433 724 700..... 19-20	R451 544 500..... 19-21	R644 833 000..... 20-28	R921 119 000..... 20-23
R433 831 700..... 19-18	R451 570 000..... 19-21		R921 149 000..... 20-23
R433 832 700..... 19-20	R451 570 500..... 19-21	COAXIPACK 2	R921 330 000..... 20-23
R433 833 700..... 19-20	R451 572 120..... 19-21	R694 251 021..... 4-8	R921 331 000..... 20-23
R433 834 700..... 19-20	R451 574 000..... 19-21	R694 251 022..... 4-8	R921 332 000..... 20-23
R435 170 000..... 19-22	R451 574 500..... 19-21	R694 251 023..... 4-8	R921 333 000..... 20-23
R435 270 000..... 19-22	R451 576 000..... 19-21	R694 251 024..... 4-8	R921 334 000..... 20-23
R435 470 000..... 19-22	R451 576 500..... 19-21		

Radiall part numbers

R921 336 000..... 20-23	R929 991 003..... 20-26	R941 920 600..... 20-11
R921 390 000..... 20-30	R929 991 004..... 20-26	R941 920 602 20-11
R921 391 000..... 20-30	R929 992 000..... 20-26	R941 920 603..... 20-11
R921 461 000..... 20-23	R929 993 000..... 20-26	R941 921 001..... 20-15
R921 609 000..... 20-24	R929 993 001..... 20-26	R941 921 600..... 20-11
R921 629 000..... 20-24	R929 993 002..... 20-26	R941 921 602..... 20-11
R921 820 070..... 20-28	R929 993 003..... 20-26	R941 921 603..... 20-11
R921 820 071..... 20-28	R929 993 004..... 20-26	R941 922 001..... 20-15
R921 820 072..... 20-28	R929 994 003..... 20-26	R941 922 600..... 20-11
R921 820 073..... 20-28	R941 019 000..... 20-14	R941 923 001..... 20-15
R921 820 074..... 20-28	R941 029 000..... 20-14	R941 923 600..... 20-11
R921 820 076..... 20-28	R941 049 000..... 20-14	R941 924 001..... 20-15
R921 850 000..... 20-28	R941 069 000..... 20-14	R941 924 600..... 20-11
R921 851 000..... 20-28	R941 149 000..... 20-14	R941 924 603..... 20-11
R921 910 000..... 20-28	R941 330 000..... 20-15	R941 926 001..... 20-15
R921 911 000..... 20-28	R941 331 000..... 20-15	R941 960 600..... 20-18
R921 912 000..... 20-28	R941 332 000..... 20-15	R941 961 600..... 20-18
R921 913 000..... 20-28	R941 333 000..... 20-15	R948 1xx 6xx..... 20-12
R921 914 000..... 20-28	R941 334 000..... 20-15	R948 3xx 6xx..... 20-12
R921 920 000..... 20-24	R941 336 000..... 20-15	R948 0xx 000 20-16
R921 921 000..... 20-24	R941 340 000..... 20-15	
R921 922 000..... 20-24	R941 341 000..... 20-15	
R921 923 000..... 20-24	R941 342 000..... 20-15	
R921 924 000..... 20-24	R941 343 000..... 20-15	
R921 926 000..... 20-24	R941 344 000..... 20-15	
R921 930 000..... 20-24	R941 346 000..... 20-15	
R921 931 000..... 20-24	R941 460 000..... 20-15	
R921 932 000..... 20-24	R941 460 600..... 20-15	
R921 933 000..... 20-24	R941 461 000..... 20-15	
R921 934 000..... 20-24	R941 461 600..... 20-10	
R921 936 000..... 20-24	R941 462 600..... 20-10	
R928 0xx 000 20-25	R941 463 600..... 20-10	
R928 1xx 000 20-25	R941 464 600..... 20-10	
R929 000..... 20-25	R941 480 600..... 20-10	
R929 001..... 20-25	R941 481 600..... 20-10	
R929 100..... 20-25	R941 619 000..... 20-15	
R929 101..... 20-25	R941 629 000..... 20-15	
R929 500..... 20-25	R941 850 000..... 20-18	
R929 501..... 20-25	R941 850 600..... 20-18	
R929 991 000..... 20-26	R941 851 000..... 20-18	
R929 991 001..... 20-26	R941 851 600..... 20-18	
R929 991 002..... 20-26	R941 920 001..... 20-15	

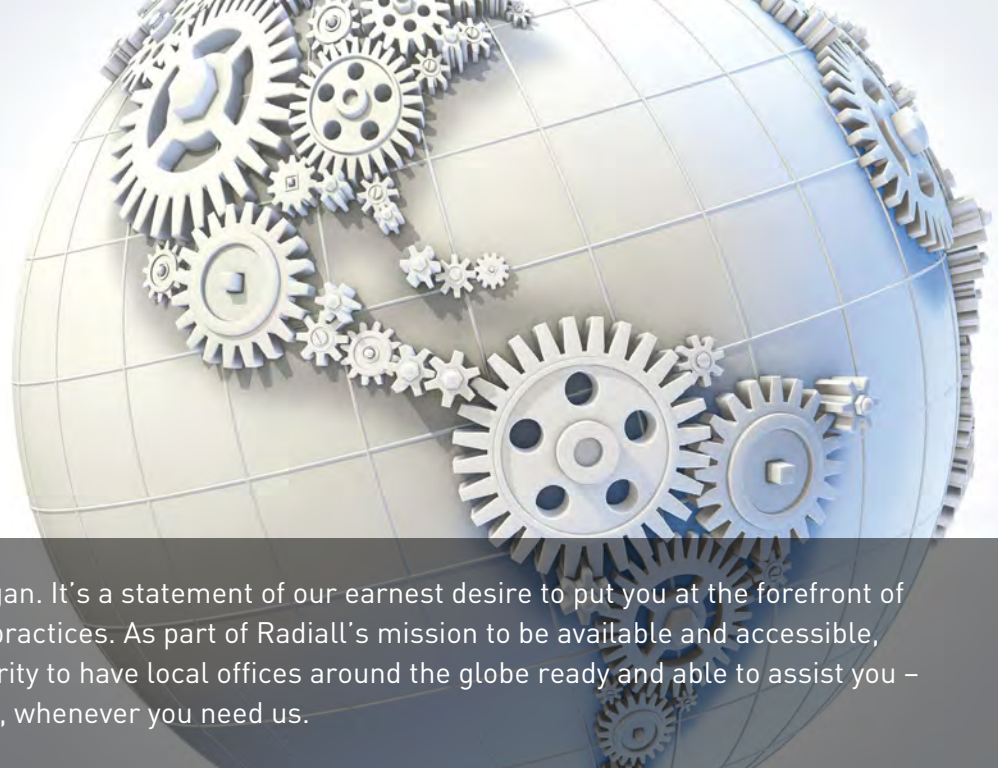

Our most
important
connection
is with you.™

It's not just a slogan. It's a statement of our earnest desire to put you at the forefront of all our business practices. As part of Radiall's mission to be available and accessible, we make it a priority to have local offices around the globe ready and able to assist you – wherever you are, whenever you need us.

Europe

	ADDRESS	PHONE	FAX	EMAIL
FINLAND	Radiall Finland PO Box 202 - 90101 Oulu	+358 407522412		infofi@radiall.com
FRANCE	Radiall SA 25 Rue Madeleine Vionnet - 93300 Aubervilliers	+33 (0)1 49 35 35 35		info@radiall.com
GERMANY	Radiall GmbH Carl-Zeiss Str. 10 - D 63322 Rödermark	+49 60 74 91 07 0	+49 60 74 91 07 10	infode@radiall.com
ITALY	Radiall Elettronica S.R.L Via Della Resistenza 113 - 20090 Buccinasco Milano	+39 02 48 85 121	+39 02 48 84 30 18	infoit@radiall.com
NETHERLANDS	Radiall Nederland BV Hogebrinkerweg 15b - 3871 KM Hoevelaken	+31 (0)33 253 40 09	+31 (0)33 253 45 12	infofl@radiall.com
SWEDEN	Radiall AB Sollentunavägen 63 - 191 40 Sollentuna	+46 8 444 34 10		infose@radiall.com
UNITED KINGDOM	Radiall Ltd Profile West 950 Great West Rd Brentford, Middlesex TW8 9ES	+44 (0)1895 425000	+44 (0)1895 425010	infofk@radiall.com

Asia

	ADDRESS	PHONE	FAX	EMAIL
CHINA	Shanghai Radiall Electronics CO, Ltd N° 390 Yong He Rd SHANGHAI 200072 P.R.C	+86 21 66523788	+86 21 66521177	infozh@radiall.com
HONG KONG	Radiall Electronics (Asia) Ltd Flat D, 6/F, Ford Glory Plaza, 37-39 Wing Hong Street - Cheung Sha Wan - Kowloon - Hong Kong	+852 29593833	+852 29592636	infohk@radiall.com
INDIA	Radiall India Pvt. Ltd 25.D.II phase Peenya Industrial Area. Bangalore-560058	+91 80 283 95 271	+91 80 283 97 228	infoin@radiall.com
JAPAN	Nihon Radiall K.K. 8F, Sawada building, 3-22-8 Higashi Shibuya-ku Tokyo 150-0013	03 (6427) 4455	03 (6427) 4456	infojp@radiall.com

Americas

	ADDRESS	PHONE	FAX	EMAIL
USA & CANADA	Radiall USA, Inc. 8950 South 52nd Street Ste 401 Tempe, AZ 85284	+1 480-682-9400	+1 480-682-9403	infousa@radiall.com

Also Represented In...

AUSTRALIA AUSTRIA BELGIUM BRAZIL CZECH REPUBLIC DENMARK ESTONIA GREECE HUNGARY INDONESIA ISRAEL KOREA LATVIA LITHUANIA
MALAYSIA NORWAY PHILIPPINES POLAND PORTUGAL RUSSIA SINGAPORE SPAIN SWITZERLAND TAIWAN THAILAND VIETNAM SOUTH AFRICA