



Coaxipack 2

R694



Australian Representatives

ROJONE, PTY LTD.

Tel: 02 9829 1555

E: sales@rojone.com.au

www.rojone.com.au



Contents

COAXIPACK 2

Introduction 4-4 to 4-5

Characteristics 4-6

PCB modules 4-7 to 4-9

Feedthrough male cable assembly 4-10

Feedthrough male male adapter kits 4-11

Cable assembly 4-12 - 4-13

Samples and guide pins 4-14

Extraction procedures 4-15

SECTION 4 TABLE OF CONTENTS

Introduction

The Coaxipack 2 series has been designed in accordance with the IEC 61076-4-104 (standard 2mm geometry system). Coaxipack 2 provides high density coaxial connectors aimed at high speed and space saving applications. The Coaxipack 2 series is available in 50Ω and 75Ω.

APPLICATIONS

50Ω RANGE

- Telecom / Datacom (Transmission equipment, Satellite Communication Systems, Base station)
- Medical
- Networking industry
- Instrumentation

75Ω RANGE

- High speed data network
- Digital Broadcast System (Routers, Switching and Control Systems, Monitoring and Signal Measurement, Encoders etc...)

FEATURES AND BENEFITS

Coaxipack 2 combines high performance miniature coaxial connectors with the convenience, compacity and cost effectiveness of 2mm metric systems.

FEATURES

- Excellent for coaxial signal transmission: low crosstalk, low signal distortion, high level of EMI/RFI shielding
- High speed performance: Minimum reflection and propagation delay, sub-nanosecond rise time capabilities
- Ruggedized for a variety environments: Industrial applications, humidity, shock, vibration...

BENEFITS

- Space savings on PCB, reduced PCB routing complexity and supplies adequate spacing for high speed routing.
- Stackable with other 2mm metric modules (ex: power, signal) from most manufacturers.
- Maximum flexibility in system architecture due to Coaxipack's modular design-system designers are able to upgrade designs and add new functions without having to adopt major changes in the hardware configuration.

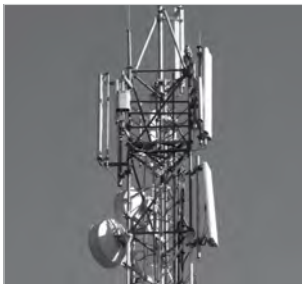
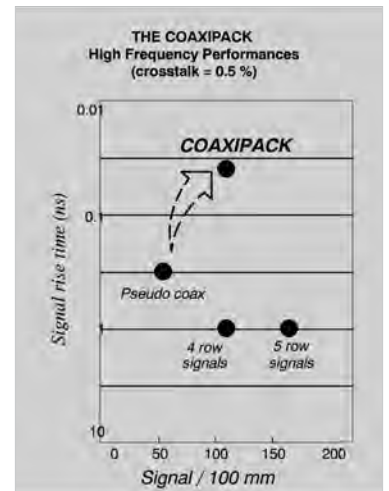

Introduction

MODULE

- Radiall offers a large range of pre-assembled modules. The term "module" is used for Coaxipack 2 connector mounting on board configuration.
- One module combines a housing including one or more inserts. The number of inserts depends on the required configuration, up to 6 contacts.



- Depending on the part number, one insert is made of one or two coaxial contacts.



CABLE ASSEMBLIES

Radiall offers a standard kit including straight female insert and housing which fully complies with the IEC 61076-4-104.

TECHNOLOGY BREAKTHROUGH INNOVATION

- **Interface:** Robust guidance and mating tolerances with reinforced interface provides a perfect alignment without any risk of loss of contact.
 - Male: New chamfers on outer contact and new radius on center contact for improved guidance
 - Female: New chamfered and extended insulator prevents any misalignment in very high density applications
- **Packaging:** Improved design of packaging to secure the connectors and prevent any damage during the transportation or handling. All connectors are shipped in a tray for safety during transportation and an added convenience during the manufacturing process.

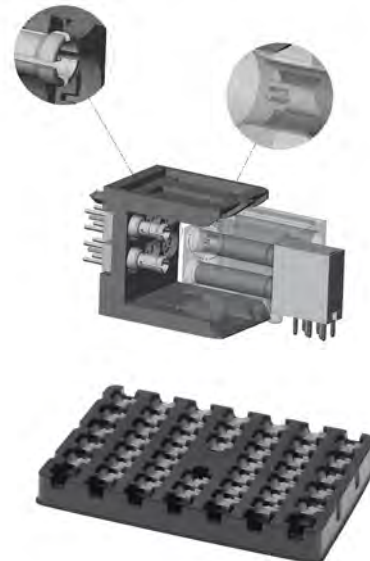

ORDERING GUIDE

- **Connector choice**
Radiall offers either ready to use modules (housing + inserts) or ca
- **Shielded connectors**
Additional choices with two ways of plating to improve the shielding level:
 - (1) Addition of metal plates to the plastic housing
 - (2) Metallization of the plastic housing

Characteristics

ELECTRICAL CHARACTERISTICS

Frequency range	DC-3 GHz (Optimized) - (Working range up to 6 GHz)	
Impedance	50Ω and 75Ω	
V.S.W.R mated pair for <ul style="list-style-type: none"> • PCB modules • Straight female - cable assembly • Straight male - cable assembly 	DC-1 GHz < 1.08 < 1.15 < 1.13	1-3 GHz < 1.12 < 1.30 < 1.20
Insertion loss mated pair	0.2 dB typical from 0 to 3 GHz	
RF leakage	-35 dB at 3 GHz	
Voltage rating	500 V	
Dielectric withstanding voltage	750 V	
Insulation resistance	≥ 5000 MΩ	
Contact resistance <ul style="list-style-type: none"> • Center contact • Outer contact 	Initial	After environment test
	< 5 mΩ	< 15 mΩ
	< 2.5 mΩ	< 7.5 mΩ
Rise time degradation (corrected for board effects) at 300ps	6 ps	
Difference in propagation delay between shortest and longest line	26 ps	
Near end crosstalk at 300ps	0.2 %	

MECHANICAL CHARACTERISTICS

Mating cycles	500
Insertion force	2.5 N
Extraction force	2.2 N
Contact density	2 to 6 contacts per module 60 contacts per 120 mm x 16 mm

ENVIRONMENTAL CHARACTERISTICS

Temperature range	-25 / +125°C
-------------------	--------------

MATERIALS

Housing	Liquid Crystal Polymer (LCP) glass filled
Bodies & contacts	Brass or bronze (see technical data sheet for details)
Insulators	PTFE / PEEK
Spring contacts	Beryllium copper

PLATING

Coaxial contacts	NPGR
------------------	------

PCB modules

RIGHT ANGLE FEMALE PCB MODULES (50Ω)

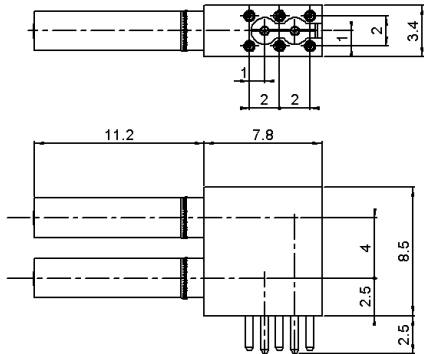
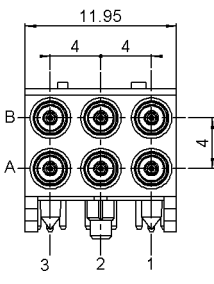
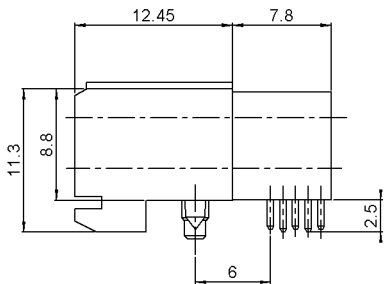
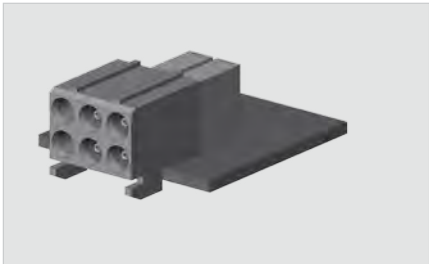
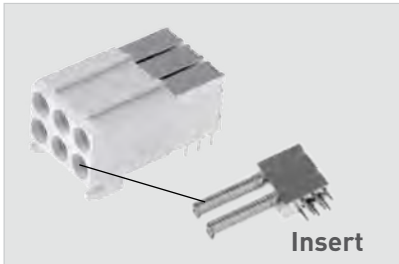

Recommended PCB thickness: 1.6 mm

Insert
(not sold separately)

Number of contacts	Position	Part number	Packaging (pieces/tray)
2		R694 252 101	50
		R694 252 102	
		R694 252 103	
4		R694 252 104	
		R694 252 105	
		R694 252 106	
6		R694 252 107	

COAXIPACK 2

PCB modules

STRAIGHT MALE PCB MODULES (50Ω)

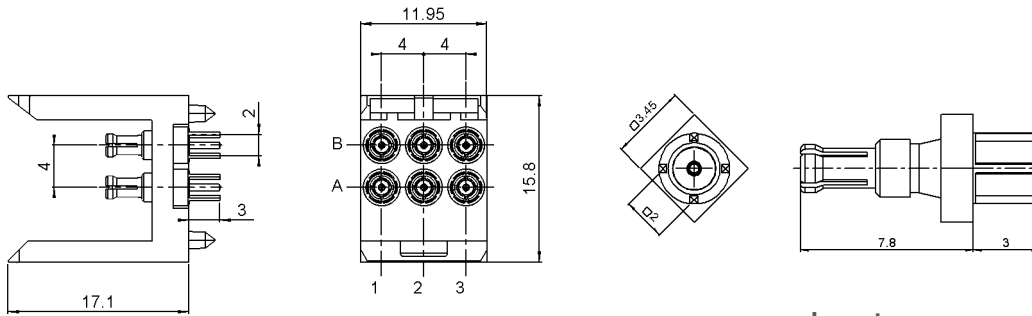
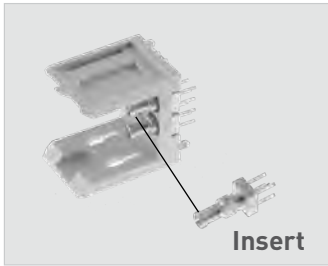

Recommended PCB thickness: 2 mm max

Insert
(not sold separately)

Number of contacts	Position	Part number	Packaging (pieces/tray)
2		R694 251 021	50
		R694 251 022	
		R694 251 023	
4		R694 251 024	
		R694 251 025	
		R694 251 026	
6		R694 251 027	

PCB modules

RIGHT ANGLE MALE PCB MODULES (50Ω and 75Ω)

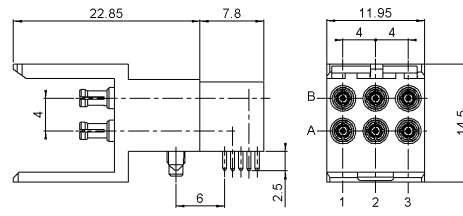
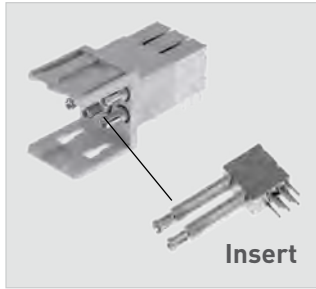

Recommended PCB thickness for 50Ω: 1.6 mm
for 75Ω: 2.4 mm

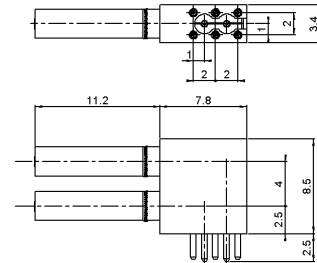

Insert
(not sold separately)

50Ω					
Number of contacts	Position of insert	Part number ⁽¹⁾	Dimension a (mm)	Extraction procedure	Packaging (pieces/tray)
2		R694 251 111	2.5	U01	25
		R694 251 112			
		R694 251 113			
4		R694 251 114			
		R694 251 115			
		R694 251 116			
6		R694 251 117			

75Ω					
Number of contacts	Position of insert	Part number ⁽²⁾	Dimension a (mm)	Extraction procedure	Packaging (pieces/tray)
2		R694 281 251	3.3	U01	25
		R694 281 252			
		R694 281 253			
4		R694 281 254			
		R694 281 255			
		R694 281 256			
6		R694 281 257			

Note

⁽¹⁾ Housing is available in shielded version. For specific request, please consult sales

⁽²⁾ With shielded version.

COAXIPACK 2

Our Most Important Connection is with You.™

Feedthrough male cable assembly



STRAIGHT MALE HOUSING

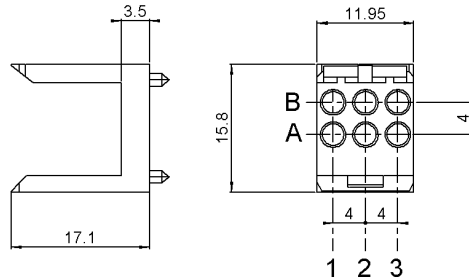
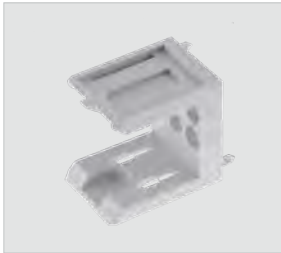

Part number	Note
R694 261 906	For removable inserts (not included)

STRAIGHT MALE REMOVABLE INSERTS, FULL CRIMP TYPE

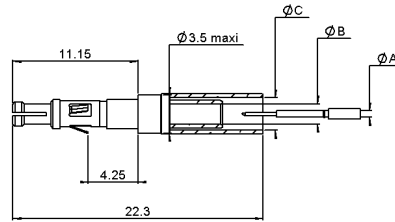

Cable group	Cable group dia.	Part number	Dimensions (mm)			Recommended PCB thickness (mm)	Extraction procedure
			A	B	C		
RG 178	2/50/S	R199 001 203	0.4	1	2.55	3.2 ± 0.1	U01
RG 174	2.6/50/S	R199 001 223	0.6	1.8	2.92	3.2 ± 0.1	

7 different possible configurations

2 Inserts			4 Inserts			6 Inserts

Feedthrough male male adapter kits



FOR REMOVABLE INSERT (50Ω)

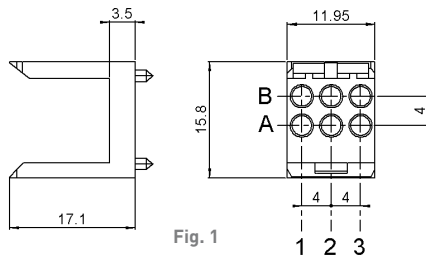

Fig. 1

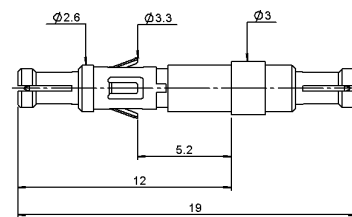

Fig. 2

Designation	Part number	Fig.	Panel thickness (mm)	Extraction procedure
Housing	R694 261 906 ⁽¹⁾	1		
Male male insert	R199 001 733	2	3.2 ± 0.05	U01

FOR NON REMOVABLE INSERT (50Ω)

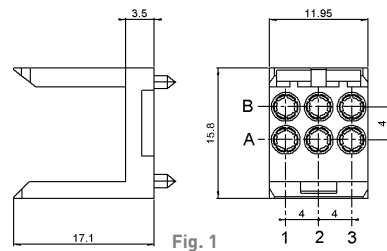

Fig. 1

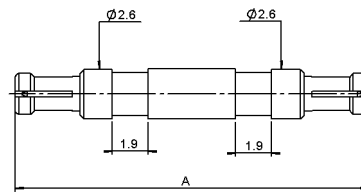

Fig. 2

Designation	Part number	Fig.	Dimension A (mm)	Panel thickness (mm)
Housing	R694 261 076 ⁽¹⁾	1		
Non removable insert ⁽²⁾	R199 001 703	2	18	2 ± 0.1
	R199 001 713		18.6	2.4 ± 0.2

Note

⁽¹⁾ Kits including housing and inserts are available. Please consult sales.

⁽²⁾ Other length and PCB thickness available upon request: please consult sales.

Cable assembly

Each cable assembly consists of:

- One housing
- One cover
- One latch
- One or several inserts corresponding to customer's configuration

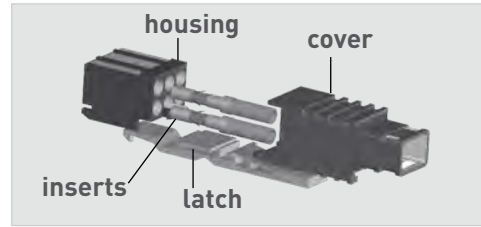

HOUSING Two types of housing for straight female cable assembly kit are offered:

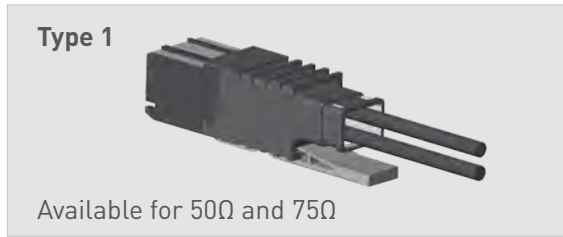

Type 1: HOUSING FOR FEMALE INSERTS

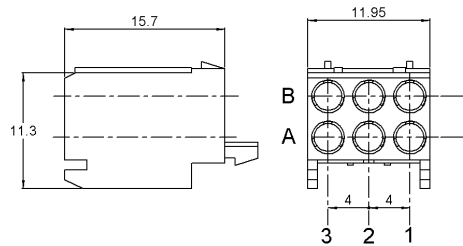

Part number
R694 262 056

Straight inserts (see page 5-14)
for 50Ω: **R199 001 003** or **R199 001 023**
for 75Ω: **R199 001 053**

Type 2: HOUSING FOR FEMALE INSERTS WITH PRESS - IN FIXING STUD (for panel and PCB mounting)

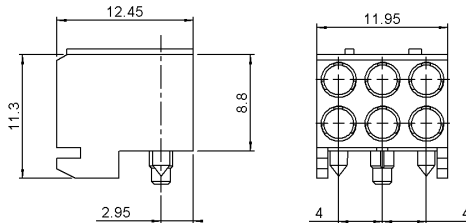

Part number
R694 262 906

Straight inserts (see page 5-14)
for 50Ω: **R199 001 003** or **R199 001 023**
for 75Ω: **R199 001 053**

COVER (type 1 only)

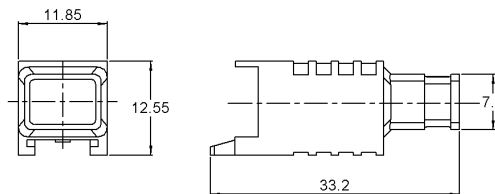

Part number
R280 420 010

Cable assembly

LATCH (type 1 only)

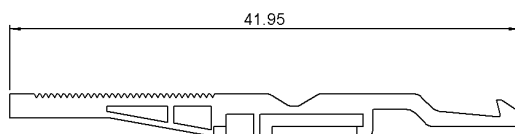
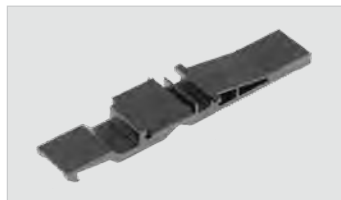

Part number
R280 420 030

KIT: COVER + FEMALE HOUSING + LATCH (type 1 only)

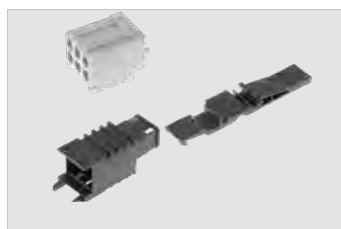

Part number	Composed of
R280 420 058	R694 262 056 + R280 420 010 + R280 420 030

STRAIGHT FEMALE REMOVABLE INSERTS, FULL CRIMP TYPE (type 1 and 2)

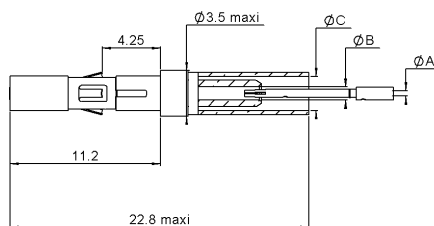

Impedance	Cable group	Cable group dia.	Part number	Dimensions (mm)			Extraction procedure	Packaging
				A	B	C		
50Ω	RG 178	2/50/S	R199 001 003	0.4	1	2.55	U02	100 pieces
	RG 174	2.6/50/S	R199 001 023	0.6	1.7	2.92		
75Ω		2.5/75/D	R199 001 053	0.4	1.2	2.95		

COMPLETE CABLE ASSEMBLY KIT (non assembled)

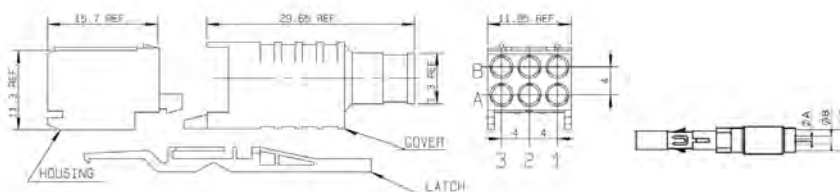
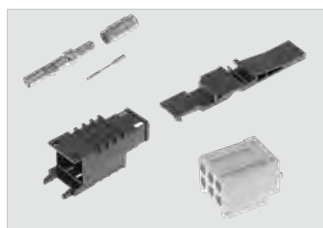

include housing + latch+ 6 contacts + cover (cable not included)

Impedance	Cable group	Cable group dia.	Part number	Position	Dimensions (mm)			Extraction procedure	Packaging
					A	B	C		
50Ω	RG 178	2/50/S	R694 252 507		0.4	1	2.55	U02	30 pieces
	RG 174	2.6/50/S	R694 252 537		0.6	1.7	2.92		
75Ω		2.5/75/D	R694 252 557		0.4	1.2	2.95		

Samples and guide pins

SAMPLE PIGTAIL



Part number	Position	Designation	Note
R284 906 002		20 cm pigtail	Can be used with demonstration board R299 400 020

STANDARD SAMPLE CABLE ASSEMBLY



Part number	Position	Designation
R284C0431006		Coaxipack cable assembly 15 cm

STANDARD SAMPLE CABLE ASSEMBLY (equipped with female coaxial inserts)

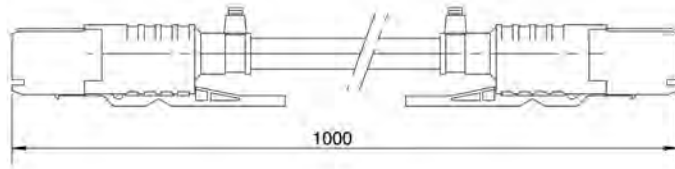

Cable group	Cable group dia.	Part number	Extraction procedure
RG 174	2.6/50/S	R285 930 005	U02

Special configuration are available upon request. Please consult sales.

GUIDE PINS

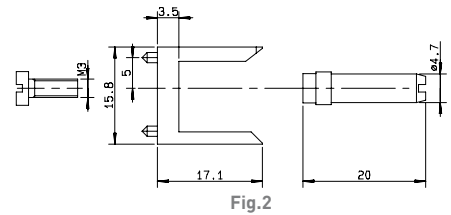
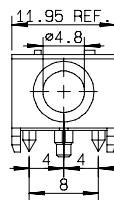
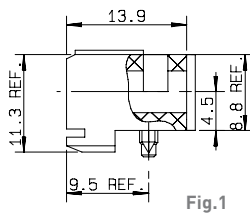

Part number	Fig.	Designation
R280 420 300	1	Female housing for guide pin
R280 420 200	2	Kit = Male housing + guide pin + screw

⁽¹⁾ Other guide pin length available upon request. Please consult sales.

Extraction procedures

U01 HOW TO USE TOOL R282 920 010

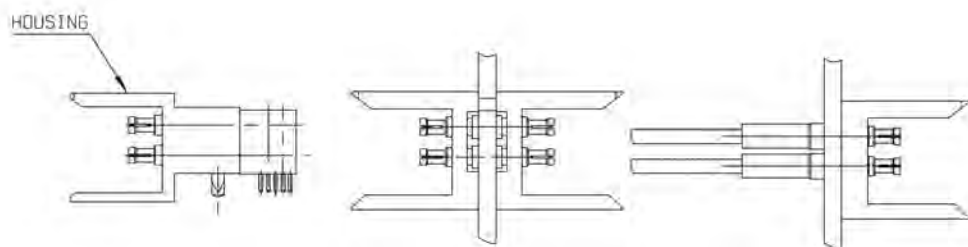

Inserts	Pre-assembled modules	
R199 001 203 R199 001 223 R199 001 733	R694 251 111 R694 251 112 R694 251 113 R694 251 114	R694 251 115 R694 251 116 R694 251 117

- Place the extraction tool as shown (upper coaxial contact only for twin coax) and push in axial direction into the housing until it stops.
- Then press gently on the rod to remove the contact from the rear of the housing.

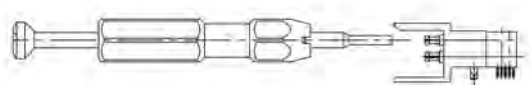

U02 HOW TO USE TOOL R282 920 100

Kits	Inserts
R285 930 005 R694 252 507 R694 252 537 R694 252 557	R199 001 003 R199 001 023 R199 001 053

- Use a screw-driver to remove the cover from the housing as shown.
- Slide the cover along the cable.
- Place the extraction tool (as shown) and push in axial direction into the housing until it stops.
- Then press gently on the piston to remove the contact from the rear of the housing.

