

Pasternack

RF Product Guide 2019

Waveguides



Australian Representatives
ROJONE, PTY LTD.
Tel: 02 9829 1555
E: sales@rojone.com.au
www.rojone.com.au

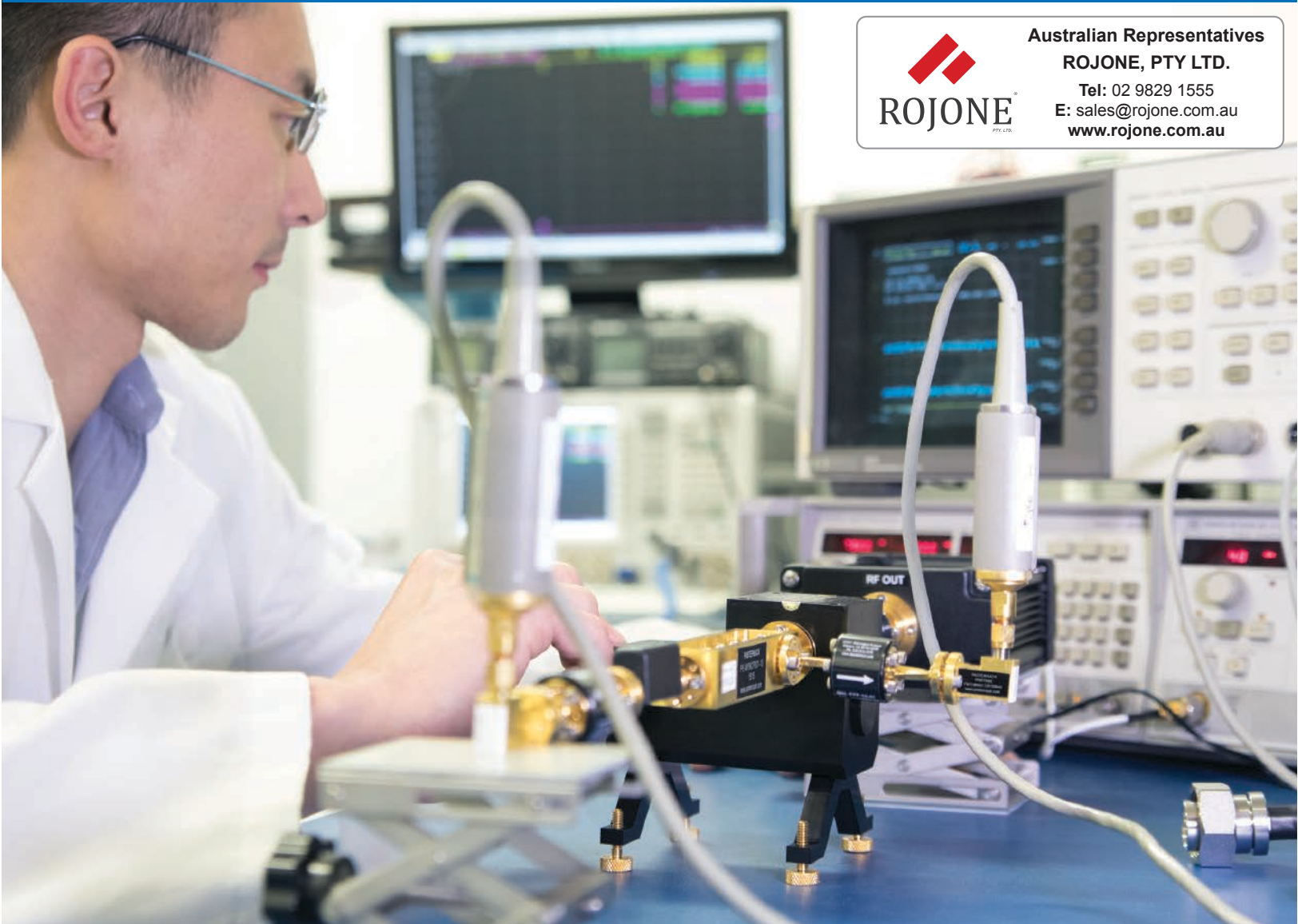

Largest Selection ✓ Same-Day Shipping ✓ Expert Technical Support ✓

866.727.8376 | sales@pasternack.com

PE PASTERNAK®
THE ENGINEER'S RF SOURCE

INDEX GUIDE TO WAVEGUIDE PRODUCTS

WAVEGUIDE ANTENNAS.....220

GAIN HORNS.....220 **GAIN HORNS WITH COAX.....220** **SPECIALTY WG ANTENNAS.....222**

Pasternack offers a large selection of waveguide antennas from WR-284 to WR-15 (2.6 GHz to 75 GHz) in a variety of flanges and gain. Both UG and CPR/CMR style flanges are available. Most of the gain horn antennas can be purchased already assembled with a waveguide to coax adapter.



WAVEGUIDE BENDS.....222



Pasternack offers a selection of E and H plane waveguide bends of various flanges and interfaces, covering the frequency range from 5.85 GHz to 18 GHz with VSWR as low as 1.08:1.

WAVEGUIDE FILTERS.....222

BANDPASS.....222

Pasternack offers a selection of high performance waveguide bandpass filters, covering the frequency range from 20.2 GHz to 40 GHz with WR-28 and WR-42 interfaces. These filters exhibit excellent out-of-band rejection making them ideally suited to receiver front-end or transmitter applications.



WAVEGUIDE BULKHEAD ADAPTERS.....223



The Pasternack series of rectangular waveguide bulkhead flange mount adapters are mounted to the panel of equipment with screws. Once mounted, waveguides flanges can be attached to the adapter on both sides of the bulkhead adapter to allow a signal path through the panel.

WAVEGUIDE CONVERTERS.....224

MIXER DOWN CONVERTERS.....224 **MIXER UP CONVERTERS.....224**

Pasternack offers a series of Millimeter Wave Up and Down Converter Mixers that cover popular Ka, Q, U, V, E, and W Bands up to 110 GHz with an IF frequency of DC to 18 GHz. L and R ports support popular waveguide sizes from WR-28 to WR-10, and the IF port utilize Female SMA connectors.



WAVEGUIDE COUPLERS.....225

ASSEMBLIES.....227 **BROADWALL.....225** **CROSSGUIDE.....226**



Pasternack offers a brand new family of instrumentation grade directional waveguide couplers boasting accurate performance up to 110 GHz in seven popular frequency bands including K, Ka, Q, U, V, E and W bands. These waveguide couplers boast high directivity of 30 dB typical and insertion loss is as low as 0.6 dB in some models.

WAVEGUIDE DETECTORS.....228

ZERO BIASED DETECTORS.....228

Waveguide detectors consists of 6 unique models covering a broad frequency range of 26.5 GHz to 110 GHz. The input ports use popular waveguide sizes ranging from WR-28 to WR-10, while the video output ports utilize SMA female connectors. The detector circuits use high performance GaAs Schottky Barrier Beam lead diodes with extremely low junction capacitance.



WAVEGUIDE DIRECT READ ATTENUATORS.....228



These continuously variable attenuators have "direct read" capability which allows the user to dial-in the amount of attenuation needed to within 2% accuracy over most of the attenuation range. The attenuation level is stable, highly repeatable and accurate across the full frequency and attenuation range. These attenuators are ideal for precision measurements in demanding applications like instrumentation and system calibration.

WAVEGUIDE ELECTROMECHANICAL RELAY SWITCHES.....228

Pasternack offers a series of 28 waveguide electromechanical relay switch models that offer full waveguide performance covering C, X, Ku, K and Ka frequency bands from 5.85 GHz 40 GHz. These switches re configured for single-pole double-throw (SPDT) operation with latching self-cut-off actuators, TTL logic and position indicators with manual override.



FLEXIBLE WAVEGUIDES.....229

SEAMLESS.....229

TWISTABLE.....230

This family of flexible, seamless waveguides or flexible, twistable waveguides that can be bent in both the E and H planes without impairing VSWR or attenuation. These waveguides are covered by a neoprene jacket which protect the waveguide and provides mechanical support.



WAVEGUIDE GUNN OSCILLATORS.....231



Waveguide Gunn Oscillators consist of 2 models that have center frequencies of 24.125 GHz and 35 GHz. Both models are tunable and supply output power levels of +10 dBm min. Compact package outlines support WR-28 and WR-42 waveguide sizes.

WAVEGUIDE MAGIC TEES.....231

Pasternack's magic, or hybrid tees are 4 port device that is internally tuned to optimize matching, balance, and isolation. A signal applied to the H port will be equally divided between the two collinear ports. A signal applied to the E port will be divided between the two collinear ports but with a 180 degree phase difference. Similarly, when two in-phase signals of equal amplitude are applied to the collinear ports, these will be added together at the H-plane (sum) port and subtracted from one another at the E-plane (difference) port.



WAVEGUIDE PHASE SHIFTERS.....232



These waveguide variable phase shifters are built using low loss dielectric material, which offers minimum insertion loss. They are equipped with micrometer, which allows fine control resulting in accurate and repeatable phase settings. The variable phase shifters are typically used in the test setups and prototype assemblies where accurate phase shifting is required.

WAVEGUIDE PIN DIODE SWITCHES.....232

Waveguide PIN Diode Switches consist of 4 models that cover 60 GHz to 110 GHz, in both SPST and SPDT configurations. Compact packages support WR-10 and WR12 waveguide sizes and SMA Female control connectors. All designs incorporate TTL-Compatible driver circuitry.



WAVEGUIDE POWER AMPLIFIERS.....232



Waveguide Power Amplifiers consist of 2 models that cover 70.5 GHz to 86.5 GHz (E Band) and support WR-12 waveguide ports. Performance includes small signal gain that ranges from 20 to 22 dB.

WAVEGUIDE SECTIONS.....233

Pasternack offers a standard product line of waveguide straight section of various length and flanges, covering the frequency range from 5.85 GHz to 12.4 GHz with VSWR as low as 1.03:1.



WAVEGUIDE TO COAX ADAPTERS.....235 WAVEGUIDE TRANSITIONS.....237



Grooved waveguide to coax adapters have CPR-XXXG flanges with an o-ring groove that will accept an o-ring seal. These adapters have right angle launch Type N connectors and cover frequencies from 1.7 GHz to 12.4 GHz.



Pasternack's family of Waveguide Transitions (also sometimes called waveguide adapters) are used as a means of propagating RF/Microwave energy from one waveguide size to another.

GROOVED FLANGES.....235 STANDARD FLANGES.....235 WAVEGUIDE TWISTS.....238

Standard waveguide to coax adapters are available in right angle launch and end launch versions. These adapters are available in 15 different waveguide sizes, operating at frequencies from 1.7 GHz to 40 GHz.



Pasternack offers waveguide twists in 45 degree left and right hand waveguide versions as well at 90 degree. These twists are designed and constructed to prevent unwanted distortion to the signal's transmission.



WAVEGUIDE TERMINATIONS.....234 WAVEGUIDE VARIABLE ATTEN.....239



Pasternack has a large family of high performance loads from WR-112 to WR-10. These standard terminations can dissipate up to 300 Watts of power depending on the specific band.



The Continuously Variable attenuators are equipped with a micrometer, which enables rapid re-setting. With calibrated charts, attenuators can be used as direct reading attenuator for bench top test set use.



Free Shipping Available
via UPS Ground
to USA & Canada



Technical
Support
(866) 727-8376



Same-Day Shipping,
Even Custom
Cable Assemblies

WAVEGUIDE ANTENNAS

Gain Horns

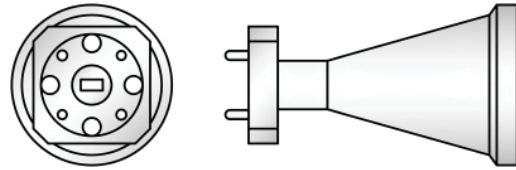

Waveguide Type	RF Frequency (GHz.)	Gain (dB)	Flange Type	ECCN	Model No	1 Pc. Price	See Web for Volume Pricing	ROW												
WR-15	50 - 75	24	Round Cover	5A991	PE9881-24	\$1,294.23	See Web for Volume Pricing	1												
		10		EAR99	PE9850-10	\$801.61		2												
		15		EAR99	PE9850-15	\$862.12		3												
20	EAR99	PE9850-20	\$907.48	4																
WR-28	26.5 - 40	10	Square Cover	EAR99	PE9851-10	\$809.17		5												
		15		EAR99	PE9851A-15	\$870.25		6												
		20		EAR99	PE9851A-20	\$890.36		7												
10	EAR99	PE9852-10		\$801.61	8															
WR-34	22 - 33	15		Square Cover	EAR99	PE9852A-15		\$813.32	9											
		20			EAR99	PE9852-20		\$941.63	10											
		10			EAR99	PE9853-10		\$756.23	11											
WR-42	18 - 26.5	15			Square Cover	EAR99		PE9853-15	\$870.25	12										
		20				EAR99		PE9853-20	\$856.11	13										
		10				EAR99		PE9853A-20	\$856.11	14										
WR-51	15 - 22	10				Square Cover		EAR99	PE9854-10	\$763.37	15									
		15						EAR99	PE9854-15	\$795.63	16									
		20						EAR99	PE9854-20	\$840.71	17									
WR-62	12.4 - 18	10						Square Cover	EAR99	PE9855-10	\$763.37	18								
		15							EAR99	PE9855-15	\$809.17	19								
		20							EAR99	PE9855A-20	\$799.07	20								
WR-75	10 - 15	10							Square Cover	EAR99	PE9856-10	\$713.43	21							
		15								EAR99	PE9856-15	\$809.17	22							
		20								EAR99	PE9856-20	\$892.59	23							
WR-90	8.2 - 12.4	10								Square Cover	EAR99	PE9857-10	\$809.17	24						
		15									EAR99	PE9857-15	\$813.32	25						
		20									EAR99	PE9857-20	\$856.11	26						
WR-102	7 - 11	10									Square Cover	EAR99	PE9858-10	\$809.17	27					
		15										EAR99	PE9858-15	\$870.25	28					
		20										EAR99	PE9858A-20	\$890.36	29					
WR-112	7.05 - 10	10										Square Cover	EAR99	PE9859-10	\$756.23	30				
		15											EAR99	PE9859-15	\$805.59	31				
		20											EAR99	PE9859-20	\$856.11	32				
WR-137	5.85 - 8.2	10											CMR-137	EAR99	PE9860-10	\$880.38	33			
		15												EAR99	PE9860-15	\$946.53	34			
		20												EAR99	PE9860-20	\$955.96	35			
WR-159	4.9 - 7.05	10												CMR-159	EAR99	PE9861-10	\$856.11	36		
		15													EAR99	PE9861-15	\$1,017.30	37		
		20													EAR99	PE9861-20	\$1,058.64	38		
WR-187	3.95 - 5.85	15													CMR-187	EAR99	PE9862-15	\$1,106.91	39	
		20														EAR99	PE9862-20	\$1,526.86	40	
		10														EAR99	PE-W229AN001	\$972.53	41	
WR-229	3.3 - 4.9	15														CMR-229	EAR99	PEWAN1001	\$1,284.21	42
		20															EAR99	PE9863-10	\$1,134.45	43
		10					EAR99										PE9863-20	\$1,855.03	44	
WR-284	2.6 - 3.95	10					CMR-284										EAR99	PE9864-10	\$1,461.09	45
		15															EAR99	PE9864-15	\$2,137.53	46
		20															EAR99	PE9864-20	\$3,603.58	47

Gain Horns With WG To Coax Adapters



Waveguide Type	RF Frequency (GHz.)	Gain (dB)	Flange Type - Connector	ECCN	Model No	1 Pc. Price	See Web for Volume Pricing	ROW
WR-28	26.5 - 40	10	WR-28 - 2.92mm Female	EAR99	PE9850/2F-10	\$1,591.91		48
		15		EAR99	PE9850/2F-15	\$1,649.62		49
		20		EAR99	PE9850/2F-20	\$1,692.80		50

Gain Horns With WG To Coax Adapters

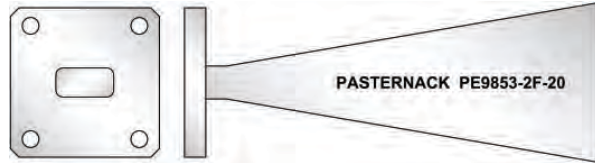

See Our Website For Current Pricing & Real-Time Stock Availability!

Waveguide Type	RF Frequency (GHz.)	Gain (dB)	Flange Type - Connector	ECCN	Model No	1 Pc. Price	See Web for Volume Pricing	ROW
WR-34	22 - 33	10	WR-34 - 2.92mm Female	EAR99	PE9851/2F-10	\$1,614.06	See Web for Volume Pricing	51
		15		EAR99	PE9851/2F-15	\$1,666.50		52
		20		EAR99	PE9851/2F-20	\$1,718.26		53
WR-42	18 - 26.5	10	WR-42 - 2.92mm Female	EAR99	PE9852/2F-10	\$1,353.13		54
		15		EAR99	PE9852/2F-15	\$1,411.36		55
		20		EAR99	PE9852/2F-20	\$1,441.39		56
WR-51	15 - 22	10	WR-51 - SMA Female	EAR99	PE9853/SF-10	\$1,249.36		57
		15		EAR99	PE9853/SF-15	\$1,470.92		58
		20		EAR99	PE9853/SF-20	\$1,500.85		59
WR-62	12.4 - 18	10	WR-62 - N Female	EAR99	PE9854/NF-10	\$1,072.22		60
		15		EAR99	PE9854/NF-15	\$1,159.41		61
		20		EAR99	PE9854/NF-20	\$1,192.23		62
		10	WR-62 - SMA Female	EAR99	PE9854/SF-10	\$1,104.82		63
		15		EAR99	PE9854/SF-15	\$1,148.57		64
WR-75	10 - 15	10	WR-75 - N Female	EAR99	PE9855/NF-10	\$1,197.26		65
		15		EAR99	PE9855/NF-15	\$1,197.26		66
		20		EAR99	PE9855/NF-20	\$1,249.36		67
		10	WR-75 - SMA Female	EAR99	PE9855/SF-10	\$1,093.06		68
		15		EAR99	PE9855/SF-15	\$1,142.78		69
WR-90	8.2 - 12.4	10	WR-90 - N Female	EAR99	PE9856/NF-10	\$1,186.84		70
		15		EAR99	PE9856/NF-15	\$1,102.63	71	
		20		EAR99	PE9856/NF-20	\$1,146.66	72	
		10	WR-90 - SMA Female	EAR99	PE9856/SF-10	\$1,228.52	73	
		15		EAR99	PE9856/SF-15	\$1,093.06	74	
WR-102	7 - 11	10	WR-102 - N Female	EAR99	PE9857/NF-10	\$1,145.16	75	
		15		EAR99	PE9857/NF-15	\$1,228.52	76	
		20		EAR99	PE9857/NF-20	\$1,220.24	77	
		10	WR-102 - SMA Female	EAR99	PE9857/SF-10	\$1,249.36	78	
		15		EAR99	PE9857/SF-15	\$1,301.46	79	
WR-112	7.05 - 10	10	WR-112 - N Female	EAR99	PE9858/NF-10	\$1,140.40	80	
		15		EAR99	PE9858/NF-15	\$1,140.40	81	
		20		EAR99	PE9858/NF-20	\$1,301.46	82	
		10	WR-112 - SMA Female	EAR99	PE9858/SF-10	\$1,236.55	83	
		15		EAR99	PE9858/SF-15	\$1,146.72	84	
WR-137	5.85 - 8.2	10	WR-137 - N Female	EAR99	PE9859/NF-10	\$1,176.42	85	
		15		EAR99	PE9859/NF-15	\$1,249.73	86	
		20		EAR99	PE9859/NF-20	\$1,093.06	87	
		10	WR-137 - SMA Female	EAR99	PE9859/SF-10	\$1,205.57	88	
		15		EAR99	PE9859/SF-15	\$1,249.73	89	
WR-159	4.9 - 7.05	10	WR-159 - N Female	EAR99	PE9860/NF-10	\$1,293.74	90	
		15		EAR99	PE9860/NF-15	\$1,281.79	91	
		20		EAR99	PE9860/NF-20	\$1,396.70	92	
		10	WR-159 - SMA Female	EAR99	PE9860/SF-10	\$1,293.74	93	
		15		EAR99	PE9860/SF-15	\$1,344.58	94	
WR-187	3.95 - 5.85	10	WR-187 - N Female	EAR99	PE9861/NF-10	\$1,396.70	95	
		15		EAR99	PE9861/NF-15	\$1,520.28	96	
		20		EAR99	PE9861/NF-20	\$1,582.80	97	
		10	WR-187 - SMA Female	EAR99	PE9861/SF-10	\$1,666.16	98	
		15		EAR99	PE9861/SF-15	\$1,503.25	99	
WR-229	3.3 - 4.9	10	WR-229 - N Female	EAR99	PE9862/NF-10	\$1,576.77	1	
		15		EAR99	PE9862/NF-15	\$1,614.06	2	
		20		EAR99	PE9862/NF-20	\$1,614.06	3	
		10	WR-229 - SMA Female	EAR99	PE9862/SF-10	\$1,301.46	4	
		15		EAR99	PE9862/SF-15	\$1,839.43	5	
WR-284	2.6 - 3.95	10	WR-284 - N Female	EAR99	PE9863/NF-10	\$1,881.67	6	
		15		EAR99	PE9863/NF-15	\$1,811.67	7	
		20		EAR99	PE9863/NF-20	\$1,645.32	8	
		10	WR-284 - SMA Female	EAR99	PE9863/SF-10	\$1,856.78	9	
		15		EAR99	PE9863/SF-15	\$1,853.72	10	
WR-284	2.6 - 3.95	10	WR-284 - SMA Female	EAR99	PE9863/SF-20	\$1,614.06	11	
		15		EAR99	PE9863/SF-15	\$1,690.63	12	
		20		EAR99	PE9863/SF-20	\$2,041.28	13	
WR-284	2.6 - 3.95	10	WR-284 - SMA Female	EAR99	PE9863/SF-10	\$2,039.08	14	
		15		EAR99	PE9863/SF-15	\$2,656.06	15	
		20		EAR99	PE9863/SF-20	\$2,291.36	16	

Waveguides



Free Shipping Available via UPS Ground to USA & Canada



Technical Support (866) 727-8376



Same-Day Shipping, Even Custom Cable Assemblies

Gain Horns With WG To Coax Adapters



Waveguide Type	RF Frequency (GHz.)	Gain (dB)	Flange Type - Connector	ECCN	Model No	1 Pc. Price	See Web for Volume Pricing	ROW
WR-430	1.7 - 2.6	10	WR-430 - N Female	EAR99	PE9864/NF-10	\$2,740.97	See Web for Volume Pricing	17
		15		EAR99	PE9864/NF-15	\$3,386.39		18
		20		EAR99	PE9864/NF-20	\$4,896.36		19
		10	WR-430 - SMA Female	EAR99	PE9864/SF-10	\$2,697.74		20
		15		EAR99	PE9864/SF-15	\$3,386.39		21
		20		EAR99	PE9864/SF-20	\$4,927.62		22

Specialty Waveguide Antennas

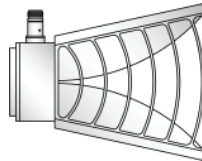

Waveguide Type	RF Frequency (GHz.)	Gain (dB)	Flange Type	ECCN	Model No	1 Pc. Price	See Web for Volume Pricing	ROW
Broadband	1 - 18			EAR99	PE9887-11	\$3,398.96	See Web for Volume Pricing	23
				EAR99	PE9888-11	\$3,431.32		24
WR-15	50 - 75	42	Round Cover - UG-385/U	5A991	PE9881-42	\$2,177.41	See Web for Volume Pricing	25
		20		EAR99	PE9881A-20	\$1,043.01		26
	56.5 - 67			5A991	PE9881-34	\$1,494.64		27
		0		EAR99	PE-W15A001	\$3,917.71		28

WAVEGUIDE BANDPASS FILTERS

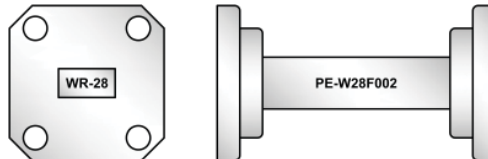

Waveguide Type	RF Frequency (GHz.)	Max VSWR	Flange Type	ECCN	Model No	1	2-4	5-9	10+	ROW
WR-28	38 - 40	1.5:1	Square Cover	EAR99	PE-W28F002	\$364.70	\$350.11	\$335.52	\$320.94	29
	30 - 31	1.4:1		EAR99	PE-W28F001	\$375.76	\$360.73	\$345.70	\$330.67	30
WR-42	25.05 - 25.25	1.5:1		EAR99	PE-W42F003	\$368.10	\$353.38	\$338.65	\$323.93	31
	24.25 - 24.45	1.8:1		EAR99	PE-W42F002	\$351.87	\$337.80	\$323.72	\$309.65	32
		1.5:1		EAR99	PE-W42F004	\$368.10	\$353.38	\$338.65	\$323.93	33
	20.2 - 21.2	1.5:1		EAR99	PE-W42F001	\$368.10	\$353.38	\$338.65	\$323.93	34

WAVEGUIDE BENDS

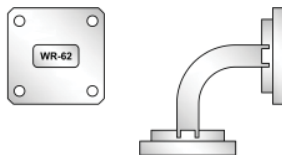

Waveguide Type	RF Frequency (GHz.)	Insertion Loss (dB)	Bend Plane	Flange Type	ECCN	Model No	1	2-4	5-9	10+	ROW
WR-10	75 - 110	0.21	E-Bend	Round Cover UG-387/U-Mod	EAR99	PE-W10B001	\$468.28	\$449.55	\$430.82	\$412.09	35
			H-Bend		EAR99	PE-W10B002	\$468.28	\$449.55	\$430.82	\$412.09	36
WR-12	60 - 90		E-Bend	Round Cover UG-387/U	EAR99	PE-W12B001	\$394.53	\$378.75	\$362.97	\$347.19	37

WAVEGUIDE BENDS

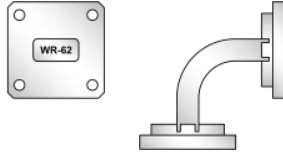

Waveguide Type	RF Frequency (GHz.)	Insertion Loss (dB)	Bend Plane	Flange Type	ECCN	Model No	1	2-4	5-9	10+	ROW
WR-12	60 - 90	0.21	H-Bend	Round Cover UG-387/U	EAR99	PE-W12B002	\$383.47	\$368.13	\$352.79	\$337.45	38
WR-15	50 - 75	0.17	E-Bend	Round Cover UG-385/U	EAR99	PE-W15B001	\$519.96	\$499.16	\$478.36	\$457.56	39
			H-Bend		EAR99	PE-W15B002	\$519.96	\$499.16	\$478.36	\$457.56	40
WR-19	40 - 60	0.18	E-Bend	Round Cover UG-383/U-Mod	EAR99	PE-W19B001	\$374.48	\$359.50	\$344.52	\$329.54	41
			H-Bend		EAR99	PE-W19B002	\$374.48	\$359.50	\$344.52	\$329.54	42
WR-22	33 - 50	0.16	E-Bend	Round Cover UG-383/U	EAR99	PE-W22B001	\$374.48	\$359.50	\$344.52	\$329.54	43
			H-Bend		EAR99	PE-W22B002	\$374.48	\$359.50	\$344.52	\$329.54	44
WR-28	26.5 - 40	0.28	E-Bend	Square Cover UG-599/U	EAR99	PE-W28B001	\$400.70	\$384.67	\$368.64	\$352.62	45
			H-Bend		EAR99	PE-W28B002	\$499.00	\$479.04	\$459.08	\$439.12	46
WR-42	18 - 26.5	0.1	E-Bend	Square Cover UG-595/U	EAR99	PE-W42B001A	\$400.70	\$384.67	\$368.64	\$352.62	47
			H-Bend		EAR99	PE-W42B002A	\$374.48	\$359.50	\$344.52	\$329.54	48
WR-51	15 - 22	0.09	E-Bend	UBR180	EAR99	PE-W51B001	\$364.70	\$350.11	\$335.52	\$320.94	49
			H-Bend		EAR99	PE-W51B002	\$364.70	\$350.11	\$335.52	\$320.94	50
WR-62	12.4 - 18	0.15	E-Bend	Square Cover UG-419/U	EAR99	PE-W62B001	\$405.54	\$389.32	\$373.10	\$356.88	51
			H-Bend		EAR99	PE-W62B002	\$405.54	\$389.32	\$373.10	\$356.88	52
		0.09	E-Bend		EAR99	PE-W62B003	\$364.70	\$350.11	\$335.52	\$320.94	53
			H-Bend		EAR99	PE-W62B004	\$390.23	\$374.62	\$359.01	\$343.40	54
WR-75	10 - 15	0.15	E-Bend	UBR120	EAR99	PE-W75B001	\$411.73	\$395.26	\$378.79	\$362.32	55
			H-Bend		EAR99	PE-W75B002	\$444.23	\$426.46	\$408.69	\$390.92	56
WR-90	8.2 - 12.4	0.15	E-Bend	Square Cover UG-39/U	EAR99	PE-W90B001	\$377.39	\$362.29	\$347.20	\$332.10	57
			H-Bend		EAR99	PE-W90B002	\$385.84	\$370.41	\$354.97	\$339.54	58
			CPR-90G	E-Bend	EAR99	PE-W90B003	\$333.44	\$320.10	\$306.76	\$293.43	59
				H-Bend	EAR99	PE-W90B004	\$333.44	\$320.10	\$306.76	\$293.43	60
WR-112	7.05 - 10	0.15	E-Bend	Square Cover UG-51/U	EAR99	PE-W112B001	\$547.93	\$526.01	\$504.10	\$482.18	61
			H-Bend		EAR99	PE-W112B002	\$471.66	\$452.79	\$433.93	\$415.06	62
WR-137	5.85 - 8.2	0.15	E-Bend	Round Cover UG-344/U	EAR99	PE-W137B001	\$416.80	\$400.13	\$383.46	\$366.78	63
			H-Bend		EAR99	PE-W137B002	\$416.80	\$400.13	\$383.46	\$366.78	64
			CPR-137G	E-Bend	EAR99	PE-W137B003	\$488.11	\$468.59	\$449.06	\$429.54	65
				H-Bend	EAR99	PE-W137B004	\$488.11	\$468.59	\$449.06	\$429.54	66

WAVEGUIDE BULKHEAD ADAPTERS

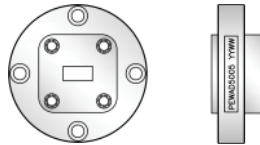

Frequency Range (GHz.)	Waveguide Size	Flange 1	Flange 2	Model No	1	2-4	5-9	10+	ROW
75.0 - 110.0	WR-10	Round Cover UG-387/U-Mod	Round Cover UG-387/U-Mod	PEWAD5000	\$930.85	\$893.62	\$856.38	\$819.15	67
60.0 - 90.0	WR-12	Round Cover UG-387/U	Round Cover UG-387/U	PEWAD5001	\$930.85	\$893.62	\$856.38	\$819.15	68
50.0 - 75.0	WR-15	Round Cover UG-385/U	Round Cover UG-385/U	PEWAD5002	\$930.85	\$893.62	\$856.38	\$819.15	69
40.0 - 60.0	WR-19	Round Cover UG-383/U-Mod	Round Cover UG-383/U-Mod	PEWAD5003	\$930.85	\$893.62	\$856.38	\$819.15	70
33.0 - 50.0	WR-22	Round Cover UG-383/U	Round Cover UG-383/U	PEWAD5007	\$850.98	\$816.94	\$782.90	\$748.86	71
			Round Cover UG-383/U	PEWAD5004	\$930.85	\$893.62	\$856.38	\$819.15	72
26.5 - 40.0	WR-28	Square Cover UG-599/U	Square Cover UG-599/U	PEWAD5008	\$743.29	\$713.56	\$683.83	\$654.10	73
			Square Cover UG-599/U	PEWAD5005	\$1,042.56	\$1,000.86	\$959.16	\$917.45	74
22.0 - 33.0	WR-34	Square Cover UG-1530/U	Square Cover UG-1530/U	PEWAD5009	\$757.20	\$726.91	\$696.62	\$666.34	75
18.0 - 26.5	WR-42	Square Cover UG-595/U	Square Cover UG-595/U	PEWAD5010	\$778.04	\$746.92	\$715.80	\$684.68	76
			Square Cover UG-595/U	PEWAD5006	\$1,042.56	\$1,000.86	\$959.16	\$917.45	77
15.0 - 22.0	WR-51	Square Cover	Square Cover	PEWAD5011	\$791.92	\$760.24	\$728.57	\$696.89	78
12.4 - 18.0	WR-62	Square Cover UG-1665/U	Square Cover UG-1665/U	PEWAD5012	\$826.65	\$793.58	\$760.52	\$727.45	79
10.0 - 15.0	WR-75	Square Cover	Square Cover	PEWAD5013	\$850.98	\$816.94	\$782.90	\$748.86	80
8.2 - 12.4	WR-90	Square Cover UG-39/U CPR-90G	Square Cover UG-39/U	PEWAD5014	\$882.24	\$846.95	\$811.66	\$776.37	81
			CPR-90G	PEWAD5015	\$882.24	\$846.95	\$811.66	\$776.37	82
7.05 - 10.0	WR-112	Square Cover UG-51/U CPR-112G	Square Cover UG-51/U	PEWAD5016	\$930.85	\$893.62	\$856.38	\$819.15	83
			CPR-112G	PEWAD5017	\$930.85	\$893.62	\$856.38	\$819.15	84



Free Shipping Available via UPS Ground to USA & Canada



Technical Support (866) 727-8376



Same-Day Shipping, Even Custom Cable Assemblies

WAVEGUIDE BULKHEAD ADAPTERS

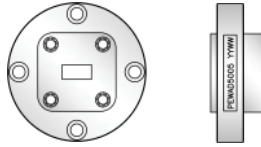

Frequency Range (GHz.)	Waveguide Size	Flange 1	Flange 2	Model No	1	2-4	5-9	10+	ROW
5.85 - 8.2	WR-137	Square Cover UG-344/U	Square Cover UG-344/U	PEWAD5018	\$979.48	\$940.30	\$901.12	\$861.94	85
		CPR-137G	CPR-137G	PEWAD5019	\$979.48	\$940.30	\$901.12	\$861.94	86

WAVEGUIDE CONVERTER MIXERS

Down Converter

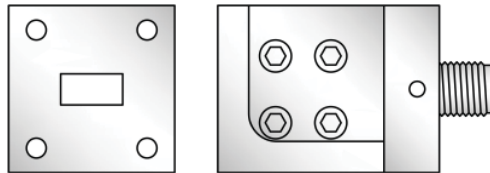

RF/LO Frequency (GHz.)	IF Frequency (GHz.)	LO Power (dBm)	Typ Conv. Loss (dB)	RF & LO Waveguide Type	IF Connector	ECCN	Model No	1	2-4	5-9	10+	ROW
26.5 - 40	DC - 18	15	6	WR-28 UG-599/U	SMA Female	EAR99	PE12D1005	\$3,371.18	\$3,168.91	\$3,000.35	\$2,865.50	87
33 - 50	DC - 18	15	7	WR-22 UG-383/U	SMA Female	EAR99	PE12D1004	\$3,800.23	\$3,572.22	\$3,382.20	\$3,230.20	88
40 - 60	DC - 18	15	7	WR-19 UG-383/U	SMA Female	EAR99	PE12D1003	\$3,938.15	\$3,701.86	\$3,504.95	\$3,347.43	89
50 - 75	DC - 18	15	8	WR-15 UG-385/U	SMA Female	EAR99	PE12D1002	\$4,106.70	\$3,860.30	\$3,654.96	\$3,490.70	90
60 - 90	DC - 18	15	9	WR-12 UG-387/U	SMA Female	EAR99	PE12D1001	\$4,229.30	\$3,975.54	\$3,764.08	\$3,594.91	91
75 - 110	DC - 18	15	9	WR-10 UG-387/U-Mod	SMA Female	EAR99	PE12D1000	\$4,535.77	\$4,263.62	\$4,036.84	\$3,855.40	92

Up Converter

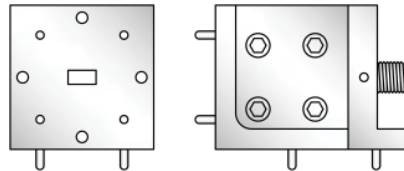

RF/LO Frequency (GHz.)	IF Frequency (GHz.)	LO Power (dBm)	Typ Conv. Loss (dB)	RF & LO Waveguide Type	IF Connector	ECCN	Model No	1	2-4	5-9	10+	ROW
26.5 - 40	DC - 18	15	6	WR-28 UG-599/U	SMA Female	EAR99	PE13U1005	\$3,784.91	\$3,557.82	\$3,368.57	\$3,217.17	93
33 - 50	DC - 18	15	7	WR-22 UG-383/U	SMA Female	EAR99	PE13U1004	\$4,321.23	\$4,061.96	\$3,845.89	\$3,673.05	94
40 - 60	DC - 18	15	7	WR-19 UG-383/U	SMA Female	EAR99	PE13U1003	\$4,443.82	\$4,177.19	\$3,955.00	\$3,777.25	95
50 - 75	DC - 18	15	8	WR-15 UG-385/U	SMA Female	EAR99	PE13U1002	\$4,597.06	\$4,321.24	\$4,091.38	\$3,907.50	96
60 - 90	DC - 18	15	9	WR-12 UG-387/U	SMA Female	EAR99	PE13U1001	\$4,765.62	\$4,479.68	\$4,241.40	\$4,050.78	97
75 - 110	DC - 18	15	9	WR-10 UG-387/U	SMA Female	EAR99	PE13U1000	\$5,087.41	\$4,782.17	\$4,527.79	\$4,324.30	98

PasterFact™:

In 1864, the existence of radio waves was predicted by James Clerk Maxwell, a Scottish physicist.

WAVEGUIDE COUPLERS

Broadwall



See Our Website For Current Pricing & Real-Time Stock Availability!

WG Type	RF Freq. (GHz.)	IL (dB)	Max VSWR	Coupling (dB)	Directivity (dB)	Flange Type	ECCN	Model No	1	2-4	5-9	10+	ROW		
WR-10	75 - 110	1.4	1.2:1	10	30	Round Cover UG-387/U-Mod	EAR99	PE-W10CP001-10	\$2,344.50	\$2,250.72	\$2,156.94	\$2,063.16	1		
				10	30		EAR99	PE-W10CP003-10	\$2,467.90	\$2,369.18	\$2,270.47	\$2,171.75	2		
		1.1		20	30		EAR99	PE-W10CP001-20	\$2,344.50	\$2,250.72	\$2,156.94	\$2,063.16	3		
				20	30		EAR99	PE-W10CP003-20	\$2,467.90	\$2,369.18	\$2,270.47	\$2,171.75	4		
WR-12	60 - 90	1.4		1.2:1	10	30	Round Cover UG-387/U	EAR99	PE-W12CP001-10	\$2,366.04	\$2,271.40	\$2,176.76	\$2,082.12	5	
					10	30		EAR99	PE-W12CP003-10	\$2,490.57	\$2,390.95	\$2,291.32	\$2,191.70	6	
		1			20	30		EAR99	PE-W12CP001-20	\$2,366.04	\$2,271.40	\$2,176.76	\$2,082.12	7	
					20	30		EAR99	PE-W12CP003-20	\$2,394.78	\$2,298.99	\$2,203.20	\$2,107.41	8	
WR-15	50 - 75	1.4	1.2:1		10	30	Round Cover UG-385/U	EAR99	PE-W15CP001-10	\$2,230.25	\$2,141.04	\$2,051.83	\$1,962.62	9	
					10	30		EAR99	PE-W15CP003-10	\$2,230.25	\$2,141.04	\$2,051.83	\$1,962.62	10	
		1			20	30		EAR99	PE-W15CP001-20	\$2,339.93	\$2,246.33	\$2,152.74	\$2,059.14	11	
					20	30		EAR99	PE-W15CP003-20	\$2,339.93	\$2,246.33	\$2,152.74	\$2,059.14	12	
WR-19	40 - 60	1.4		1.2:1	10	30	Round Cover UG-383/U	EAR99	PE-W19CP001-10	\$2,170.83	\$2,084.00	\$1,997.16	\$1,910.33	13	
					10	30		EAR99	PE-W19CP003-10	\$2,330.79	\$2,237.56	\$2,144.33	\$2,051.10	14	
		0.8			20	30		EAR99	PE-W19CP001-20	\$2,170.83	\$2,084.00	\$1,997.16	\$1,910.33	15	
					20	30		EAR99	PE-W19CP003-20	\$2,285.09	\$2,193.69	\$2,102.28	\$2,010.88	16	
WR-22	33 - 50	1.2	1.2:1		10	30	Round Cover UG-383/U	EAR99	PE-W22CP001-10	\$2,230.25	\$2,141.04	\$2,051.83	\$1,962.62	17	
					10	30		EAR99	PE-W22CP003-10	\$2,230.25	\$2,141.04	\$2,051.83	\$1,962.62	18	
		0.8			20	30		EAR99	PE-W22CP001-20	\$2,230.25	\$2,141.04	\$2,051.83	\$1,962.62	19	
					20	30		EAR99	PE-W22CP003-20	\$2,319.47	\$2,226.69	\$2,133.91	\$2,041.13	20	
WR-28	26.5 - 40	1		1.2:1	10	30	Square Cover UG-599/U	EAR99	PE-W28CP002-10	\$2,157.13	\$2,070.84	\$1,984.56	\$1,898.27	21	
					10	30		EAR99	PE-W28CP003-10	\$2,243.42	\$2,153.68	\$2,063.95	\$1,974.21	22	
		0.6			20	30		EAR99	PE-W28CP002-20	\$2,157.13	\$2,070.84	\$1,984.56	\$1,898.27	23	
					20	30		EAR99	PE-W28CP003-20	\$2,200.28	\$2,112.27	\$2,024.26	\$1,936.25	24	
WR-34	22 - 33	0.35	1.05:1		10	35	Square Cover UG-1530/U	EAR99	PEWCP1005	\$1,451.87	\$1,393.80	\$1,335.72	\$1,277.65	25	
					10	35		EAR99	PEWCP1006	\$1,451.87	\$1,393.80	\$1,335.72	\$1,277.65	26	
		0.15			20	35		EAR99	PEWCP1007	\$1,451.87	\$1,393.80	\$1,335.72	\$1,277.65	27	
					30	35		EAR99	PE-W42CP002-10	\$2,157.13	\$2,070.84	\$1,984.56	\$1,898.27	28	
WR-42	18 - 26.5	1		1.2:1	10	30	Square Cover UG-595/U	EAR99	PE-W42CP003-10	\$2,243.42	\$2,153.68	\$2,063.95	\$1,974.21	29	
					10	30		EAR99	PE-W42CP002-20	\$2,157.13	\$2,070.84	\$1,984.56	\$1,898.27	30	
		0.6			20	30		EAR99	PE-W42CP003-20	\$2,243.42	\$2,153.68	\$2,063.95	\$1,974.21	31	
					20	30		EAR99	PEWCP1008	\$1,424.08	\$1,367.12	\$1,310.15	\$1,253.19	32	
WR-51	15 - 22	0.15	1.05:1		10	35	Square Cover UG-419/U	EAR99	PEWCP1009	\$1,424.08	\$1,367.12	\$1,310.15	\$1,253.19	33	
					10	35		EAR99	PEWCP1010	\$1,481.04	\$1,421.80	\$1,362.56	\$1,303.32	34	
					20	40		EAR99	PEWCP1011	\$1,271.24	\$1,220.39	\$1,169.54	\$1,118.69	35	
					20	40		EAR99	PEWCP1012	\$1,322.09	\$1,269.21	\$1,216.32	\$1,163.44	36	
WR-62	12.4 - 18			0.15	1.05:1	10	40	Square Cover UG-419/U	EAR99	PEWCP1013	\$1,322.09	\$1,269.21	\$1,216.32	\$1,163.44	37
						10	40		EAR99	PEWCP1014	\$1,292.08	\$1,240.40	\$1,188.71	\$1,137.03	38
						20	40		EAR99	PEWCP1015	\$1,292.08	\$1,240.40	\$1,188.71	\$1,137.03	39
						30	40		EAR99	PEWCP1016	\$1,343.77	\$1,290.02	\$1,236.27	\$1,182.52	40
WR-75	10 - 15	0.15	1.05:1			10	40	Square Cover UG-39/U	EAR99	PEWCP1017	\$1,488.27	\$1,428.74	\$1,369.21	\$1,309.68	41
						10	40		EAR99	PEWCP1020	\$1,437.96	\$1,380.44	\$1,322.92	\$1,265.40	42
						20	40		EAR99	PEWCP1018	\$1,431.03	\$1,373.79	\$1,316.55	\$1,259.31	43
						20	40		EAR99	PEWCP1021	\$1,437.96	\$1,380.44	\$1,322.92	\$1,265.40	44
WR-90	8.2 - 12.4			0.15	1.05:1	30	40	Square Cover UG-39/U	EAR99	PEWCP1019	\$1,488.27	\$1,428.74	\$1,369.21	\$1,309.68	45
						30	40		EAR99	PEWCP1022	\$1,437.96	\$1,380.44	\$1,322.92	\$1,265.40	46
						10	40		EAR99	PEWCP1023	\$1,319.88	\$1,267.08	\$1,214.29	\$1,161.49	47
						10	40		EAR99	PEWCP1026	\$1,368.51	\$1,313.77	\$1,259.03	\$1,204.29	48
WR-112	7.05 - 10	0.15	1.05:1			20	40	Square Cover UG-51/U	EAR99	PEWCP1024	\$1,319.88	\$1,267.08	\$1,214.29	\$1,161.49	49
						20	40		EAR99	PEWCP1027	\$1,368.51	\$1,313.77	\$1,259.03	\$1,204.29	50
						30	40		EAR99	PEWCP1025	\$1,319.88	\$1,267.08	\$1,214.29	\$1,161.49	51
						30	40		EAR99	PEWCP1028	\$1,368.51	\$1,313.77	\$1,259.03	\$1,204.29	52
WR-137	5.85 - 8.2			0.15	1.05:1	10	40	Round Cover UG-344/U	EAR99	PEWCP1029	\$1,396.28	\$1,340.43	\$1,284.58	\$1,228.73	53
						10	40		EAR99	PEWCP1032	\$1,444.92	\$1,387.12	\$1,329.33	\$1,271.53	54
						20	40		EAR99	PEWCP1030	\$1,396.28	\$1,340.43	\$1,284.58	\$1,228.73	55
						20	40		EAR99	PEWCP1033	\$1,444.92	\$1,387.12	\$1,329.33	\$1,271.53	56

Waveguides



Free Shipping Available via UPS Ground to USA & Canada



Technical Support (866) 727-8376



Same-Day Shipping, Even Custom Cable Assemblies

Broadwall

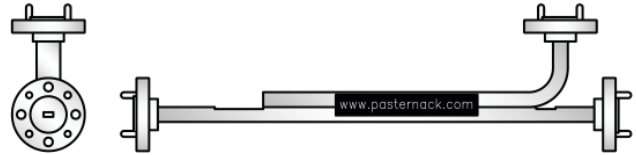

WG Type	RF Freq. (GHz.)	IL (dB)	Max VSWR	Coupling (dB)	Directivity (dB)	Flange Type	ECCN	Model No	1	2-4	5-9	10+	ROW
WR-137	5.85 - 8.2	0.15	1.05:1	30	40	Round Cover UG-344/U	EAR99	PEWCP1031	\$1,396.28	\$1,340.43	\$1,284.58	\$1,228.73	57
				30	40	CPR-137G	EAR99	PEWCP1034	\$1,444.92	\$1,387.12	\$1,329.33	\$1,271.53	58

Crossguide*



WG Type	RF Freq. (GHz.)	IL (dB)	Max VSWR	Coupling (dB)	Directivity (dB)	Flange Type	ECCN	Model No	1	2-4	5-9	10+	ROW
WR-34	22 - 33	0.1	1.05:1	20	20	Square Cover UG-1530/U	EAR99	PEWCP1035	\$977.51	\$938.41	\$899.31	\$860.21	59
				30	20		EAR99	PEWCP1036	\$977.51	\$938.41	\$899.31	\$860.21	60
				40	25		EAR99	PEWCP1037	\$977.51	\$938.41	\$899.31	\$860.21	61
				50	10		EAR99	PEWCP1038	\$977.51	\$938.41	\$899.31	\$860.21	62
WR-42	18 - 26.5	0.1	1.05:1	20	30	Square Cover UG-595/U	EAR99	PEWCP1039	\$779.03	\$747.87	\$716.71	\$685.55	63
				30	20		EAR99	PEWCP1040	\$810.19	\$777.78	\$745.37	\$712.97	64
				40	20		EAR99	PEWCP1041	\$779.03	\$747.87	\$716.71	\$685.55	65
				50	10		EAR99	PEWCP1042	\$810.19	\$777.78	\$745.37	\$712.97	66
WR-51	15 - 22	0.1	1.05:1	20	20	Square Cover UG-419/U	EAR99	PEWCP1043	\$1,203.26	\$1,155.13	\$1,107.00	\$1,058.87	67
				30	30		EAR99	PEWCP1044	\$1,203.26	\$1,155.13	\$1,107.00	\$1,058.87	68
				40	30		EAR99	PEWCP1045	\$1,203.26	\$1,155.13	\$1,107.00	\$1,058.87	69
				50	10		EAR99	PEWCP1046	\$1,203.26	\$1,155.13	\$1,107.00	\$1,058.87	70
WR-62	12.4 - 18	0.1	1.05:1	20	20	Square Cover UG-419/U	EAR99	PEWCP1047	\$779.03	\$747.87	\$716.71	\$685.55	71
				30	10		EAR99	PEWCP1048	\$779.03	\$747.87	\$716.71	\$685.55	72
				40	30		EAR99	PEWCP1049	\$779.03	\$747.87	\$716.71	\$685.55	73
				50	10		EAR99	PEWCP1050	\$779.03	\$747.87	\$716.71	\$685.55	74
WR-75	10 - 15	0.1	1.05:1	20	25	Square Cover UG-419/U	EAR99	PEWCP1051	\$783.98	\$752.62	\$721.26	\$689.90	75
				30	25		EAR99	PEWCP1052	\$783.98	\$752.62	\$721.26	\$689.90	76
				40	15		EAR99	PEWCP1053	\$783.98	\$752.62	\$721.26	\$689.90	77
				50	10		EAR99	PEWCP1054	\$783.98	\$752.62	\$721.26	\$689.90	78
WR-90	8.2 - 12.4	0.1	1.05:1	20	20	Square Cover UG-39/U	EAR99	PEWCP1055	\$764.13	\$733.56	\$703.00	\$672.43	79
				20	25	CPR-90G	EAR99	PEWCP1059	\$818.71	\$785.96	\$753.21	\$720.46	80
				30	20	Square Cover UG-39/U	EAR99	PEWCP1056	\$764.13	\$733.56	\$703.00	\$672.43	81
				30	20	CPR-90G	EAR99	PEWCP1060	\$818.71	\$785.96	\$753.21	\$720.46	82
				40	10	Square Cover UG-39/U	EAR99	PEWCP1057	\$794.71	\$762.92	\$731.13	\$699.34	83
				40	10	CPR-90G	EAR99	PEWCP1061	\$818.71	\$785.96	\$753.21	\$720.46	84
				50	10	Square Cover UG-39/U	EAR99	PEWCP1058	\$794.71	\$762.92	\$731.13	\$699.34	85
				50	10	CPR-90G	EAR99	PEWCP1062	\$851.46	\$817.40	\$783.34	\$749.28	86
WR-112	7.05 - 10	0.1	1.05:1	20	45	Square Cover UG-51/U	EAR99	PEWCP1063	\$878.97	\$843.81	\$808.65	\$773.49	87
				20	25	CPR-112G	EAR99	PEWCP1067	\$888.18	\$852.65	\$817.13	\$781.60	88
				30	25	Square Cover UG-51/U	EAR99	PEWCP1064	\$878.97	\$843.81	\$808.65	\$773.49	89
				30	25	CPR-112G	EAR99	PEWCP1068	\$888.18	\$852.65	\$817.13	\$781.60	90
				40	20	Square Cover UG-51/U	EAR99	PEWCP1065	\$878.97	\$843.81	\$808.65	\$773.49	91
				40	20	CPR-112G	EAR99	PEWCP1069	\$888.18	\$852.65	\$817.13	\$781.60	92
				50	10	Square Cover UG-51/U	EAR99	PEWCP1066	\$914.14	\$877.57	\$841.01	\$804.44	93
				50	10	CPR-112G	EAR99	PEWCP1070	\$923.72	\$886.77	\$849.82	\$812.87	94
WR-137	5.85 - 8.2	0.1	1.05:1	20	25	Round Cover UG-344/U	EAR99	PEWCP1071	\$893.14	\$857.41	\$821.69	\$785.96	95
				20	20	CPR-137G	EAR99	PEWCP1075	\$853.46	\$819.32	\$785.18	\$751.04	96
				30	20	Round Cover UG-344/U	EAR99	PEWCP1072	\$893.14	\$857.41	\$821.69	\$785.96	97

*These WG crossguide couplers are available as assemblies with termination and/or with WG to Coax Adapters, see WG Coupler Assemblies or visit our website

See Our Website For Current Pricing & Real-Time Stock Availability!

Waveguides

Crossguide*



WG Type	RF Freq. (GHz.)	IL (dB)	Max VSWR	Coupling (dB)	Directivity (dB)	Flange Type	ECCN	Model No	1	2-4	5-9	10+	ROW
WR-137	5.85 - 8.2	0.1	1.05:1	30	20	CPR-137G	EAR99	PEWCP1076	\$853.46	\$819.32	\$785.18	\$751.04	98
				40	20	Round Cover UG-344/U	EAR99	PEWCP1073	\$893.14	\$857.41	\$821.69	\$785.96	99
				40	20	CPR-137G	EAR99	PEWCP1077	\$853.46	\$819.32	\$785.18	\$751.04	1
				50	10	Round Cover UG-344/U	EAR99	PEWCP1074	\$893.14	\$857.41	\$821.69	\$785.96	2
				50	10	CPR-137G	EAR99	PEWCP1078	\$853.46	\$819.32	\$785.18	\$751.04	3

*These WG crossguide couplers are available as assemblies with termination and/or with WG to Coax Adapters, see WG Coupler Assemblies or visit our website

WAVEGUIDE COUPLER ASSEMBLIES

WG Crossguide Coupler	WG Crossguide Coupler with Termination	WG Crossguide Coupler with Termination & Coax Adapter SMA/ Type N	Conn. Type
PEWCP1035	PEWCT1000	PEWCT1044	2.92mm
PEWCP1036	PEWCT1001	PEWCT1045	2.92mm
PEWCP1037	PEWCT1002	PEWCT1046	2.92mm
PEWCP1038	PEWCT1003	PEWCT1047	2.92mm
PEWCP1039	PEWCT1004	PEWCT1048	SMA
PEWCP1040	PEWCT1005	PEWCT1049	SMA
PEWCP1041	PEWCT1006	PEWCT1050	SMA
PEWCP1042	PEWCT1007	PEWCT1051	SMA
PEWCP1043	PEWCT1008	PEWCT1052	SMA
PEWCP1044	PEWCT1009	PEWCT1053	SMA
PEWCP1045	PEWCT1010	PEWCT1054	SMA
PEWCP1046	PEWCT1011	PEWCT1055	SMA
PEWCP1047	PEWCT1012	PEWCT1056	SMA
PEWCP1048	PEWCT1013	PEWCT1057	SMA
PEWCP1049	PEWCT1014	PEWCT1058	SMA
PEWCP1050	PEWCT1015	PEWCT1059	SMA
PEWCP1051	PEWCT1016	PEWCT1060	SMA
		PEWCT1064	N
PEWCP1052	PEWCT1017	PEWCT1061	SMA
		PEWCT1065	N
PEWCP1053	PEWCT1018	PEWCT1062	SMA
		PEWCT1066	N
PEWCP1054	PEWCT1019	PEWCT1063	SMA
		PEWCT1067	N
PEWCP1055	PEWCT1020	PEWCT1068	SMA
		PEWCT1076	N
PEWCP1056	PEWCT1021	PEWCT1069	SMA
		PEWCT1077	N
PEWCP1057	PEWCT1022	PEWCT1070	SMA
		PEWCT1078	N
PEWCP1058	PEWCT1023	PEWCT1071	SMA
		PEWCT1079	N
PEWCP1059	PEWCT1024	PEWCT1072	SMA
		PEWCT1080	N
PEWCP1060	PEWCT1025	PEWCT1073	SMA
		PEWCT1081	N

WG Crossguide Coupler	WG Crossguide Coupler with Termination	WG Crossguide Coupler with Termination & Coax Adapter SMA/ Type N	Conn. Type
PEWCP1061	PEWCT1026	PEWCT1074	SMA
		PEWCT1082	N
PEWCP1062	PEWCT1027	PEWCT1075	SMA
		PEWCT1083	N
PEWCP1063	PEWCT1028	PEWCT1084	SMA
		PEWCT1092	N
PEWCP1064	PEWCT1029	PEWCT1085	SMA
		PEWCT1093	N
PEWCP1065	PEWCT1030	PEWCT1086	SMA
		PEWCT1094	N
PEWCP1066	PEWCT1031	PEWCT1087	SMA
		PEWCT1095	N
PEWCP1067	PEWCT1032	PEWCT1088	SMA
		PEWCT1096	N
PEWCP1068	PEWCT1033	PEWCT1089	SMA
		PEWCT1097	N
PEWCP1069	PEWCT1034	PEWCT1090	SMA
		PEWCT1098	N
PEWCP1070	PEWCT1035	PEWCT1091	SMA
		PEWCT1099	N
PEWCP1071	PEWCT1036	PEWCT1100	SMA
		PEWCT1108	N
PEWCP1072	PEWCT1037	PEWCT1101	SMA
		PEWCT1109	N
PEWCP1073	PEWCT1038	PEWCT1102	SMA
		PEWCT1110	N
PEWCP1074	PEWCT1039	PEWCT1103	SMA
		PEWCT1111	N
PEWCP1075	PEWCT1040	PEWCT1104	SMA
		PEWCT1112	N
PEWCP1076	PEWCT1041	PEWCT1105	SMA
		PEWCT1113	N
PEWCP1077	PEWCT1042	PEWCT1106	SMA
		PEWCT1114	N
PEWCP1078	PEWCT1043	PEWCT1107	SMA
		PEWCT1115	N

See Our Website For Current Pricing & Real-Time Stock Availability!

Waveguides



Free Shipping Available via UPS Ground to USA & Canada



Technical Support (866) 727-8376



Same-Day Shipping, Even Custom Cable Assemblies

WAVEGUIDE DETECTORS

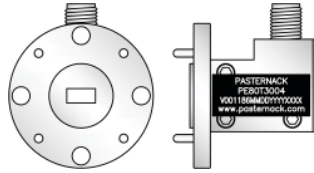

Connector 1	RF Frequency (GHz)	Voltage Sensitivity (V/nW)	Input Power (dBm)	Connector 2	ECCN	Model No	1	2-4	5-9	10+	ROW
WR-10 UG-387/U	75 - 100	-900	20	SMA Female	EAR99	PE80T3000	\$3,340.54	\$3,140.11	\$2,973.08	\$2,839.46	1
WR-12 UG-387/U	60 - 90	-900		SMA Female	EAR99	PE80T3001	\$3,699.10	\$3,477.15	\$3,292.20	\$3,144.24	2
WR-15 UG-385/U	50 - 75	-700		SMA Female	EAR99	PE80T3002	\$3,663.68	\$3,443.86	\$3,260.68	\$3,114.13	3
WR-19 UG-383/U	40 - 60	-800		SMA Female	EAR99	PE80T3003	\$3,629.29	\$3,411.53	\$3,230.07	\$3,084.90	4
WR-22 UG-383/U	33 - 50	-800		SMA Female	EAR99	PE80T3004	\$3,560.52	\$3,346.89	\$3,168.86	\$3,026.44	5
WR-28 UG-599/U	26.5 - 40	-1,000		SMA Female	EAR99	PE80T3005	\$3,230.20	\$3,036.39	\$2,874.88	\$2,745.67	6

WAVEGUIDE DIRECT READ ATTEN.



WG Type	RF Freq. (GHz.)	Max Atten (dB)	IL (dB)	Max VSWR	Input Power (Watts)	Flange Type	ECCN	Model No	1	2-4	5-9	10+	ROW
WR-10	75 - 110	50	1	1.2:1	0.2	Round Cover UG-387/U-Mod	EAR99	PE-W10AT5001	\$5,198.54	\$4,990.60	\$4,782.66	\$4,574.72	7
WR-12	60 - 90		0.9	1.2:1	0.2	Round Cover UG-387/U	EAR99	PE-W12AT5001	\$5,406.48	\$5,190.22	\$4,973.96	\$4,757.70	8
WR-15	50 - 75		0.8	1.2:1	0.3	Round Cover UG-385/U	EAR99	PE-W15AT5001	\$5,198.54	\$4,990.60	\$4,782.66	\$4,574.72	9
WR-19	40 - 60		0.7	1.15:1	0.2	Round Cover UG-383/U-Mod	EAR99	PE-W19AT5001	\$5,198.54	\$4,990.60	\$4,782.66	\$4,574.72	10
WR-22	33 - 50		0.6	1.15:1	0.4	Round Cover UG-383/U	EAR99	PE-W22AT5001	\$5,198.54	\$4,990.60	\$4,782.66	\$4,574.72	11
WR-28	26.5 - 40		0.5	1.15:1	0.5	Square Cover UG-599/U	EAR99	PE-W28AT5001	\$5,198.54	\$4,990.60	\$4,782.66	\$4,574.72	12
WR-42	18 - 26.5		1	1.15:1	1	Square Cover UG-595/U	EAR99	PE-W42AT5001	\$5,406.48	\$5,190.22	\$4,973.96	\$4,757.70	13

WAVEGUIDE EMS



- Features:
- A: Absorptive
 - AR: Auto Reset
 - B: Break Before Make
 - F: Failsafe
 - D: Diode
 - GR: Global Reset
 - H: Hot Switches
 - I: Indicators
 - L: Latching
 - M: Manual Override
 - N: Normally Open
 - P: Pulse
 - R: Reflective
 - RS: Reset
 - S: Self Cut Off
 - T: Terminated
 - TTL: TTL Logic

WG Type	Switch Type	RF Freq. (GHz.)	Actuator / Features	IL (dB)	Iso (dB)	DC Power (V)	ECCN	Model No	1	2-4	5-9	10+	ROW
WR-28	SPDT	26.5 - 40	B/L/S, I, M	0.15	55	28	EAR99	PEWGS6000	\$3,490.70	\$3,281.26	\$3,106.72	\$2,967.10	14
			B/L/TTL, S, I, M	0.15	55		EAR99	PEWGS6001	\$3,490.70	\$3,281.26	\$3,106.72	\$2,967.10	15
			B/L/S, I, M	0.15	55	12	EAR99	PEWGS6002	\$3,386.50	\$3,183.31	\$3,013.99	\$2,878.53	16
WR-42		18 - 26.5	B/L/TTL, S, I, M	0.15	55	28	EAR99	PEWGS6003	\$3,386.50	\$3,183.31	\$3,013.99	\$2,878.53	17
			B/L/S, I, M	0.15	60		EAR99	PEWGS6004	\$3,490.70	\$3,281.26	\$3,106.72	\$2,967.10	18
			B/L/TTL, S, I, M	0.15	60	12	EAR99	PEWGS6005	\$3,490.70	\$3,281.26	\$3,106.72	\$2,967.10	19
WR-62	12.4 - 18	B/L/S, I, M	0.15	60	28	EAR99	PEWGS6006	\$3,386.50	\$3,183.31	\$3,013.99	\$2,878.53	20	
		B/L/TTL, S, I, M	0.15	60		EAR99	PEWGS6007	\$3,386.50	\$3,183.31	\$3,013.99	\$2,878.53	21	
		B/L/S, I, M	0.1	60	12	EAR99	PEWGS6008	\$3,490.70	\$3,281.26	\$3,106.72	\$2,967.10	22	
WR-75	10 - 15	B/L/TTL, S, I, M	0.1	60	28	EAR99	PEWGS6009	\$3,490.70	\$3,281.26	\$3,106.72	\$2,967.10	23	
		B/L/S, I, M	0.1	60		EAR99	PEWGS6010	\$3,386.50	\$3,183.31	\$3,013.99	\$2,878.53	24	
		B/L/TTL, S, I, M	0.1	60	12	EAR99	PEWGS6011	\$3,386.50	\$3,183.31	\$3,013.99	\$2,878.53	25	
WR-75	10 - 15	B/L/S, I, M	0.05	75	28	EAR99	PEWGS6012	\$3,490.70	\$3,281.26	\$3,106.72	\$2,967.10	26	
		B/L/TTL, S, I, M	0.05	75		EAR99	PEWGS6013	\$3,803.30	\$3,575.10	\$3,384.94	\$3,232.81	27	
		B/L/S, I, M	0.05	75	12	EAR99	PEWGS6014	\$3,386.50	\$3,183.31	\$3,013.99	\$2,878.53	28	
			B/L/TTL, S, I, M	0.05	75		EAR99	PEWGS6015	\$3,386.50	\$3,183.31	\$3,013.99	\$2,878.53	29

WAVEGUIDE EMS



- Features:
- A: Absorptive
 - AR: Auto Reset
 - B: Break Before Make
 - F: Failsafe
 - D: Diode
 - GR: Global Reset
 - H: Hot Switches
 - I: Indicators
 - L: Latching
 - M: Manual Override
 - N: Normally Open
 - P: Pulse
 - R: Reflective
 - RS: Reset
 - S: Self Cut Off
 - T: Terminated
 - TTL: TTL Logic

WG Type	Switch Type	RF Freq. (GHz.)	Actuator / Features	IL (dB)	Iso (dB)	DC Power (V)	ECCN	Model No	1	2-4	5-9	10+	ROW		
WR-90	SPDT	8.2 - 12.4	B/L/S, I, M	0.07	80	28	EAR99	PEWGS6016	\$3,490.70	\$3,281.26	\$3,106.72	\$2,967.10	30		
			B/L/TTL, S, I, M	0.07	80		EAR99	PEWGS6017	\$3,490.70	\$3,281.26	\$3,106.72	\$2,967.10	31		
			B/L/S, I, M	0.07	80	EAR99	PEWGS6018	\$3,386.50	\$3,183.31	\$3,013.99	\$2,878.53	32			
WR-112		SPDT	7.05 - 10	B/L/TTL, S, I, M	0.07	80	12	EAR99	PEWGS6019	\$3,386.50	\$3,183.31	\$3,013.99	\$2,878.53	33	
				B/L/S, I, M	0.05	80		EAR99	PEWGS6020	\$3,490.70	\$3,281.26	\$3,106.72	\$2,967.10	34	
				B/L/TTL, S, I, M	0.05	80	EAR99	PEWGS6021	\$3,490.70	\$3,281.26	\$3,106.72	\$2,967.10	35		
WR-137			SPDT	5.85 - 8.2	B/L/S, I, M	0.05	80	28	EAR99	PEWGS6022	\$3,386.50	\$3,183.31	\$3,013.99	\$2,878.53	36
					B/L/TTL, S, I, M	0.05	80		EAR99	PEWGS6023	\$3,386.50	\$3,183.31	\$3,013.99	\$2,878.53	37
					B/L/S, I, M	0.02	70	28	EAR99	PEWGS6024	\$3,490.70	\$3,281.26	\$3,106.72	\$2,967.10	38
					B/L/TTL, S, I, M	0.02	70		EAR99	PEWGS6025	\$3,490.70	\$3,281.26	\$3,106.72	\$2,967.10	39
					B/L/S, I, M	0.02	70	12	EAR99	PEWGS6026	\$3,386.50	\$3,183.31	\$3,013.99	\$2,878.53	40
					B/L/TTL, S, I, M	0.02	70		EAR99	PEWGS6027	\$3,386.50	\$3,183.31	\$3,013.99	\$2,878.53	41

ELECTROMECHANICAL RELAY SWITCHES

see page [184](#)

FLEXIBLE WAVEGUIDES

Seamless

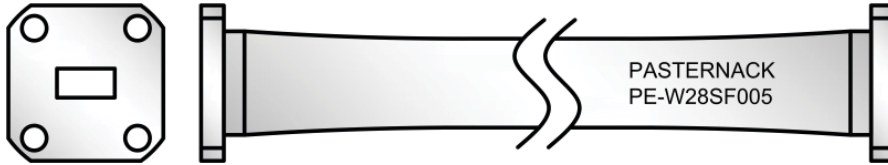

Waveguide Type	RF Frequency (GHz.)	IL (dB)	Max VSWR	Length (in)	Flange Type	ECCN	Model No	1	2-4	5-9	10+	ROW
WR-22	33 - 50	0.49	1.2:1	6	Round Cover UG-383/U	EAR99	PE-W22SF005-6	\$1,576.89	\$1,513.81	\$1,450.74	\$1,387.66	42
		0.49	1.2:1	12	Round Cover UG-383/U	EAR99	PE-W22SF005-12	\$2,493.85	\$2,394.10	\$2,294.34	\$2,194.59	43
		0.49	1.2:1	24	Round Cover UG-383/U	EAR99	PE-W22SF005-24	\$3,313.56	\$3,181.02	\$3,048.48	\$2,915.93	44
WR-28	26.5 - 40	0.49	1.2:1	12	Square Cover UG-599/U	EAR99	PE-W28SF005-12	\$1,285.13	\$1,233.72	\$1,182.32	\$1,130.91	45
		0.98	1.2:1	24	Square Cover UG-599/U	EAR99	PE-W28SF005-24	\$2,125.68	\$2,040.65	\$1,955.63	\$1,870.60	46
		1.47	1.2:1	36	Square Cover UG-599/U	EAR99	PE-W28SF005-36	\$2,966.24	\$2,847.59	\$2,728.94	\$2,610.29	47
WR-34	22 - 33	0.4	1.15:1	12	Square Cover UG-1530/U	EAR99	PE-W34SF005-12	\$1,285.13	\$1,233.72	\$1,182.32	\$1,130.91	48
		0.8	1.15:1	24	Square Cover UG-1530/U	EAR99	PE-W34SF005-24	\$2,125.68	\$2,040.65	\$1,955.63	\$1,870.60	49
		1.2	1.15:1	36	Square Cover UG-1530/U	EAR99	PE-W34SF005-36	\$2,966.24	\$2,847.59	\$2,728.94	\$2,610.29	50
WR-42	18 - 26.5	0.27	1.15:1	12	Square Cover UG-595/U	EAR99	PE-W42SF005-12	\$1,128.83	\$1,083.68	\$1,038.52	\$993.37	51
		0.54	1.15:1	24	Square Cover UG-595/U	EAR99	PE-W42SF005-24	\$1,833.92	\$1,760.56	\$1,687.21	\$1,613.85	52
		0.81	1.15:1	36	Square Cover UG-595/U	EAR99	PE-W42SF005-36	\$2,542.48	\$2,440.78	\$2,339.08	\$2,237.38	53
WR-51	15 - 22	0.18	1.1:1	12	Square Cover	EAR99	PE-W51SF005-12	\$1,139.25	\$1,093.68	\$1,048.11	\$1,002.54	54
		0.36	1.1:1	24	Square Cover	EAR99	PE-W51SF005-24	\$1,840.88	\$1,767.24	\$1,693.61	\$1,619.97	55
		0.54	1.1:1	36	Square Cover	EAR99	PE-W51SF005-36	\$2,549.44	\$2,447.46	\$2,345.48	\$2,243.51	56
WR-62	12.4 - 18	0.14	1.08:1	12	Square Cover UG-1665/U	EAR99	PE-W62SF005-12	\$1,083.68	\$1,040.33	\$996.99	\$953.64	57
		0.28	1.08:1	24	Square Cover UG-1665/U	EAR99	PE-W62SF005-24	\$1,625.52	\$1,560.50	\$1,495.48	\$1,430.46	58
		0.42	1.08:1	36	Square Cover UG-1665/U	EAR99	PE-W62SF005-36	\$2,260.32	\$2,169.91	\$2,079.49	\$1,989.08	59
WR-75	10 - 15	0.12	1.07:1	12	Square Cover	EAR99	PE-W75SF005-12	\$1,059.38	\$1,017.00	\$974.63	\$932.25	60
		0.24	1.07:1	24	Square Cover	EAR99	PE-W75SF005-24	\$1,712.22	\$1,643.73	\$1,575.24	\$1,506.75	61
		0.36	1.07:1	36	Square Cover	EAR99	PE-W75SF005-36	\$2,326.31	\$2,233.26	\$2,140.21	\$2,047.16	62
WR-90	8.2 - 12.4	0.9	1.07:1	12	CPR-90G	EAR99	PE-W90SF006-12	\$1,083.68	\$1,040.33	\$996.99	\$953.64	63
		0.18	1.07:1	24	CPR-90G	EAR99	PE-W90SF006-24	\$1,695.00	\$1,627.20	\$1,559.40	\$1,491.60	64
		0.27	1.07:1	36	CPR-90G	EAR99	PE-W90SF006-36	\$2,299.36	\$2,207.39	\$2,115.41	\$2,023.44	65
		0.09	1.07:1	12	Square Cover UG-39/U	EAR99	PE-W90SF005-12	\$1,083.68	\$1,040.33	\$996.99	\$953.64	66
		0.18	1.07:1	24	Square Cover UG-39/U	EAR99	PE-W90SF005-24	\$1,695.00	\$1,627.20	\$1,559.40	\$1,491.60	67
		0.27	1.07:1	36	Square Cover UG-39/U	EAR99	PE-W90SF005-36	\$2,299.36	\$2,207.39	\$2,115.41	\$2,023.44	68



Free Shipping Available via UPS Ground to USA & Canada



Technical Support (866) 727-8376



Same-Day Shipping, Even Custom Cable Assemblies

Seamless



Waveguide Type	RF Frequency (GHz.)	IL (dB)	Max VSWR	Length (in)	Flange Type	ECCN	Model No	1	2-4	5-9	10+	ROW
WR-112	7.05 - 10	0.08	1.07:1	12	CPR-112G	EAR99	PE-W112SF006-12	\$1,174.00	\$1,127.04	\$1,080.08	\$1,033.12	69
		0.16	1.07:1	24	CPR-112G	EAR99	PE-W112SF006-24	\$1,847.81	\$1,773.90	\$1,699.99	\$1,626.07	70
		0.24	1.07:1	36	CPR-112G	EAR99	PE-W112SF006-36	\$2,528.60	\$2,427.46	\$2,326.31	\$2,225.17	71
		0.08	1.07:1	12	Square Cover UG-51/U	EAR99	PE-W112SF005-12	\$1,174.00	\$1,127.04	\$1,080.08	\$1,033.12	72
		0.16	1.07:1	24	Square Cover UG-51/U	EAR99	PE-W112SF005-24	\$1,847.81	\$1,773.90	\$1,699.99	\$1,626.07	73
		0.24	1.07:1	36	Square Cover UG-51/U	EAR99	PE-W112SF005-36	\$2,528.60	\$2,427.46	\$2,326.31	\$2,225.17	74
WR-137	5.85 - 8.2	0.06	1.07:1	12	CPR-137G	EAR99	PE-W137SF006-12	\$1,201.77	\$1,153.70	\$1,105.63	\$1,057.56	75
		0.12	1.07:1	24	CPR-137G	EAR99	PE-W137SF006-24	\$2,031.90	\$1,950.62	\$1,869.35	\$1,788.07	76
		0.18	1.07:1	36	CPR-137G	EAR99	PE-W137SF006-36	\$2,799.52	\$2,687.54	\$2,575.56	\$2,463.58	77
		0.06	1.07:1	12	Round Cover UG-344/U	EAR99	PE-W137SF005-12	\$1,305.97	\$1,253.73	\$1,201.49	\$1,149.25	78
		0.12	1.07:1	24	Round Cover UG-344/U	EAR99	PE-W137SF005-24	\$2,077.05	\$1,993.97	\$1,910.89	\$1,827.80	79
		0.18	1.07:1	36	Round Cover UG-344/U	EAR99	PE-W137SF005-36	\$2,848.13	\$2,734.20	\$2,620.28	\$2,506.35	80

Twistable

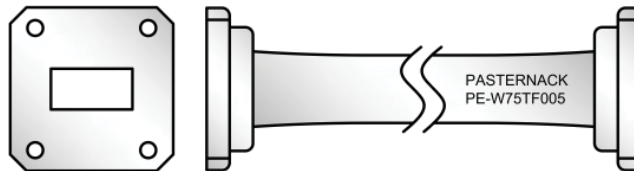

Waveguide Type	RF Frequency (GHz.)	IL (dB)	Max VSWR	Length (in)	Flange Type	ECCN	Model No	1	2-4	5-9	10+	ROW
WR-22	33 - 50	0.6	1.3:1	6	Round Cover UG-383/U	EAR99	PE-W22TF005-6	\$791.92	\$760.24	\$728.57	\$696.89	81
		0.6	1.3:1	12	Round Cover UG-383/U	EAR99	PE-W22TF005-12	\$805.81	\$773.58	\$741.35	\$709.11	82
		0.6	1.3:1	24	Round Cover UG-383/U	EAR99	PE-W22TF005-24	\$847.49	\$813.59	\$779.69	\$745.79	83
WR-28	26.5 - 40	0.6	1.3:1	12	Square Cover UG-599/U	EAR99	PE-W28TF005-12	\$487.66	\$468.15	\$448.65	\$429.14	84
		1.2	1.3:1	24	Square Cover UG-599/U	EAR99	PE-W28TF005-24	\$527.75	\$506.64	\$485.53	\$464.42	85
		1.8	1.3:1	36	Square Cover UG-599/U	EAR99	PE-W28TF005-36	\$549.08	\$527.12	\$505.15	\$483.19	86
WR-34	22 - 33	0.5	1.22:1	12	Square Cover UG-1530/U	EAR99	PE-W34TF005-12	\$485.08	\$465.68	\$446.27	\$426.87	87
		1	1.22:1	24	Square Cover UG-1530/U	EAR99	PE-W34TF005-24	\$510.23	\$489.82	\$469.41	\$449.00	88
		1.5	1.22:1	36	Square Cover UG-1530/U	EAR99	PE-W34TF005-36	\$546.16	\$524.31	\$502.47	\$480.62	89
WR-42	18 - 26.5	0.35	1.3:1	12	Square Cover UG-595/U	EAR99	PE-W42TF005-12	\$423.99	\$407.03	\$390.07	\$373.11	90
		0.7	1.3:1	24	Square Cover UG-595/U	EAR99	PE-W42TF005-24	\$445.55	\$427.73	\$409.91	\$392.08	91
		1.05	1.35:1	36	Square Cover UG-595/U	EAR99	PE-W42TF005-36	\$484.06	\$464.70	\$445.34	\$425.97	92
WR-51	15 - 22	0.55	1.15:1	12	Square Cover	EAR99	PE-W51TF005-12	\$474.30	\$455.33	\$436.36	\$417.38	93
		1.1	1.15:1	24	Square Cover	EAR99	PE-W51TF005-24	\$493.21	\$473.48	\$453.75	\$434.02	94
		1.65	1.15:1	36	Square Cover	EAR99	PE-W51TF005-36	\$521.00	\$500.16	\$479.32	\$458.48	95
WR-62	12.4 - 18	0.28	1.1:1	12	Square Cover UG-1665/U	EAR99	PE-W62TF005-12	\$510.23	\$489.82	\$469.41	\$449.00	96
		0.56	1.1:1	24	Square Cover UG-1665/U	EAR99	PE-W62TF005-24	\$560.54	\$538.12	\$515.70	\$493.28	97
		0.84	1.1:1	36	Square Cover UG-1665/U	EAR99	PE-W62TF005-36	\$610.84	\$586.41	\$561.97	\$537.54	98
WR-75	10 - 15	0.18	1.1:1	12	Square Cover	EAR99	PE-W75TF005-12	\$541.84	\$520.17	\$498.49	\$476.82	99
		0.36	1.1:1	24	Square Cover	EAR99	PE-W75TF005-24	\$567.72	\$545.01	\$522.30	\$499.59	1
		0.54	1.1:1	36	Square Cover	EAR99	PE-W75TF005-36	\$628.80	\$603.65	\$578.50	\$553.34	2
WR-90	8.2 - 12.4	0.15	1.07:1	12	CPR-90G	EAR99	PE-W90TF006-12	\$493.21	\$473.48	\$453.75	\$434.02	3
		0.3	1.07:1	24	CPR-90G	EAR99	PE-W90TF006-24	\$582.10	\$558.82	\$535.53	\$512.25	4
		0.45	1.07:1	36	CPR-90G	EAR99	PE-W90TF006-36	\$632.16	\$606.87	\$581.59	\$556.30	5
		0.15	1.1:1	12	Square Cover UG-39/U	EAR99	PE-W90TF005-12	\$510.23	\$489.82	\$469.41	\$449.00	6
		0.36	1.1:1	24	Square Cover UG-39/U	EAR99	PE-W90TF005-24	\$582.10	\$558.82	\$535.53	\$512.25	7
		0.45	1.1:1	36	Square Cover UG-39/U	EAR99	PE-W90TF005-36	\$657.44	\$631.14	\$604.84	\$578.55	8
WR-112	7.05 - 10	0.12	1.07:1	12	CPR-112G	EAR99	PE-W112TF006-12	\$582.10	\$558.82	\$535.53	\$512.25	9
		0.24	1.07:1	24	CPR-112G	EAR99	PE-W112TF006-24	\$671.89	\$645.01	\$618.14	\$591.26	10
		0.36	1.07:1	36	CPR-112G	EAR99	PE-W112TF006-36	\$701.61	\$673.55	\$645.48	\$617.42	11
		0.12	1.3:1	12	Square Cover UG-51/U	EAR99	PE-W112TF005-12	\$582.10	\$558.82	\$535.53	\$512.25	12
		0.24	1.07:1	24	Square Cover UG-51/U	EAR99	PE-W112TF005-24	\$657.44	\$631.14	\$604.84	\$578.55	13
		0.36	1.07:1	36	Square Cover UG-51/U	EAR99	PE-W112TF005-36	\$701.61	\$673.55	\$645.48	\$617.42	14
WR-137	5.85 - 8.2	0.07	1.05:1	12	CPR-137G	EAR99	PE-W137TF006-12	\$560.54	\$538.12	\$515.70	\$493.28	15
		0.14	1.05:1	24	CPR-137G	EAR99	PE-W137TF006-24	\$657.44	\$631.14	\$604.84	\$578.55	16
		0.21	1.05:1	36	CPR-137G	EAR99	PE-W137TF006-36	\$751.36	\$721.31	\$691.25	\$661.20	17

See Our Website For Current Pricing & Real-Time Stock Availability!

Waveguides

Twistable

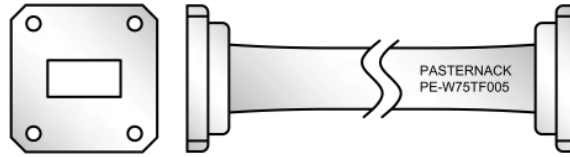

Waveguide Type	RF Frequency (GHz.)	IL (dB)	Max VSWR	Length (in)	Flange Type	ECCN	Model No	1	2-4	5-9	10+	ROW
WR-137	5.85 - 8.2	0.07	1.05:1	12	Round Cover UG-344/U	EAR99	PE-W137TF005-12	\$632.16	\$606.87	\$581.59	\$556.30	18
		0.14	1.05:1	24	Round Cover UG-344/U	EAR99	PE-W137TF005-24	\$722.45	\$693.55	\$664.65	\$635.76	19
		0.18	1.05:1	36	Round Cover UG-344/U	EAR99	PE-W137TF005-36	\$812.76	\$780.25	\$747.74	\$715.23	20

WAVEGUIDE GUNN OSCILLATORS

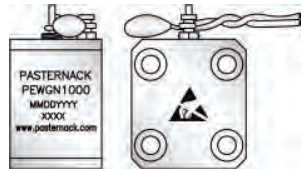

WG Type	Center Freq. (GHz.)	Tuning Range (GHz.)	Freq. Stability (MHz/deg C)	Phase Noise (dBc/Hz)	Output Power (dBm)	Flange Type	ECCN	Model No	1	2-4	5-9	10+	ROW
WR-28	35	3	-0.4	-95	10	Square Cover UG-599/U	EAR99	PEWGN1000	\$329.96	\$310.16	\$293.66	\$280.47	21
WR-42	24.125	1,000 MHz	-0.2	-98	10	Square Cover UG-595/U	EAR99	PEWGN1001	\$295.23	\$277.52	\$262.75	\$250.95	22

WAVEGUIDE MAGIC TEES

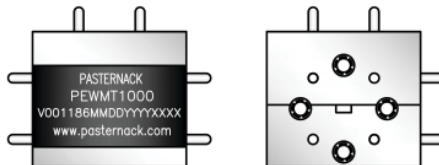

Waveguide Type	RF Frequency (GHz.)	Flange Type	IL (dB)	Min Isolation (dB)	ECCN	Model No	1	2-4	5-9	10+	ROW
WR-10	75 - 110	Round Cover UG-387/U-Mod	1	25	EAR99	PEWMT1000	\$2,480.97	\$2,381.73	\$2,282.49	\$2,183.25	23
WR-12	60 - 90	Round Cover UG-387/U			EAR99	PEWMT1001	\$2,506.48	\$2,406.22	\$2,305.96	\$2,205.70	24
WR-15	50 - 75	Round Cover UG-385/U			EAR99	PEWMT1002	\$2,377.47	\$2,282.37	\$2,187.27	\$2,092.17	25
WR-19	40 - 60	Round Cover UG-383/U-Mod	0.8	25	EAR99	PEWMT1003	\$2,144.26	\$2,058.49	\$1,972.72	\$1,886.95	26
WR-22	33 - 50	Round Cover UG-383/U	0.7		EAR99	PEWMT1004	\$2,144.26	\$2,058.49	\$1,972.72	\$1,886.95	27
WR-28	26.5 - 40	Square Cover UG-599/U	0.5		EAR99	PEWMT1005	\$2,042.54	\$1,960.84	\$1,879.14	\$1,797.44	28
WR-42	18 - 26.5	Square Cover UG-595/U		EAR99	PEWMT1006	\$2,002.49	\$1,922.39	\$1,842.29	\$1,762.19	29	

PasterFact™:
Satellites travel at 18,000 miles per hour.
That means in a given day, satellites can travel the entire circumference of the Earth about 14 times.



Free Shipping Available
via UPS Ground
to USA & Canada



Technical
Support
(866) 727-8376



Same-Day Shipping,
Even Custom
Cable Assemblies

WAVEGUIDE PHASE SHIFTERS

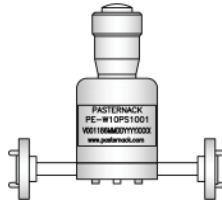

WG Type	RF Freq. (GHz.)	Phase Range (GHz.)	Input Power (Watts)	IL (dB)	Length (in)	Flange Type	ECCN	Model No	1	2-4	5-9	10+	ROW
WR-10	75 - 110	0 - 180°	0.6	1	3	Round Cover UG-387/U-Mod	EAR99	PE-W10PS1001	\$2,091.09	\$2,007.45	\$1,923.80	\$1,840.16	30
WR-12	60 - 90	0 - 180°	0.7	1	3	Round Cover UG-387/U	EAR99	PE-W12PS1001	\$2,091.09	\$2,007.45	\$1,923.80	\$1,840.16	31
WR-15	50 - 75	0 - 180°	0.8	1	3	Round Cover UG-385/U	EAR99	PE-W15PS1001	\$2,091.09	\$2,007.45	\$1,923.80	\$1,840.16	32
WR-19	40 - 60	0 - 180°	1	1	3	Round Cover UG-383/U-Mod	EAR99	PE-W19PS1001	\$2,091.09	\$2,007.45	\$1,923.80	\$1,840.16	33
WR-22	33 - 50	0 - 180°	1	1	4	Round Cover UG-383/U	EAR99	PE-W22PS1001	\$2,091.09	\$2,007.45	\$1,923.80	\$1,840.16	34
WR-28	26.5 - 40	0 - 180°	1	1	4	Square Cover UG-599/U	EAR99	PE-W28PS1001	\$2,132.92	\$2,047.60	\$1,962.29	\$1,876.97	35
WR-42	18 - 26.5	0 - 180°	1.5	1	4	Square Cover UG-595/U	EAR99	PE-W42PS1001	\$2,091.09	\$2,007.45	\$1,923.80	\$1,840.16	36

WAVEGUIDE PIN DIODE SWITCHES

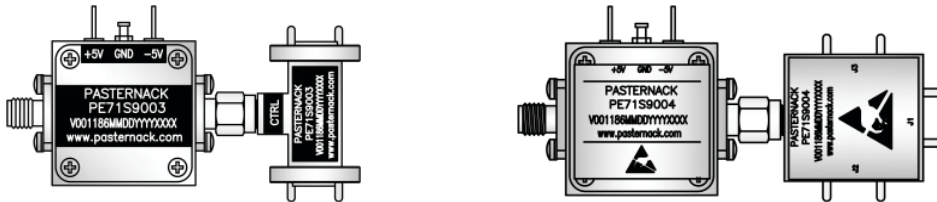

WG Type	Switch Type	RF Freq. (GHz.)	IL (dB)	Min Isolation (dB)	Max Switching (in)	Flange Type	ECCN	Model No	1	2-4	5-9	10+	ROW
WR-10	SPST/ Reflective SPDT/ Reflective	75 - 110	5.5	20	300	Round Cover UG-387/U	EAR99	PE71S9003	\$8,336.00	\$7,835.84	\$7,419.04	\$7,085.60	37
			7	20	300	Round Cover UG-387/U	EAR99	PE71S9004	\$9,899.00	\$9,305.06	\$8,810.11	\$8,414.15	38
WR-12	SPST/ Reflective SPDT/ Reflective	60 - 90	4.5	20	300	Round Cover UG-387/U	EAR99	PE71S9001	\$7,640.99	\$7,182.53	\$6,800.48	\$6,494.84	39
			6	20	300	Round Cover UG-387/U	EAR99	PE71S9002	\$9,031.02	\$8,489.16	\$8,037.61	\$7,676.37	40

PIN DIODE SWITCHES, see page [190](#)

WAVEGUIDE POWER AMPLIFIERS



Waveguide Type	RF Frequency (GHz.)	Min Gain (dB)	P _{sat} (dBm)	Flange Type	ECCN	Model No	1	2-4	5-9	10+	ROW
WR-12	70.5 - 76.5	25	20	Round Cover UG-387/U	EAR99	PE15A4023	\$10,766.99	\$10,120.97	\$9,582.62	\$9,151.94	41
	80.5 - 86.5	20	19	Round Cover UG-387/U	EAR99	PE15A4024	\$11,201.50	\$10,529.41	\$9,969.34	\$9,521.28	42

WAVEGUIDE SECTIONS

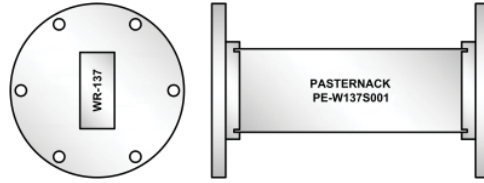

See Our Website For Current Pricing & Real-Time Stock Availability!

WG Type	RF Freq. (GHz.)	IL (dB)	Max VSWR	Length (in)	Flange Type	ECCN	Model No	1 Pc. Price	See Web for Volume Pricing	ROW
WR-10	75 - 110			3	Round Cover UG-387/U-Mod	EAR99	PE-W10S001-3	\$468.28		43
				6		EAR99	PE-W10S001-6	\$472.37		44
WR-12	60 - 90	0.82		12	Round Cover UG-387/U	EAR99	PE-W12S001-12	\$488.44		45
		0.25		3		EAR99	PE-W12S001-3	\$359.02		46
		0.44		6		EAR99	PE-W12S001-6	\$406.38		47
				9		EAR99	PE-W12S001-9	\$470.38		48
WR-15	50 - 75	0.64		12	Round Cover UG-385/U	EAR99	PE-W15S001-12	\$543.03		49
		0.2		3		EAR99	PE-W15S001-3	\$383.74		50
		0.34		6		EAR99	PE-W15S001-6	\$419.94		51
		0.49		9		EAR99	PE-W15S001-9	\$459.92		52
WR-19	40 - 60	0.44		12	Round Cover UG-383/U-Mod	EAR99	PE-W19S001-12	\$522.64		53
		0.15		3		EAR99	PE-W19S001-3	\$356.31		54
		0.25		6		EAR99	PE-W19S001-6	\$404.18		55
		0.34		9		EAR99	PE-W19S001-9	\$459.92		56
WR-22	33 - 50	0.36	1.06:1	12	Round Cover UG-383/U	EAR99	PE-W22S001-12	\$505.22		57
		0.13		3		EAR99	PE-W22S001-3	\$352.94		58
		0.21		6		EAR99	PE-W22S001-6	\$371.22		59
		0.29		9		EAR99	PE-W22S001-9	\$420.07		60
WR-28	26.5 - 40	0.28		12	Square Cover UG-599/U	EAR99	PE-W28S001-12	\$524.92		61
		0.11		3		EAR99	PE-W28S001-3	\$363.03		62
		0.17		6		EAR99	PE-W28S001-6	\$405.46		63
		0.22		9		EAR99	PE-W28S001-9	\$435.54		64
WR-42	18 - 26.5	0.12		12	Square Cover UG-595/U	EAR99	PE-W42S001-12	\$524.92		65
		0.15		6		EAR99	PE-W42S001A-6	\$365.40		66
		0.08		9		EAR99	PE-W42S001A-9	\$407.04		67
		0.13		3		EAR99	PE-W42S002-3	\$379.85		68
WR-51	15 - 22	0.07		12	UBR180	EAR99	PE-W51S001-12	\$495.97		69
		0.09		3		EAR99	PE-W51S001-3	\$376.17		70
				6		EAR99	PE-W51S001-6	\$365.40		71
		0.11		9		EAR99	PE-W51S001-9	\$394.02		72
WR-62	12.4 - 18	0.08		12	Square Cover UG-419/U	EAR99	PE-W62S002-12	\$571.02		73
		0.1		6		EAR99	PE-W62S002-6	\$450.15		74
				9		EAR99	PE-W62S002-9	\$504.33		75
				12		EAR99	PE-W62S001-12	\$332.78		76
WR-75	10 - 15			3	UBR120	EAR99	PE-W62S001-3	\$312.60		77
				6		EAR99	PE-W62S001-6	\$319.34		78
				9		EAR99	PE-W62S001-9	\$326.06		79
				12		EAR99	PE-W75S001-12	\$294.75		80
WR-90	8.2 - 12.4			3	Square Cover UG-39/U	EAR99	PE-W75S001-3	\$302.53		81
				6		EAR99	PE-W75S001-6	\$312.60		82
				9		EAR99	PE-W75S001-9	\$319.34		83
				12		EAR99	PE-W90S001-12	\$249.52		84
WR-112	7.05 - 10			3	CPR-90G	EAR99	PE-W90S001-3	\$205.05		85
				6		EAR99	PE-W90S001-6	\$208.40		86
				9		EAR99	PE-W90S001-9	\$238.66		87
				12		EAR99	PE-W90S002-12	\$309.62		88
WR-137	5.85 - 8.2			3	Square Cover UG-51/U	EAR99	PE-W90S002-3	\$276.87		89
				6		EAR99	PE-W90S002-6	\$303.14		90
				9		EAR99	PE-W90S002-9	\$297.71		91
				12		EAR99	PE-W112S001-12	\$321.53		92
WR-22	33 - 50			3	Round Cover UG-344/U	EAR99	PE-W112S001-3	\$315.97		93
				6		EAR99	PE-W112S001-6	\$303.68		94
				9		EAR99	PE-W112S001-9	\$352.94		95
				12		EAR99	PE-W137S001-12	\$383.58		96
WR-28	26.5 - 40			3	CPR-137G	EAR99	PE-W137S001-3	\$337.18		97
				6		EAR99	PE-W137S001-6	\$339.39		98
				9		EAR99	PE-W137S001-9	\$371.21		99
				12		EAR99	PE-W137S002-12	\$400.01		1
WR-34	20 - 33			3	Square Cover UG-383/U	EAR99	PE-W137S002-3	\$336.14		2
				6		EAR99	PE-W137S002-6	\$363.03		3
				9		EAR99	PE-W137S002-9	\$349.55		4
				12		EAR99	PEWSP1000	\$590.48		5
				4	Square Cover UG-599/U	EAR99	PEWSP1001	\$521.00		6
					Square Cover UG-1530/U	EAR99	PEWSP1002	\$538.38		7

See Web for Volume Pricing

Waveguides



Free Shipping Available via UPS Ground to USA & Canada



Technical Support (866) 727-8376



Same-Day Shipping, Even Custom Cable Assemblies

WAVEGUIDE SECTIONS

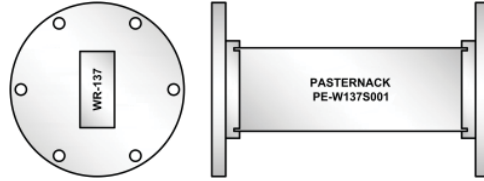

WG Type	RF Freq. (GHz.)	IL (dB)	Max VSWR	Length (in)	Flange Type	ECCN	Model No	1 Pc. Price	See Web for Volume Pricing	ROW
WR-42	18 - 26.5			4	Square Cover UG-595/U	EAR99	PEWSP1003	\$521.00	See Web for Volume Pricing	8
WR-51	15 - 22				Square Cover	EAR99	PEWSP1004	\$555.75		9
WR-62	12.4 - 18				Square Cover UG-419/U	EAR99	PEWSP1005	\$527.96		10
WR-75	10 - 15				Square Cover	EAR99	PEWSP1006	\$538.38		11
WR-90	8.2 - 12.4				Square Cover UG-39/U	EAR99	PEWSP1007	\$555.75		12
					CPR-90G	EAR99	PEWSP1008	\$562.68		13
WR-112	7.05 - 10				Square Cover UG-51/U	EAR99	PEWSP1009	\$573.10		14
					CPR-112G	EAR99	PEWSP1010	\$576.59		15
WR-137	5.85 - 8.2				Round Cover UG-344/U	EAR99	PEWSP1011	\$597.43		16
					CPR-137G	EAR99	PEWSP1012	\$583.52		17

WAVEGUIDE TERMINATIONS

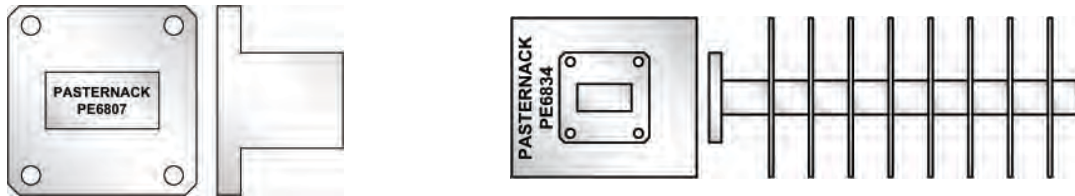

Waveguide Type	RF Frequency (GHz.)	Input Power (Watts)	Max VSWR	Length (in)	Flange Type	ECCN	Model No	1 Pc. Price	See Web for Volume Pricing	ROW
WR-10	75 - 110	0.4	1.25:1	2	Round Cover UG-387/U-Mod	EAR99	PE-W10TR1001	\$500.59	See Web for Volume Pricing	18
WR-12	60 - 90	0.6	1.2:1		Round Cover UG-387/U	EAR99	PE-W12TR1001	\$500.59		19
WR-15	50 - 75	1	1.2:1		Round Cover UG-385/U	EAR99	PE-W15TR1001	\$500.59		20
WR-19	40 - 60	2	1.09:1		Round Cover UG-383/U-Mod	EAR99	PE-W19TR1001	\$467.84		21
WR-22	33 - 50	4	1.07:1		Round Cover UG-383/U	EAR99	PE-W22TR1001	\$467.84		22
WR-28	26.5 - 40	0.5	1.3:1	1	Square Cover UG-599/U	EAR99	PE6800	\$398.15	23	
		0.5	1.05:1	2	Square Cover	EAR99	PE6809	\$784.63	24	
		0.5	1.02:1		Square Cover UG-599/U	EAR99	PEWTR1000	\$632.16	25	
		5	1.07:1	2	Square Cover UG-599/U	EAR99	PE-W28TR1001	\$500.59	26	
		40	1.07:1	3	Square Cover	EAR99	PE6818	\$874.78	27	
WR-34	22 - 33	75	1.2:1	4	Square Cover	EAR99	PE6200	\$795.43	28	
		0.5	1.25:1	1	Square Cover	EAR99	PE6801	\$289.62	29	
		0.5	1.05:1	3	Square Cover	EAR99	PE6810	\$754.44	30	
		1	1.25:1		Square Cover UG-1530/U	EAR99	PEWTR1001	\$583.52	31	
		40	1.07:1	4	Square Cover	EAR99	PE6819	\$1,224.17	32	
WR-42	18 - 26.5	75	1.1:1	4	Square Cover	EAR99	PE6828	\$1,141.52	33	
		0.5	1.25:1	1	Square Cover UG-597/U	EAR99	PE6802	\$388.80	34	
		0.5	1.05:1	3	Square Cover	EAR99	PE6811	\$863.82	35	
		1	1.02:1		Square Cover UG-595/U	EAR99	PEWTR1002	\$548.80	36	
		6	1.08:1	3	Square Cover UG-595/U	EAR99	PE-W42TR1001	\$500.59	37	
WR-51	15 - 18	50	1.07:1	4	Square Cover	EAR99	PE6820	\$856.11	38	
		100	1.1:1	4	Square Cover	EAR99	PE6829	\$879.63	39	
		1	1.2:1	1	Square Cover	EAR99	PE6803	\$356.69	40	
		1	1.05:1	3	Square Cover	EAR99	PE6812	\$955.07	41	
		1	1.02:1		Square Cover	EAR99	PEWTR1003	\$569.64	42	
WR-62	12.4 - 18	55	1.07:1	4	Square Cover	EAR99	PE6821	\$856.11	43	
		100	1.1:1	4	Square Cover	EAR99	PE6830	\$1,187.18	44	
		1.5	1.05:1		Square Cover	EAR99	PE6201	\$946.28	45	
		1.5	1.02:1		Square Cover UG-419/U	EAR99	PEWTR1004	\$534.89	46	
		2	1.2:1	1	Square Cover	EAR99	PE6804	\$380.99	47	
WR-62	12.4 - 18	60	1.07:1	4	Square Cover	EAR99	PE6836	\$803.06	48	
		175	1.1:1	4	Square Cover	EAR99	PE6831	\$1,141.52	49	

WAVEGUIDE TERMINATIONS

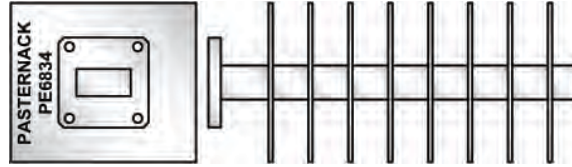
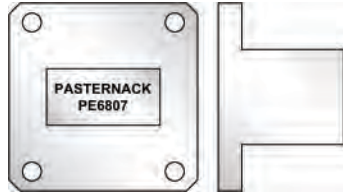

Waveguide Type	RF Frequency (GHz.)	Input Power (Watts)	Max VSWR	Length (in)	Flange Type	ECCN	Model No	1 Pc. Price	See Web for Volume Pricing	ROW
WR-75	10 - 15	2	1.2:1	1	Square Cover	EAR99	PE6805	\$597.25	See Web for Volume Pricing	50
		2	1.05:1	4	Square Cover	EAR99	PE6814	\$741.97		51
		2.5	1.02:1		Square Cover	EAR99	PEWTR1005	\$576.06		52
		75	1.07:1	5	Square Cover	EAR99	PE6823	\$742.74		53
		175	1.1:1	6	Square Cover	EAR99	PE6832	\$1,244.62		54
WR-90	8.2 - 12.4	2	1.2:1	1	Square Cover UG-135/U	EAR99	PE6806	\$445.23		55
		2	1.05:1	4	Square Cover	EAR99	PE6815	\$741.97		56
		4	1.02:1		Square Cover UG-39/U	EAR99	PEWTR1006	\$527.96		57
		4	1.02:1		CPR-90G	EAR99	PEWTR1007	\$538.38		58
		90	1.07:1	6	Square Cover	EAR99	PE6824	\$1,068.78		59
		200	1.1:1		Square Cover	EAR99	PE6833	\$1,417.68		60
WR-102	7 - 11	2	1.2:1	1	Square Cover	EAR99	PE6807	\$408.11	61	
		2	1.05:1	4	Square Cover	EAR99	PE6816	\$713.43	62	
		300	1.1:1	7	Square Cover	EAR99	PE6834	\$1,479.33	63	
WR-112	7.05 - 10	2	1.2:1	1	Square Cover	EAR99	PE6808	\$428.10	64	
		2	1.05:1	5	Square Cover	EAR99	PE6817	\$713.43	65	
		5	1.02:1		Square Cover UG-51/U	EAR99	PEWTR1008	\$562.68	66	
		5	1.02:1		CPR-112G	EAR99	PEWTR1009	\$609.51	67	
		100	1.07:1	7	Square Cover	EAR99	PE6826	\$998.89	68	
		300	1.1:1		Square Cover	EAR99	PE6835	\$1,978.76	69	
WR-137	5.85 - 8.2	6	1.02:1		Round Cover UG-344/U	EAR99	PEWTR1010	\$593.94	70	
		6	1.02:1		CPR-137G	EAR99	PEWTR1011	\$597.41	71	

WAVEGUIDE TO COAX ADAPTERS



SMA Male



N Female

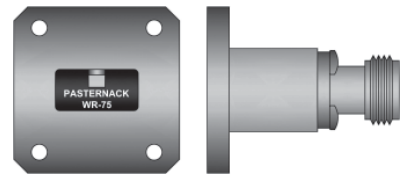

N Female

WG Type	RF Freq. (GHz.)	IL (dB)	Max VSWR	Flange Type	Connector	ECCN	Model No	1 Pc. Price	See Web for Volume Pricing	ROW
WR-10	75 - 110	1	1.9:1	Round Cover UG-387/U-Mod	1.0mm Female	EAR99	PE-W10CA001	\$5,210.00	See Web for Volume Pricing	72
					1.0mm Male	EAR99	PE-W10CA002	\$5,210.00		73
WR-12	60 - 90	1	1.67:1	Round Cover UG-387/U	1.0mm Female	EAR99	PE-W12CA001	\$5,199.79		74
					1.0mm Male	EAR99	PE-W12CA002	\$5,036.33		75
WR-15	50 - 65	0.5	1.44:1	Round Cover UG-385/U	1.85mm Female	EAR99	PE-W15CA001	\$1,403.93		76
					1.85mm Male	EAR99	PE-W15CA002	\$1,446.42		77
WR-19	40 - 60	0.4	1.38:1	Round Cover UG-383/U-Mod	1.85mm Female	EAR99	PE-W19CA001	\$1,509.18		78
					1.85mm Male	EAR99	PE-W19CA002	\$1,371.98		79
WR-22	33 - 50	0.4	1.33:1	Round Cover UG-383/U	2.4mm Female	EAR99	PE-W22CA001	\$1,451.87		80
					2.4mm Male	EAR99	PE-W22CA002	\$1,319.88		81
WR-28	26.5 - 40	0.35	1.29:1	Square Cover UG-599/U	2.92mm Female	EAR99	PE-W28CA001	\$719.16		82
					2.92mm Male	EAR99	PE-W28CA002	\$762.91	83	
					2.92mm Female	EAR99	PEWCA1000	\$824.73	84	
		0.3	1.3:1	Square Cover	2.92mm Female	EAR99	PEWCA1020	\$618.25	85	
					2.92mm Female	EAR99	PE9826	\$474.45	86	
WR-34	22 - 33	0.3	1.25:1	Square Cover UG-1530/U	2.92mm Female	EAR99	PEWCA1001	\$708.58	87	
					2.92mm Female	EAR99	PEWCA1021	\$583.52	88	
WR-42	18 - 26.5	0.75	1.4:1	Square Cover	2.92mm Female	EAR99	PE9827	\$827.54	89	
					2.92mm Female	EAR99	PEWCA1018	\$741.91	90	
		0.3	1.25:1	Square Cover UG-595/U	2.92mm Female	EAR99	PEWCA1019	\$502.97	91	
					2.92mm Female	EAR99	PE-W42CA001	\$762.91	92	
				2.92mm Male	EAR99	PE-W42CA002	\$762.91	93		



Free Shipping Available via UPS Ground to USA & Canada



Technical Support (866) 727-8376



Same-Day Shipping, Even Custom Cable Assemblies

WAVEGUIDE TO COAX ADAPTERS



SMA Male



N Female



N Female

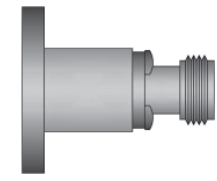

WG Type	RF Freq. (GHz.)	IL (dB)	Max VSWR	Flange Type	Connector	ECCN	Model No	1 Pc. Price	See Web for Volume Pricing	ROW
WR-42	18 - 26.5	0.3	1.3:1	Square Cover UG-597/U	2.92mm Female	EAR99	PEWCA1022	\$489.74	See Web for Volume Pricing	94
				Square Cover	2.92mm Female	EAR99	PE9878	\$511.12		95
WR-51	15 - 22	0.3	1.4:1	Square Cover UG-595/U	2.92mm Male	EAR99	PE9813A	\$610.70		96
				Square Type	2.92mm Female	EAR99	PE9812	\$450.33		97
WR-62	12.4 - 18	0.3	1.25:1	Square Cover	SMA Female	EAR99	PEWCA1002	\$527.96		98
				Square Type	SMA Female	EAR99	PEWCA1027	\$736.36		99
WR-75	10 - 15	0.3	1.3:1	Square Type	SMA Female	EAR99	PE9828	\$508.12		1
				Square Type	SMA Female	EAR99	PE9879	\$728.56		2
WR-90	8.2 - 12.4	0.3	1.2:1	Square Cover UG-1665/U	SMA Male	EAR99	PE9809	\$371.67		3
				Square Cover UG-1665/U	SMA Female	EAR99	PEWCA1003	Call		4
WR-102	7 - 11	0.3	1.25:1	Square Cover UG-1665/U	SMA Female	EAR99	PEWCA1023	\$430.69		5
				Square Type	SMA Female	EAR99	PE9803	\$373.66		6
WR-112	7.05 - 10	0.3	1.4:1	Square Type	N Male	EAR99	PE9806	\$516.17		7
				Square Type	SMA Female	EAR99	PE9846	\$550.96		8
WR-122	7.05 - 10	0.3	1.4:1	Square Type	N Female	EAR99	PE9866	\$663.27		9
				Square Type	N Female	EAR99	PE9875	\$357.25		10
WR-132	7.05 - 10	0.3	1.25:1	Square Cover	SMA Female	EAR99	PEWCA1004	\$583.54		11
				Square Cover	N Female	EAR99	PEWCA1005	\$641.88		12
WR-142	7.05 - 10	0.3	1.25:1	Square Cover	SMA Female	EAR99	PEWCA1024	\$409.85		13
				Square Cover	N Female	EAR99	PEWCA1029	\$656.46		14
WR-152	7.05 - 10	0.3	1.3:1	Square Type	SMA Female	EAR99	PE9819	\$360.87		15
				Square Type	N Female	EAR99	PE9874	\$436.38		16
WR-162	7.05 - 10	0.3	1.4:1	Square Type	SMA Female	EAR99	PE9847	\$602.50		17
				Square Type	N Female	EAR99	PE9867	\$652.96		18
WR-172	7.05 - 10	0.3	1.2:1	Square Cover	7mm Sexless	EAR99	PE9815	\$751.06		19
				Square Cover	SMA Female	EAR99	PEWCA1032	\$659.93		20
WR-182	7.05 - 10	0.3	1.25:1	CMR-90	N Female	EAR99	PEWCA1033	\$659.93		21
				CPR-90G	SMA Female	EAR99	PEWCA1007	\$503.63		22
WR-192	7.05 - 10	0.3	1.25:1	CPR-90G	N Female	EAR99	PEWCA1009	\$541.84	23	
				CPR-90G	SMA Female	EAR99	PEWCA1034	\$639.09	24	
WR-202	7.05 - 10	0.3	1.25:1	Square Cover UG-135/U	N Female	EAR99	PEWCA1036	\$666.88	25	
				Square Cover UG-135/U	N Female	EAR99	PE9868	\$703.19	26	
WR-212	7.05 - 10	0.3	1.25:1	Square Cover UG-135/U	SMA Female	EAR99	PEWCA1025	\$399.43	27	
				Square Cover UG-135/U	N Female	EAR99	PEWCA1031	\$666.88	28	
WR-222	7.05 - 10	0.3	1.25:1	Square Cover UG-39/U	SMA Female	EAR99	PEWCA1006	\$604.36	29	
				Square Cover UG-39/U	N Female	EAR99	PEWCA1008	\$650.21	30	
WR-232	7.05 - 10	0.3	1.25:1	UDR100	N Female	EAR99	PE9883	\$354.33	31	
				CPR-90G	N Female	EAR99	PE9873	\$447.97	32	
WR-242	7.05 - 10	0.3	1.3:1	Square Type	N Female	EAR99	PE9801	\$364.79	33	
				Square Type	N Female	EAR99	PE9804	\$354.26	34	
WR-252	7.05 - 10	0.3	1.3:1	Square Type	SMA Male	EAR99	PE9810	\$427.54	35	
				Square Type	SMA Female	EAR99	PE9848	\$531.12	36	
WR-262	7.05 - 10	0.3	1.3:1	Square Type	N Male	EAR99	PE9889	\$413.15	37	
				Square Type	N Female	EAR99	PE9869	\$441.19	38	
WR-272	7.05 - 10	0.3	1.25:1	Square Cover UG-1493/U	SMA Female	EAR99	PE9805	\$513.72	39	
				Square Cover	SMA Male	EAR99	PE9811	\$264.90	40	
WR-282	7.05 - 10	0.3	1.3:1	Square Type	N Female	EAR99	PE9802	\$458.07	41	
				Square Type	N Male	EAR99	PE9890	\$413.15	42	
WR-292	7.05 - 10	0.3	1.4:1	Square Type	SMA Female	EAR99	PE9871	\$419.21	43	
				Square Type	SMA Female	EAR99	PEWCA1042	\$659.93	44	
WR-302	7.05 - 10	0.3	1.25:1	CMR-112	N Female	EAR99	PEWCA1043	\$659.93	45	
				CPR-112G	SMA Female	EAR99	PEWCA1011	\$641.88	46	
WR-312	7.05 - 10	0.3	1.25:1	CPR-112G	N Female	EAR99	PEWCA1013	\$548.80	47	
				CPR-112G	SMA Female	EAR99	PEWCA1044	\$656.46	48	
WR-322	7.05 - 10	0.3	1.25:1	Square Cover UG-138/U	N Female	EAR99	PEWCA1045	\$673.84	49	
				Square Cover UG-138/U	SMA Female	EAR99	PEWCA1040	\$656.46	50	
WR-332	7.05 - 10	0.3	1.25:1	Square Cover UG-51/U	N Female	EAR99	PEWCA1041	\$673.84	51	
				Square Cover UG-51/U	SMA Female	EAR99	PEWCA1010	\$641.88	52	
WR-342	7.05 - 10	0.3	1.3:1	CPR-112G	N Female	EAR99	PEWCA1012	\$658.56	53	
				CPR-112G	N Female	EAR99	PE9837	\$569.11	54	
WR-352	7.05 - 10	0.3	1.3:1	Square Type	N Female	EAR99	PE9820	\$370.67	55	
				Square Type	N Female	EAR99	PE9870	\$513.05	56	
WR-362	7.05 - 10	0.3	1.4:1	Square Type	SMA Female	EAR99	PE9884	\$347.06	57	
				Square Type	SMA Female	EAR99	PE9865	\$595.38	58	

WAVEGUIDE TO COAX ADAPTERS



SMA Male

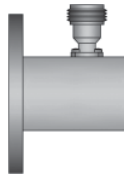

N Female

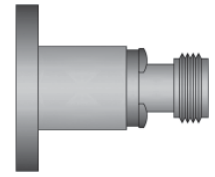

N Female

WG Type	RF Freq. (GHz.)	IL (dB)	Max VSWR	Flange Type	Connector	ECCN	Model No	1 Pc. Price	See Web for Volume Pricing	ROW				
WR-137	5.85 - 8.2		1.25:1	CMR-137	SMA Female	EAR99	PEWCA1048	\$677.30	See Web for Volume Pricing	59				
					N Female	EAR99	PEWCA1049	\$677.30		60				
					CPR-137G	SMA Female	EAR99	PEWCA1015		\$555.73	61			
						N Female	EAR99	PEWCA1017		\$559.22	62			
						SMA Female	EAR99	PEWCA1050		\$677.30	63			
						N Female	EAR99	PEWCA1051		\$680.77	64			
				Round Cover UG-344/U	SMA Female	EAR99	PEWCA1014	\$555.73		65				
					N Female	EAR99	PEWCA1016	\$671.06		66				
				Round Cover UG-441/U	SMA Female	EAR99	PEWCA1046	\$677.30		67				
					N Female	EAR99	PEWCA1047	\$680.77		68				
				WR-159	4.9 - 7.05		1.3:1	CMR-137		SMA Female	EAR99	PE9830	\$510.68	69
										N Female	EAR99	PE9876	\$211.09	70
CPR-137G	N Female	EAR99	PE9838					\$298.75	71					
	N Female	EAR99	PE9821					\$689.78	72					
CMR-159	SMA Female	EAR99	PE9831					\$647.62	73					
	N Female	EAR99	PE9839					\$727.71	74					
WR-187	3.95 - 5.85		1.25:1	CPR-159G	SMA Female	EAR99	PEWCA1057	\$597.41	75					
					N Female	EAR99	PEWCA1058	\$538.38	76					
				CMR-187	N Female	EAR99	PEWCA1059	\$538.38	77					
					N Female	EAR99	PEWCA1056	\$632.16	78					
				Round Cover UG-407/U	N Female	EAR99	PE9822	\$451.99	79					
					SMA Female	EAR99	PE9832	\$784.77	80					
WR-229	3.3 - 4.9		1.3:1	CPR-187G	N Female	EAR99	PE9840	\$830.83	81					
					N Female	EAR99	PE9823	\$610.70	82					
				CMR-229	SMA Female	EAR99	PE9833	\$648.80	83					
					N Female	EAR99	PE9877	\$866.43	84					
				CPR-229G	SMA Female	EAR99	PE9834	\$1,301.09	85					
					N Female	EAR99	PE9824	\$800.47	86					
WR-284	2.6 - 3.95		1.25:1	CMR-284	N Female	EAR99	PE9842	\$459.15	87					
					N Female	EAR99	PE9842	\$459.15	87					
WR-340	2.2 - 3.3	0.12	1.25:1	CPR-284G	N Female	EAR99	PE9842	\$459.15	87					
					N Female	EAR99	PE9842	\$459.15	87					
WR-430	1.7 - 2.6		1.3:1	CPR-340F	N Female	EAR99	PE9882	\$1,016.56	88					
					N Female	EAR99	PE9882	\$1,016.56	88					
				CPR-430F	SMA Female	EAR99	PE9835	\$1,346.22	89					
					N Female	EAR99	PE9872	\$1,250.72	90					
				CPR-430G	N Female	EAR99	PE9843	\$1,455.50	91					
					N Female	EAR99	PE9843	\$1,455.50	91					

See Our Website For Current Pricing & Real-Time Stock Availability!

WAVEGUIDE TRANSITIONS

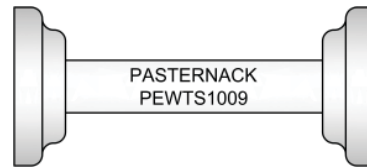
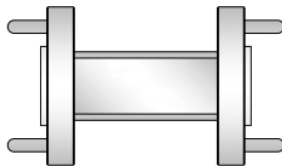

WG 1 Type	Flange 1 Type	WG 2 Type	Flange 2 Type	VSWR	ECCN	Model No	1	2-4	5-9	10+	ROW
WR-10	Round Cover UG-387/U-Mod	WR-12	Round Cover UG-387/U	1.6:1	EAR99	PE-W10TS12001A	\$1,205.04	\$1,156.84	\$1,108.64	\$1,060.44	92
		WR-15	Round Cover UG-385/U	1.45:1	EAR99	PE-W10TS15001	\$1,205.04	\$1,156.84	\$1,108.64	\$1,060.44	93
		WR-19	Round Cover UG-383/U-Mod	1.4:1	EAR99	PE-W10TS19001	\$1,311.36	\$1,258.91	\$1,206.45	\$1,154.00	94
WR-12	Round Cover UG-387/U	WR-15	Round Cover UG-385/U	1.2:1	EAR99	PE-W12TS15001	\$1,253.24	\$1,203.11	\$1,152.98	\$1,102.85	95
WR-15	Round Cover UG-385/U	WR-19	Round Cover UG-383/U-Mod	1.1:1	EAR99	PE-W15TS19001	\$1,253.24	\$1,203.11	\$1,152.98	\$1,102.85	96
		WR-22	Round Cover UG-383/U	1.15:1	EAR99	PE-W15TS22001	\$1,311.36	\$1,258.91	\$1,206.45	\$1,154.00	97
WR-19	Round Cover UG-383/U-Mod	WR-22	Round Cover UG-383/U	1.5:1	EAR99	PE-W19TS22001	\$1,205.04	\$1,156.84	\$1,108.64	\$1,060.44	98
		WR-28	Square Cover UG-599/U	1.35:1	EAR99	PE-W19TS28001	\$1,253.24	\$1,203.11	\$1,152.98	\$1,102.85	99
WR-22	Round Cover UG-383/U	WR-28	Square Cover UG-599/U	1.35:1	EAR99	PE-W22TS28001	\$1,253.24	\$1,203.11	\$1,152.98	\$1,102.85	1
		WR-42	Square Cover UG-595/U	1.35:1	EAR99	PE-W22TS42001	\$1,205.04	\$1,156.84	\$1,108.64	\$1,060.44	2
WR-28	Square Cover UG-599/U	WR-42	Square Cover UG-595/U	1.2:1	EAR99	PE-W28TS42001	\$1,205.04	\$1,156.84	\$1,108.64	\$1,060.44	3
		WR-51	UBR-180/U-Mod	1.38:1	EAR99	PE-W28TS51001	\$1,311.36	\$1,258.91	\$1,206.45	\$1,154.00	4

Waveguides



Free Shipping Available via UPS Ground to USA & Canada



Technical Support (866) 727-8376



Same-Day Shipping, Even Custom Cable Assemblies

WAVEGUIDE TRANSITIONS

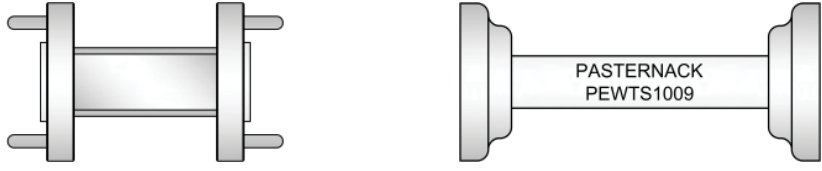

WG 1 Type	Flange 1 Type	WG 2 Type	Flange 2 Type	VSWR	ECCN	Model No	1	2-4	5-9	10+	ROW
WR-34	Square Cover UG-1530/U	WR-28	Square Cover UG-599/U	1.08:1	EAR99	PEWTS1010	\$767.54	\$736.84	\$706.14	\$675.44	5
WR-42	Square Cover UG-595/U	WR-34	Square Cover UG-1530/U	1.08:1	EAR99	PEWTS1009	\$744.30	\$714.53	\$684.76	\$654.98	6
WR-51	Square Cover	WR-42	Square Cover UG-595/U	1.08:1	EAR99	PEWTS1008	\$744.30	\$714.53	\$684.76	\$654.98	7
WR-62	Square Cover UG-1665/U	WR-51	Square Cover	1.08:1	EAR99	PEWTS1007	\$805.03	\$772.83	\$740.63	\$708.43	8
WR-75	Square Cover	WR-62	Square Cover UG-1665/U	1.08:1	EAR99	PEWTS1006	\$805.03	\$772.83	\$740.63	\$708.43	9
WR-90	Square Cover UG-39/U	WR-75	Square Cover	1.08:1	EAR99	PEWTS1004	\$815.75	\$783.12	\$750.49	\$717.86	10
	CPR-90G	WR-75		1.08:1	EAR99	PEWTS1005	\$842.18	\$808.49	\$774.81	\$741.12	11
WR-112	Square Cover UG-51/U	WR-90	Square Cover UG-39/U	1.08:1	EAR99	PEWTS1002	\$863.37	\$828.84	\$794.30	\$759.77	12
	CPR-112G	WR-90	CPR-90G	1.08:1	EAR99	PEWTS1003	\$851.46	\$817.40	\$783.34	\$749.28	13
WR-137	Round Cover UG-344/U	WR-112	Square Cover UG-51/U	1.08:1	EAR99	PEWTS1000	\$922.91	\$885.99	\$849.08	\$812.16	14
	CPR-137G	WR-112	CPR-112G	1.08:1	EAR99	PEWTS1001	\$928.88	\$891.72	\$854.57	\$817.41	15

WAVEGUIDE TWISTS

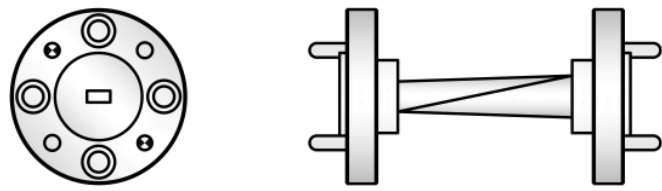

WG Type	RF Freq. (GHz.)	Max VSWR	WG Offset Angle (Deg)	Length (in)	Flange Type	ECCN	Model No	1	2-4	5-9	10+	ROW
WR-10	75 - 110	1.1:1	45 Left-hand	1	Round Cover UG-387/U-Mod	EAR99	PE-W10TW1002	\$418.22	\$401.49	\$384.76	\$368.03	16
			45 Right-hand		Round Cover UG-387/U-Mod	EAR99	PE-W10TW1003	\$418.22	\$401.49	\$384.76	\$368.03	17
		1.43:1	90		Round Cover UG-387/U-Mod	EAR99	PE-W10TW1001	\$394.41	\$378.63	\$362.86	\$347.08	18
WR-12	60 - 90	1.16:1	45 Left-hand	1	Round Cover UG-387/U	EAR99	PE-W12TW1002	\$418.22	\$401.49	\$384.76	\$368.03	19
			45 Right-hand		Round Cover UG-387/U	EAR99	PE-W12TW1003	\$418.22	\$401.49	\$384.76	\$368.03	20
		1.12:1	90		Round Cover UG-387/U	EAR99	PE-W12TW1001	\$467.86	\$449.15	\$430.43	\$411.72	21
WR-15	50 - 75	1.11:1	45 Left-hand	1	Round Cover UG-385/U	EAR99	PE-W15TW1002	\$418.22	\$401.49	\$384.76	\$368.03	22
			45 Right-hand		Round Cover UG-385/U	EAR99	PE-W15TW1003	\$418.22	\$401.49	\$384.76	\$368.03	23
		90	Round Cover UG-385/U		EAR99	PE-W15TW1001	\$394.41	\$378.63	\$362.86	\$347.08	24	
WR-19	40 - 60	1.25:1	45 Left-hand	2	Round Cover UG-383/U-Mod	EAR99	PE-W19TW1002	\$418.22	\$401.49	\$384.76	\$368.03	25
			45 Right-hand		Round Cover UG-383/U-Mod	EAR99	PE-W19TW1003	\$418.22	\$401.49	\$384.76	\$368.03	26
		1.22:1	90		Round Cover UG-383/U-Mod	EAR99	PE-W19TW1001	\$368.60	\$353.86	\$339.11	\$324.37	27
WR-22	33 - 50	1.02:1	45 Left-hand	2	Round Cover UG-383/U	EAR99	PE-W22TW1002	\$418.22	\$401.49	\$384.76	\$368.03	28
			45 Right-hand		Round Cover UG-383/U	EAR99	PE-W22TW1003	\$418.22	\$401.49	\$384.76	\$368.03	29
			90		Round Cover UG-383/U	EAR99	PE-W22TW1001	\$368.60	\$353.86	\$339.11	\$324.37	30
WR-28	26.5 - 40	1.09:1	45 Left-hand	2	Square Cover UG-599/U	EAR99	PE-W28TW1002	\$447.50	\$429.60	\$411.70	\$393.80	31
			45 Right-hand		Square Cover UG-599/U	EAR99	PE-W28TW1003	\$447.50	\$429.60	\$411.70	\$393.80	32
		1.07:1	90		Square Cover UG-599/U	EAR99	PE-W28TW1001	\$368.60	\$353.86	\$339.11	\$324.37	33
WR-42	18 - 26.5	1.25:1	45 Left-hand	3	Square Cover UG-595/U	EAR99	PE-W42TW1002	\$435.95	\$418.51	\$401.07	\$383.64	34
			45 Right-hand		Square Cover UG-595/U	EAR99	PE-W42TW1003	\$435.95	\$418.51	\$401.07	\$383.64	35
		1.07:1	90		Square Cover UG-595/U	EAR99	PE-W42TW1001	\$413.38	\$396.84	\$380.31	\$363.77	36

WAVEGUIDES VARIABLE ATTENUATORS

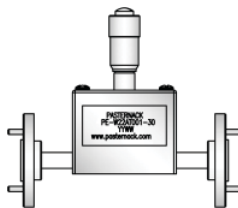

Waveguide Type	RF Frequency (GHz.)	Flange Type	IL (dB)	Max Atten. (dB)	ECCN	Model No	1	2-4	5-9	10+	ROW
WR-10	75 - 110	Round Cover UG-387/U-Mod	1	30	EAR99	PE-W10AT001-30	\$1,859.97	\$1,785.57	\$1,711.17	\$1,636.77	37
WR-12	60 - 90	Round Cover UG-387/U	0.9		EAR99	PE-W12AT001-30	\$1,850.86	\$1,776.83	\$1,702.79	\$1,628.76	38
WR-15	50 - 75	Round Cover UG-385/U	0.8		EAR99	PE-W15AT001-30	\$1,850.86	\$1,776.83	\$1,702.79	\$1,628.76	39
WR-19	40 - 60	Round Cover UG-383/U-Mod	0.6		EAR99	PE-W19AT001-30	\$1,806.83	\$1,734.56	\$1,662.28	\$1,590.01	40
WR-22	33 - 50	Round Cover UG-383/U	0.5		EAR99	PE-W22AT001-30	\$1,771.40	\$1,700.54	\$1,629.69	\$1,558.83	41

WAVEGUIDE ACCESSORIES

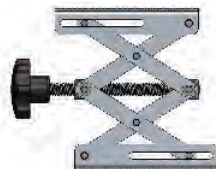

Model No	Description	1	2-4	5-9	10+	ROW
PEWVK1014	WR-28 Waveguide Electrically Conductive Gasket kit Square Cover, Choke Flange	\$102.02	\$97.94	\$93.86	\$89.78	42
PEWVK1000	WR-28 Waveguide Gasket kit Square Cover, Choke Flange, Non-Conductive	\$42.46	\$40.76	\$39.06	\$37.36	43
PEWVK1015	WR-42, WR-34 Waveguide Electrically Conductive Gasket kit Square Cover, Choke Flange	\$117.58	\$112.88	\$108.17	\$103.47	44
PEWVK1001	WR-42, WR-34 Waveguide Gasket kit Square Cover, Choke Flange, Non-Conductive	\$42.70	\$40.99	\$39.28	\$37.58	45
PEWVK1016	WR-51 Waveguide Electrically Conductive Gasket kit Square Cover, Choke Flange	\$134.36	\$128.99	\$123.61	\$118.24	46
PEWVK1002	WR-51 Waveguide Gasket kit Square Cover, Choke Flange, Non-Conductive	\$43.66	\$41.91	\$40.17	\$38.42	47
PEWVK1017	WR-62 Waveguide Electrically Conductive Gasket kit Square Cover, Choke Flange	\$196.36	\$188.51	\$180.65	\$172.80	48
PEWVK1003	WR-62 Waveguide Gasket kit Square Cover, Choke Flange, Non-Conductive	\$46.94	\$45.06	\$43.18	\$41.31	49
PEWVK1018	WR-75 Waveguide Electrically Conductive Gasket kit Square Cover, Choke Flange	\$117.33	\$112.64	\$107.94	\$103.25	50
PEWVK1004	WR-75 Waveguide Gasket kit Square Cover, Choke Flange, Non-Conductive	\$46.94	\$45.06	\$43.18	\$41.31	51
PEWVK1019	WR-90 Waveguide Electrically Conductive Gasket kit Square Cover, Choke Flange	\$164.51	\$157.93	\$151.35	\$144.77	52
PEWVK1021	WR-90 Waveguide Electrically Conductive Gasket kit, CPR Flat Flange	\$125.85	\$120.82	\$115.78	\$110.75	53
PEWVK1020	WR-90 Waveguide Electrically Conductive Gasket kit, CPR Grooved Flange	\$145.30	\$139.49	\$133.68	\$127.86	54
PEWVK1005	WR-90 Waveguide Gasket kit Square Cover, Choke Flange, Non-Conductive	\$50.48	\$48.46	\$46.44	\$44.42	55
PEWVK1007	WR-90 Waveguide Gasket kit, CPR90 Flat Flange, Non-Conductive	\$56.90	\$54.62	\$52.35	\$50.07	56
PEWVK1006	WR-90 Waveguide Gasket kit, CPR90 Grooved Flange, Non-Conductive	\$56.90	\$54.62	\$52.35	\$50.07	57
PEWVK1022	WR-112 Waveguide Electrically Conductive Gasket kit Square Cover, Choke Flange	\$142.86	\$137.15	\$131.43	\$125.72	58
PEWVK1024	WR-112 Waveguide Electrically Conductive Gasket kit, CPR Flat Flange	\$128.87	\$123.72	\$118.56	\$113.41	59
PEWVK1023	WR-112 Waveguide Electrically Conductive Gasket kit, CPR Grooved Flange	\$178.96	\$171.80	\$164.64	\$157.48	60
PEWVK1008	WR-112 Waveguide Gasket kit Square Cover, Choke Flange, Non-Conductive	\$50.48	\$48.46	\$46.44	\$44.42	61
PEWVK1010	WR-112 Waveguide Gasket kit, CPR112 Flat Flange, Non-Conductive	\$58.61	\$56.27	\$53.92	\$51.58	62
PEWVK1009	WR-112 Waveguide Gasket kit, CPR112 Grooved Flange, Non-Conductive	\$58.61	\$56.27	\$53.92	\$51.58	63
PEWVK1026	WR-137 Waveguide Electrically Conductive Gasket kit, CPR Grooved Flange	\$168.02	\$161.30	\$154.58	\$147.86	64
PEWVK1027	WR-137 Waveguide Electrically Conductive Gasket kit, CPR Grooved Flange	\$142.86	\$137.15	\$131.43	\$125.72	65
PEWVK1025	WR-137 Waveguide Electrically Conductive Gasket kit, Round Cover, Choke Flange	\$294.09	\$282.33	\$270.56	\$258.80	66
PEWVK1011	WR-137 Waveguide Gasket kit Round Cover, Choke Flange, Non-Conductive	\$54.61	\$52.43	\$50.24	\$48.06	67
PEWVK1013	WR-137 Waveguide Gasket kit, CPR137 Flat Flange, Non-Conductive	\$60.44	\$58.02	\$55.60	\$53.19	68
PEWVK1012	WR-137 Waveguide Gasket kit, CPR137 Grooved Flange, Non-Conductive	\$60.44	\$58.02	\$55.60	\$53.19	69
PEWVHW1001	Waveguide Table Jack, Large	\$329.98	\$316.78	\$303.58	\$290.38	70
PEWVHW1000	Waveguide Table Jack, Medium	\$277.88	\$266.76	\$255.65	\$244.53	71
PEWVHW9000	4-40 with 3/32 inch Hex, Stainless Steel Waveguide Flange Screw	\$4.29	\$4.12	\$3.95	\$3.78	72

See Our Website For Current Pricing & Real-Time Stock Availability!

Waveguides



Free Shipping Available via UPS Ground to USA & Canada



Technical Support (866) 727-8376



Same-Day Shipping, Even Custom Cable Assemblies

PASTERNAK ENTERPRISES -- REACH PRODUCT COMPLIANCE PROGRAM

What is REACH Compliance?

Regulation (EC) No. 1907/2006 of the European Parliament and of the Council of 18 December 2006 is commonly referred to as REACH (Registration, Evaluation, Authorization, and Restriction of Chemicals). The REACH regulation became effective on June 1, 2007 to streamline and improve the former legislative framework for chemicals available in the European Union (EU) and European Economic Area (EEA) countries.

The objective of REACH is to improve protection of human health and the protection of the environment from the exposure to chemicals. REACH compliance is mandatory for products manufactured in, or imported into the European Union (EU).

As outlined by the REACH regulation, any organization manufacturing, importing, using or placing a substance, mixture, article or product on the EU market will be responsible for ensuring that the component substances are in compliance with REACH regulations.

Determining REACH Compliance of Pasternack Products:

Pasternack Enterprises does not currently either manufacture or import any chemical substances into the EU on their own or in articles (products) in quantities of 1 ton or more per year. In addition, products imported by Pasternack Enterprises' customers do not contain chemical substances intended to be released during the normal and reasonably foreseeable conditions of the product's use as defined by the REACH regulation and existing guidance.

However, under REACH, there is an obligation to ensure that articles do not contain <0.1% by weight of Substances of Very High Concern (SVHCs). SVHCs are substances that may cause cancer or other serious health or environmental effects and thus face restriction or outright bans, and are listed in a regularly-updated 'Candidate list'. The current Candidate list can be downloaded from the European Chemicals Agency (ECHA) website:

http://echa.europa.eu/chem_data/authorisation_process/candidate_list_table_en.asp

For each part that has been found to comply with the REACH SVHC reporting requirements, we show an indication of compliance adjacent to the part number using this symbol:



All products displaying this symbol on our website are assured to contain no SVHCs as defined by the Candidate List displayed on the Pasternack REACH certificate. When you locate the product you need on our website, please click on the "Product ID or Part Number". You will see the "REACH symbol" for the specific part. Click on this symbol to view the Certificate of REACH Compliance (printable if needed) for the specific product as well as the applicable ECHA SVHC Candidate list Date.

Pasternack Enterprises - REACH Product Compliance Program:

At Pasternack Enterprises, we recognize our responsibility as a worldwide supplier of RF, Microwave and Fiber Optic Products subject to the REACH regulations. We have completed a comprehensive effort internally and with our supply chain to determine the REACH compliance of our products. You will find our Reach Symbol adjacent to all products on our website that have been determined by Pasternack and our supply chain to contain less than 0.1% by weight of the REACH substances. You will also see the applicable ECHA SVHC Candidate List Date. "Please refer to our website at www.Pasternack.com.

The Pasternack Enterprises REACH Product Compliance Program is implemented in accordance with Regulation No. 1907/2006 of the European Parliament and the Council of 18 December 2006. Pasternack has implemented a REACH compliance program to address this legislation. Pasternack Enterprises does not currently either manufacture or import any chemical substances into the EU on their own or in articles (products) in quantities of 1 ton or more per year. In addition, products imported by Pasternack Enterprises' customers do not contain chemical substances intended to be released during the normal and reasonably foreseeable conditions of the product's use as defined by the REACH regulation and existing guidance. Thus, Pasternack Enterprises does not currently have a direct REACH obligation to pre-register substances. Pasternack's REACH Product Compliance is determined by a certification from our supply chain. A Pasternack product is deemed to be REACH compliant when it does not contain Substances of Very High Concern (SVHCs) beyond the specified concentration limits of less than 0.1% by weight as outlined in REACH 1907/2006/EU regulation.

Need More Information?

If you have questions regarding REACH Product Certification on Pasternack's products, please contact the Pasternack REACH Compliance Team via email at REACH@Pasternack.com or by calling Toll-Free within North America at 1-866-PASTERNAK (1-866-727-8376). International customers, please call +1-949-261-1920.



Free Shipping Available
via UPS Ground
to USA & Canada



Technical
Support
(866) 727-8376



Same-Day Shipping,
Even Custom
Cable Assemblies

PASTERNAK ENTERPRISES ROHS COMPLIANCE PROGRAM

Lead-free solder is now available for all cable assemblies upon request or online at www.Pasternack.com.

Our Commitment

At Pasternack, we recognize our responsibility as an international supplier of RF, Microwave and Millimeter wave electronics products to maintain a comprehensive RoHS compliance program. We are fully committed to offering RoHS compliance on the majority of our products and posting accurate RoHS compliance status for all of our products. We have posted this data on our website so that it can be easily found for each part number within our on-line catalogue.

What is RoHS Compliance?

The European Union set forth the RoHS (Restriction of Hazardous Substances) Directive to establish environmental guidelines and legislation to reduce the presence of six (6) materials deemed hazardous to the environment. To comply, products entering the EU must not have a homogeneous presence of these materials above the following levels by weight percentage

- Lead (Pb) < 0.1%
- Mercury (Hg) < 0.1%
- Cadmium (Cd) < 0.01%
- Hexavalent Chromium (CrVI) < 0.1%
- Polybrominated Biphenyls (PBB) < 0.1%
- Polybrominated Diphenyl Esters (PBDE) < 0.1%

Determining Pasternack RoHS Compliance

All products displaying this symbol on our website have been certified as RoHS Compliant. Click on the symbol to view the Certificate of RoHS Compliance for that product.



Lead Free Cable Assemblies

Many of Pasternack's cable assemblies are built with leaded solder. If so, the part will not be RoHS compliant and a certificate will not be found on the product page for that assembly. However, many of these assemblies can be brought into RoHS compliance through the use of Lead-Free solder. If the assembly you desire is not RoHS compliant, there may be a RoHS compliant version with a similar part number. If so, you will see an "LF" contained in the basic part number (example PE3067LF-24 is the lead free version of PE3067-24). Please note: the "LF" designation is used only when the base part number is not RoHS compliant. Many assemblies do not include "LF" and are compliant because they are only offered in a RoHS compliant configuration.

For More Information

Please direct any questions to Pasternack Enterprises Technical Support via email at TechSupport@Pasternack.com or by calling Toll-Free within North America at 1-866-PASTERNAK (866-727-8376). International customers, please use +1-949-261-1920.

MAILING LIST CHANGES

If you receive more than one RF Product Guide with the same name and address, please notify Pasternack and pass the RF Product Guide along to a friend. Also, if you do not require multiple copies to the same company address, contact a sales representative to verify and modify your mailing information. A forms-based communications method to add, delete or modify mailing information is available at www.pasternack.com. By clicking "Contact Us", and then clicking "Remove Name from Mailing List", you may complete the form to request a change to your mailing preferences. In addition, by clicking "RF Product Guide", and then clicking "Request a Printed RF Product Guide", you may add your contact information to our mailing list. Please note service opt-in and opt-out options located on the forms. Alternatively, you may mail, email, telephone or fax Pasternack your request.

PLACING YOUR ORDER

► **By Telephone: 866-PASTERNAK (866-727-8376)
US & Canada, or 949-261-1920**

Our friendly sales representatives are ready to serve you from 5:00am to 5:30pm Pacific Standard Time (PST), Monday through Friday. For the most efficient service, please have ready a list of quantities and part numbers and, if paying by credit card, your MasterCard, VISA, American Express or Discover card. Note: Calls may be recorded or monitored for quality and training purposes.

► **By Fax: 949-261-7451**

Our fax lines can be accessed 7 days a week, 24 hours a day. Orders received after 4:00pm PST will be promptly processed and shipped the next business day. Please include your daytime phone number and/or email address in case we have any questions about your order.

► **By Internet: www.Pasternack.com
or Email: sales@pasternack.com**

Order online 7 days a week, 24 hours a day using our online ordering system. Just search for the items you want and add them to your shopping cart. Internet orders entered after 4:00 pm PST will be promptly processed and shipped the next business day.

► **By Mail: Simply Mail Your Order To:
Pasternack Enterprises, Inc.
17802 Fitch
PO Box 16759
Irvine, CA 92623-6759 USA**

International customers, please see "International Orders" below for additional information.

Terms and Conditions of Sale:

The following from Pasternack's Binding Terms and Conditions of Sale are provided for your convenience. A complete documentation of the Binding Terms and Conditions of Sale may be found in the back of the RF Product Guide, or on Pasternack's website at <http://www.pasternack.com/t-terms-of-sale.aspx>. Any questions or clarifications may be answered by contacting Customer Service at (+1) 949-261-1920 or by any of the methods listed above.

No Minimum Order Requirement

Ground Freight is Free:

On UPS Ground orders, there is no charge for shipping for USA & Canada orders of \$100.00 or greater. Otherwise, shipping or freight charges and insurance will be paid by the customer. All sales are made FOB Point (as defined by the INCOTERMS 2000) in Irvine, CA USA. Shipping or freight charges from Pasternack's Irvine, CA factory are prepaid and added to the invoice or billed collect.

Same-Day Shipment:

Same-day shipment will apply to orders received Monday through Friday, prior to 4:00pm PST.

- All UPS air and surface options
- All FedEx air options (with an approved account number)
- Most other shipping options, including DHL (with an approved account number) and USPS

Counter-to-Counter Shipping:

For your urgent order requiring our fastest shipping method, we will place your order on the next available flight from Santa Ana-Orange County John Wayne International Airport (Airport code: SNA) to the destination you specify. Please call for details.

Payment Terms:

Pasternack offers a number of convenient payment methods:

For United States customers, we offer check, money order, MasterCard, VISA, American Express, Discover, and C.O.D. as well as open account credit to qualified institutions and businesses. Payment must be made in US Dollars.

For Canadian customers, we offer all of the above payment options except C.O.D.

For International customers, see **International Orders**.

Open Account Credit:

Net 30 Days terms are available to businesses, schools and agencies subject to credit approval. Approval can begin by submitting a completed Credit Application, which can be found online at:

www.Pasternack.com/t-CreditApplication.aspx

EFT/Wire Transfers:

Please contact us for details. We will inform you of the total amount which will include shipping charges and any applicable wire transfer fees. Orders will not be accepted until funds have been received in full.

WELLS FARGO BANK
420 Montgomery St.
San Francisco, CA 94104 USA
Account Number: 4270 0000 0000 0000 1
Routing Number: 121000248
SWIFT Number: WFBUS6S

International Orders:

In addition to the United States and its territories, Pasternack accepts international orders. All orders of international origin are exported from the US in accordance with the Export Administration Regulations. Diversion contrary to US Law is prohibited. Please see Pasternack's Binding Terms and Conditions of Sale for full details.

Pasternack has international distributors for the following countries:

Africa: Namibia, South Africa

Asia-Pacific: Australia, China PRC, India, Indonesia, Japan, Malaysia, New Zealand, Singapore, South Korea, Thailand

Europe: Austria, Belgium, Czech Republic, Denmark, Finland, France, Germany, Ireland, Italy, Kazakhstan, Luxembourg, Netherlands, Norway, Poland, Portugal, Russia, Slovakia, Spain, Sweden, Switzerland, Turkey, United Kingdom

Middle East: Israel

South America: Brazil

To access their complete contact information, please see our International Distributors section in this RF Product Guide. (inside back cover)

International Shipping Charges:

Shipping or freight charges and insurance will be paid by the customer. All sales are made FOB Point (as defined by the INCOTERMS 2000) in Irvine, CA USA. We ship orders by UPS, FedEx (with an approved account number), or DHL (with approved account number) with delivery in 2 to 3 days to most locations worldwide.

International Taxes and Duties:

Customer is responsible for duties and taxes.



Free Shipping Available
via UPS Ground
to USA & Canada



Technical
Support
(866) 727-8376



Same-Day Shipping,
Even Custom
Cable Assemblies

BINDING TERMS AND CONDITIONS OF SALE

The following are the terms and conditions ("Terms and Conditions") for the sale of products ("Products") by Pasternack Enterprises, Inc. ("Pasternack") to Pasternack's customers ("Customers"). Please read this agreement carefully. Any different or additional terms set forth in customer's purchase order or similar communication are objected to and shall not be binding on the company unless a separate agreement has been signed by an authorized officer of the company. By placing an order for products from the company, or by accepting delivery of the products described on the applicable packing slip, bill of lading and/or invoice received with the products, you agree to be bound by and accept these terms and conditions of sale.

1. ACCEPTANCE AND CANCELLATION OF ORDERS

All orders are subject to acceptance by Pasternack in writing by a duly authorized agent of Pasternack; any written acknowledgement of receipt of an order shall not, in and of itself, constitute such acceptance. Orders accepted and processed by Pasternack may not be cancelled by Customer except as covered by the Limited Warranty. All sales are final. Cable Assemblies and Non-Standard Products are also Non-Cancelable/Non-Refundable ("NC/NR"). Non-Standard Parts are defined as Products which are special orders, custom orders, orders for non-standard products, products not customarily in stock or orders for value-added products. In the event of cancellation or other withdrawal of an order for any reason and without limiting any other remedy which Pasternack may have as a result of such cancellation or other withdrawal, reasonable cancellation or restocking charges, which shall include all expenses then incurred and commitments made by Pasternack, shall be paid by Customer to Pasternack. Customer requests to reschedule are subject to acceptance by Pasternack in its sole discretion. Orders may not be rescheduled after the order has been submitted by Pasternack to the shipment carrier.

2. PRICES

Orders are billed at the prices (in US dollars) in effect at the time of shipment. Prices will be as specified by Pasternack and will be applicable for the period specified in Pasternack's quote. If no period is specified, quoted prices will be applicable for thirty (30) days. The website contains the most current pricing and is the price reference for orders. Pricing included in the catalog is for reference only and final pricing is determined by the published website price. Prices shown in the RF Product Guide (Catalog) and on the website are subject to change without notice. Prices are exclusive of taxes, impositions and other charges, including: sales, use, excise, value added and similar taxes or charges imposed by any government authority, international shipping charges, forwarding agent's and broker's fees, bank fees, consular fees, document fees and import duties.

3. TERMS OF PAYMENT

All payments must be in US Dollars, or will be converted to US Dollars using the available exchange rate at the time of purchase.

MasterCard, VISA, Discover, and American Express credit cards, purchase cards and major bank debit cards are accepted. Payment via net thirty (30) days is available to businesses, schools and agencies or as otherwise specified by Pasternack subject to credit approval.

For International Orders

MasterCard, VISA, and American Express credit cards are accepted. Payment via open credit account with Net thirty (30) days may be established for companies having three U.S. references accepted to Pasternack. Prepaid Wire Transfer: You can wire the funds to our bank. We will contact you with the total amount, which will include shipping charges and a \$40 wire transfer fee. Orders will not be accepted until funds have been received in full and the Purchase Order (PO) has been received. Customer is responsible for sales, use, excise, value added and similar taxes or charges imposed by any government authority, international shipping charges, forwarding agent's and broker's fees, bank fees, consular fees, document fees and import duties.

4. SALES TAX

California residents are required to remit sales tax. Pasternack does not remit sales tax to states other than California. Any sales tax due that is not collected by Pasternack is the responsibility of the customer.

5. TOLERANCES

All coaxial cable assemblies displayed in the Pasternack catalog and website have a standard cable length tolerance of $\pm 1.5\%$ or 3/8 inches (0.375"), whichever is greater. Cable Assemblies in excess of this tolerance factor are eligible for repair and/or replacement under the terms of the Pasternack Limited Warranty.

6. DELIVERY AND TITLE

Shipping or freight charges and insurance will be paid by the customer. All sales are made FCA Shipping Point (as defined by the INCOTERMS 2000) in Irvine, CA USA. Shipping or freight charges from Pasternack's Irvine, CA facility are prepaid and added to the invoice, or billed collect. Subject to Pasternack's right of stoppage in transit, delivery of the Products to the carrier will constitute delivery to Customer and title and risk of loss will pass to Customer. Pasternack will make reasonable efforts to initiate shipment and schedule delivery as close as possible to Customer's requested delivery date(s). Customer acknowledges that delivery dates provided by Pasternack are estimates only and that Pasternack will not be liable for failure to deliver on such dates. Selection of the carrier and delivery route will be made by Pasternack unless specifically designated by Customer. Pasternack reserves the right to make deliveries in installments. Delay in delivery of one installment will not entitle Customer to cancel any other installment(s). Delivery of any installment of Products within thirty (30) days after the date requested will constitute a

timely delivery. Delivery of a quantity that varies from the quantity specified shall not relieve Customer of the obligation to accept delivery and pay for the Products delivered.

7. PASTERNAK'S LIMITED WARRANTY

All products are covered by a LIMITED WARRANTY for a period of one (1) year from the date of shipment when purchased from Pasternack Enterprises, Inc. Customer must notify Pasternack within one (1) year from date of shipment of any defective product. An approved Return Material Authorization (RMA) number must first be obtained from Pasternack prior to the return of any merchandise to Pasternack for inspection under warranty. Shipping charges for all materials returned under this Limited Warranty are to be prepaid by the Customer. This warranty is limited to the original purchaser. Pasternack's liability arising out of any sale of products to Customer is expressly limited to either (1) Credit for the purchase price paid by Customer for such products (without interest), or (2) Repair and/or replacement of such products, found to be defective after inspection by Pasternack, and such remedies shall be exclusive and in lieu of all others. THIS WARRANTY IS IN LIEU OF ANY AND ALL OTHER WARRANTIES, WHETHER ORAL, WRITTEN, EXPRESSED, IMPLIED OR STATUTORY. ANY IMPLIED WARRANTIES OF MERCHANTABILITY, FITNESS FOR A PARTICULAR PURPOSE AND NON-INFRINGEMENT ARE HEREBY DISCLAIMED. Further, no warranty will apply if the Product has been subject to misuse, neglect, accident or modification, or has been soldered or altered in any way.

All returns must be shipped to: Pasternack Enterprises, Inc.
17802 Fitch
Irvine, CA 92614 USA

8. LIMITATION OF LIABILITIES

In no event shall Pasternack be liable for any special, incidental or consequential damages of any nature including, but not limited to, damages resulting from loss of profit or revenue, recall costs, claims for service interruptions or failure to supply downtime, testing, installations or removal costs, costs of substitute products, property damage, personal injury, death or legal expenses. Customer's recovery from Pasternack for any claim shall not exceed the purchase price paid by Customer for the goods, irrespective of the nature of the claim, whether in warrant, contract or otherwise. CUSTOMER SHALL INDEMNIFY, DEFEND AND HOLD PASTERNAK HARMLESS FROM ANY CLAIMS brought by any party regarding products supplied by Pasternack and incorporated into the customer's product.

9. STATEMENTS AND ADVICE

If statements or advice, technical or otherwise, are offered or given to Customer, such statements or advice will be deemed to be given as an accommodation to Customer and without charge and Pasternack shall have no responsibility or liability for the content or use of such statements or advice.

10. EXPORT CONTROL AND EMBARGOES

Products purchased or received under these Terms and Conditions are subject to export control and economic sanctions laws, restrictions, regulations and orders of the United States. Customer agrees to comply with all applicable export control laws, restrictions and regulations of the United States and shall not export, or transfer for the purpose of re-export, any product to any embargoed country or region, including but not limited to Cuba, the Crimean Region of Ukraine, Iran, North Korea, Sudan, and Syria, or to any denied, blocked, or designated person or entity as mentioned in any such United States or foreign law or regulation. Customer represents and warrants that it is not on the Denied Persons, Specially Designated Nationals or Debarred Persons List (as identified by the U.S. Treasury Office of Foreign Asset Control (OFAC) and by the U.S. Department of Commerce, Bureau of Industry and Security (BIS), or any other United States list of prohibited persons; is not owned or controlled by any person that is on one of those lists, or is otherwise prohibited by United States or other law from purchasing the products or services hereunder. Customer shall be solely responsible to obtain any license to export, re-export or import as may be required. Customer also agrees that it will not use these products in connection with the proliferation of weapons of mass destruction, including missiles, nuclear, chemical or biological weapons.

11. GENERAL

The Terms and Conditions may not be modified or cancelled without Pasternack's written agreement. Accordingly, goods furnished and services rendered by Pasternack are sold only on the terms and conditions stated herein. The Terms and Conditions will be governed by and construed in accordance with the laws of the State of California and the applicable laws of the United States of America. If Customer chooses to access the Pasternack website from outside the United States, Customer does so on their own initiative and is responsible for compliance with all applicable local laws.

12. INTELLECTUAL PROPERTY

The drawings, text, product depictions, logos, content, product descriptions, and organization and taxonomy of Pasternack's RF Product Guide and website and of the described content within the RF Product Guide and website are proprietary to Pasternack and protected by intellectual property laws, including but not limited to United States Copyright law and United States Trademark law. Pasternack owns copyrights in these referenced works as well as the selection, arrangement, coordination and structure of the arranged content and works within their RF Product Guide and website. Use of the RF Product Guide/website does not give you any right to modify, reproduce, transmit, publish, publicly display, adapt, or create derivative works or in any way exploit any of the materials and content of Pasternack's RF Product Guide or website.

WARNING: Products in this catalog can expose you to chemicals including phthalates, which are known to the State of California to cause cancer and birth defects or other reproductive harm. For more information, go to www.P65Warnings.ca.gov. For specific products impacted, please visit www.pasternack.com.

PART NUMBER INDEX

Note: C/R stands for the Column and/or Row location of the specific product on a given page.

Model No.	Page	C/R	Model No.	Page	C/R	Model No.	Page	C/R	Model No.	Page	C/R	Model No.	Page	C/R	Model No.	Page	C/R
CST-400	Web		PE-T2005	201	21	PE-W15TS2001	237	97	PE-W61SF005-24	229	55	PE1611	72	15	PE15A3257	44	71
DBLU	Web		PE-T2006	201	25	PE-W15TW1001	238	24	PE-W61SF005-36	229	56	PE1612	72	16	PE15A3258	44	72
EZ-200-NMH-X	134	60	PE-T2007	202	36	PE-W15TW1002	238	22	PE-W61TF005-12	230	93	PE1613	72	17	PE15A3259	44	80
EZ-200-TM-X	153	29	PE-T2008	202	44	PE-W15TW1003	238	23	PE-W61TF005-24	230	94	PE1614	72	21	PE15A3260	44	85
EZ-240-4310M-X	119	77	PE-T2009	201	17	PE-W19AT001-30	239	40	PE-W61TF005-36	230	95	PE1615	72	18	PE15A3261	44	89
EZ-240-NMH-X	134	61	PE-T2010	201	33	PE-W19A15001	228	10	PE-W62B001	223	51	PE1616	72	19	PE15A3262	43	22
EZ-240-OMH-RA-X	138	76	PE-T2011	202	60	PE-W19B001	223	41	PE-W62B002	223	52	PE1617	72	23	PE15A3263	43	20
EZ-240-SMH-RA-X	141	65	PE-T2012	201	28	PE-W19C001	223	42	PE-W62B003	223	53	PE1618	72	25	PE15A3264	43	21
EZ-240-SM-X	141	65	PE-T2013	201	18	PE-W19CA001	235	78	PE-W62B004	223	54	PE1619	72	8	PE15A3265	43	31
EZ-240-TM-X	153	30	PE-T2014	201	22	PE-W19CA002	235	79	PE-W62S001-3	233	77	PE1620	72	9	PE15A3266	44	90
EZ-400-716M-X	120	95	PE-T2015	202	48	PE-W19CP001-10	225	13	PE-W62S001-6	233	78	PE1621	72	20	PE15A3267	44	65
EZ-400-BM-X	124	5	PE-T2016	202	37	PE-W19CP001-20	225	15	PE-W62S001-9	233	79	PE1622	72	27	PE15A3268	44	86
EZ-400-FM-75	157	43	PE-T2017	202	53	PE-W19CP003-10	225	14	PE-W62S001-12	233	76	PE11S1001	196	2	PE15A3269	44	60
EZ-400-NF-BH	136	41	PE-T2018	202	45	PE-W19CP003-20	225	16	PE-W62S002-6	233	74	PE11S1002	196	1	PE15A3270	44	74
EZ-400-NM-X	158	62	PE-T2019	202	46	PE-W19PS1001	232	33	PE-W62S002-12	233	75	PE11S1003	196	4	PE15A3271	44	73
EZ-400-NMC-2-D	134	54	PE-T2020	202	40	PE-W19S001-3	233	54	PE-W62S002-12	233	73	PE11S1004	196	3	PE15A3272	44	61
EZ-400-NMH-PL-X	134	62	PE-T2021	202	51	PE-W19S001-6	233	55	PE-W62S002-24	229	57	PE11S1005	196	5	PE15A3273	44	81
EZ-400-NMH-RA-X	135	90	PE-T2022	202	42	PE-W19S001-9	233	56	PE-W62S002-36	229	58	PE11S1006	196	6	PE15A3274	44	83
EZ-400-NMH-X	134	63	PE-T2023	202	57	PE-W19S001-12	233	53	PE-W62S003-6	229	59	PE11S1007	196	7	PE15A3275	44	93
EZ-400-TM-X	153	31	PE-T2024	202	43	PE-W19TR1001	234	21	PE-W62TF005-12	230	96	PE11S1008	196	8	PE15A3276	44	67
EZ-400-UM	155	99	PE-T2025	202	41	PE-W19TS2001	237	98	PE-W62TF005-24	230	97	PE12D1001	224	92	PE15A3290	44	68
EZ-600-6M-X	120	96	PE-W19AT001-30	228	7	PE-W19TS2001	237	98	PE-W62TF005-36	230	98	PE12D1002	224	98	PE15A3291	44	69
EZ-600-NF-X	135	15	PE-W19B001	222	35	PE-W19TS2002	238	27	PE-W62TF005-36	230	99	PE12D1003	224	90	PE15A3292	44	75
EZ-600-NMC-2-D	134	55	PE-W19B002	222	35	PE-W19TW1002	238	25	PE-W75B002	233	56	PE12D1004	224	89	PE15A3293	44	76
EZ-600-NMH-RA-X	135	91	PE-W19B002	222	36	PE-W19TW1003	238	26	PE-W75S001-3	233	81	PE12D1004	224	88	PE15A3294	44	79
EZ-600-NMH-X	134	64	PE-W19CA001	235	72	PE-W22AN001	230	41	PE-W75S001-6	233	82	PE12D1005	224	87	PE15A3295	44	77
EZ-600-TM-X	153	32	PE-W19CA002	235	73	PE-W22AT001-30	239	41	PE-W75S001-9	233	83	PE13U1000	224	98	PE15A3296	44	82
EZ-SW540-716MC	Web		PE-W19CP001-10	225	1	PE-W22A15001	228	11	PE-W75S001-12	233	80	PE13U1001	224	97	PE15A3300	44	15
EZ-SW540-NM-X	134	56	PE-W19CP001-20	225	3	PE-W22B001	223	43	PE-W75S001-24	233	80	PE13U1002	224	96	PE15A3301	44	70
ET-398	142	98	PE-W19CP003-10	225	29	PE-W22B002	223	44	PE-W75S001-36	233	81	PE13U1003	224	91	PE15A3302	44	73
LMR-100A-PVC	107	19	PE-W19CP003-20	225	4	PE-W22CA001	235	80	PE-W75S002-6	229	62	PE13U1004	224	94	PE15A3303	44	84
LMR-195	107	20	PE-W19PS1001	232	30	PE-W22CA002	235	81	PE-W75TF005-12	230	1	PE13U1005	224	93	PE15A3304	44	87
LMR-195-FR	107	21	PE-W19S001-3	233	43	PE-W22CP001-10	225	17	PE-W75TF005-24	230	1	PE15A1000	48	84	PE15A3305	44	88
LMR-195-LFL	107	22	PE-W19S001-6	233	44	PE-W22CP001-20	225	19	PE-W75TF005-36	230	2	PE15A1001	48	96	PE15A3306	44	91
LMR-200	107	23	PE-W19TR1001	234	18	PE-W22CP003-10	225	18	PE-W90B001	223	57	PE15A1002	48	3	PE15A3307	44	92
LMR-200-FR	107	24	PE-W19TS12001	Web		PE-W22CP003-20	225	20	PE-W90B002	223	58	PE15A1003	48	12	PE15A3308	44	96
LMR-240-LFL	107	16	PE-W19TS12002A	237	92	PE-W22PS1001	232	34	PE-W90B003	223	59	PE15A1003M	48	11	PE15A3309	44	99
LMR-240-S	107	8	PE-W19TS12003	237	93	PE-W22PS1002	232	35	PE-W90B004	223	60	PE15A1004	48	13	PE15A3310	44	98
LMR-240-DB	107	26	PE-W19TS19001	237	94	PE-W22S001-6	233	59	PE-W90S1005	233	85	PE15A1005	48	90	PE15A3311	44	97
LMR-240-LFL	107	27	PE-W19TS19002	238	18	PE-W22S001-9	233	60	PE-W90S1006	233	86	PE15A1006	48	2	PE15A3300	45	2
LMR-400	107	28	PE-W19TW1002	238	16	PE-W22S001-12	233	57	PE-W90S1007	233	87	PE15A1007	47	44	PE15A3501	45	7
LMR-400-75	107	1	PE-W19TW1003	238	17	PE-W22S005-6	229	42	PE-W90S1008	233	84	PE15A1008	47	67	PE15A3502	45	10
LMR-400-DB	107	29	PE-W19TB001	223	61	PE-W22S005-12	229	43	PE-W90S1009	233	89	PE15A1009	47	63	PE15A3503	44	51
LMR-400-LFL	107	10	PE-W19TB002	223	62	PE-W22S005-24	229	44	PE-W90S1010	233	90	PE15A1010	47	61	PE15A3504	44	52
LMR-400-FR	107	3	PE-W19TS12001	233	93	PE-W22TF005-6	230	81	PE-W90S1011	233	88	PE15A1011	47	55	PE15A3505	44	54
LMR-500	108	32	PE-W19TS12002	233	94	PE-W22TF005-12	230	82	PE-W90S1012	233	88	PE15A1012	47	58	PE15A3506	44	53
LMR-500-DB	108	33	PE-W19TS12003	233	95	PE-W22TF005-24	230	83	PE-W90S1013	233	88	PE15A1013	47	60	PE15A3507	44	55
LMR-600	108	34	PE-W19TS12004	233	92	PE-W22TR1001	234	22	PE-W90S1014	233	87	PE15A1014	47	73	PE15A3508	45	8
LMR-600-DB	108	35	PE-W19TS12005	233	92	PE-W22TS2001	237	1	PE-W90S1015	233	88	PE15A1015	47	77	PE15A3509	45	9
LMR-SW396	108	36	PE-W19TS2F005-24	230	73	PE-W22TS2002	237	2	PE-W90S1016	233	89	PE15A1016	47	78	PE15A3510	45	11
LMR-SW540	108	37	PE-W19TS2F005-36	230	74	PE-W22TR1002	237	3	PE-W90S1017	233	89	PE15A1017	47	80	PE15A3511	45	13
PE-020SR	108	84	PE-W19TS2F006-12	230	75	PE-W22TR1003	237	4	PE-W90S1018	233	90	PE15A1018	47	81	PE15A3512	45	14
PE-034SR	109	85	PE-W19TS2F006-24	230	76	PE-W22TR1004	238	29	PE-W90S1019	233	90	PE15A1019	47	82	PE15A3513	45	15
PE-047SR	109	86	PE-W19TS2F006-36	230	77	PE-W22TR1005	238	29	PE-W90S1020	233	90	PE15A1020	47	83	PE15A3514	45	16
PE-047SR-STRAIGHT	109	87	PE-W19TS2F007-12	230	72	PE-W26AT001	228	12	PE-W90S1021	233	90	PE15A1021	47	84	PE15A3515	45	17
PE-12ZFC	108	38	PE-W19TS2F007-24	230	73	PE-W26B001	223	46	PE-W90S1022	233	90	PE15A1022	47	85	PE15A3516	45	18
PE-12ZFH	108	39	PE-W19TS2F007-36	230	74	PE-W26B002	223	46	PE-W90S1023	233	90	PE15A1023	47	86	PE15A3517	45	19
PE-14ZFH	108	40	PE-W19TS2F008-12	230	9	PE-W26CA001	235	82	PE-W90S1024	233	90	PE15A1024	47	87	PE15A3518	45	20
PE-18SR	107	2	PE-W19TS2F008-24	230	11	PE-W26CA002	235	83	PE-W90S1025	233	90	PE15A1025	47	88	PE15A3519	45	21
PE-B159-BK	107	3	PE-W19TS2F008-36	230	11	PE-W26CP001-10	225	23	PE-W90S1026	233	90	PE15A1026	47	89	PE15A3520	45	22
PE-B159-GR	107	4	PE-W19AT001-30	229	8	PE-W26CP003-10	225	22	PE-W90S1027	233	90	PE15A1027	47	90	PE15A3521	45	23
PE-B159-RL	107	5	PE-W19AT001-30	229	8	PE-W26CP003-20	225	24	PE-W90S1028	233	90	PE15A1028	47	91	PE15A3522	45	24
PE-B159-RD	107	6	PE-W19B001	222	37	PE-W26CP003-30	225										

PART NUMBER INDEX

Note: C/R stands for the Column and/or Row location of the specific product on a given page.

Model No.	Page	C/R	Model No.	Page	C/R	Model No.	Page	C/R	Model No.	Page	C/R	Model No.	Page	C/R	Model No.	Page	C/R
PE236	203	15	PE7013	58	42	PE7335	63	96	PE7S2031	193	17	PE7S6148	Web		PE7S6272	192	89
PE238	205	38	PE7014	58	40	PE7336	63	1	PE7S2033	194	20	PE7S6149	Web		PE7S6273	192	90
PE239	205	70	PE7015	59	49	PE7337	63	5	PE7S2034	194	25	PE7S6150	185	11	PE7S6274	192	91
PE240	162	23	PE7016	59	50	PE7341	63	97	PE7S2035	191	44	PE7S6151	185	12	PE7S6275	192	92
PE241	203	31	PE7017	60	58	PE7343	63	8	PE7S2036	191	42	PE7S6152	185	13	PE7S6276	192	88
PE242	203	52	PE7018	61	69	PE7351	63	9	PE7S2037	193	94	PE7S6153	Web		PE7S6277	193	6
PE243	203	50	PE7019	62	90	PE7356	61	66	PE7S2038	192	64	PE7S6154	185	14	PE7S6278	193	9
PE246	204	69	PE7021	64	19	PE7357	61	71	PE7S2039	192	59	PE7S6155	185	15	PE7S6279	193	11
PE249	204	70	PE7021	64	19	PE7362	61	71	PE7S2040	192	60	PE7S6156	Web		PE7S6280	193	13
PE251	163	63	PE7022	65	28	PE7363	61	72	PE7S2041	191	50	PE7S6157	Web		PE7S6281	193	15
PE800	234	23	PE7024	56	12	PE7366	60	55	PE7S2042	192	61	PE7S6158	185	16	PE7S6282	193	16
PE801	234	29	PE7024/SP	56	13	PE7367	60	59	PE7S2043	191	41	PE7S6159	185	17	PE7S6283	193	10
PE802	234	34	PE7025	59	45	PE7368	60	60	PE7S2044	193	93	PE7S6160	185	18	PE7S6284	193	12
PE803	234	40	PE7026	64	17	PE7369	60	62	PE7S2045	193	18	PE7S6161	185	19	PE7S6285	193	14
PE804	234	47	PE7027	207	6	PE7370	60	61	PE7S2046	193	19	PE7S6162	185	20	PE7S6286	193	11
PE805	235	50	PE7028	207	11	PE7371	60	63	PE7S2047	Web		PE7S6163	Web		PE7S6287	194	27
PE806	235	55	PE7029	67	48	PE7372	61	65	PE7S2048	Web		PE7S6164	185	21	PE7S6288	194	29
PE807	235	61	PE7030	58	37	PE7373	60	64	PE7S3900	194	33	PE7S6165	Web		PE7S6289	194	30
PE808	235	64	PE7031	66	40	PE7375	61	74	PE7S3901	194	34	PE7S6166	Web		PE7S6290	194	31
PE809	234	24	PE7032	67	44	PE7378	61	75	PE7S3900	195	38	PE7S6167	Web		PE7S6291	194	32
PE810	234	30	PE7034	69	57	PE7379	59	53	PE7S5001	195	35	PE7S6168	Web		PE7S6292	194	28
PE811	234	35	PE7035	68	59	PE7387	60	54	PE7S5002	195	36	PE7S6169	Web	22	PE7S6293	195	36
PE812	234	41	PE7037	68	38	PE7388	64	20	PE7S5003	195	39	PE7S6170	Web		PE7S6294	195	37
PE813	Web		PE7040	59	44	PE7389	59	47	PE7S5004	195	40	PE7S6171	Web		PE7S6295	185	38
PE814	235	51	PE7042	61	77	PE7387	66	34	PE7S5005	195	37	PE7S6172	185	23	PE7S6296	185	39
PE815	235	56	PE7043	63	10	PE7388	62	86	PE7S5006	195	41	PE7S6173	Web		PE7S6297	185	40
PE816	235	62	PE7044	67	52	PE7389	62	87	PE7S5007	189	82	PE7S6174	Web		PE7S6298	185	41
PE817	235	65	PE7045	57	31	PE7390	58	39	PE7S5008	189	83	PE7S6175	Web		PE7S6299	185	42
PE818	234	27	PE7046	55	1	PE7391	58	41	PE7S5009	189	84	PE7S6176	Web		PE7S6300	185	43
PE819	234	32	PE7047	60	61	PE7392	61	63	PE7S5010	189	85	PE7S6177	Web		PE7S6301	185	44
PE820	234	38	PE7048	59	48	PE7393	61	67	PE7S5011	189	95	PE7S6178	Web		PE7S6302	Web	
PE821	234	43	PE7049	56	17	PE7394	62	88	PE7S5012	189	96	PE7S6179	185	24	PE7S6303	Web	
PE823	235	53	PE7050	67	49	PE7395	56	16	PE7S5013	185	9	PE7S6180	185	25	PE7S6304	Web	
PE824	235	59	PE7051	58	36	PE7396	67	51	PE7S5014	185	10	PE7S6181	Web		PE7S6305	185	48
PE825	Web		PE7052	59	43	PE7403	55	2	PE7S6000	187	2	PE7S6182	Web		PE7S6306	Web	
PE826	235	68	PE7053	59	51	PE7409	66	39	PE7S6001	Web		PE7S6183	Web		PE7S6307	Web	
PE827	Web		PE7054	67	73	PE7410	66	41	PE7S6002	Web		PE7S6184	Web		PE7S6308	Web	
PE828	234	33	PE7055	63	7	PE7411	66	43	PE7S6003	187	3	PE7S6185	Web		PE7S6309	Web	52
PE829	234	39	PE7057	61	50	PE7412	66	42	PE7S6004	187	36	PE7S6186	185	7	PE7S6310	Web	
PE830	234	44	PE7061	69	64	PE7417	66	35	PE7S6005	188	40	PE7S6187	Web		PE7S6311	186	53
PE831	234	49	PE7062	69	63	PE7418	66	36	PE7S6006	188	41	PE7S6188	Web		PE7S6312	Web	
PE832	235	54	PE7063	69	65	PE7419	66	38	PE7S6007	188	42	PE7S6189	Web		PE7S6313	Web	
PE833	235	60	PE7064	70	66	PE7420	66	37	PE7S6008	188	43	PE7S6190	Web		PE7S6314	Web	
PE834	235	65	PE7066	69	20	PE7421	66	21	PE7S6009	188	44	PE7S6191	Web	5	PE7S6315	Web	
PE835	235	69	PE7068	207	98	PE7422	70	67	PE7S6010	188	39	PE7S6192	Web		PE7S6316	Web	
PE836	234	48	PE7068	207	1	PE7423	67	46	PE7S6011	188	45	PE7S6193	185	6	PE7S6317	Web	
PE8R000	206	92	PE7069	207	2	PE70A1000	71	29	PE7S6072	187	99	PE7S6194	Web		PE7S6318	Web	
PE8R001	207	95	PE7070	207	7	PE70A1001	68	55	PE7S6073	187	1	PE7S6195	Web		PE7S6319	Web	
PE8R002	203	43	PE7071	207	5	PE70A1008	68	56	PE7S6074	188	62	PE7S6196	Web		PE7S6320	Web	
PE8R003	206	91	PE7072	207	3	PE70A1009	56	20	PE7S6075	188	65	PE7S6197	185	8	PE7S6321	186	76
PE8R004	206	90	PE7073	207	6	PE70A1010	56	21	PE7S6076	187	4	PE7S6198	184	3	PE7S6322	186	77
PE8R005	203	35	PE7074	207	10	PE70A1011	56	22	PE7S6077	Web		PE7S6199	Web	4	PE7S6323	186	78
PE8R006	203	44	PE7075	207	14	PE70A1012	56	23	PE7S6078	Web		PE7S6200	Web		PE7S6324	186	79
PE8R007	204	64	PE7076	207	16	PE70A1013	56	24	PE7S6079	Web		PE7S6201	Web		PE7S6325	185	30
PE8R008	204	65	PE7077	207	18	PE70A1014	56	25	PE7S6080	187	24	PE7S6202	Web		PE7S6327	185	31
PE8R009	204	71	PE7078	207	20	PE70A1015	56	26	PE7S6081	Web		PE7S6203	185	26	PE7S6328	185	32
PE8R010	204	68	PE7079	207	21	PE70A1016	56	27	PE7S6082	187	98	PE7S6204	Web		PE7S6329	187	37
PE8R011	204	75	PE7081	207	22	PE70A1017	71	27	PE7S6083	187	5	PE7S6205	185	27	PE7S6330	187	38
PE8R012	204	77	PE7082	207	23	PE70A1021	68	53	PE7S6084	Web	53	PE7S6206	Web		PE7S6331	187	39
PE8R013	204	86	PE7083	207	12	PE70A1022	69	59	PE7S6085	189	81	PE7S6207	Web		PE7S6332	189	79
PE8R014	204	84	PE7085	67	45	PE70A1023	69	61	PE7S6086	Web		PE7S6208	191	52	PE7S6333	189	90
PE8R015	204	91	PE7087	58	34	PE70A1024	69	58	PE7S6087	Web		PE7S6209	190	17	PE7S6334	189	77
PE8R016	204	87	PE7088	55	4	PE70A1025	69	60	PE7S6088	189	94	PE7S6210	191	48	PE7S6335	189	86
PE8R100	205	33	PE7089	55	3	PE70A1031	71	28	PE7S6089	Web		PE7S6211	192	76	PE7S6336	189	87
PE8R101	205	54	PE7090	96	15	PE70A2000	71	31	PE7S6090	186	83	PE7S6212	193	96	PE7S6337	189	88
PE8R102	206	65	PE7091	96	29	PE70A2001	71	32	PE7S6091	186	84	PE7S6213	194	21	PE7S6338	189	89
PE8R103	206	68	PE7092	97	33	PE70A2002	71	33	PE7S6092	187	80	PE7S6214	190	18	PE7S6339	189	93
PE8R104	206	83	PE7100	189	97	PE70A2003	71	34	PE7S6093	187	7	PE7S6215	191	49	PE7S6340	189	80
PE8R1005	206	84	PE7101	189	99	PE70A2900	71	30	PE7S6094	186	54	PE7S6216	192	77	PE7S6341	189	91
PE8R1006	206	85	PE7102	189	98	PE70A3900	71	24	PE7S6095	186	55	PE7S6217	193	97	PE7S6342	189	78
PE8R1013	204	62	PE7103	189	1	PE70A3901	71	25	PE7S6096	186	56	PE7S6218	194	22	PE7S6343	187	90
PE8R1014	203	32	PE7127	193	99	PE70A3902	71	26	PE7S6097	186	57	PE7S6219	192	69	PE7S6344	187	91
PE8R1020	205	19	PE7138	190	10	PE70A4900	70	8	PE7S6098	Web		PE7S6220	191	31	PE7S6345	186	85
PE8R1021	204	16	PE70A5000-CART	190	11	PE70A5000	71	9	PE7S6099	Web	58	PE7S6221	192	78	PE7S6346	187	92
PE8R1022	204	16	PE7140	190	11	PE70A5001	71	15	PE7S6100	Web		PE7S6222	192	85	PE7S6347	187	6
PE8R1023	204	17	PE7141	185	28	PE70A5002	71	16	PE7S6101	186	59	PE7S6223	193	7	PE7S6348	187	92
PE8R1024	205	37	PE7144	185	29	PE70A5003	70	1	PE7S6102	186	65	PE7S6224	194	23	PE7S6349	188	46
PE8R1025	205	36	PE7147	184	1	PE70A5004	70	10	PE7S6103	186	66	PE7S6225	191	32			

PART NUMBER INDEX

Note: C/R stands for the Column and/or Row location of the specific product on a given page.

Model No.	Page	C/R	Model No.	Page	C/R	Model No.	Page	C/R	Model No.	Page	C/R	Model No.	Page	C/R	Model No.	Page	C/R
PE71S6395	188	57	PE8035	177	40	PE8551	175	21	PE831R1011	105	3	PE9087	21	A2	PE9321		Web
PE71S6396	188	58	PE8036	177	41	PE8552	175	2	PE831R1012	105	7	PE9088	37	C5	PE9322		Web
PE71S6397	187	93	PE8037	177	42	PE8553	175	4	PE831R1013	105	80	PE9089	26	A6	PE9323		Web
PE71S6398	187	94	PE8038	177	43	PE8554	175	22	PE831R1014	105	60	PE9090	25	C5	PE9324		Web
PE71S6399	188	47	PE8040	170	91	PE8700	172	18	PE831R1015	105	82	PE9091	36	A6	PE9325		Web
PE71S6400	187	28	PE8044	Web		PE8701	172	28	PE831R1016	105	62	PE9093	20	A6	PE9326		Web
PE71S6401	188	69	PE8200	Web		PE8702	172	34	PE831R1017	105	89	PE9094	Web		PE9327		Web
PE71S6402	188	70	PE8201	Web		PE8703	172	30	PE831R1018	105	66	PE9095	Web		PE9328		Web
PE71S6403	187	97	PE8203	Web	75	PE8704	172	20	PE831R1019	105	94	PE9096	Web		PE9329		Web
PE71S6404	187	13	PE8210	169	64	PE8705	172	16	PE831R1020	105	69	PE9097	37	C6	PE9330		Web
PE71S6405	188	50	PE8211	169	65	PE8706	172	17	PE831R1021	105	97	PE9098	37	B6	PE9331		Web
PE71S6406	188	59	PE8212	169	66	PE8707	172	23	PE831R1022	105	72	PE9099	37	B2	PE9332		Web
PE71S6407	188	60	PE8213	169	66	PE8708	172	25	PE831R1023	105	1	PE9100	37	D1	PE9333		Web
PE71S6408	187	17	PE8214	168	59	PE8709	172	24	PE831R1024	105	4	PE9101	24	B3	PE9334		Web
PE71S6409	187	23	PE8215	168	60	PE8710	172	22	PE831R1025	105	8	PE9102	23	D6	PE9335		Web
PE71S6410	187	29	PE8216	168	49	PE8711	172	27	PE85N1001	178	66	PE9103	28	B3	PE9336		Web
PE71S8001	186	87	PE8217	168	50	PE8712	172	29	PE85N1002	178	70	PE9104	33	C5	PE9337		26
PE71S8002	186	88	PE8218	168	51	PE8713	172	30	PE85N1003	178	71	PE9105	31	C3	PE9338		D2
PE71S8003	232	39	PE8219	169	68	PE8714	172	32	PE85N1004	178	73	PE9106	20	C6	PE9339		25
PE71S8004	232	40	PE8220	169	69	PE8715	173	53	PE85N1005	178	74	PE9107	Web		PE9340		A1
PE71S8005	232	37	PE8221	169	70	PE8716	173	52	PE85N1006	177	47	PE9108	36	B2	PE9341		Web
PE71S8006	232	38	PE8222	168	43	PE8717	173	65	PE85N1007	177	46	PE9109	Web		PE9342		Web
PE73SP1000	183	42	PE8223	168	44	PE8718	173	54	PE85N1008	177	45	PE9110	Web		PE9343		A5
PE73SP1001	183	50	PE8224	168	45	PE8719	173	58	PE85N1009	177	44	PE9111	25	B6	PE9344		Web
PE73SP1002	183	51	PE8225	168	46	PE8720	173	63	PE85N1010	178	67	PE9112	27	C1	PE9345		Web
PE73SP1003	183	52	PE8226	168	47	PE8721	173	64	PE85N1011	178	68	PE9113	Web		PE9346		29
PE73SP1004	183	22	PE8227	168	48	PE8722	173	59	PE85N1012	178	69	PE9114	Web		PE9347		C3
PE73SP1005	183	23	PE8231	168	52	PE8723	173	57	PE85N1013	178	72	PE9115	Web		PE9348		A6
PE73SP1006	183	24	PE8232	168	53	PE8724	173	60	PE85N1014	178	62	PE9116	35	B5	PE9349		27
PE73SP1007	183	25	PE8233	168	54	PE8725	173	62	PE85N1015	178	63	PE9117	Web		PE9350		Web
PE73SP1008	183	26	PE8234	169	61	PE8726	173	61	PE85N1016	178	64	PE9118	Web		PE9351		35
PE73SP1010	183	45	PE8235	Web		PE8727	173	62	PE85N1017	178	56	PE9119	Web		PE9352		B1
PE73SP1011	183	58	PE8236	169	62	PE8728	174	70	PE85N1018	178	57	PE9120	Web		PE9353		D6
PE73SP1013	183	43	PE8237	168	40	PE8729	174	71	PE85N1019	178	58	PE9121	Web		PE9354		32
PE73SP1014	183	44	PE8238	168	41	PE8730	174	72	PE85N1020	178	59	PE9122	35	D5	PE9355		Web
PE73SP1015	183	40	PE8239	168	42	PE8731	174	73	PE85N1021	178	60	PE9123	Web		PE9356		Web
PE73SP1016	183	28	PE8240	168	43	PE8732	174	74	PE85N1022	178	61	PE9124	Web		PE9357		Web
PE73SP1017	183	41	PE8241	168	44	PE8733	174	75	PE86X1000	175	10	PE9125	26	B3	PE9358		D3
PE73SP1018	183	41	PE8242	168	57	PE8734	174	76	PE86X1001	175	12	PE9126	21	A6	PE9359		Web
PE73SP1019	183	39	PE8243	179	81	PE8735	174	77	PE86X1002	175	11	PE9127	25	B1	PE9360		Web
PE73SP1021	183	35	PE8244	179	82	PE8736	174	78	PE86X1003	175	7	PE9128	24	C2	PE9361		C2
PE73SP1022	183	37	PE8245	179	83	PE8737	Web		PE86X1004	175	9	PE9129	21	D6	PE9362		C6
PE73SP1023	183	57	PE8246	179	84	PE8738	174	79	PE86X1005	175	3	PE9130	25	A5	PE9363		21
PE73SP1024	183	34	PE8247	168	45	PE8739	173	31	PE86X1006	175	6	PE9131	26	D6	PE9364		C5
PE73SP1025	183	31	PE8250	169	67	PE8740	172	33	PE86X1007	175	5	PE9132	35	C6	PE9365		22
PE73SP1026	183	60	PE8251	169	63	PE8741	172	35	PE86X1008	175	8	PE9133	Web		PE9366		Web
PE73SP1028	183	55	PE8252	169	71	PE8742	172	36	PE86X1010	175	13	PE9136	35	D6	PE9368		A5
PE73SP1029	183	36	PE8253	179	87	PE8743	173	46	PE86X9000	175	14	PE9137	35	B6	PE9369		Web
PE73SP1030	183	30	PE8254	Web		PE8744	Web		PE86X9001	175	15	PE9138	Web		PE9370		A1
PE73SP1031	183	56	PE8255	179	86	PE8747	173	50	PE86X9002	175	16	PE9139	Web		PE9371		Web
PE73SP1032	183	61	PE8300	105	78	PE8748	173	51	PE86X9003	175	17	PE9140	Web		PE9372		Web
PE73SP1033	183	27	PE8301	105	79	PE80L1000	176	9	PE86X9004	175	18	PE9141	33	A2	PE9373		C4
PE73SP1034	183	33	PE8302	105	91	PE80L2000	176	13	PE86X9005	175	19	PE9142	33	D6	PE9374		B1
PE73SP1035	183	33	PE8303	105	96	PE80L2001	176	11	PE86X9006	175	20	PE9143	34	A1	PE9375		B5
PE73SP1036	183	54	PE8304	105	98	PE80L2002	176	15	PE86X9007	175	21	PE9144	31	B4	PE9376		A2
PE73SP1037	183	21	PE8305	105	2	PE80L2003	176	16	PE86X9008	175	22	PE9145	31	C4	PE9377		40
PE73SP1038	183	48	PE8306	105	6	PE80L2004	177	19	PE86X9009	175	23	PE9146	31	B1	PE9378		A4
PE73SP1039	183	47	PE8310	105	58	PE80L2005	176	17	PE86X9010	175	24	PE9147	Web		PE9379		Web
PE73SP1040	183	53	PE8311	105	64	PE80L2006	176	18	PE86X9011	175	25	PE9148	Web		PE9380		Web
PE73SP1041	183	53	PE8312	105	67	PE80L2007	177	20	PE86X9012	175	26	PE9149	Web		PE9381		Web
PE73SP1042	171	13	PE8313	105	70	PE80L2008	177	21	PE86X9013	175	27	PE9150	21	C1	PE9382		Web
PE73SP1043	171	14	PE8314	105	90	PE80L2009	177	12	PE86X9014	175	28	PE9151	21	B2	PE9383		Web
PE73SP1044	171	11	PE8315	105	92	PE80L3000	176	14	PE86X9015	175	29	PE9152	Web		PE9384		Web
PE73SP1045	171	12	PE8316	105	85	PE80L4000	176	14	PE86X9016	175	30	PE9153	Web		PE9385		A4
PE73SP1046	171	15	PE8317	105	86	PE80L4001	176	11	PE86X9017	175	31	PE9154	37	A3	PE9386		A2
PE73SP1047	183	48	PE8318	105	5	PE80L4002	176	9	PE86X9018	175	32	PE9155	37	C2	PE9387		B3
PE73SP1048	183	49	PE8319	105	52	PE80L4003	176	10	PE86X9019	175	33	PE9156	37	A2	PE9388		Web
PE73SP1049	183	29	PE8320	105	51	PE80L4004	176	12	PE86X9020	175	34	PE9157	37	B2	PE9389		Web
PE73SP1050	183	29	PE8321	105	73	PE80L4005	176	13	PE86X9021	175	35	PE9158	37	A3	PE9390		Web
PE7AF1000-9	55	9	PE8322	105	53	PE80L4006	176	14	PE86X9022	175	36	PE9159	37	A4	PE9391		Web
PE7AF1000-20	Web		PE8323	105	74	PE80L4007	176	15	PE86X9023	175	37	PE9160	37	B2	PE9392		C5
PE7AF1001-10	59	52	PE8324	105	54	PE80L4008	176	16	PE86X9024	175	38	PE9161	37	A3	PE9393		21
PE7AF1001-21	Web		PE8325	105	76	PE80L4009	176	17	PE86X9025	175	39	PE9162	37	D2	PE9394		B3
PE7AF1002-12	55	8	PE8326	105	77	PE80L4010	176	18	PE86X9026	175	40	PE9163	37	A4	PE9395		26
PE7AF1002-20	Web		PE8327	105	87	PE80L4011	176	19	PE86X9027	175	41	PE9164	37	A5	PE9396		A3
PE7AF1002-30	Web		PE8328	105	95	PE80L4012	176	20	PE86X9028	175	42	PE9165	37	A6	PE9397		B4
PE7SM1000	190	12	PE8329	105	96	PE80L4013	176	21	PE86X9029	175	43	PE9166	37	A7	PE9398		D3
PE7SM1000A	190	12	PE8330	105	98	PE80L4014	176	22	PE86X9030	175	44	PE9167	37	A8	PE9399		B5
PE8000-75	Web		PE8331	105	2	PE80L4015	176	23	PE86X9031	175	45	PE9168	37	A9			

PART NUMBER INDEX

Note: C/R stands for the Column and/or Row location of the specific product on a given page.

Model No.	Page	C/R	Model No.	Page	C/R	Model No.	Page	C/R	Model No.	Page	C/R	Model No.	Page	C/R	Model No.	Page	C/R
PE9349	23	A5	PE9472	30	C6	PE9595	23	B6	PE9721	Web		PE9959	Web		PE9859-20	220	32
PE9350	23	C6	PE9473	Web		PE9596	35	C3	PE9722	30	C4	PE9960	Web		PE9859NF-20	221	92
PE9351	Web		PE9474	Web		PE9597	Web		PE9723	30	D4	PE9961	Web		PE9859SF-20	221	95
PE9352	Web		PE9475	33	D2	PE9598	35	A4	PE9724	32	C3	PE9962	Web		PE9860-10	220	33
PE9353	Web		PE9476	31	B1	PE9599	Web		PE9725	32	D3	PE9963	Web		PE9860NF-10	221	96
PE9354	Web		PE9477	33	A3	PE9600	35	C2	PE9726	32	A2	PE9964	Web		PE9860SF-10	221	99
PE9355	Web		PE9478	31	C1	PE9601	35	B3	PE9727	30	A3	PE9965	Web		PE9860-15	220	34
PE9356	Web		PE9479	22	B2	PE9602	35	D2	PE9728	30	B3	PE9966	Web		PE9860SF-15	221	91
PE9357	Web		PE9480	Web		PE9603	35	A3	PE9729	32	B2	PE9967	Web		PE9860NF-15	221	97
PE9358	Web		PE9481	23	A6	PE9604	35	B4	PE9730	27	A2	PE9972	Web		PE9860-20	220	35
PE9359	24	A2	PE9482	27	B1	PE9605	Web		PE9731	27	B2	PE9801	236	33	PE9860SF-20	221	2
PE9360	26	B4	PE9483	Web		PE9606	Web		PE9732	35	B3	PE9802	236	41	PE9860NF-20	221	98
PE9361	38	C3	PE9484	20	D4	PE9607	Web		PE9733	35	D3	PE9803	236	6	PE9861-10	220	36
PE9362	38	D3	PE9485	29	B3	PE9608	39	C1	PE9734	Web		PE9804	236	34	PE9861NF-10	221	3
PE9363	38	A4	PE9486	33	B5	PE9609	Web		PE9735	Web		PE9805	236	39	PE9861SF-10	221	6
PE9364	Web		PE9487	Web		PE9610	Web		PE9736	39	C6	PE9806	236	7	PE9861-15	220	37
PE9365	Web		PE9488	31	D3	PE9611	Web		PE9737	39	B4	PE9809	236	3	PE9861NF-15	221	4
PE9366	38	B4	PE9489	Web		PE9612	Web		PE9738	39	D3	PE9810	236	35	PE9861SF-15	221	7
PE9367	Web		PE9490	26	C1	PE9613	39	C5	PE9739	39	A5	PE9811	236	40	PE9861-20	220	38
PE9368	39	C4	PE9491	25	D1	PE9614	Web		PE9740	39	B5	PE9812	236	97	PE9861NF-20	221	5
PE9369	39	C3	PE9492	26	B2	PE9615	39	D5	PE9741	38	D6	PE9813A	236	96	PE9861SF-20	221	8
PE9370	Web		PE9493	Web		PE9616	Web		PE9742	Web		PE9815	236	19	PE9862-15	220	39
PE9371	Web		PE9494	32	A2	PE9617	Web		PE9743	38	C6	PE9816	236	15	PE9862NF-15	221	9
PE9372	Web		PE9495	30	D5	PE9618	Web		PE9744	39	A1	PE9820	236	55	PE9862SF-15	221	11
PE9373	Web		PE9496	32	C5	PE9619	Web		PE9745	17	A5	PE9821	237	72	PE9862-20	220	40
PE9374	Web		PE9497	Web		PE9620	29	B4	PE9746	Web		PE9822	237	79	PE9862NF-20	221	10
PE9375	40	C3	PE9498	Web		PE9621	28	C6	PE9747	14	D4	PE9823	237	82	PE9862SF-20	221	12
PE9376	40	A3	PE9499	31	D2	PE9622	Web		PE9748	18	B1	PE9824	237	86	PE9863-10	220	43
PE9377	40	B3	PE9500	24	C4	PE9623	40	A1	PE9749	27	C5	PE9826	236	86	PE9863NF-10	221	13
PE9378	28	D1	PE9501	15	B5	PE9624	40	B1	PE9750	19	B6	PE9827	236	89	PE9863-15	220	46
PE9379	28	D2	PE9502	15	A5	PE9625	40	B3	PE9751	Web		PE9828	236	1	PE9863-20	220	44
PE9380	29	D1	PE9503	15	A5	PE9626	Web		PE9752	19	C6	PE9830	237	69	PE9863NF-20	221	14
PE9381	Web		PE9504	15	A3	PE9627	Web		PE9753	19	D5	PE9831	237	73	PE9863SF-20	221	16
PE9382	24	D4	PE9505	28	B1	PE9628	Web		PE9754	19	D6	PE9832	237	80	PE9864-10	220	45
PE9383	24	D2	PE9506	Web		PE9629	Web		PE9755	19	A6	PE9833	237	83	PE9864NF-10	221	17
PE9384	Web		PE9507	29	A2	PE9630	Web		PE9756	19	A5	PE9834	237	85	PE9864SF-10	222	20
PE9385	Web		PE9508	20	A4	PE9631	40	A2	PE9757	19	B5	PE9835	237	81	PE9864-15	222	48
PE9386	Web		PE9509	Web		PE9632	Web		PE9758	20	A4	PE9836	236	54	PE9864NF-15	222	18
PE9387	Web		PE9510	Web		PE9633	Web		PE9759	38	C5	PE9838	237	71	PE9864SF-15	222	21
PE9388	Web		PE9511	31	D5	PE9634	Web		PE9760	Web		PE9839	237	74	PE9864-20	220	47
PE9389	26	C3	PE9512	34	A3	PE9635	Web		PE9761	38	A6	PE9840	237	81	PE9864NF-20	222	19
PE9390	Web		PE9513	Web		PE9637	Web		PE9762	Web		PE9842	237	87	PE9864SF-20	222	22
PE9391	39	A2	PE9515	Web		PE9638	Web		PE9763	Web		PE9843	237	91	PE9865	236	58
PE9392	Web		PE9516	Web		PE9639	Web		PE9764	Web		PE9846	236	19	PE9866	236	59
PE9393	Web		PE9517	Web		PE9640	35	B1	PE9765	Web		PE9849	236	15	PE9867-10	220	18
PE9394	Web		PE9518	23	C1	PE9642	28	C2	PE9766	Web		PE9848	236	36	PE9868	236	26
PE9395	Web		PE9519	Web		PE9644	16	C1	PE9767	Web		PE9850-10	220	2	PE9869	236	38
PE9396	39	A4	PE9520	Web		PE9645	16	A1	PE9768	17	B2	PE98502F-10	220	48	PE9870	236	56
PE9397	39	D4	PE9521	38	A1	PE9646	16	A2	PE9769	Web		PE9850-15	220	3	PE9871	236	43
PE9398	22	D1	PE9522	23	A1	PE9647	16	B2	PE9770	Web		PE98502F-15	220	49	PE9872	237	90
PE9399	34	B5	PE9523	Web		PE9648	16	D2	PE9771	24	B5	PE9850-20	220	4	PE9873	236	32
PE9400	Web		PE9524	Web		PE9649	16	D6	PE9772	Web		PE98502F-20	220	5	PE9874	236	16
PE9401	31	C5	PE9525	Web		PE9650	18	D1	PE9773	Web		PE9851-10	220	5	PE9875	236	10
PE9402	34	C5	PE9526	Web		PE9651	17	D5	PE9774	28	A4	PE98512F-10	221	51	PE9876	237	70
PE9403	Web		PE9527	Web		PE9652	18	B2	PE9775	Web		PE98512F-15	221	52	PE9877	237	84
PE9404	Web		PE9528	Web		PE9653	30	C3	PE9776	Web		PE98512F-20	221	53	PE9878	236	95
PE9405	27	A5	PE9529	Web		PE9654	30	D3	PE9777	36	D2	PE9851A-15	220	6	PE9879	236	2
PE9406	21	D1	PE9530	Web		PE9655	32	C2	PE9778	Web		PE9851A-20	220	7	PE9881-20	220	6
PE9407	32	A6	PE9531	37	C4	PE9656	32	C1	PE9779	Web		PE9852A-15	220	8	PE9881-24	6, 222	6
PE9408	33	A6	PE9532	37	D4	PE9657	17	A6	PE9780	Web		PE9852-10	220	8	PE9881-34	6, 222	8
PE9409	Web		PE9533	30	A1	PE9658	17	B6	PE9781	Web		PE98522F-10	221	54	PE9881-42	6, 222	7
PE9410	Web		PE9534	29	C6	PE9659	18	C2	PE9782	17	B1	PE98522F-15	221	55	PE9881A-20	222	26
PE9411	Web		PE9535	24	C6	PE9660	16	D6	PE9783	37	D5	PE9852-20	220	10	PE9882	237	88
PE9412	Web		PE9536	Web		PE9661	16	A5	PE9786	33	C6	PE98522F-20	221	56	PE9883	236	31
PE9413	22	D2	PE9537	Web		PE9662	16	B6	PE9787	25	C3	PE9853-10	220	11	PE9884	236	57
PE9414	19	B1	PE9538	Web		PE9663	17	C1	PE9788	26	A5	PE9853SF-10	221	57	PE9887-11	222	23
PE9415	35	D1	PE9539	26	B3	PE9664	17	D1	PE9789	25	D3	PE9854-20	220	14	PE9888-11	222	24
PE9416	39	A3	PE9540	Web		PE9665	16	C5	PE9807	Web		PE9853-15	220	12	PE9889	236	37
PE9417	39	D2	PE9541	24	A3	PE9666	16	C3	PE9808	Web		PE9853SF-15	221	58	PE9890	236	42
PE9418	28	B2	PE9542	Web		PE9667	16	B3	PE9813	Web		PE9853-20	220	13	PE9891	37	A5
PE9419	22	A2	PE9543	Web		PE9668	16	D5	PE9814	Web		PE9853SF-20	221	59	PE91001	Web	
PE9420	20	D5	PE9544	Web		PE9669	28	A3	PE9816	Web		PE9854-10	220	15	PE91002	32	C6
PE9421	Web		PE9545	Web		PE9670	29	B5	PE9817	Web		PE9854NF-10	221	60	PE91003	30	A6
PE9422	Web		PE9546	28	C3	PE9671	28	D6	PE9818	Web		PE9854SF-10	220	23	PE91004	Web	
PE9424	Web		PE9547	Web		PE9672	15	D1	PE9829	Web		PE9854-15	220	16	PE91005	35	A2
PE9425	Web		PE9548	Web		PE9673	15	C3	PE9836	Web		PE9854NF-15	221	61	PE91006	Web	
PE9426	23	B5	PE9549	Web		PE9674	15	A2	PE9845	Web		PE9854SF-15	221	64	PE91007	32	D1
PE9427	23	A4	PE9550	25	A6	PE9675	15	D3	PE9849	Web		PE9854-20	220	17	PE91008	30	B4
PE9428	24	D1	PE9551	Web		PE9676	17	C4	PE9851-20	Web		PE9854NF-20	221	62	PE91009	32	A3
PE9429	24	C3	PE9552	Web		PE9677	17	D3	PE9852-15	Web		PE9854SF-20	221	65	PE91010	30	A4
PE9430	Web		PE9553	Web		PE9678	17	B4	PE9852-20	Web		PE9855-10	220	18	PE91011	32	B3
PE9431	31	C1	PE9554	25	D2	PE9679	Web		PE9853-10	Web		PE9855NF-10	221	68	PE91012	Web	
PE9432	31	D2	PE9555	Web		PE9680	Web		PE9882NF-10	Web		PE9855SF-10	221	69	PE91028	Web	
PE9433	31	B3	PE9556	19	C1	PE9681	Web		PE9862SF-10	Web		PE9855-15					

PART NUMBER INDEX

Note: C/R stands for the Column and/or Row location of the specific product on a given page.

Model No.	Page	C/R	Model No.	Page	C/R	Model No.	Page	C/R	Model No.	Page	C/R	Model No.	Page	C/R	Model No.	Page	C/R
PE91073	38	B1	PE91216	Web		PE91402	20	C2	PEWCA1045	236	49	PEWCT1031	227		PEWGS6004	228	18
PE91074	Web		PE91217	Web		PE91403	35	C1	PEWCA1046	237	67	PEWCT1032	227		PEWGS6005	228	19
PE91075	Web		PE91218	Web		PE91404	Web		PEWCA1047	237	68	PEWCT1033	227		PEWGS6006	228	20
PE91076	Web		PE91219	Web		PE91405	Web		PEWCA1048	237	59	PEWCT1034	227		PEWGS6007	228	21
PE91077	Web		PE91220	Web		PE91407	Web		PEWCA1049	237	60	PEWCT1035	227		PEWGS6008	228	22
PE91078	Web		PE91222	28	C4	PE91408	Web		PEWCA1050	237	63	PEWCT1036	227		PEWGS6009	228	23
PE91079	Web		PE91225	28	D4	PE91409	Web		PEWCA1051	237	64	PEWCT1037	227		PEWGS6010	228	24
PE91080	40	B2	PE91227	Web		PE91410	Web		PEWCA1056	237	78	PEWCT1038	227		PEWGS6011	228	25
PE91081	Web		PE91228	Web		PE91411	Web		PEWCA1057	237	75	PEWCT1039	227		PEWGS6012	228	26
PE91082	Web		PE91229	Web		PE91493	Web		PEWCA1058	237	76	PEWCT1040	227		PEWGS6013	228	27
PE91083	40	C2	PE91230	Web		PE91413	Web		PEWCA1059	237	77	PEWCT1041	227		PEWGS6014	228	28
PE91084	14	C3	PE91231	Web		PE91414	Web		PEWCP1005	225	25	PEWCT1042	227		PEWGS6015	228	29
PE91085	14	C2	PE91232	Web		PE91415	Web		PEWCP1006	225	26	PEWCT1043	227		PEWGS6016	229	30
PE91086	14	A3	PE91233	Web		PE91416	Web		PEWCP1007	225	27	PEWCT1044	227		PEWGS6017	229	31
PE91087	38	D1	PE91234	Web		PE91419	Web		PEWCP1008	225	32	PEWCT1045	227		PEWGS6018	229	32
PE91088	Web		PE91235	23	B3	PE91420	Web		PEWCP1009	225	33	PEWCT1046	227		PEWGS6019	229	33
PE91089	Web		PE91236	Web		PE91436	38	C5	PEWCP1010	225	34	PEWCT1047	227		PEWGS6020	229	34
PE91090	Web		PE91237	Web		PE91433	34	A6	PEWCP1011	225	35	PEWCT1048	227		PEWGS6021	229	35
PE91091	Web		PE91238	24	A4	PE91434	36	B5	PEWCP1012	225	36	PEWCT1049	227		PEWGS6022	229	36
PE91092	Web		PE91239	Web		PE91436	36	A5	PEWCP1013	225	37	PEWCT1050	227		PEWGS6023	229	37
PE91093	18	D4	PE91240	Web		PE91444	19	D3	PEWCP1014	225	38	PEWCT1051	227		PEWGS6024	229	38
PE91094	Web		PE91241	Web		PE91446	Web		PEWCP1015	225	39	PEWCT1052	227		PEWGS6025	229	39
PE91095	Web		PE91242	37	D3	PE91447	38	A3	PEWCP1016	225	40	PEWCT1053	227		PEWGS6026	229	40
PE91099	Web		PE91243	Web		PE91448	38	B6	PEWCP1017	225	41	PEWCT1054	227		PEWGS6027	229	41
PE91103	Web		PE91244	Web		PE91458	34	A6	PEWCP1018	225	42	PEWCT1055	227		PEWGS6028	229	42
PE91102	Web		PE91245	Web		PEM001	Web		PEWCP1019	225	45	PEWCT1056	227		PEWIR1001	Web	
PE91103	Web		PE91246	Web		PEM001-MIM	5	2	PEWCP1020	225	42	PEWCT1057	227		PEWIR1002	Web	
PE91104	21	B1	PE91247	Web		PEM002	Web		PEWCP1021	225	44	PEWCT1058	227		PEWIR1003	Web	
PE91105	40	D6	PE91248	Web		PEM002-MIM	5	3	PEWCP1022	225	46	PEWCT1059	227		PEWIR1004	Web	
PE91106	40	B6	PE91249	19	C3	PEM003-KIT	Web		PEWCP1023	225	47	PEWCT1060	227		PEWIR1005	Web	
PE91107	40	C6	PE91250	Web		PEM004	6	10	PEWCP1024	225	49	PEWCT1061	227		PEWIR1006	Web	
PE91108	14	A1	PE91251	Web		PEM005	6	11	PEWCP1025	225	51	PEWCT1062	227		PEWIR1007	Web	
PE91109	14	A2	PE91252	Web		PEM009-KIT	5	5	PEWCP1026	225	48	PEWCT1063	227		PEWIR1008	Web	
PE91110	15	B2	PE91253	Web		PEM009-KIT TRANSMIT	5	4	PEWCP1027	225	50	PEWCT1064	227		PEWIR1009	Web	
PE91111	15	B4	PE91254	Web		PEM009-KIT-TX	Web		PEWCP1028	225	52	PEWCT1065	227		PEWIR1010	Web	
PE91112	15	A4	PE91255	Web		PEM11000-KIT	Web		PEWCP1029	225	53	PEWCT1066	227		PEWMT1000	231	23
PE91113	16	C2	PE91256	Web		PEM11000-KIT	6	13	PEWCP1030	225	55	PEWCT1067	227		PEWMT1001	231	24
PE91114	23	C4	PE91257	Web		PEM11002-KIT	6	12	PEWCP1031	226	57	PEWCT1068	227		PEWMT1002	231	25
PE91115	14	D3	PE91258	29	D3	PETP1000	201	20	PEWCP1032	226	54	PEWCT1069	227		PEWMT1003	231	26
PE91116	Web		PE91259	29	B6	PETP1001	201	19	PEWCP1033	226	56	PEWCT1070	227		PEWMT1004	231	27
PE91117	19	A1	PE91260	30	B1	PETP1002	201	23	PEWCP1034	226	58	PEWCT1071	227		PEWMT1005	231	28
PE91118	14	B1	PE91261	30	D1	PETP1003	201	23	PEWCP1035	226	59	PEWCT1072	227		PEWMT1006	231	29
PE91119	14	D1	PE91262	30	B2	PETP1004	201	24	PEWCP1036	226	60	PEWCT1073	227		PEWSP1000	233	5
PE91120	15	D2	PE91263	30	C1	PETP1005	201	26	PEWCP1037	226	61	PEWCT1074	227		PEWSP1001	233	6
PE91121	Web		PE91264	29	D6	PETP1006	201	30	PEWCP1038	226	62	PEWCT1075	227		PEWSP1002	233	7
PE91122	15	C4	PE91265	Web		PETP1007	201	31	PEWCP1039	226	63	PEWCT1076	227		PEWSP1003	234	8
PE91123	15	D4	PE91266	Web		PETP1008	201	34	PEWCP1040	226	64	PEWCT1077	227		PEWSP1004	234	9
PE91124	Web		PE91267	Web		PETP1009	201	35	PEWCP1041	226	65	PEWCT1078	227		PEWSP1005	234	10
PE91125	Web		PE91268	Web		PETP1010	202	38	PEWCP1042	226	66	PEWCT1079	227		PEWSP1006	234	11
PE91126	16	D4	PE91269	Web		PETP1011	202	39	PEWCP1043	226	67	PEWCT1080	227		PEWSP1007	234	12
PE91127	17	A1	PE91270	29	D5	PETP1012	202	49	PEWCP1044	226	68	PEWCT1081	227		PEWSP1008	234	13
PE91128	Web		PE91290	29	D5	PETP1013	202	50	PEWCP1045	226	69	PEWCT1082	227		PEWSP1009	234	14
PE91129	33	A2	PE91291	18	A2	PETP1014	202	54	PEWCP1046	226	70	PEWCT1083	227		PEWSP1010	234	15
PE91134	26	A1	PE91292	17	C5	PETP1015	202	55	PEWCP1047	226	72	PEWCT1084	227		PEWSP1011	234	16
PE91135	15	C2	PE91293	17	C5	PETP1016	202	58	PEWCP1048	226	73	PEWCT1085	227		PEWSP1012	234	17
PE91136	15	C2	PE91294	Web		PETP1017	202	59	PEWCP1049	226	74	PEWCT1086	227		PEWTR1000	234	25
PE91137	14	A6	PE91295	16	B6	PEWAD5000	223	67	PEWCP1050	226	75	PEWCT1087	227		PEWTR1001	234	26
PE91138	14	C6	PE91296	Web		PEWAD5002	223	68	PEWCP1051	226	76	PEWCT1088	227		PEWTR1002	234	27
PE91139	15	A1	PE91297	Web		PEWAD5003	223	69	PEWCP1052	226	76	PEWCT1089	227		PEWTR1003	234	28
PE91140	Web		PE91298	16	D3	PEWAD5004	223	70	PEWCP1053	226	77	PEWCT1090	227		PEWTR1004	234	29
PE91141	24	C1	PE91299	33	C1	PEWAD5005	223	72	PEWCP1054	226	78	PEWCT1091	227		PEWTR1005	234	30
PE91144	Web		PE91300	33	D1	PEWAD5006	223	77	PEWCP1055	226	79	PEWCT1092	227		PEWTR1006	235	51
PE91145	15	A6	PE91301	33	B2	PEWAD5006	223	74	PEWCP1056	226	81	PEWCT1093	227		PEWTR1007	235	58
PE91146	15	B6	PE91302	30	D6	PEWAD5007	223	77	PEWCP1057	226	83	PEWCT1094	227		PEWTR1008	235	66
PE91147	18	D3	PE91303	Web		PEWAD5008	223	73	PEWCP1058	226	85	PEWCT1095	227		PEWTR1009	235	67
PE91148	Web		PE91304	Web		PEWAD5009	223	75	PEWCP1059	226	80	PEWCT1096	227		PEWTR1010	235	70
PE91149	28	B5	PE91305	34	C1	PEWAD5010	223	76	PEWCP1060	226	82	PEWCT1097	227		PEWTR1011	235	71
PE91150	29	A3	PE91306	34	D1	PEWAD5011	223	78	PEWCP1061	226	84	PEWCT1098	227		PEWTR1012	235	72
PE91151	28	A2	PE91307	34	D2	PEWAD5012	223	79	PEWCP1062	226	86	PEWCT1099	227		PEWTR1013	235	73
PE91152	28	C5	PE91308	34	C4	PEWAD5013	223	80	PEWCP1063	226	87	PEWCT1100	227		PEWTR1014	235	74
PE91153	Web		PE91309	31	D4	PEWAD5014	223	81	PEWCP1064	226	89	PEWCT1101	227		PEWTR1015	235	75
PE91154	28	C1	PE91310	31	A5	PEWAD5015	223	82	PEWCP1065	226	91	PEWCT1102	227		PEWTR1016	235	76
PE91155	28	B4	PE91311	31	B5	PEWAD5016	223	83	PEWCP1066	226	93	PEWCT1103	227		PEWTR1017	235	77
PE91156	29	C2	PE91312	Web		PEWAD5017	223	84	PEWCP1067	226	88	PEWCT1104	227		PEWTR1018	235	78
PE91157	Web		PE91321	29	A1	PEWAD5018	224	85	PEWCP1068	226	90	PEWCT1105	227		PEWTR1019	235	79
PE91158	14	A4	PE91324	38	D4	PEWAD5019	224	86	PEWCP1069	226	92	PEWCT1106	227		PEWTR1020	235	80
PE91159	Web		PE91325	29	D2	PEWAN1001	220	42	PEWCP1070	226	94	PEWCT1107	227		PEWTR1021	235	81
PE91160	14	B4	PE91327	28	D1	PEWAT1000-30	Web		PEWCP1071	226	95	PEWCT1108	227		PEWTR1022	235	82
PE91161	Web		PE91328	38	D2	PEWAT1001-30	Web		PEWCP1072	226	97	PEWCT1109	227		PEWTR1023	235	83
PE91162	Web		PE91329	Web		PEWAT1003-30	Web		PEWCP1073								

50-OHM CONVERSION TABLE

(dBm - volts- watts)

dBm	V	Po
+53	100.0	200W
+50	70.7	100W
+49	64.0	80W
+48	58.0	64W
+47	50.0	50W
+46	44.5	40W
+45	40.0	32W
+44	32.5	25W
+43	32.0	20W
+42	28.0	16W
+41	26.2	12.5W
+40	22.5	10W
+39	20.0	8W
+38	18.0	6.4W
+37	16.0	5W
+36	14.1	4W
+35	12.5	3.2W
+34	11.5	2.5W
+33	10.0	2W
+32	9.0	1.6W
+31	8.0	1.25W
+30	7.10	1.0W
+29	6.40	800 mW
+28	5.80	640 mW
+27	5.00	500 mW
+26	4.45	400 mW
+25	4.00	320 mW
+24	3.55	250 mW
+23	3.20	200 mW
+22	2.80	160 mW
+21	2.52	125 mW
+20	2.25	100 mW
+19	2.00	80 mW
+18	1.80	64 mW
+17	1.60	50 mW
+16	1.41	40 mW
+15	1.25	32 mW
+14	1.15	25 mW
+13	1.00	20 mW
+12	0.90	16 mW
+11	0.80	12.5 mW
+10	0.71	10 mW
+9	0.64	8 mW
+8	0.58	6.4 mW
+7	0.50	5 mW
+6	0.45	4 mW
+5	0.40	3.2 mW
+4	0.36	2.5 mW
+3	0.32	2.0 mW

dBm	V	Po
+2	0.28	1.6 mW
+1	0.25	1.25 mW
0	0.23	1.0 mW
-1	0.20	.80 mW
-2	0.18	.64 mW
-3	0.16	.50 mW
-4	0.14	.40 mW
-5	0.13	.32 mW
-6	0.12	.25 mW
-7	0.10	.20 mW
-8	0.09	.16 mW
-9	0.08	.125 mW
-10	0.07	.10 mW
-11	0.06	
-12	0.06	
-13	0.05	
-14	0.05	
-15	0.04	
-16	0.0355	
dBm	mV	Po
-17	31.5	
-18	28.5	
-19	25.1	
-20	22.5	.01 mW
-21	20.0	
-22	17.9	
-23	15.9	
-24	14.1	
-25	12.8	
-26	11.5	
-27	10.0	
-28	8.9	
-29	8.0	
-30	7.1	.001 mW
-31	6.25	
-32	5.8	
-33	5.0	
-34	4.5	
-35	4.0	
-36	3.5	
-37	3.2	
-38	2.85	
-39	2.5	
-40	2.25	.1 μ W
-41	2.0	
-42	1.8	
-43	1.6	
-44	1.4	
-45	1.25	

dBm	mV	Po
-46	1.18	
-47	1.0	
-48	0.9	
-49	0.8	
-50	0.71	.01 μ W
-51	0.64	
-52	0.57	
-53	0.5	
-54	0.45	
-55	0.4	
-56	0.351	
-57	0.32	
-58	0.286	
-59	0.251	
-60	0.225	.001 μ W
-61	0.2	
-62	0.18	
-63	0.16	
-64	0.141	
dBm	μ V	Po
-65	128	
-66	115	
-67	100	
-68	90	
-69	80	
-70	71	.1 nW
-71	65	
-72	58	
-73	50	
-74	45	
-75	40	
-76	35	
-77	32	
-78	29	
-79	25	
-80	22.5	.01 nW
-81	20	
-82	18	
-83	16	
-84	11.1	
-85	12.9	
-86	11.5	
-87	10.0	
-88	9.0	
-89	8.0	
-90	7.1	.001 nW
-91	6.1	
-92	5.75	
-93	5.0	

dBm	μ V	Po
-94	4.5	
-95	4.0	
-96	3.51	
-97	3.2	
-98	2.9	
-99	2.51	
-100	2.25	.1 pW
-101	2.0	
-102	1.8	
-103	1.6	
-104	1.41	
-105	1.27	
-106	1.18	
dBm	nV	Po
-107	1000	
-108	900	
-109	800	
-110	710	.01 pW
-109	640	
-112	580	
-113	500	
-114	450	
-115	400	
-116	355	
-117	825	
-118	285	
-119	251	
-120	225	.001 pW
-121	200	
-122	180	
-123	160	
-124	141	
-125	128	
-126	117	
-127	100	
-128	90	
-129	80	
-130	71	.1 fW
-131	61	
-132	58	
-133	50	
-134	45	
-135	40	
-136	35	
-137	33	
-138	29	
-139	25	
-140	23	.01 fW



Free Shipping Available
via UPS Ground to
USA & Canada



Technical
Support
(866) 727-8376



Same-Day Shipping,
Even Custom
Cable Assemblies

RETURN LOSS CONVERSION TABLE

Return Loss (dBm)	VSWR	Return Loss (dBm)	VSWR	Return Loss (dBm)	VSWR	Return Loss (dBm)	VSWR	Return Loss (dBm)	VSWR
46.064	1.01	13.842	1.51	9.485	2.01	7.327	2.51	5.999	3.01
40.086	1.02	13.708	1.52	9.428	2.02	7.294	2.52	5.970	3.02
36.607	1.03	13.577	1.53	9.372	2.03	7.262	2.53	5.956	3.03
34.151	1.04	13.449	1.54	9.317	2.04	7.230	2.54	5.935	3.04
32.256	1.05	13.324	1.55	9.262	2.05	7.198	2.55	5.914	3.05
30.714	1.06	13.201	1.56	9.208	2.06	7.167	2.56	5.893	3.06
29.417	1.07	13.081	1.57	9.155	2.07	7.135	2.57	5.872	3.07
28.299	1.08	12.964	1.58	9.103	2.08	7.105	2.58	5.852	3.08
27.318	1.09	12.849	1.59	9.051	2.09	7.074	2.59	5.832	3.09
26.444	1.10	12.736	1.60	8.999	2.10	7.044	2.60	5.811	3.10
25.658	1.11	12.625	1.61	8.949	2.11	7.014	2.61	5.791	3.11
24.943	1.12	12.518	1.62	8.899	2.12	6.984	2.62	5.771	3.12
24.289	1.13	12.412	1.63	8.849	2.13	6.954	2.63	5.751	3.13
23.686	1.14	12.308	1.64	8.800	2.14	6.925	2.64	5.732	3.14
23.127	1.15	12.207	1.65	8.752	2.15	6.896	2.65	5.712	3.15
22.607	1.16	12.107	1.66	8.705	2.16	6.867	2.66	5.693	3.16
22.120	1.17	12.009	1.67	8.657	2.17	6.839	2.67	5.674	3.17
21.664	1.18	11.913	1.68	8.611	2.18	6.811	2.68	5.654	3.18
21.234	1.19	11.818	1.69	8.565	2.19	6.783	2.69	5.635	3.19
20.828	1.20	11.725	1.70	8.519	2.20	6.755	2.70	5.617	3.20
20.443	1.21	11.634	1.71	8.474	2.21	6.728	2.71	5.598	3.21
20.079	1.22	11.545	1.72	8.430	2.22	6.700	2.72	5.579	3.22
19.732	1.23	11.457	1.73	8.386	2.23	6.673	2.73	5.561	3.23
19.401	1.24	11.370	1.74	8.342	2.24	6.646	2.74	5.542	3.24
19.085	1.25	11.285	1.75	8.299	2.25	6.620	2.75	5.524	3.25
18.783	1.26	11.202	1.76	8.257	2.26	6.594	2.76	5.506	3.26
18.493	1.27	11.120	1.77	8.215	2.27	6.567	2.77	5.488	3.27
18.216	1.28	11.039	1.78	8.173	2.28	6.541	2.78	5.470	3.28
17.949	1.29	10.960	1.79	8.138	2.29	6.516	2.79	5.452	3.29
17.690	1.30	10.881	1.80	8.091	2.30	6.490	2.80	5.435	3.30
17.445	1.31	10.804	1.81	8.051	2.31	6.465	2.81	5.417	3.31
17.207	1.32	10.729	1.82	8.011	2.32	6.440	2.82	5.400	3.32
16.977	1.33	10.654	1.83	7.972	2.33	6.415	2.83	5.383	3.33
16.755	1.34	10.581	1.84	7.933	2.34	6.390	2.84	5.365	3.34
16.540	1.35	10.509	1.85	7.894	2.35	6.366	2.85	5.348	3.35
16.332	1.36	10.437	1.86	7.856	2.36	6.341	2.86	5.331	3.36
16.131	1.37	10.367	1.87	7.818	2.37	6.317	2.87	5.315	3.37
15.936	1.38	10.298	1.88	7.781	2.38	6.293	2.88	5.298	3.38
15.747	1.39	10.230	1.89	7.744	2.39	6.270	2.89	5.281	3.39
15.563	1.40	10.163	1.90	7.707	2.40	6.246	2.90	5.265	3.40
15.385	1.41	10.097	1.91	7.671	2.41	6.223	2.91	5.248	3.41
15.211	1.42	10.032	1.92	7.635	2.42	6.200	2.92	5.232	3.42
15.043	1.43	9.968	1.93	7.599	2.43	6.177	2.93	5.216	3.43
14.879	1.44	9.904	1.94	7.564	2.44	6.154	2.94	5.200	3.44
14.719	1.45	9.842	1.95	7.529	2.45	6.131	2.95	5.184	3.45
14.564	1.46	9.780	1.96	7.494	2.46	6.109	2.96	5.168	3.46
14.412	1.47	9.720	1.97	7.460	2.47	6.086	2.97	5.152	3.47
14.264	1.48	9.660	1.98	7.426	2.48	6.064	2.98	5.137	3.48
14.120	1.49	9.601	1.99	7.393	2.49	6.042	2.99	5.121	3.49
13.979	1.50	9.542	2.00	7.360	2.50	6.021	3.00	5.105	3.50

MOUNTING HOLES

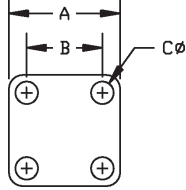

CODE	A	B	C
A01	.500	.340	.102
A02	.687	.500	.109
A03	.687	.500	#3-56 TAP
A04	.687	.500	.125
A05	1.000	.718	.125
A06	.750	.531	.140
A07	.750	.531	.125
A08	1.190	.906	.125
A09	.687	.500	#4-40 TAP
A10	.687	.500	.136
A11	1.250	.975	.147
A12	2.000	1.440	.257
A13	1.000	.718	.141
A14	1.000	.718	.144
A15	.687	.500	.104
A16	.750	.531	.136
A17	.375	.232	.067
A18	.625	.437	.094
A19	1.000	.718	#6-32 TAP
A20	.500	.340	#2-56 TAP
A21	1.250	.975	.142
A22	.375	.232	.093

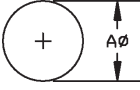

CODE	A
F01	.250
F02	.500
F03	.630
F04	1.200
F05	.380
F06	.450
F07	.200
F08	.362
F09	.220
F10	.317
F11	4.83mm
F12	.390

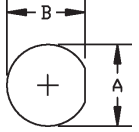

CODE	A	B
B01	.195	.177
B02	.250	.235
B03	.330	.295
B04	.380	.350
B05	.440	.410
B06	.512	.480
B07	.760	.720
B08	.565	.537
B09	.314	.296
B10	.140	.126
B11	.695	.655
B12	.625	.575
B13	.405	.361
B14	.277	.252
B15	.630	.596
B16	.317	.285
B17	.284	.268

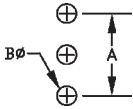

CODE	A	B
J01	.200	.046

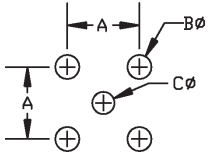

CODE	A	B	C
D01	.200	.067	.062
D02	.200	.067	.046
D03	.100	.031	.031
D04	.200	.052	.052
D05	.260	.067	.043
D06	.200	.052	.047
D07	.200	.055	.043
D08	.200	.067	.035
D09	.200	.055	.028
D10	.200	.055	.035
D11	.320	.091	.031
D12	.400	.062	.062
D13	.320	.091	.091
D14	.340	.091	.043
D15	.164	.067	.091
D16	.500	.126	.440
D17	.380	.083	.043

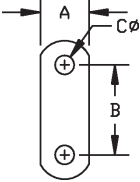

CODE	A	B	C
C01	.223	.481	.102
C02	.260	.481	.102
C03	.192	.328	.067
C04	.640	1.000	.125
C05	.275	.481	.102
C06	.230	.354	.067
C07	.188	.328	.093

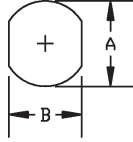

CODE	A	B
G01	.640	.546
G02	.380	.340
G03	.765	.712
G04	.362	.323
G05	.236	.197
G06	.217	.177
G07	.380	.310
G08	1.161	1.000

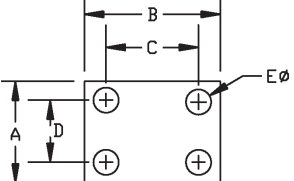

CODE	A	B	C	D	E
E01	.375	.500	.340	.222	.093

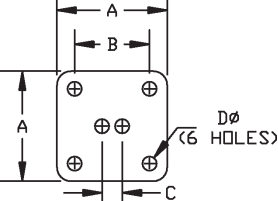

CODE	A	B	C	D
H01	.687	.500	.125	.045



Free Shipping Available
via UPS Ground to
USA & Canada



Technical
Support
(866) 727-8376



Same-Day Shipping,
Even Custom
Cable Assemblies

CONNECTOR IDENTIFIER

SPECIFICATIONS SHOWN ARE INTENDED FOR IDENTIFICATION PURPOSES ONLY











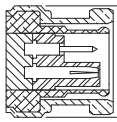
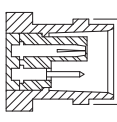
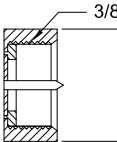
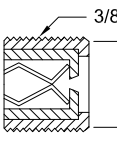
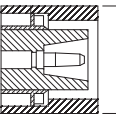
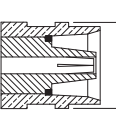
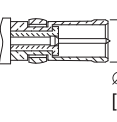
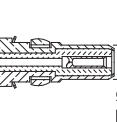
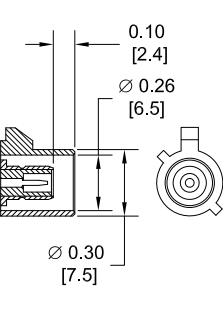
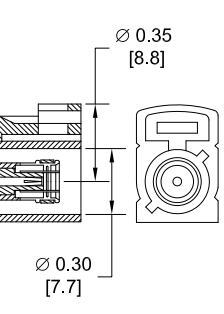





1.0/2.3 SLIDE ON	PLUG	
	JACK	
1.85 mm**	MALE	
	FEMALE	
2.4 mm**	MALE	
	FEMALE	
2.92 mm*	MALE	
	FEMALE	
3.5 mm*	MALE	
	FEMALE	
7 mm	MALE	
	FEMALE	
7/16	PLUG	
	JACK	
3/4-20 TWINAX	MALE	
	FEMALE	
10 - 32	MALE	
	FEMALE	
BANANA	PLUG	
	JACK	
BNC	MALE	
	FEMALE	
REVERSE POLARITY BNC	MALE	
	FEMALE	
75 OHM BNC	MALE	
	FEMALE	
1.0/2.3 SNAP ON	PLUG	
	JACK	
1.6/56	PLUG	
	JACK	

*SMA, 2.92mm, & 3.5mm CONNECTORS WILL MATE MECHANICALLY & ELECTRICALLY TO EACH OTHER.

**1.85mm & 2.4mm CONNECTORS WILL MATE MECHANICALLY & ELECTRICALLY TO EACH OTHER.

CONNECTOR IDENTIFIER

SPECIFICATIONS SHOWN ARE INTENDED FOR IDENTIFICATION PURPOSES ONLY

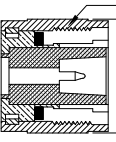
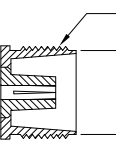
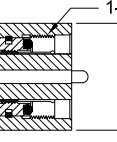
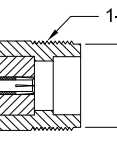
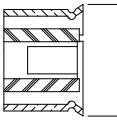
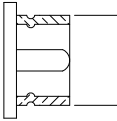
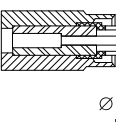
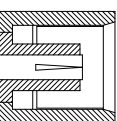
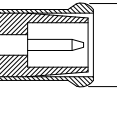
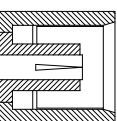
BNC TWINAX	PLUG	 Ø 0.57" [14.5mm]				
	JACK	 Ø 0.44" [11.1mm]				
F	MALE	 3/8-32 7/16 HEX				
	FEMALE	 3/8-32 Ø 0.34 [8.5]				
C	MALE	 Ø 0.75" [19.1mm]				
	FEMALE	 Ø 0.60" [15.2mm]				
D SUBMINIATURE	PLUG	 Ø 0.19" [4.8mm]				
	RECEPTACLE	 Ø 0.15" [3.9mm]				
FAKRA	PLUG	 0.10 [2.4] Ø 0.26 [6.5] Ø 0.30 [7.5]				
	JACK	 Ø 0.35 [8.8] Ø 0.30 [7.7]				
FAKRA	COMPLETE KEY CODE INFO	CODE	JACK	PLUG	COLOR	APPLICATION
		A			BLACK	RADIO WITH PHANTOM SUPPLY
		B			WHITE	RADIO WITHOUT PHANTOM SUPPLY
		C			BLUE	GPS: TELEMATICS OR NAVIGATION
D			BORDEAUX	GSM: CELLULAR PHONE		
H			VIOLET	GPS: TELEMATICS AND NAVIGATION		
I			BEIGE	BLUETOOTH		
K			CURRY	RADIO WITH I.F. OUTPUT (ANTENNA DIVERSITY)		
Z			WATER BLUE	NEUTRAL CODING		
GR874	MALE	 3/4-20 Ø 0.90 [22.9]				
	FEMALE	 3/4-20 Ø 0.67 [17.1]				
LC	MALE	 1-1/4-18 1-1/2 HEX				
	FEMALE	 1-1/4-18 Ø 1.17 [29.6]				
UMCX	PLUG	 Ø 0.10 [2.5]				
	JACK	 Ø 0.08 [2.0]				
MC-CARD	PLUG	 Ø 0.087 [2.2]				
	JACK	 Ø 0.20 [5.0]				
MCX	PLUG	 Ø 0.15 [3.7]				
	JACK	 Ø 0.20 [5.0]				



CONNECTOR IDENTIFIER

SPECIFICATIONS SHOWN ARE INTENDED FOR IDENTIFICATION PURPOSES ONLY

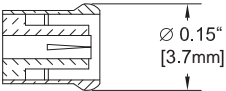
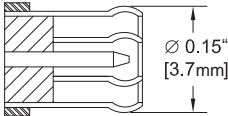
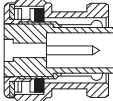
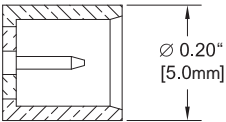
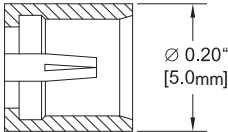
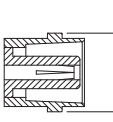
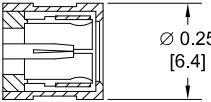
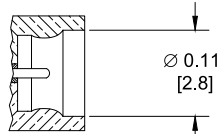
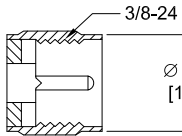
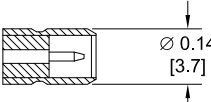
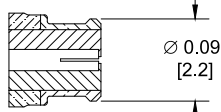
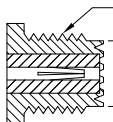
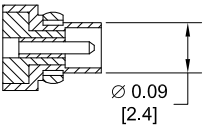
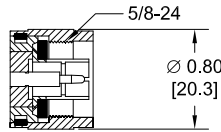
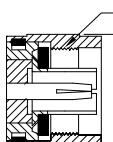
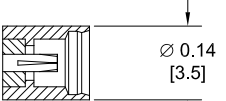
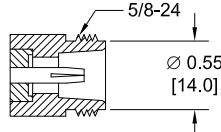
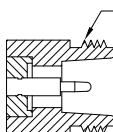
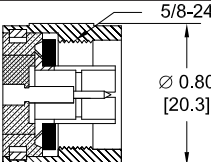
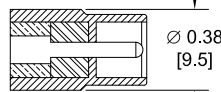
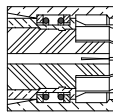
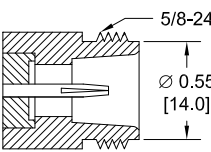
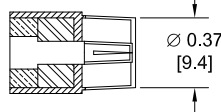
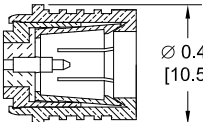
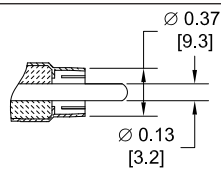
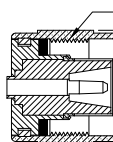
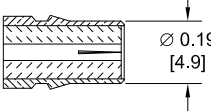
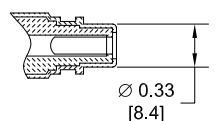
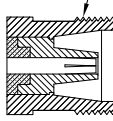
REVERSE POLARITY MCX	PLUG	 Ø 0.15" [3.7mm]	75 OHM MCX	PLUG	 Ø 0.15" [3.7mm]	MHV	MALE	 Ø 0.57" [14.5mm]
	JACK	 Ø 0.20" [5.0mm]		JACK	 Ø 0.20" [5.0mm]		FEMALE	 Ø 0.44" [11.1mm]
MINI 75 OHM SMB	PLUG	 Ø 0.25 [6.4]	MINI SMP	MALE	 Ø 0.11" [2.8]	MINI-UHF	MALE	 3/8-24 Ø 0.45 [11.5]
	JACK	 Ø 0.14 [3.7]		FEMALE	 Ø 0.09" [2.2]		FEMALE	 3/8-24 Ø 0.31 [7.8]
MMCX	PLUG	 Ø 0.09 [2.4]	N	MALE	 5/8-24 Ø 0.80 [20.3]	REVERSE POLARITY N	MALE	 5/8-24 Ø 0.80 [20.3]
	JACK	 Ø 0.14 [3.5]		FEMALE	 5/8-24 Ø 0.55 [14.0]		FEMALE	 5/8-24 Ø 0.55 [14.0]
75 OHM N	MALE	 5/8-24 Ø 0.80 [20.3]	PAL	PLUG	 Ø 0.38 [9.5]	POSITIVE SNAP	 Ø 0.39 [9.9]	
	FEMALE	 5/8-24 Ø 0.55 [14.0]		JACK	 Ø 0.37 [9.4]			
OMA	MALE	 Ø 0.41 [10.5]	RCA	PLUG	 Ø 0.37 [9.3] Ø 0.13 [3.2]	SC	MALE	 11/16-24 Ø 0.80 [20.3]
	FEMALE	 Ø 0.19 [4.9]		JACK	 Ø 0.33 [8.4]		FEMALE	 11/16-24 Ø 0.63 [15.9]

CONNECTOR IDENTIFIER

SPECIFICATIONS SHOWN ARE INTENDED FOR IDENTIFICATION PURPOSES ONLY

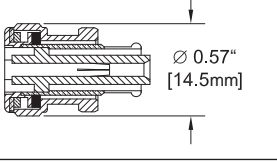
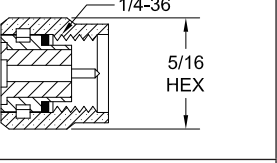
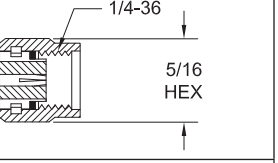
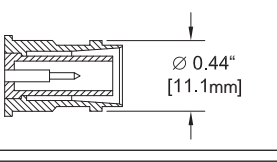
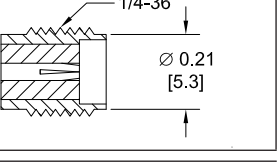
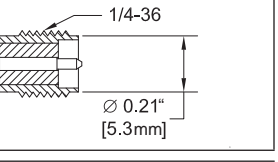
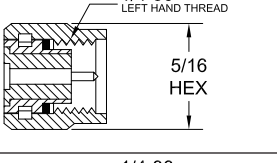
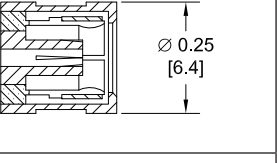
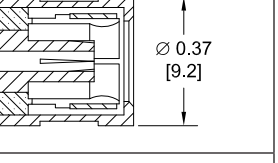
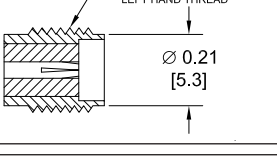
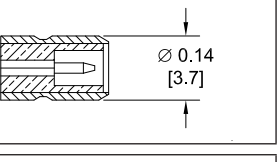
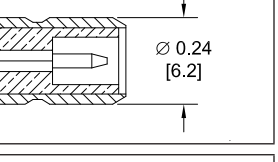
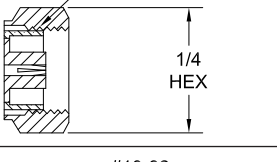
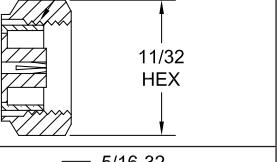
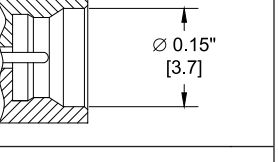
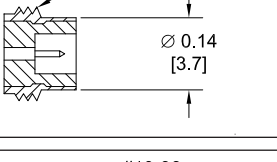
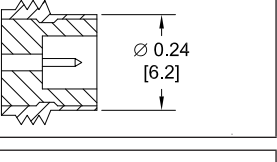
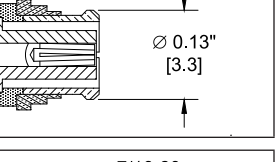
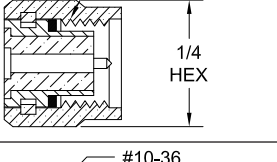
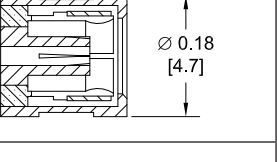
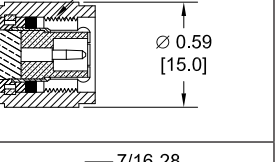
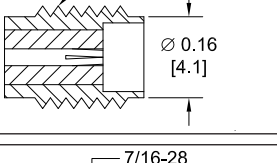
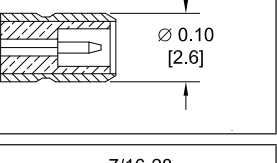
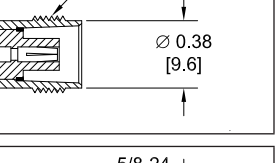
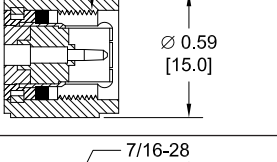
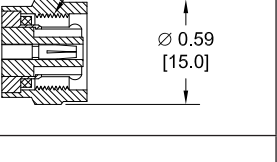
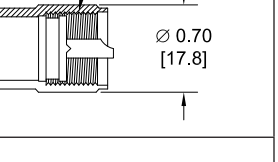
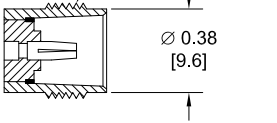
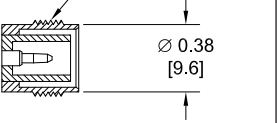
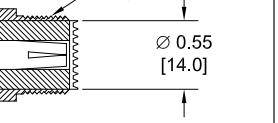
SHV	PLUG	 Ø 0.57" [14.5mm]	SMA*	MALE	 1/4-36 5/16 HEX	REVERSE POLARITY SMA	MALE	 1/4-36 5/16 HEX
	JACK	 Ø 0.44" [11.1mm]		FEMALE	 1/4-36 Ø 0.21 [5.3]		FEMALE	 1/4-36 Ø 0.21" [5.3mm]
SMA REVERSE THREAD	MALE	 1/4-36 LEFT HAND THREAD 5/16 HEX	SMB	PLUG	 Ø 0.25 [6.4]	75 OHM SMB	PLUG	 Ø 0.37 [9.2]
	FEMALE	 1/4-36 LEFT HAND THREAD Ø 0.21 [5.3]		JACK	 Ø 0.14 [3.7]		JACK	 Ø 0.24 [6.2]
SMC	PLUG	 #10-32 1/4 HEX	75 OHM SMC	PLUG	 5/16-32 11/32 HEX	SMP	MALE	 Ø 0.15" [3.7]
	JACK	 #10-32 Ø 0.14 [3.7]		JACK	 5/16-32 Ø 0.24 [6.2]		FEMALE	 Ø 0.13" [3.3]
SSMA	MALE	 #10-36 1/4 HEX	SSMB	PLUG	 Ø 0.18 [4.7]	TNC	MALE	 7/16-28 Ø 0.59 [15.0]
	FEMALE	 #10-36 Ø 0.16 [4.1]		JACK	 Ø 0.10 [2.6]		FEMALE	 7/16-28 Ø 0.38 [9.6]
75 OHM TNC	MALE	 7/16-28 Ø 0.59 [15.0]	REVERSE POLARITY TNC	MALE	 7/16-28 Ø 0.59 [15.0]	UHF	MALE	 5/8-24 Ø 0.70 [17.8]
	FEMALE	 7/16-28 Ø 0.38 [9.6]		FEMALE	 7/16-28 Ø 0.38 [9.6]		FEMALE	 5/8-24 Ø 0.55 [14.0]

*SMA, 2.92mm & 3.5mm CONNECTORS WILL MATE MECHANICALLY & ELECTRICALLY TO EACH OTHER.



Free Shipping Available
via UPS Ground to
USA & Canada



Technical
Support
(866) 727-8376



Same-Day Shipping,
Even Custom
Cable Assemblies

CONNECTOR FREQUENCY RANGE CHART

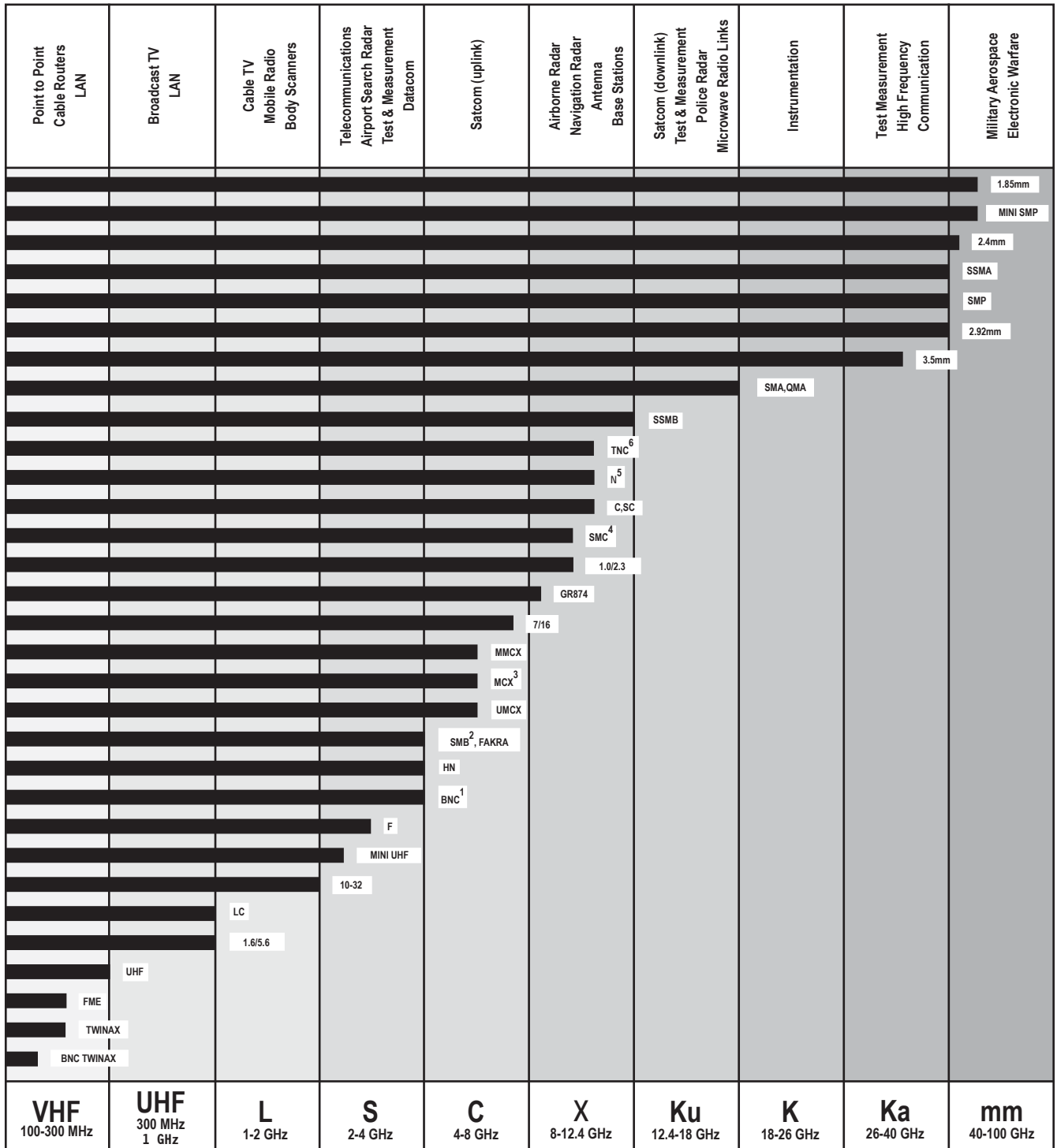

Notes:

- 1: BNC-75 Ohm connectors operate up to 1 GHz
- 2: SMB-75 Ohm & Mini SMB-75 Ohm connectors operate up to 4 GHz
- 3: MCX-75 Ohm connectors operate up to 6 GHz
- 4: SMC-75 Ohm connectors operate up to 10 GHz
- 5: N-75 Ohm connectors operate up to 1.5 GHz
- 6: TNC-75 Ohm connectors operate up to 1 GHz



Australian Representatives
ROJONE, PTY LTD.
Tel: 02 9829 1555
E: sales@rojone.com.au
www.rojone.com.au