

Pasternack

# RF Product Guide 2019

Connectors

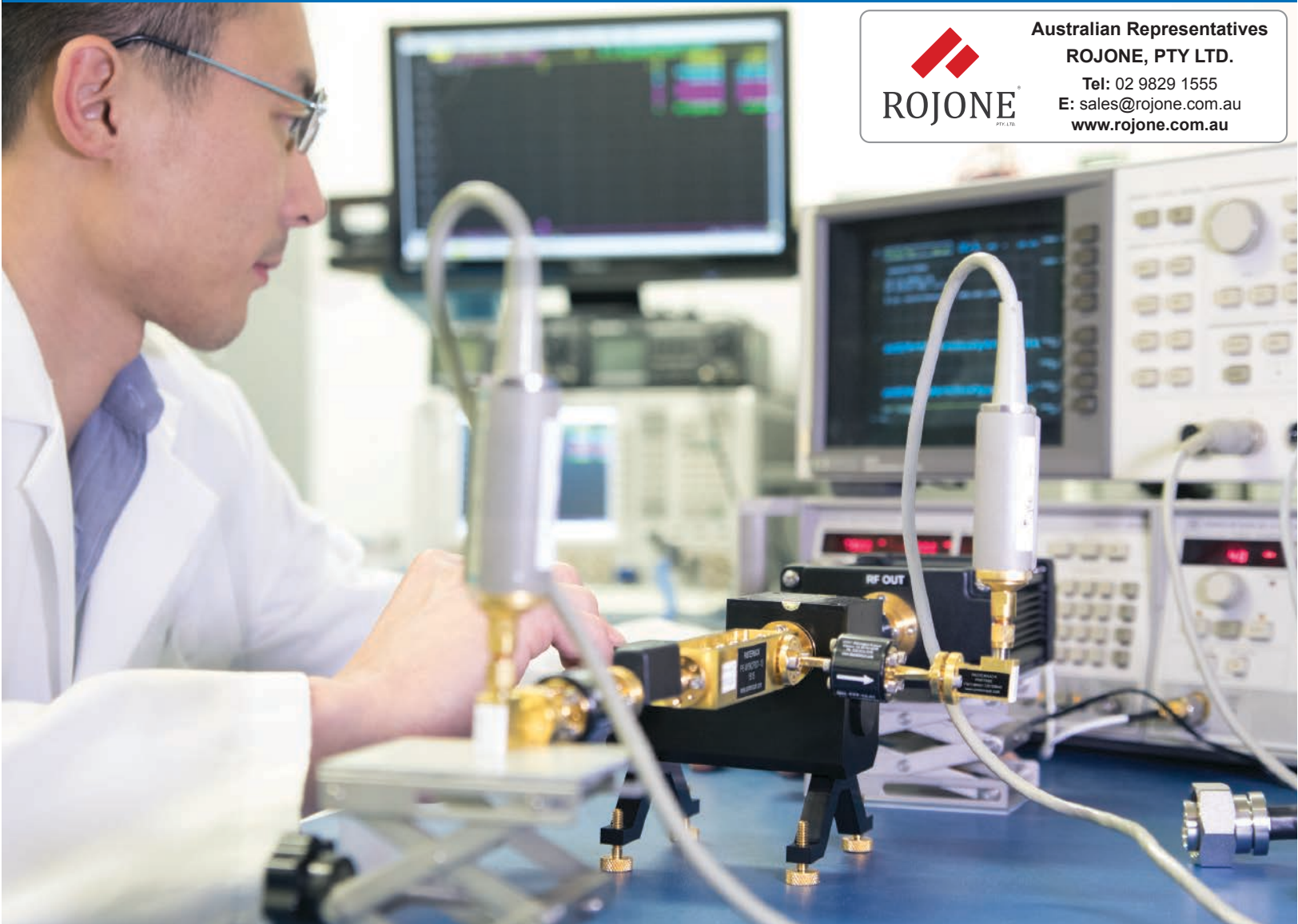

Australian Representatives

ROJONE, PTY LTD.

Tel: 02 9829 1555

E: sales@rojone.com.au

www.rojone.com.au



**Largest Selection ✓ Same-Day Shipping ✓ Expert Technical Support ✓**

866.727.8376 | sales@pasternack.com

**PE PASTERNAK®**  
THE ENGINEER'S RF SOURCE

# Connector Selection Guide

## 3 Easy Ways to Find your Product.....

### 1. Search by PE Part Number

If you know the PE part number you are searching for, please reference our Part Number Index on Page 245

### 2. Quick Reference Guide

(Page number refers to first appearance of product in the Connector Section)

Connector Series	Page	Connector Series	Page	Connector Series	Page	Connector Series	Page
1.0/2.3	<a href="#">116</a>	75 Ohm MCX	<a href="#">158</a>	HN	<a href="#">128</a>	Rev. Pol. TNC	<a href="#">155</a>
1.0mm	<a href="#">116</a>	75 Ohm Mini SMB	<a href="#">158</a>	LC	<a href="#">129</a>	Reverse Thread SMA	<a href="#">145</a>
1.85mm	<a href="#">116</a>	75 Ohm N	<a href="#">158</a>	MCX	<a href="#">129</a>	SC	<a href="#">139</a>
10-32	<a href="#">121</a>	75 Ohm RCA	<a href="#">159</a>	MHV	<a href="#">130</a>	SHV	<a href="#">139</a>
2.4mm	<a href="#">117</a>	75 Ohm SMB	<a href="#">159</a>	Mini SMP	<a href="#">131</a>	SMA	<a href="#">142</a>
2.92mm	<a href="#">118</a>	75 Ohm SMC	<a href="#">160</a>	Mini UHF	<a href="#">132</a>	SMB	<a href="#">146</a>
3.5mm	<a href="#">119</a>	75 Ohm TNC	<a href="#">161</a>	MMBX	<a href="#">133</a>	SMC	<a href="#">147</a>
3/4"-20 Twinax	<a href="#">162</a>	BMA	<a href="#">122</a>	MMCX	<a href="#">132</a>	SMP	<a href="#">149</a>
4.1/9.5 Mini DIN	<a href="#">119</a>	BNC	<a href="#">124</a>	N	<a href="#">135</a>	SSMA	<a href="#">150</a>
4.3-10	<a href="#">119</a>	BNC Twinax	<a href="#">161</a>	QMA	<a href="#">138</a>	SSMB	<a href="#">151</a>
7/16 DIN	<a href="#">120</a>	C	<a href="#">126</a>	QN	<a href="#">138</a>	SSMC	<a href="#">151</a>
75 Ohm 1.0/2.3	<a href="#">156</a>	D-Sub	<a href="#">127</a>	Rev. Pol. BNC	<a href="#">126</a>	TNC	<a href="#">153</a>
75 Ohm BNC	<a href="#">157</a>	FAKRA	<a href="#">127</a>	Rev. Pol. MCX	<a href="#">130</a>	UHF	<a href="#">155</a>
75 Ohm F	<a href="#">157</a>	GR874	<a href="#">128</a>	Rev. Pol. N	<a href="#">137</a>	UMCX	<a href="#">156</a>
				Rev. Pol. SMA	<a href="#">145</a>		

Connectors

### 3. Connector Locator

Connector Type	Page
<b>1.0/2.3 Jack Connectors</b>	
Right Angle, PCB Mount	<a href="#">116</a>
Straight, Bulkhead, Cable Connectors	<a href="#">116</a>
Straight, Bulkhead, PCB Mount	<a href="#">116</a>
Straight, PCB Mount	<a href="#">116</a>
<b>1.0/2.3 Plug Connectors</b>	
Right Angle, Cable Connectors	<a href="#">116</a>
Straight, Cable Connectors	<a href="#">116</a>
<b>1.0mm Female Connectors</b>	
Straight, PCB Mount	<a href="#">116</a>
<b>1.85mm Female Connectors</b>	
Straight, Bulkhead, Cable Connectors	<a href="#">117</a>
Straight, Cable Connectors	<a href="#">116</a>
Straight, PCB Mount	<a href="#">117</a>
<b>1.85mm Male Connectors</b>	
Straight, Cable Connectors	<a href="#">116</a>
<b>10-32 Female Connectors</b>	
Right Angle, PCB Mount	<a href="#">122</a>
Straight, Bulkhead, Cable Connectors	<a href="#">121</a>
Straight, Bulkhead, Terminal	<a href="#">121</a>
Straight, Cable Connectors	<a href="#">121</a>
Straight, PCB Mount	<a href="#">121</a>
<b>10-32 Male Connectors</b>	

Connector Type	Page
Right Angle, Cable Connectors	<a href="#">121</a>
Straight, Cable Connectors	<a href="#">121</a>
<b>2.4mm Female Connectors</b>	
Straight, 2 Hole Flange, Terminal	<a href="#">117</a>
Straight, 4 Hole Flange, Terminal	<a href="#">117</a>
Straight, Bulkhead, Cable Connectors	<a href="#">117</a>
Straight, PCB Mount	<a href="#">117</a>
<b>2.4mm Male Connectors</b>	
Straight, Cable Connectors	<a href="#">117</a>
Straight, PCB Mount	<a href="#">117</a>
<b>2.92mm Female Connectors</b>	
Straight, 2 Hole Flange, Field Replaceable Contact	<a href="#">118</a>
Straight, 4 Hole Flange, Field Replaceable Contact	<a href="#">118</a>
Straight, Bulkhead, Cable Connectors	<a href="#">118</a>
Straight, Cable Connectors	<a href="#">118</a>
Straight, PCB Mount	<a href="#">118</a>
Straight, Threaded, Field Replaceable Contact	<a href="#">118</a>
<b>2.92mm Male Connectors</b>	
Straight, 2 Hole Flange, Terminal	<a href="#">118</a>
Straight, Cable Connectors	<a href="#">117</a>
Straight, PCB Mount	<a href="#">117</a>
Straight, Threaded, Field Replaceable Contact	<a href="#">118</a>
<b>3.5mm Female Connectors</b>	



Free Shipping Available  
via UPS Ground  
to USA & Canada



Technical  
Support  
(866) 727-8376



Same-Day Shipping,  
Even Custom  
Cable Assemblies

# Connector Locator

Connector Type	Page
Straight, Bulkhead, Cable Connectors	<a href="#">119</a>
<b>3.5mm Male Connectors</b>	
Straight, Cable Connectors	<a href="#">118</a>
<b>4.1/9.5 Mini DIN Female Connectors</b>	
Straight, Cable Connectors	<a href="#">119</a>
<b>4.1/9.5 Mini DIN Male Connectors</b>	
Right Angle, Cable Connectors	<a href="#">119</a>
Straight, Cable Connectors	<a href="#">119</a>
<b>4.3-10 Female Connectors</b>	
Straight, 4 Hole Flange, Cable Connectors	<a href="#">120</a>
Straight, 4 Hole Flange, Terminal	<a href="#">120</a>
Straight, Cable Connectors	<a href="#">119</a>
<b>4.3-10 Male Connectors</b>	
Right Angle, Cable Connectors	<a href="#">119</a>
Straight, Cable Connectors	<a href="#">119</a>
<b>7/16 DIN Female Connectors</b>	
Straight, 4 Hole Flange, Cable Connectors	<a href="#">121</a>
Straight, 4 Hole Flange, Terminal	<a href="#">121</a>
Straight, Bulkhead, Cable Connectors	<a href="#">121</a>
Straight, Bulkhead, Terminal	<a href="#">121</a>
Straight, Cable Connectors	<a href="#">120</a>
<b>7/16 DIN Male Connectors</b>	
Right Angle, Cable Connectors	<a href="#">120</a>
Straight, Cable Connectors	<a href="#">120</a>
<b>75 Ohm 1.0/2.3 Jack Connectors</b>	
Right Angle, Bulkhead, PCB Mount	<a href="#">156</a>
Straight, Bulkhead, PCB Mount	<a href="#">156</a>
<b>75 Ohm 1.0/2.3 Plug Connectors</b>	
Straight, Cable Connectors	<a href="#">156</a>
<b>75 Ohm BNC Female Connectors</b>	
Straight, 4 Hole Flange, Terminal	<a href="#">157</a>
Straight, Bulkhead, Cable Connectors	<a href="#">157</a>
Straight, Bulkhead, Terminal	<a href="#">157</a>
Straight, Cable Connectors	<a href="#">157</a>
<b>75 Ohm BNC Male Connectors</b>	
Right Angle, Cable Connectors	<a href="#">157</a>
Straight, Cable Connectors	<a href="#">156</a>
<b>75 Ohm F Female Connectors</b>	
Straight, Bulkhead, Cable Connectors	<a href="#">157</a>
<b>75 Ohm F Male Connectors</b>	
Right Angle, Cable Connectors	<a href="#">157</a>
Straight, Cable Connectors	<a href="#">157</a>
<b>75 Ohm MCX Plug Connectors</b>	
Right Angle, Cable Connectors	<a href="#">158</a>
Straight, Cable Connectors	<a href="#">158</a>
<b>75 Ohm Mini SMB Jack Connectors</b>	
Straight, PCB Mount	<a href="#">158</a>
<b>75 Ohm Mini SMB Plug Connectors</b>	
Right Angle, Cable Connectors	<a href="#">158</a>
Straight, Cable Connectors	<a href="#">158</a>
<b>75 Ohm N Female Connectors</b>	
Straight, 4 Hole Flange, Terminal	<a href="#">159</a>

Connector Type	Page
Straight, Bulkhead, Terminal	<a href="#">159</a>
Straight, Cable Connectors	<a href="#">158</a>
<b>75 Ohm N Male Connectors</b>	
Right Angle, Cable Connectors	<a href="#">158</a>
Straight, 4 Hole Flange, Terminal	<a href="#">158</a>
Straight, Cable Connectors	<a href="#">158</a>
<b>75 Ohm RCA Female Connectors</b>	
Straight, Bulkhead, Cable Connectors	<a href="#">159</a>
<b>75 Ohm RCA Male Connectors</b>	
Straight, Cable Connectors	<a href="#">159</a>
<b>75 Ohm SMB Jack Connectors</b>	
Right Angle, PCB Mount	<a href="#">159</a>
Straight, PCB Mount	<a href="#">159</a>
<b>75 Ohm SMB Plug Connectors</b>	
Straight, Bulkhead, Terminal	<a href="#">159</a>
Straight, Cable Connectors	<a href="#">159</a>
<b>75 Ohm SMC Jack Connectors</b>	
Right Angle, PCB Mount	<a href="#">160</a>
Straight, Bulkhead, Cable Connectors	<a href="#">160</a>
Straight, Bulkhead, Terminal	<a href="#">160</a>
Straight, Cable Connectors	<a href="#">160</a>
Straight, PCB Mount	<a href="#">160</a>
<b>75 Ohm SMC Plug Connectors</b>	
Right Angle, Cable Connectors	<a href="#">160</a>
Right Angle, PCB Mount	<a href="#">160</a>
Straight, Cable Connectors	<a href="#">160</a>
<b>75 Ohm TNC Female Connectors</b>	
Straight, Bulkhead, Cable Connectors	<a href="#">161</a>
Straight, Bulkhead, Terminal	<a href="#">161</a>
<b>75 Ohm TNC Male Connectors</b>	
Right Angle, Cable Connectors	<a href="#">160</a>
Straight, Cable Connectors	<a href="#">160</a>
<b>78 Ohm BNC Twinax Jack Connectors</b>	
Right Angle, PCB Mount	<a href="#">161</a>
Straight, 4 Hole Flange, Terminal	<a href="#">161</a>
Straight, Bulkhead, Cable Connectors	<a href="#">161</a>
Straight, Bulkhead, Terminal	<a href="#">161</a>
Straight, Cable Connectors	<a href="#">161</a>
Straight, PCB Mount	<a href="#">161</a>
<b>78 Ohm BNC Twinax Plug Connectors</b>	
Straight, Cable Connectors	<a href="#">161</a>
<b>95 Ohm 3/4"-20 Twinax Female Connectors</b>	
Straight, 4 Hole Flange, Terminal	<a href="#">162</a>
Straight, Bulkhead, Terminal	<a href="#">162</a>
<b>95 Ohm 3/4"-20 Twinax Male Connectors</b>	
Straight, Cable Connectors	<a href="#">161</a>
<b>BMA Jack Connectors</b>	
Right Angle, 2 Hole Flange, Cable Connectors	<a href="#">123</a>
Straight, 2 Hole Flange, Cable Connectors	<a href="#">123</a>
Straight, 2 Hole Flange, Terminal	<a href="#">123</a>
Straight, 4 Hole Flange, Terminal	<a href="#">123</a>

# Connector Locator

Connector Type	Page
Straight, Bulkhead, Cable Connectors	<a href="#">123</a>
Straight, Cable Connectors	<a href="#">122</a>
Straight, PCB Mount	<a href="#">123</a>
Straight, Terminal	<a href="#">123</a>
Straight, Thread-In, Terminal	<a href="#">123</a>
<b>BMA Plug Connectors</b>	
Right Angle, PCB Mount	<a href="#">122</a>
Straight, 2 Hole Flange, Field Replaceable Contact	<a href="#">122</a>
Straight, 2 Hole Flange, Terminal	<a href="#">122</a>
Straight, 4 Hole Flange, Terminal	<a href="#">122</a>
Straight, Bulkhead, Cable Connectors	<a href="#">122</a>
Straight, PCB Mount	<a href="#">122</a>
Straight, Thread-In, Terminal	<a href="#">122</a>
<b>BNC Female Connectors</b>	
Right Angle, 4 Hole Flange, Terminal	<a href="#">125</a>
Right Angle, Bulkhead, Terminal	<a href="#">125</a>
Straight, 4 Hole Flange, Cable Connectors	<a href="#">125</a>
Straight, 4 Hole Flange, Terminal	<a href="#">125</a>
Straight, Bulkhead, Cable Connectors	<a href="#">125</a>
Straight, Bulkhead, Terminal	<a href="#">125</a>
Straight, Cable Connectors	<a href="#">124</a>
<b>BNC Male Connectors</b>	
Right Angle, Cable Connectors	<a href="#">124</a>
Straight, 4 Hole Flange, Terminal	<a href="#">124</a>
Straight, Bulkhead, Terminal	<a href="#">124</a>
Straight, Cable Connectors	<a href="#">123</a>
<b>C Female Connectors</b>	
Straight, 4 Hole Flange, Cable Connectors	<a href="#">126</a>
Straight, 4 Hole Flange, Terminal	<a href="#">127</a>
Straight, Bulkhead, Cable Connectors	<a href="#">126</a>
Straight, Bulkhead, Terminal	<a href="#">126</a>
Straight, Cable Connectors	<a href="#">126</a>
<b>C Male Connectors</b>	
Right Angle, Cable Connectors	<a href="#">126</a>
Straight, 4 Hole Flange, Terminal	<a href="#">126</a>
Straight, Cable Connectors	<a href="#">126</a>
<b>D-Sub Plug Connectors</b>	
Right Angle, PCB Mount	<a href="#">127</a>
Straight, Cable Connectors	<a href="#">127</a>
<b>D-Sub Receptacle Connectors</b>	
Right Angle, Cable Connectors	<a href="#">127</a>
Straight, Cable Connectors	<a href="#">127</a>
<b>FAKRA Jack Connectors</b>	
Right Angle, Cable Connectors	<a href="#">127</a>
Right Angle, PCB Mount	<a href="#">128</a>
Straight, Cable Connectors	<a href="#">127</a>
<b>FAKRA Plug Connectors</b>	
Right Angle, PCB Mount	<a href="#">127</a>
Straight, Cable Connectors	<a href="#">127</a>
Straight, PCB Mount	<a href="#">127</a>
<b>GR874 Sexless Connectors</b>	

Connector Type	Page
Straight, Cable Connectors	<a href="#">128</a>
<b>HN Female Connectors</b>	
Straight, 4 Hole Flange, Terminal	<a href="#">128</a>
Straight, Bulkhead, Terminal	<a href="#">128</a>
Straight, Cable Connectors	<a href="#">128</a>
<b>HN Male Connectors</b>	
Right Angle, Cable Connectors	<a href="#">128</a>
Straight, Cable Connectors	<a href="#">128</a>
<b>LC Female Connectors</b>	
Straight, 4 Hole Flange, Terminal	<a href="#">129</a>
Straight, Cable Connectors	<a href="#">129</a>
<b>LC Male Connectors</b>	
Right Angle, Cable Connectors	<a href="#">129</a>
Straight, Cable Connectors	<a href="#">129</a>
<b>MCX Jack Connectors</b>	
Right Angle, PCB Mount	<a href="#">130</a>
Straight, 2 Hole Flange, Terminal	<a href="#">130</a>
Straight, Bulkhead, Cable Connectors	<a href="#">130</a>
Straight, Bulkhead, Terminal	<a href="#">130</a>
Straight, Cable Connectors	<a href="#">129</a>
Straight, PCB Mount	<a href="#">129</a>
<b>MCX Plug Connectors</b>	
Right Angle, Cable Connectors	<a href="#">129</a>
Straight, Cable Connectors	<a href="#">129</a>
Straight, PCB Mount	<a href="#">129</a>
<b>MHV Female Connectors</b>	
Straight, 4 Hole Flange, Cable Connectors	<a href="#">131</a>
Straight, 4 Hole Flange, Terminal	<a href="#">131</a>
Straight, Bulkhead, Cable Connectors	<a href="#">131</a>
Straight, Bulkhead, Terminal	<a href="#">131</a>
Straight, Cable Connectors	<a href="#">130</a>
<b>MHV Male Connectors</b>	
Right Angle, Cable Connectors	<a href="#">130</a>
Straight, Cable Connectors	<a href="#">130</a>
<b>Mini SMP Female Connectors</b>	
Right Angle, Cable Connectors	<a href="#">131</a>
Straight, Cable Connectors	<a href="#">131</a>
<b>Mini SMP Male Connectors</b>	
Right Angle, PCB Mount	<a href="#">131</a>
Straight, PCB Mount	<a href="#">131</a>
<b>Mini UHF Female Connectors</b>	
Straight, Bulkhead, Cable Connectors	<a href="#">132</a>
Straight, Bulkhead, PCB Mount	<a href="#">132</a>
<b>Mini UHF Male Connectors</b>	
Straight, Cable Connectors	<a href="#">131</a>
<b>MMBX Jack Connectors</b>	
Straight, PCB Mount	<a href="#">133</a>
Straight, Thread-In, Terminal	<a href="#">133</a>
<b>MMBX Plug Connectors</b>	
Right Angle, Cable Connectors	<a href="#">133</a>
Straight, Cable Connectors	<a href="#">132</a>



Free Shipping Available  
via UPS Ground  
to USA & Canada



Technical  
Support  
(866) 727-8376



Same-Day Shipping,  
Even Custom  
Cable Assemblies

# Connector Locator

Connector Type	Page
Straight, PCB Mount	<a href="#">132</a>
<b>MMCX Jack Connectors</b>	
Right Angle, PCB Mount	<a href="#">132</a>
Straight, PCB Mount	<a href="#">132</a>
<b>MMCX Plug Connectors</b>	
Right Angle, Cable Connectors	<a href="#">132</a>
Straight, Cable Connectors	<a href="#">132</a>
Straight, PCB Mount	<a href="#">132</a>
<b>N Female Connectors</b>	
Right Angle, 4 Hole Flange, Terminal	<a href="#">137</a>
Right Angle, Bulkhead, PCB Mount	<a href="#">137</a>
Straight, 2 Hole Flange, Terminal	<a href="#">136</a>
Straight, 4 Hole Flange, Cable Connectors	<a href="#">136</a>
Straight, 4 Hole Flange, Terminal	<a href="#">136</a>
Straight, Bulkhead, Cable Connectors	<a href="#">135</a>
Straight, Bulkhead, PCB Mount	<a href="#">136</a>
Straight, Bulkhead, Terminal	<a href="#">136</a>
Straight, Cable Connectors	<a href="#">135</a>
Straight, PCB Mount	<a href="#">135</a>
Straight, Press-In, Terminal	<a href="#">137</a>
<b>N Male Connectors</b>	
Right Angle, Cable Connectors	<a href="#">134</a>
Straight, 4 Hole Flange, Terminal	<a href="#">134</a>
Straight, Bulkhead, Terminal	<a href="#">134</a>
Straight, Cable Connectors	<a href="#">133</a>
<b>QMA Female Connectors</b>	
Straight, Bulkhead, Cable Connectors	<a href="#">138</a>
Straight, Cable Connectors	<a href="#">138</a>
Straight, PCB Mount	<a href="#">138</a>
<b>QMA Male Connectors</b>	
Right Angle, Cable Connectors	<a href="#">138</a>
Straight, Cable Connectors	<a href="#">137</a>
<b>QN Female Connectors</b>	
Straight, Bulkhead, Cable Connectors	<a href="#">138</a>
<b>QN Male Connectors</b>	
Right Angle, Cable Connectors	<a href="#">138</a>
Straight, Cable Connectors	<a href="#">138</a>
<b>Reverse Polarity BNC Female Connectors</b>	
Straight, Bulkhead, Terminal	<a href="#">126</a>
<b>Reverse Polarity BNC Male Connectors</b>	
Right Angle, Cable Connectors	<a href="#">125</a>
Straight, Cable Connectors	<a href="#">125</a>
<b>Reverse Polarity MCX Jack Connectors</b>	
Right Angle, Bulkhead, PCB Mount	<a href="#">130</a>
<b>Reverse Polarity MCX Plug Connectors</b>	
Right Angle, Cable Connectors	<a href="#">130</a>
<b>Reverse Polarity N Male Connectors</b>	
Straight, Cable Connectors	<a href="#">137</a>
<b>Reverse Polarity SMA Female Connectors</b>	
Right Angle, Bulkhead, PCB Mount	<a href="#">145</a>
Right Angle, PCB Mount	<a href="#">145</a>

Connector Type	Page
Straight, 2 Hole Flange, Terminal	<a href="#">145</a>
Straight, Bulkhead, Cable Connectors	<a href="#">145</a>
Straight, Cable Connectors	<a href="#">145</a>
Straight, PCB Mount	<a href="#">145</a>
<b>Reverse Polarity SMA Male Connectors</b>	
Right Angle, Cable Connectors	<a href="#">144</a>
Straight, Cable Connectors	<a href="#">144</a>
<b>Reverse Polarity TNC Female Connectors</b>	
Straight, Bulkhead, Cable Connectors	<a href="#">155</a>
Straight, Cable Connectors	<a href="#">155</a>
<b>Reverse Polarity TNC Male Connectors</b>	
Right Angle, Cable Connectors	<a href="#">154</a>
Straight, 4 Hole Flange, Terminal	<a href="#">154</a>
Straight, Cable Connectors	<a href="#">154</a>
<b>Reverse Thread SMA Female Connectors</b>	
Straight, Bulkhead, Cable Connectors	<a href="#">145</a>
Straight, Cable Connectors	<a href="#">145</a>
Straight, PCB Mount	<a href="#">145</a>
<b>Reverse Thread SMA Male Connectors</b>	
Right Angle, Cable Connectors	<a href="#">145</a>
Straight, Cable Connectors	<a href="#">145</a>
<b>SC Female Connectors</b>	
Straight, 4 Hole Flange, Terminal	<a href="#">139</a>
Straight, Bulkhead, Terminal	<a href="#">139</a>
<b>SC Male Connectors</b>	
Right Angle, Cable Connectors	<a href="#">139</a>
Straight, Cable Connectors	<a href="#">139</a>
<b>SHV Jack Connectors</b>	
Straight, 4 Hole Flange, Terminal	<a href="#">139</a>
Straight, Bulkhead, Cable Connectors	<a href="#">139</a>
Straight, Bulkhead, Terminal	<a href="#">139</a>
<b>SHV Plug Connectors</b>	
Straight, Bulkhead, Terminal	<a href="#">139</a>
Straight, Cable Connectors	<a href="#">139</a>
<b>SMA Female Connectors</b>	
Right Angle, 2 Hole Flange, Terminal	<a href="#">144</a>
Right Angle, 4 Hole Flange, Field Replaceable Contact	<a href="#">144</a>
Right Angle, 4 Hole Flange, Terminal	<a href="#">144</a>
Right Angle, Bulkhead, PCB Mount	<a href="#">144</a>
Right Angle, PCB Mount	<a href="#">144</a>
Straight, 2 Hole Flange, Cable Connectors	<a href="#">143</a>
Straight, 2 Hole Flange, Field Replaceable Contact	<a href="#">143</a>
Straight, 2 Hole Flange, Terminal	<a href="#">143</a>
Straight, 4 Hole Flange, Cable Connectors	<a href="#">143</a>
Straight, 4 Hole Flange, Field Replaceable Contact	<a href="#">144</a>
Straight, 4 Hole Flange, Terminal	<a href="#">143</a>
Straight, Bulkhead, Cable Connectors	<a href="#">142</a>
Straight, Bulkhead, PCB Mount	<a href="#">143</a>
Straight, Bulkhead, Terminal	<a href="#">143</a>
Straight, Cable Connectors	<a href="#">142</a>
Straight, PCB Mount	<a href="#">142</a>

# Connector Locator

Connector Type	Page
Straight, Press-In, Terminal	<a href="#">144</a>
<b>SMA Male Connectors</b>	
Right Angle, Cable Connectors	<a href="#">141</a>
Right Angle, PCB Mount	<a href="#">141</a>
Straight, 2 Hole Flange, Field Replaceable Contact	<a href="#">141</a>
Straight, 2 Hole Flange, Terminal	<a href="#">141</a>
Straight, 4 Hole Flange, Terminal	<a href="#">141</a>
Straight, Bulkhead, Terminal	<a href="#">141</a>
Straight, Cable Connectors	<a href="#">140</a>
Straight, PCB Mount	<a href="#">140</a>
<b>SMB Jack Connectors</b>	
Right Angle, Bulkhead, PCB Mount	<a href="#">147</a>
Right Angle, PCB Mount	<a href="#">147</a>
Straight, 4 Hole Flange, Terminal	<a href="#">147</a>
Straight, Bulkhead, Cable Connectors	<a href="#">147</a>
Straight, Bulkhead, PCB Mount	<a href="#">147</a>
Straight, Bulkhead, Terminal	<a href="#">147</a>
Straight, Cable Connectors	<a href="#">146</a>
Straight, PCB Mount	<a href="#">146</a>
<b>SMB Plug Connectors</b>	
Right Angle, Cable Connectors	<a href="#">146</a>
Straight, Bulkhead, Terminal	<a href="#">146</a>
Straight, Cable Connectors	<a href="#">146</a>
Straight, PCB Mount	<a href="#">146</a>
<b>SMC Jack Connectors</b>	
Right Angle, Bulkhead, PCB Mount	<a href="#">148</a>
Right Angle, PCB Mount	<a href="#">148</a>
Straight, 4 Hole Flange, Terminal	<a href="#">148</a>
Straight, Bulkhead, Cable Connectors	<a href="#">147</a>
Straight, Bulkhead, PCB Mount	<a href="#">148</a>
Straight, Bulkhead, Terminal	<a href="#">148</a>
Straight, Cable Connectors	<a href="#">147</a>
Straight, PCB Mount	<a href="#">147</a>
<b>SMC Plug Connectors</b>	
Right Angle, Cable Connectors	<a href="#">147</a>
Right Angle, PCB Mount	<a href="#">147</a>
Straight, Cable Connectors	<a href="#">147</a>
<b>SMP Female Connectors</b>	
Right Angle, Cable Connectors	<a href="#">149</a>
Straight, Cable Connectors	<a href="#">149</a>
Straight, PCB Mount	<a href="#">149</a>
<b>SMP Male Connectors</b>	
Right Angle, PCB Mount	<a href="#">149</a>
Straight, 2 Hole Flange, Cable Connectors	<a href="#">148</a>
Straight, Bulkhead, Cable Connectors	<a href="#">148</a>
Straight, PCB Mount	<a href="#">148</a>
Straight, Solder, Terminal	<a href="#">149</a>
Straight, Terminal	<a href="#">148</a>
Straight, Thread-In, Cable Connectors	<a href="#">148</a>
Straight, Thread-In, Terminal	<a href="#">149</a>
<b>SSMA Female Connectors</b>	
Right Angle, PCB Mount	<a href="#">150</a>

Connector Type	Page
Straight, 2 Hole Flange, Cable Connectors	<a href="#">150</a>
Straight, 2 Hole Flange, Terminal	<a href="#">150</a>
Straight, 4 Hole Flange, Terminal	<a href="#">150</a>
Straight, Bulkhead, Cable Connectors	<a href="#">150</a>
Straight, Bulkhead, PCB Mount	<a href="#">150</a>
Straight, Bulkhead, Terminal	<a href="#">150</a>
Straight, Cable Connectors	<a href="#">150</a>
Straight, PCB Mount	<a href="#">150</a>
<b>SSMA Male Connectors</b>	
Right Angle, Cable Connectors	<a href="#">149</a>
Straight, Cable Connectors	<a href="#">149</a>
<b>SSMB Jack Connectors</b>	
Right Angle, PCB Mount	<a href="#">151</a>
Straight, 4 Hole Flange, Terminal	<a href="#">151</a>
Straight, Bulkhead, Cable Connectors	<a href="#">151</a>
Straight, PCB Mount	<a href="#">151</a>
<b>SSMB Plug Connectors</b>	
Right Angle, Cable Connectors	<a href="#">151</a>
Straight, Cable Connectors	<a href="#">151</a>
<b>SSMC Jack Connectors</b>	
Right Angle, Bulkhead, Cable Connectors	<a href="#">152</a>
Right Angle, Bulkhead, Terminal	<a href="#">152</a>
Right Angle, Cable Connectors	<a href="#">152</a>
Right Angle, PCB Mount	<a href="#">152</a>
Straight, 2 Hole Flange, Terminal	<a href="#">152</a>
Straight, 4 Hole Flange, Terminal	<a href="#">152</a>
Straight, Bulkhead, Cable Connectors	<a href="#">152</a>
Straight, Bulkhead, Terminal	<a href="#">152</a>
Straight, Cable Connectors	<a href="#">151</a>
Straight, PCB Mount	<a href="#">152</a>
<b>SSMC Plug Connectors</b>	
Right Angle, Cable Connectors	<a href="#">151</a>
Right Angle, PCB Mount	<a href="#">151</a>
Straight, Cable Connectors	<a href="#">151</a>
<b>TNC Female Connectors</b>	
Right Angle, Bulkhead, Terminal	<a href="#">154</a>
Straight, 4 Hole Flange, Terminal	<a href="#">154</a>
Straight, Bulkhead, Cable Connectors	<a href="#">154</a>
Straight, Bulkhead, Terminal	<a href="#">154</a>
Straight, Cable Connectors	<a href="#">153</a>
<b>TNC Male Connectors</b>	
Right Angle, Cable Connectors	<a href="#">153</a>
Straight, 4 Hole Flange, Terminal	<a href="#">153</a>
Straight, Cable Connectors	<a href="#">152</a>
<b>UHF Female Connectors</b>	
Straight, 4 Hole Flange, Terminal	<a href="#">156</a>
Straight, Bulkhead, Terminal	<a href="#">156</a>
Straight, Cable Connectors	<a href="#">155</a>
<b>UHF Male Connectors</b>	
Straight, Cable Connectors	<a href="#">155</a>
<b>UMCX Jack Connectors</b>	
Straight, PCB Mount	<a href="#">156</a>



Free Shipping Available  
via UPS Ground to  
USA & Canada







Technical  
Support  
(866) 727-8376

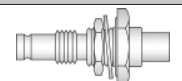

Same-Day Shipping,  
Even Custom  
Cable Assemblies

# 1.0/2.3 Connectors

Connection Method	Product Image	Attachment Cable/Contact	Coax Type / Termination Type	Model No.	Price				ROW
					1-24	25-49	50-99	100 +	
<b>Plug</b>									
Cable Connectors		Crimp/Solder	RG55, RG142, RG223, RG400	<a href="#">PE44242</a>	\$10.99	\$10.22	\$9.45	\$8.79	1
			RG174, RG316, RG188, LMR-100, PE-B100, PE-C100, .100 inch	<a href="#">PE44244</a>	\$12.61	\$11.73	\$10.84	\$10.09	2
<b>Plug Right Angle</b>									
Cable Connectors		Crimp/Solder	RG55, RG142, RG223, RG400	<a href="#">PE44247</a>	\$13.66	\$12.70	\$11.75	\$10.93	3
			RG174, RG316, RG188, LMR-100, PE-B100, PE-C100, .100 inch	<a href="#">PE44249</a>	\$14.24	\$13.24	\$12.25	\$11.39	4
<b>Jack</b>									
PCB Mount		Solder	Thru Hole with .200 inch x .055 inch Hole Spacing	<a href="#">PE44257</a>	\$8.76	\$8.15	\$7.53	\$7.01	5
<b>Jack, Bulkhead Mount</b>									
Cable Connectors		Solder/Solder	PE-SR405AL, PE-SR405FL, RG405 with .235 inch D Hole	<a href="#">PE44256</a>	\$16.57	\$15.41	\$14.25	\$13.26	6
PCB Mount		Solder	Thru Hole with .220 inch Diameter	<a href="#">PE44259</a>	\$12.12	\$11.27	\$10.42	\$9.70	7
<b>Jack Right Angle</b>									
PCB Mount		Solder	Thru Hole with .200 inch x .055 inch Hole Spacing	<a href="#">PE44258</a>	\$11.23	\$10.44	\$9.66	\$8.98	8

# 1.0mm Connectors

Connection Method	Product Image	Attachment Cable/Contact	Coax Type / Termination Type	Model No.	Price				ROW
					1-24	25-49	50-99	100 +	
<b>Female</b>									
PCB Mount		Clamp/Solder (Captive Contact)	End Launch	<a href="#">PE45403</a>	\$1,038.27	\$965.59	\$892.91	\$830.62	9

# 1.6/5.6 Connectors, [See Web](#) (9 parts available)

# 1.85mm Connectors

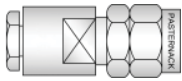
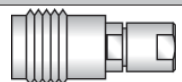
Connection Method	Product Image	Attachment Cable/Contact	Coax Type / Termination Type	Model No.	Price				ROW	
					1-24	25-49	50-99	100 +		
<b>Male</b>										
Cable Connectors		Clamp/Solder	PE-047SR, PE-SR047AL, PE-SR047FL	<a href="#">PE44335</a>	\$151.13	\$140.55	\$129.97	\$120.90	10	
			Solder	PE-047SR, PE-047SRAL, PE-047SRFL	<a href="#">PE45410</a>	\$89.31	\$83.06	\$76.81	\$71.45	11
				PE-SR405AL, RG405, PE-SR405FLJ	<a href="#">PE45413</a>	\$89.31	\$83.06	\$76.81	\$71.45	12
<b>Female</b>										
Cable Connectors		Clamp/Solder	PE-047SR, PE-SR047AL, PE-SR047FL	<a href="#">PE44800</a>	\$132.64	\$123.36	\$114.07	\$106.11	13	

\* Fits MIL-C-17 and equivalent cable versions only



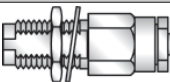

Connectors

See Our Website For Current Pricing & Real-Time Stock Availability!

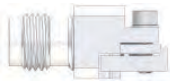

# 1.85mm Connectors

Connection Method	Product Image	Attachment Cable/Contact	Coax Type / Termination Type	Model No.	Price				ROW
					1-24	25-49	50-99	100 +	
PCB Mount		Clamp/Solder (Captive Contact)	End Launch	<a href="#">PE45402</a>	\$228.05	\$212.09	\$196.12	\$182.44	14
			End Launch	<a href="#">PE45477</a>	\$167.02	\$155.33	\$143.64	\$133.62	15
Cable Connectors	<b>Female, Bulkhead Mount</b>								
		Clamp/Solder	PE-SR405AL, PE-SR405FL, PE-SR405FLJ, PE-SR405TN, RG405 with .252 inch D Hole	<a href="#">PE44802</a>	\$125.53	\$116.74	\$107.96	\$100.42	16

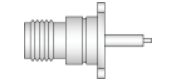
# 2.4mm Connectors

Connection Method	Product Image	Attachment Cable/Contact	Coax Type / Termination Type	Model No.	Price				ROW
					1-24	25-49	50-99	100 +	
<b>Male</b>									
PCB Mount		Clamp	Vertical Launch	<a href="#">PE45456</a>	\$45.82	\$42.61	\$39.41	\$36.66	17
			Vertical Launch	<a href="#">PE45457</a>	\$45.82	\$42.61	\$39.41	\$36.66	18
Cable Connectors		Clamp/Solder	PE-SR405AL, PE-SR405FL, PE-SR405FLJ, PE-SR405TN, RG405	<a href="#">PE44345</a>	\$82.14	\$76.39	\$70.64	\$65.71	19
			PE-SR405AL, PE-SR405FL, RG405	<a href="#">PE44215</a>	\$58.67	\$54.56	\$50.46	\$46.94	20
			PE-047SR, PE-047SRAL, PE-047SRFL	<a href="#">PE45411</a>	\$81.87	\$76.14	\$70.41	\$65.50	21
		Solder	PE-SR405AL, RG405, PE-SR405FLJ	<a href="#">PE45414</a>	\$81.87	\$76.14	\$70.41	\$65.50	22
<b>Female</b>									
PCB Mount		Clamp	Vertical Launch	<a href="#">PE45454</a>	\$42.83	\$39.83	\$36.83	\$34.26	23
			Vertical Launch	<a href="#">PE45455</a>	\$42.83	\$39.83	\$36.83	\$34.26	24
		Clamp/Solder (Captive Contact)	End Launch	<a href="#">PE45401</a>	\$169.85	\$157.96	\$146.07	\$135.88	25
			End Launch	<a href="#">PE45472</a>	\$90.98	\$84.61	\$78.24	\$72.78	26
			End Launch	<a href="#">PE45473</a>	\$90.98	\$84.61	\$78.24	\$72.78	27
			End Launch	<a href="#">PE45474</a>	\$90.98	\$84.61	\$78.24	\$72.78	28
			End Launch	<a href="#">PE45475</a>	\$90.98	\$84.61	\$78.24	\$72.78	29
End Launch	<a href="#">PE45476</a>	\$90.98	\$84.61	\$78.24	\$72.78	30			
Cable Connectors	<b>Female, Bulkhead Mount</b>								
		Clamp/Solder	PE-SR405AL, PE-SR405FL, PE-SR405FLJ, PE-SR405TN, RG405 with .252 inch D Hole	<a href="#">PE44801</a>	\$132.64	\$123.36	\$114.07	\$106.11	31
<b>Female, 2 Hole Flange Mount</b>									
Terminal		Solder	Pin with .481 inch Hole Spacing	<a href="#">PE44217</a>	\$156.37	\$145.42	\$134.48	\$125.10	32
<b>Female, 4 Hole Flange Mount</b>									
Terminal		Solder	Pin with .340 inch Hole Spacing	<a href="#">PE44218</a>	\$132.09	\$122.84	\$113.60	\$105.67	33
			Tab with .340 inch Hole Spacing	<a href="#">PE44226</a>	\$117.86	\$109.61	\$101.36	\$94.29	34

# 2.92mm Connectors

Connection Method	Product Image	Attachment Cable/Contact	Coax Type / Termination Type	Model No.	Price				ROW
					1-24	25-49	50-99	100 +	
<b>Male</b>									
PCB Mount		Clamp	Vertical Launch	<a href="#">PE45452</a>	\$42.70	\$39.71	\$36.72	\$34.16	35
			Vertical Launch	<a href="#">PE45453</a>	\$42.70	\$39.71	\$36.72	\$34.16	36
Cable Connectors		Clamp/Solder	PE-SR405AL, PE-SR405FL, PE-SR405FLJ, PE-SR405TN, RG405	<a href="#">PE44796</a>	\$64.85	\$60.31	\$55.77	\$51.88	37
			PE-SR047FL, PE-SR047AL, PE-047SR	<a href="#">PE44797</a>	\$107.22	\$99.71	\$92.21	\$85.78	38

\* Fits MIL-C-17 and equivalent cable versions only



Free Shipping Available via UPS Ground to USA & Canada



Technical Support (866) 727-8376











Same-Day Shipping, Even Custom Cable Assemblies

Connectors

See Our Website For Current Pricing & Real-Time Stock Availability!

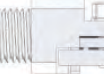

# 2.92mm Connectors

Connection Method	Product Image	Attachment Cable/Contact	Coax Type / Termination Type	Model No.	Price				ROW
					1-24	25-49	50-99	100 +	
<b>Male</b>									
Cable Connectors		Solder	PE-047SR, PE-047SRAL, PE-047SRFL	<a href="#">PE45412</a>	\$74.44	\$69.23	\$64.02	\$59.55	39
			PE-SR405AL, RG405, PE-SR405FLJ	<a href="#">PE45415</a>	\$74.44	\$69.23	\$64.02	\$59.55	40
			PE-SR402AL, PE-SR402FL, PE-SR402FLJ, PE-SR402TN, RG402	<a href="#">PE4987</a>	\$45.75	\$42.55	\$39.35	\$36.60	41
			PE-SR405AL, PE-SR405FL, RG405	<a href="#">PE4988</a>	\$46.93	\$43.64	\$40.36	\$37.54	42
			PE-118SR, .118 inch	<a href="#">PE4989</a>	\$64.75	\$60.22	\$55.69	\$51.80	43
<b>Male, 2 Hole Flange Mount</b>									
Terminal		Solder	Pin with .354 inch Hole Spacing	<a href="#">PE44347</a>	\$137.40	\$127.78	\$118.16	\$109.92	44
<b>Male, Threaded Mount</b>									
Field Replaceable		Field Replaceable	.012 inch Pin	<a href="#">PE44234</a>	\$90.70	\$84.35	\$78.00	\$72.56	45
<b>Female</b>									
PCB Mount		Clamp	Vertical Launch	<a href="#">PE45450</a>	\$39.90	\$37.11	\$34.31	\$31.92	46
			Vertical Launch	<a href="#">PE45451</a>	\$39.90	\$37.11	\$34.31	\$31.92	47
Cable Connectors		Clamp/Solder	PE-SR405AL, PE-SR405FL, PE-SR405FLJ, PE-SR405TN, RG405	<a href="#">PE44228</a>	\$111.24	\$103.45	\$95.67	\$88.99	48
			PE-047SR, PE-SR047AL, PE-SR047FL	<a href="#">PE44798</a>	\$121.89	\$113.36	\$104.83	\$97.51	49
PCB Mount		Clamp/Solder (Captive Contact)	End Launch	<a href="#">PE45400</a>	\$150.76	\$140.21	\$129.65	\$120.61	50
			End Launch	<a href="#">PE45467</a>	\$67.34	\$62.63	\$57.91	\$53.87	51
			End Launch	<a href="#">PE45468</a>	\$67.34	\$62.63	\$57.91	\$53.87	52
			End Launch	<a href="#">PE45469</a>	\$67.34	\$62.63	\$57.91	\$53.87	53
			End Launch	<a href="#">PE45470</a>	\$67.34	\$62.63	\$57.91	\$53.87	54
End Launch	<a href="#">PE45471</a>	\$67.34	\$62.63	\$57.91	\$53.87	55			
<b>Female, Bulkhead Mount</b>									
Cable Connectors		Clamp/Solder	PE-SR405AL, PE-SR405FL, PE-SR405FLJ, PE-SR405TN, RG405 with .235 inch D Hole	<a href="#">PE4992</a>	\$145.54	\$135.35	\$125.16	\$116.43	56
<b>Female, 2 Hole Flange Mount</b>									
Field Replaceable		Field Replaceable	.012 inch Pin with .481 inch Hole Spacing	<a href="#">PE44229</a>	\$120.13	\$111.72	\$103.31	\$96.10	57
<b>Female, 4 Hole Flange Mount</b>									
Field Replaceable		Field Replaceable	.012 inch Pin with .340 inch Hole Spacing	<a href="#">PE44230</a>	\$117.23	\$109.02	\$100.82	\$93.78	58
<b>Female, Threaded Mount</b>									
Field Replaceable		Field Replaceable	.012 inch Pin	<a href="#">PE44231</a>	\$97.06	\$90.27	\$83.47	\$77.65	59

# 3.5mm Connectors

Connection Method	Product Image	Attachment Cable/Contact	Coax Type / Termination Type	Model No.	Price				ROW
					1-24	25-49	50-99	100 +	
<b>Male</b>									
Cable Connectors		Threaded	VNA Test Cable	<a href="#">PE44487</a>	Call	Call	Call	Call	60
			PE-SR402AL, PE-SR402FL, PE-SR402FLJ, PE-SR402TN, RG402	<a href="#">PE4981</a>	\$88.18	\$82.01	\$75.83	\$70.54	61
			PE-SR405AL, PE-SR405FL, PE-SR405FLJ, PE-SR405TN, RG405	<a href="#">PE4982</a>	\$89.59	\$83.32	\$77.05	\$71.67	62

\* Fits MIL-C-17 and equivalent cable versions only

Connectors



See Our Website For Current Pricing & Real-Time Stock Availability!

# 3.5mm Connectors







Connection Method	Product Image	Attachment Cable/Contact	Coax Type / Termination Type	Model No.	Price				ROW
					1-24	25-49	50-99	100 +	
Cable Connectors	<b>Female, Bulkhead Mount</b>								
		Clamp/Solder	PE-SR402AL, PE-SR402FL, RG402 with .235 inch D Hole	<a href="#">PE4985</a>	\$262.57	\$244.19	\$225.81	\$210.06	63

# 3/4"-20 Twinax Connectors, [See Web](#) (4 parts available)

# 4.1/9.5 Mini DIN Connectors

Connection Method	Product Image	Attachment Cable/Contact	Coax Type / Termination Type	Model No.	Price				ROW
					1-24	25-49	50-99	100 +	
Cable Connectors	<b>Male</b>								
		Solder/Solder	SPP-250-LLPL	<a href="#">PE45421</a>	\$27.80	\$25.85	\$23.91	\$22.24	64
Cable Connectors	<b>Male Right Angle</b>								
		Solder/Solder	SPP-250-LLPL	<a href="#">PE45422</a>	\$38.22	\$35.54	\$32.87	\$30.58	65
Cable Connectors	<b>Female</b>								
		Solder/Solder	SPP-250-LLPL	<a href="#">PE45420</a>	\$31.26	\$29.07	\$26.88	\$25.01	66

# 4.3-10 Connectors

Connection Method	Product Image	Attachment Cable/Contact	Coax Type / Termination Type	Model No.	Price				ROW
					1-24	25-49	50-99	100 +	
Cable Connectors	<b>Male</b>								
		Crimp/Solder	LMR-400	<a href="#">TC-400-4310M-X</a>	Call	Call	Call	Call	67
			LMR-600	<a href="#">TC-600-4310M-X</a>	Call	Call	Call	Call	68
		Clamp/Solder	RG213, RG8, RG225, RG214, RG393	<a href="#">PE45295</a>	\$41.65	\$38.73	\$35.82	\$33.32	69
			RG213, RG8, RG225, RG214, RG393	<a href="#">PE45296</a>	\$66.39	\$61.74	\$57.10	\$53.11	70
		Solder/Solder	PE-1/4SFHC	<a href="#">PE45297</a>	\$39.36	\$36.60	\$33.85	\$31.49	71
			PE-1/4SFHC	<a href="#">PE45298</a>	\$17.30	\$16.09	\$14.88	\$13.84	72
			PE-1/2SFHC	<a href="#">PE45299</a>	\$17.54	\$16.31	\$15.08	\$14.03	73
			PE-1/2SFHC	<a href="#">PE45300</a>	\$29.63	\$27.56	\$25.48	\$23.70	74
			RG402, PE-SR402AL, PE-SR402FL, PE-SR402FLJ	<a href="#">PE45301</a>	\$29.15	\$27.11	\$25.07	\$23.32	75
			SPP-250-LLPL	<a href="#">PE45418</a>	\$27.80	\$25.85	\$23.91	\$22.24	76
		Crimp/Non-Solder Contact	LMR-240	<a href="#">EZ-240-4310M-X</a>	Call	Call	Call	Call	77
<b>Male Right Angle</b>									
Cable Connectors		Solder/Solder	PE-1/2SFHC	<a href="#">PE45302</a>	\$45.68	\$42.48	\$39.28	\$36.54	78
			RG402, PE-SR402AL, PE-SR402FL, PE-SR402FLJ	<a href="#">PE45303</a>	\$52.91	\$49.21	\$45.50	\$42.33	79
			SPP-250-LLPL	<a href="#">PE45419</a>	\$38.22	\$35.54	\$32.87	\$30.58	80
Cable Connectors	<b>Female</b>								
		Solder/Solder	SPP-250-LLPL	<a href="#">PE45417</a>	\$31.26	\$29.07	\$26.88	\$25.01	81

\* Fits MIL-C-17 and equivalent cable versions only



Free Shipping Available via UPS Ground to USA & Canada



Technical Support (866) 727-8376





Same-Day Shipping, Even Custom Cable Assemblies





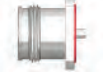





Connectors

See Our Website For Current Pricing & Real-Time Stock Availability!

# 4.3-10 Connectors

Connection Method	Product Image	Attachment Cable/Contact	Coax Type / Termination Type	Model No.	Price				ROW
					1-24	25-49	50-99	100 +	
<b>Female, 4 Hole Flange Mount</b>									
Cable Connectors		Solder/Solder	RG402, PE-SR402AL, PE-SR402FL, PE-SR402FLJ	<a href="#">PE45304</a>	\$25.13	\$23.37	\$21.61	\$20.10	82
Terminal		Solder	Solder Cup	<a href="#">PE45306</a>	\$18.52	\$17.22	\$15.93	\$14.82	83

# 7/16 DIN Connectors







Connection Method	Product Image	Attachment Cable/Contact	Coax Type / Termination Type	Model No.	Price				ROW	
					1-24	25-49	50-99	100 +		
<b>Male</b>										
Cable Connectors		Crimp/Solder	PE-C195, PE-P195, RG58, RG141, RG303, LMR-195, .195 inch	<a href="#">PE44536</a>	\$34.05	\$31.67	\$29.28	\$27.24	84	
			PE-C240, RG8X, .240 inch, LMR-240, LMR-240-DB, LMR-240-UF, B7808A	<a href="#">PE44994</a>	\$41.84	\$38.91	\$35.98	\$33.47	85	
			RG55, RG141, RG142, RG223, RG400	<a href="#">PE4568</a>	\$81.95	\$76.21	\$70.48	\$65.56	86	
			RG214, RG9, RG225, RG393	<a href="#">PE4571</a>	\$50.29	\$46.77	\$43.25	\$40.23	87	
		Clamp/Solder	RG14, RG217	<a href="#">PE44276</a>	\$136.18	\$126.65	\$117.11	\$108.94	88	
			RG17, RG218, RG219	<a href="#">PE44277</a>	\$148.00	\$137.64	\$127.28	\$118.40	89	
			PE-SR401AL, PE-SR401FL, RG401	<a href="#">PE44278</a>	\$40.12	\$37.31	\$34.50	\$32.10	90	
		Solder/Solder	SPP-250-LLPL	<a href="#">PE45424</a>	\$31.26	\$29.07	\$26.88	\$25.01	92	
			Clamp/Non-Solder Contact	1/2 inch Helical, 1/2 inch Superflexible, PE-1/2 Helical, PE-1/2SFHC	<a href="#">PE44732</a>	\$40.51	\$37.67	\$34.84	\$32.41	93
				1/2 inch Flexible, PE-1/2FAC	<a href="#">PE44738</a>	\$33.76	\$31.40	\$29.03	\$27.01	94
			Crimp/Non-Solder Contact	LMR-400, PE-C400, PE-B400, PE-B405	<a href="#">EZ-400-716M-X</a>	\$30.06	\$30.06	\$30.06	\$30.06	95
	LMR-600, PE-C600	<a href="#">EZ-600-716M-X</a>		\$33.62	\$33.62	\$33.62	\$33.62	96		
	PE-C400, PE-B400, PE-B405, LMR-400, LMR-400-DB, LMR-400-UF, .400 inch	<a href="#">PE44538</a>		\$61.43	\$57.13	\$52.83	\$49.14	97		
<b>Male Right Angle</b>										
Cable Connectors		Clamp/Solder	RG213, RG214, RG8, RG9, RG225, RG393, RG215	<a href="#">PE44280</a>	\$118.26	\$109.98	\$101.70	\$94.61	98	
			RG14, RG217	<a href="#">PE44282</a>	\$197.72	\$183.88	\$170.04	\$158.18	99	
		Solder/Solder	SPP-250-LLPL	<a href="#">PE45425</a>	\$45.15	\$41.99	\$38.83	\$36.12	1	
	Clamp/Non-Solder Contact	1/2 inch Helical	<a href="#">PE44979</a>	\$33.08	\$30.76	\$28.45	\$26.46	2		
<b>Female</b>										
Cable Connectors		Crimp/Solder	RG213, RG8	<a href="#">PE44284</a>	\$111.84	\$104.01	\$96.18	\$89.47	3	
			RG214, RG9, RG225, RG393	<a href="#">PE4575</a>	\$137.40	\$127.78	\$118.16	\$109.92	4	
		Clamp/Solder	RG213, RG55, RG141, RG142, RG223, RG400, RG303, PE-C195, PE-P195, LMR-195	<a href="#">PE44283</a>	\$136.02	\$126.50	\$116.98	\$108.82	5	
			RG14, RG217	<a href="#">PE44288</a>	\$135.90	\$126.39	\$116.87	\$108.72	6	
		Solder/Solder	SPP-250-LLPL	<a href="#">PE45423</a>	\$31.26	\$29.07	\$26.88	\$25.01	7	

\* Fits MIL-C-17 and equivalent cable versions only

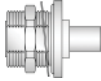
Connectors





See Our Website For Current Pricing & Real-Time Stock Availability!

# 7/16 DIN Connectors

Connection Method	Product Image	Attachment Cable/Contact	Coax Type / Termination Type	Model No.	Price				ROW
					1-24	25-49	50-99	100 +	
<b>Female, Bulkhead Mount</b>									
Cable Connectors		Crimp/Solder	.400 inch, LMR-400, LMR-400-DB, LMR-400-UF, PE-B405, PE-C400, PE-B400 with 1.161 inch DD Hole	<a href="#">PE44550</a>	\$77.35	\$71.94	\$66.52	\$61.88	8
			PE-C600, LMR-600, LMR-600-DB, .600 inch with 1.161 inch DD Hole	<a href="#">PE44551</a>	\$94.16	\$87.57	\$80.98	\$75.33	9
			RG55, RG142, RG223, RG400 with 1.161 inch DD Hole	<a href="#">PE44656</a>	\$64.80	\$60.26	\$55.73	\$51.84	10
Terminal		Solder	Solder Cup	<a href="#">PE4572</a>	\$164.73	\$153.20	\$141.67	\$131.78	11
<b>Female, 4 Hole Flange Mount</b>									
Cable Connectors		Clamp/Solder	RG214, RG213, RG393, RG8, RG225, RG215, RG9 with .975 inch Hole Spacing	<a href="#">PE44291</a>	\$160.20	\$148.99	\$137.77	\$128.16	12
Terminal		Solder	Stub	<a href="#">PE45000</a>	\$52.38	\$48.71	\$45.05	\$41.90	13
			Solder Cup with .975 inch Hole Spacing	<a href="#">PE4573</a>	\$90.83	\$84.47	\$78.11	\$72.66	14
		Field Replaceable	Slotted Contact	<a href="#">PE44717</a>	\$119.83	\$111.44	\$103.05	\$95.86	15
			Pin with .975 inch Hole Spacing	<a href="#">PE4574</a>	\$84.94	\$78.99	\$73.05	\$67.95	16
		Threaded Pin	Pin with .975 inch Hole Spacing	<a href="#">PE4574A</a>	\$33.38	\$31.04	\$28.71	\$26.70	17

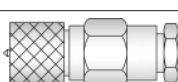
## 7mm Connectors, [See Web](#) (1 parts available)

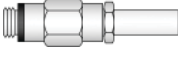
# 10-32 Connectors

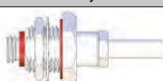
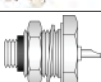
Connection Method	Product Image	Attachment Cable/Contact	Coax Type / Termination Type	Model No.	Price				ROW
					1-24	25-49	50-99	100 +	
<b>Male</b>									
Cable Connectors		Crimp/Solder	RG174, RG316, RG188, LMR-100, PE-B100, PE-C100, .100 inch	<a href="#">PE44351</a>	\$21.52	\$20.01	\$18.51	\$17.22	18
			RG178, RG196	<a href="#">PE44352</a>	\$33.61	\$31.26	\$28.90	\$26.89	19
			RG188-DS, RG316-DS	<a href="#">PE45170</a>	\$21.75	\$20.23	\$18.71	\$17.40	20
		Clamp/Solder	RG174, RG316, RG188, PE-B100, PE-C100, .100 inch, LMR-100	<a href="#">PE44353</a>	\$33.18	\$30.86	\$28.53	\$26.54	21
RG178, RG196			<a href="#">PE44354</a>	\$32.57	\$30.29	\$28.01	\$26.06	22	
<b>Male Right Angle</b>									
Cable Connectors		Crimp/Solder	RG174, RG316, RG188, PE-B100, PE-C100, .100 inch, LMR-100	<a href="#">PE44355</a>	\$24.86	\$23.12	\$21.38	\$19.89	23
			RG178, RG196	<a href="#">PE44356</a>	\$36.56	\$34.00	\$31.44	\$29.25	24
			RG316-DS, RG188-DS	<a href="#">PE45032</a>	\$23.15	\$21.53	\$19.91	\$18.52	25
<b>Female</b>									
Cable Connectors		Crimp/Solder	RG178, RG196	<a href="#">PE44362</a>	\$26.31	\$24.47	\$22.63	\$21.05	26
PCB Mount		Solder	Thru Hole with .200 inch x .067 inch Hole Spacing	<a href="#">PE44359</a>	\$22.69	\$21.10	\$19.51	\$18.15	27
<b>Female, Bulkhead Mount</b>									
Cable Connectors		Crimp/Solder	RG178, RG196 with .295 inch D Hole	<a href="#">PE44366</a>	\$30.17	\$28.06	\$25.95	\$24.14	28
Terminal		Solder	Solder Cup with .177 inch D Hole	<a href="#">PE44357</a>	\$24.11	\$22.42	\$20.73	\$19.29	29

\* Fits MIL-C-17 and equivalent cable versions only



Free Shipping Available via UPS Ground to USA & Canada



Technical Support (866) 727-8376



Same-Day Shipping, Even Custom Cable Assemblies







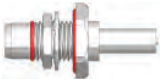

Connectors

See Our Website For Current Pricing & Real-Time Stock Availability!

# 10-32 Connectors

Connection Method	Product Image	Attachment Cable/Contact	Coax Type / Termination Type	Model No.	Price				ROW
					1-24	25-49	50-99	100 +	
PCB Mount	<b>Female Right Angle</b>								
		Solder	Thru Hole with .200 inch x .067 inch Hole Spacing	<a href="#">PE44360</a>	\$27.75	\$25.81	\$23.87	\$22.20	30

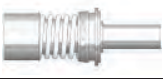
# BMA Connectors







Connection Method	Product Image	Attachment Cable/Contact	Coax Type / Termination Type	Model No.	Price				ROW		
					1-24	25-49	50-99	100 +			
PCB Mount	<b>Plug</b>										
		Solder	Thru Hole	<a href="#">PE45335</a>	\$58.77	\$54.66	\$50.54	\$47.02	31		
Cable Connectors		Crimp/Solder	Thru Hole	<a href="#">PE45336</a>	\$31.59	\$29.38	\$27.17	\$25.27	32		
			<b>Plug, Bulkhead Mount</b>								
			RG178, RG196	<a href="#">PE45315</a>	\$73.70	\$68.54	\$63.38	\$58.96	33		
			RG316, RG188, RG174, PE-C100, LMR-100A	<a href="#">PE45316</a>	\$45.00	\$41.85	\$38.70	\$36.00	34		
			RG188-DS, RG316-DS	<a href="#">PE45317</a>	\$33.11	\$30.79	\$28.47	\$26.49	35		
	RG142, RG223, RG400, RG55	<a href="#">PE45318</a>	\$32.19	\$29.94	\$27.68	\$25.75	36				
		Solder/Non-Solder Contact	RG405, PE-SR405AL, PE-SR405FL, PE-SR405FLJ, PE-SR405TN	<a href="#">PE45310</a>	\$34.51	\$32.09	\$29.68	\$27.61	37		
			RG405, PE-SR405AL, PE-SR405FL, PE-SR405FLJ, PE-SR405TN	<a href="#">PE45311</a>	\$23.83	\$22.16	\$20.49	\$19.06	38		
			RG402, PE-SR402AL, PE-SR402FL, PE-SR402FLJ, PE-SR402TN	<a href="#">PE45313</a>	\$54.57	\$50.75	\$46.93	\$43.66	39		
			RG402, PE-SR402AL, PE-SR402FL, PE-SR402FLJ, PE-SR402TN	<a href="#">PE45314</a>	\$22.99	\$21.38	\$19.77	\$18.39	40		
<b>Plug, 2 Hole Flange Mount</b>											
Terminal		Solder	Stub with .481 inch Hole Spacing	<a href="#">PE45341</a>	\$30.32	\$28.20	\$26.08	\$24.26	41		
			Stub with .481 inch Hole Spacing	<a href="#">PE45342</a>	\$33.53	\$31.18	\$28.84	\$26.82	42		
			Stub with .481 inch Hole Spacing	<a href="#">PE45343</a>	\$10.75	\$10.00	\$9.25	\$8.60	43		
			Stub with .481 inch Hole Spacing	<a href="#">PE45344</a>	\$15.04	\$13.99	\$12.93	\$12.03	44		
			Stub with .481 inch Hole Spacing	<a href="#">PE45347</a>	\$64.46	\$59.95	\$55.44	\$51.57	45		
Field Replaceable		Field Replaceable	.012 inch Pin with .481 inch Hole Spacing	<a href="#">PE45345</a>	\$217.85	\$202.60	\$187.35	\$174.28	46		
			.020 inch Pin with .481 inch Hole Spacing	<a href="#">PE45346</a>	\$208.05	\$193.49	\$178.92	\$166.44	47		
			.036 inch Pin with .481 inch Hole Spacing	<a href="#">PE45348</a>	\$68.31	\$63.53	\$58.75	\$54.65	48		
<b>Plug, 4 Hole Flange Mount</b>											
Terminal		Solder	Stub with .340 inch Hole Spacing	<a href="#">PE45339</a>	\$34.04	\$31.66	\$29.27	\$27.23	49		
<b>Plug, Thread-In</b>											
Terminal		None	Pin	<a href="#">PE45350</a>	\$100.90	\$93.84	\$86.77	\$80.72	50		
			Pin	<a href="#">PE45351</a>	\$60.63	\$56.39	\$52.14	\$48.50	51		
			Pin	<a href="#">PE45352</a>	\$115.25	\$107.18	\$99.12	\$92.20	52		
			Pin	<a href="#">PE45353</a>	\$133.78	\$124.42	\$115.05	\$107.02	53		
<b>Plug Right Angle</b>											
PCB Mount		Solder	Surface Mount	<a href="#">PE45333</a>	\$133.97	\$124.59	\$115.21	\$107.18	54		
			Thru Hole	<a href="#">PE45355</a>	\$36.27	\$33.73	\$31.19	\$29.02	55		
<b>Jack</b>											
Cable Connectors		Crimp/Solder	RG316, RG188, RG174, PE-C100, LMR-100A	<a href="#">PE45319</a>	\$73.81	\$68.64	\$63.48	\$59.05	56		
			RG142, RG223, RG400, RG55	<a href="#">PE45320</a>	\$98.08	\$91.21	\$84.35	\$78.46	57		
		Solder/Solder	RG405, PE-SR405AL, PE-SR405FL, PE-SR405FLJ	<a href="#">PE45324</a>	\$65.51	\$60.92	\$56.34	\$52.41	58		
			RG405, PE-SR405AL, PE-SR405FL, PE-SR405FLJ	<a href="#">PE45325</a>	\$93.19	\$86.67	\$80.14	\$74.55	59		
		Solder/Non-Solder Contact	RG402, PE-SR402AL, PE-SR402FL, PE-SR402FLJ, PE-SR402TN	<a href="#">PE45328</a>	\$76.04	\$70.72	\$65.39	\$60.83	60		

\* Fits MIL-C-17 and equivalent cable versions only

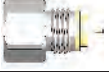
Connectors

See Our Website For Current Pricing & Real-Time Stock Availability!

# BMA Connectors

Connection Method	Product Image	Attachment Cable/Contact	Coax Type / Termination Type	Model No.	Price				ROW
					1-24	25-49	50-99	100 +	
PCB Mount		Solder	Thru Hole	<a href="#">PE45337</a>	\$48.95	\$45.52	\$42.10	\$39.16	61
			Surface Mount	<a href="#">PE45338</a>	\$56.90	\$52.92	\$48.93	\$45.52	62
Terminal			Stub	<a href="#">PE45349</a>	\$185.40	\$172.42	\$159.44	\$148.32	63
<b>Jack, Bulkhead Mount</b>									
Cable Connectors		Solder/Solder	RG405, PE-SR405AL, PE-SR405FL, PE-SR405FLJ	<a href="#">PE45323</a>	\$42.10	\$39.15	\$36.21	\$33.68	64
<b>Jack, 2 Hole Flange Mount</b>									
Cable Connectors		Crimp/Solder	RG316, RG188, RG174, LMR-100A, PE-C100-LSZH	<a href="#">PE45321</a>	\$40.76	\$37.91	\$35.05	\$32.61	65
		Solder/Solder	RG402, PE-SR402AL, PE-SR402FL, PE-SR402FLJ, PE-SR402TN	<a href="#">PE45326</a>	\$54.51	\$50.69	\$46.88	\$43.61	66
			RG402, PE-SR402AL, PE-SR402FL, PE-SR402FLJ, PE-SR402TN	<a href="#">PE45327</a>	\$36.47	\$33.92	\$31.36	\$29.18	67
		Solder/Non-Solder Contact	RG405, PE-SR405AL, PE-SR405FL, PE-SR405FLJ	<a href="#">PE45322</a>	\$47.63	\$44.30	\$40.96	\$38.10	68
Terminal		Solder	Stub	<a href="#">PE45340</a>	\$58.87	\$54.75	\$50.63	\$47.10	69
<b>Jack, 4 Hole Flange Mount</b>									
Terminal		Solder	Stub with .340 inch Hole Spacing	<a href="#">PE45334</a>	\$52.20	\$48.55	\$44.89	\$41.76	70
<b>Jack, Thread-In</b>									
Terminal		None	Pin	<a href="#">PE45354</a>	\$60.77	\$56.52	\$52.26	\$48.62	71
<b>Jack Right Angle, 2 Hole Flange Mount</b>									
Cable Connectors		Crimp/Solder	RG142, RG223, RG400, RG55	<a href="#">PE45332</a>	\$53.47	\$49.73	\$45.98	\$42.78	72
		Solder/Solder	RG402, PE-SR402AL, PE-SR402FL, PE-SR402FLJ, PE-SR402TN	<a href="#">PE45329</a>	\$64.43	\$59.92	\$55.41	\$51.54	73
			RG405, PE-SR405AL, PE-SR405FL, PE-SR405FLJ	<a href="#">PE45330</a>	\$74.29	\$69.09	\$63.89	\$59.43	74
			RG405, PE-SR405AL, PE-SR405FL, PE-SR405FLJ	<a href="#">PE45331</a>	\$59.08	\$54.94	\$50.81	\$47.26	75

# BNC Connectors

Connection Method	Product Image	Attachment Cable/Contact	Coax Type / Termination Type	Model No.	Price				ROW		
					1-24	25-49	50-99	100 +			
<b>Male</b>											
Cable Connectors		Crimp/Crimp	RG58, RG303, RG141, PE-C195, PE-P195, LMR-195, .195 inch	<a href="#">PE4016</a>	\$6.78	\$6.31	\$5.83	\$5.42	76		
			RG59*, RG62*, RG71	<a href="#">PE4018</a>	\$8.23	\$7.65	\$7.08	\$6.58	77		
			.100 inch, RG316, RG174, RG188, LMR-100, LMR-100, LMR-100-FR, PE-C100, PE-B100	<a href="#">PE45045</a>	\$7.03	\$6.54	\$6.05	\$5.62	78		
				Crimp/Solder	RG316-DS, RG188-DS	<a href="#">PE45114</a>	\$6.77	\$6.30	\$5.82	\$5.42	79
					RG55, RG141, RG142, RG223, RG400	<a href="#">PE4044</a>	\$7.30	\$6.79	\$6.28	\$5.84	80
					PE-B150, RG180, RG195	<a href="#">PE4247</a>	\$12.57	\$11.69	\$10.81	\$10.06	81
					RG214, RG9, RG225, RG393	<a href="#">PE4351</a>	\$21.24	\$19.75	\$18.27	\$16.99	82
					RG213, RG215, RG8	<a href="#">PE4378</a>	\$23.64	\$21.99	\$20.33	\$18.91	83
					RG58 Plenum, RG122, RG58-P	<a href="#">PE4381</a>	\$15.92	\$14.81	\$13.69	\$12.74	84
					RG59* Plenum, RG59*-P, RG302	<a href="#">PE4382</a>	\$16.57	\$15.41	\$14.25	\$13.26	85
					PE-C400, LMR-400	<a href="#">PE44294</a>	\$27.46	\$25.54	\$23.62	\$21.97	86
					PE-C240, RG8X, .240 inch, LMR-240, LMR-240-DB, LMR-240-UF, B7808A	<a href="#">PE44640</a>	\$13.96	\$12.98	\$12.01	\$11.17	87

\* Fits MIL-C-17 and equivalent cable versions only



Free Shipping Available via UPS Ground to USA & Canada



Technical Support (866) 727-8376









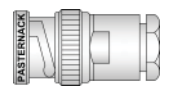
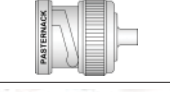

Same-Day Shipping, Even Custom Cable Assemblies

Connectors

See Our Website For Current Pricing & Real-Time Stock Availability!

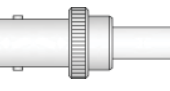
# BNC Connectors







Connection Method	Product Image	Attachment Cable/Contact	Coax Type / Termination Type	Model No.	Price				ROW	
					1-24	25-49	50-99	100 +		
Cable Connectors	<b>Male</b>									
		Crimp/Solder	RG178, RG196	<a href="#">PE4643</a>	\$22.12	\$20.57	\$19.02	\$17.70	88	
			LMR-200, PE-C200	<a href="#">TC-200-BM-X</a>	\$14.27	\$14.27	\$14.27	\$14.27	89	
			LMR-240, PE-C240	<a href="#">TC-240-BM-X</a>	\$12.51	\$12.51	\$12.51	\$12.51	90	
			LMR-400, PE-C400	<a href="#">TC-400-BM</a>	\$13.87	\$13.87	\$13.87	\$13.87	91	
		Clamp/Solder	RG58, RG55, RG141, RG142, RG223, RG400, RG303, PE-C195, PE-P195, LMR-195	<a href="#">PE4023</a>	\$6.89	\$6.41	\$5.93	\$5.51	92	
			RG59*, RG62*, RG71	<a href="#">PE4024</a>	\$8.84	\$8.22	\$7.60	\$7.07	93	
			RG174, RG316, RG188, .100 inch, PE-B100, PE-C100, LMR-100	<a href="#">PE4084</a>	\$12.07	\$11.23	\$10.38	\$9.66	94	
			RG8, RG215, RG225, RG214, RG393, RG213	<a href="#">PE4109</a>	\$15.92	\$14.81	\$13.69	\$12.74	95	
			PE-SR402AL, PE-SR402FL, RG402	<a href="#">PE4206</a>	\$18.63	\$17.33	\$16.02	\$14.90	96	
			RG8X, PE-C240, .240 inch, B7808A, LMR-240	<a href="#">PE4379</a>	\$17.31	\$16.10	\$14.89	\$13.85	97	
			RG178, RG196	<a href="#">PE4384</a>	\$15.72	\$14.62	\$13.52	\$12.58	98	
			PE-B400, PE-B405, PE-C400, LMR-400, .400 inch	<a href="#">PE4386</a>	\$26.16	\$24.33	\$22.50	\$20.93	99	
			LMR-240, PE-C240	<a href="#">TC-240-BMC</a>	\$16.68	\$16.68	\$16.68	\$16.68	1	
				Solder/Solder	PE-SR402AL, PE-SR402FL, PE-SR402FLJ, PE-SR402TN, RG402	<a href="#">PE4650</a>	\$24.11	\$22.42	\$20.73	\$19.29
	PE-SR405AL, PE-SR405FL, RG405	<a href="#">PE4651</a>			\$24.11	\$22.42	\$20.73	\$19.29	3	
	PE-047SR, PE-SR047AL, PE-SR047FL	<a href="#">PE4974</a>			\$34.43	\$32.02	\$29.61	\$27.54	4	
		Crimp/Non-Solder Contact	LMR-400, PE-C400, LMR-400-DB	<a href="#">EZ-400-BM-X</a>	\$27.42	\$27.42	\$27.42	\$27.42	5	
	Terminal	<b>Male, Bulkhead Mount</b>								
			Solder	Solder Cup with .350 inch D Hole	<a href="#">PE4211</a>	\$14.43	\$13.42	\$12.41	\$11.54	6
Terminal	<b>Male, 4 Hole Flange Mount</b>									
		Solder	Solder Cup with .531 inch Hole Spacing	<a href="#">PE4082</a>	\$15.68	\$14.58	\$13.48	\$12.54	7	
Cable Connectors	<b>Male Right Angle</b>									
		Crimp/Crimp	RG58, RG303, RG141, PE-C195, PE-P195, LMR-195, .195 inch	<a href="#">PE4298</a>	\$24.67	\$22.94	\$21.22	\$19.74	8	
			RG55, RG141, RG142, RG223, RG400	<a href="#">PE4345</a>	\$10.95	\$10.18	\$9.42	\$8.76	9	
		Crimp/Solder	RG174, RG316, RG188, .100 inch, PE-B100, PE-C100, LMR-100	<a href="#">PE4393</a>	\$24.20	\$22.51	\$20.81	\$19.36	10	
			PE-C240, RG8X, .240 inch, LMR-240, LMR-240-DB, LMR-240-UF, B7808A	<a href="#">PE44641</a>	\$24.76	\$23.03	\$21.29	\$19.81	11	
		Clamp/Solder	RG58, RG55, RG141, RG142, RG223, RG400, RG303, PE-C195, PE-P195, LMR-195	<a href="#">PE4053</a>	\$17.61	\$16.38	\$15.14	\$14.09	12	
RG174, RG316, RG188, .100 inch, PE-B100, PE-C100, LMR-100			<a href="#">PE4307</a>	\$49.52	\$46.05	\$42.59	\$39.62	13		
RG213, RG214, RG8, RG9, RG11*, RG225, RG393, RG144*, RG216*, RG215			<a href="#">PE4387</a>	\$33.53	\$31.18	\$28.84	\$26.82	14		
RG178, RG196	<a href="#">PE4388</a>	\$21.77	\$20.25	\$18.72	\$17.42	15				
Cable Connectors	<b>Female</b>									
		Crimp/Solder	PE-C195, PE-P195, RG58, RG141, RG303, LMR-195, .195 inch	<a href="#">PE4070</a>	\$8.91	\$8.29	\$7.66	\$7.13	16	
			RG174, RG316, RG188, LMR-100, PE-B100, PE-C100, .100 inch	<a href="#">PE4079</a>	\$13.88	\$12.91	\$11.94	\$11.10	17	
			RG55, RG141, RG142, RG223, RG400	<a href="#">PE4397</a>	\$9.59	\$8.92	\$8.25	\$7.67	18	
			PE-C240, RG8X, .240 inch, LMR-240, LMR-240-DB, LMR-240-UF, B7808A	<a href="#">PE44642</a>	\$8.06	\$7.50	\$6.93	\$6.45	19	
		Clamp/Solder	RG58, RG55, RG141, RG142, RG223, RG400, RG303, PE-C195, PE-P195, LMR-195	<a href="#">PE4058</a>	\$9.34	\$8.69	\$8.03	\$7.47	20	
			RG213, RG214, RG8, RG9, RG11*, RG225, RG393, RG144*, RG216*, RG215	<a href="#">PE4212</a>	\$41.43	\$38.53	\$35.63	\$33.14	21	
			RG174, RG316, RG188	<a href="#">PE4321</a>	\$12.86	\$11.96	\$11.06	\$10.29	22	
RG178, RG196			<a href="#">PE4389</a>	\$17.42	\$16.20	\$14.98	\$13.94	23		

\* Fits MIL-C-17 and equivalent cable versions only

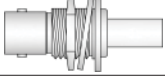
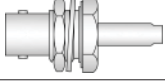
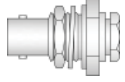
Connectors

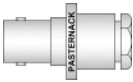
See Our Website For Current Pricing & Real-Time Stock Availability!





# BNC Connectors

Connection Method	Product Image	Attachment Cable/Contact	Coax Type / Termination Type	Model No.	Price				ROW
					1-24	25-49	50-99	100 +	
<b>Female, Bulkhead Mount</b>									
Cable Connectors		Crimp/Crimp	RG58, PE-C195, PE-P195, LMR-195	<a href="#">PE45064</a>	\$11.27	\$10.48	\$9.69	\$9.02	24
		Crimp/Solder	RG174, RG316, RG188, LMR-100, PE-B100, PE-C100, .100 inch with .480 inch D Hole	<a href="#">PE4106</a>	\$15.54	\$14.45	\$13.36	\$12.43	25
			RG55, RG142, RG223, RG400, RG141 with .480 inch D Hole	<a href="#">PE4209</a>	\$18.53	\$17.23	\$15.94	\$14.82	26
			RG188-DS, RG316-DS with .480 inch D Hole	<a href="#">PE4392</a>	\$17.42	\$16.20	\$14.98	\$13.94	27
		Clamp/Solder	RG58, RG142, RG223, RG400, RG141, RG303, RG55, LMR-400, PE-C195, PE-P195 with .480 inch D Hole	<a href="#">PE4078</a>	\$16.37	\$15.22	\$14.08	\$13.10	28
			RG174, RG316, RG188 with .480 inch D Hole	<a href="#">PE4319</a>	\$15.72	\$14.62	\$13.52	\$12.58	29
			RG178, RG196 with .480 inch D Hole	<a href="#">PE4391</a>	\$18.93	\$17.60	\$16.28	\$15.14	30
			RG214, RG213, RG393, RG8, RG225, RG11*, RG216*, RG144*, RG215, RG9 with .480 inch D Hole	<a href="#">PE4632</a>	\$45.99	\$42.77	\$39.55	\$36.79	31
			PE-SR402AL, PE-SR402FL, RG402	<a href="#">PE4915</a>	\$30.57	\$28.43	\$26.29	\$24.46	32
	Terminal		Solder	Solder Cup with .410 inch D Hole	<a href="#">PE4014</a>	\$6.59	\$6.13	\$5.67	\$5.27
Solder Cup with .350 inch D Hole				<a href="#">PE4015</a>	\$6.13	\$5.70	\$5.27	\$4.90	34
Turret with .480 inch D Hole				<a href="#">PE4049</a>	\$16.43	\$15.28	\$14.13	\$13.14	35
Spade with .350 inch D Hole				<a href="#">PE4077</a>	\$16.61	\$15.45	\$14.28	\$13.29	36
Solder Cup with .350 inch D Hole				<a href="#">PE4091</a>	\$8.87	\$8.25	\$7.63	\$7.10	37
Solder Cup with .480 inch D Hole				<a href="#">PE4318</a>	\$16.00	\$14.88	\$13.76	\$12.80	38
Eyelet				<a href="#">PE44890</a>	\$26.38	\$24.53	\$22.69	\$21.10	39
<b>Female, 4 Hole Flange Mount</b>									
Cable Connectors		Clamp/Solder	RG58, RG142, RG223, RG400, RG141, RG303, RG55 LMR-400, PE-C195, PE-P195 with .500 inch Threaded Hole Spacing	<a href="#">PE4056</a>	\$16.31	\$15.17	\$14.03	\$13.05	40
Terminal		Solder	Solder Cup with .500 inch Threaded Hole Spacing	<a href="#">PE4010</a>	\$8.71	\$8.10	\$7.49	\$6.97	41
			Turret with .531 inch Hole Spacing	<a href="#">PE4011</a>	\$18.66	\$17.35	\$16.05	\$14.93	42
<b>Female Right Angle, Bulkhead Mount</b>									
Terminal		Solder	Solder Cup with .361 inch D Hole	<a href="#">PE4055</a>	\$24.50	\$22.79	\$21.07	\$19.60	43
<b>Female Right Angle, 4 Hole Flange Mount</b>									
Terminal		Solder	Solder Cup with .531 inch Hole Spacing	<a href="#">PE4317</a>	\$28.67	\$26.66	\$24.66	\$22.94	44

Connectors

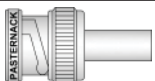
See Our Website For Current Pricing & Real-Time Stock Availability!

# Reverse Polarity BNC Connectors

Connection Method	Product Image	Attachment Cable/Contact	Coax Type / Termination Type	Model No.	Price				ROW
					1-24	25-49	50-99	100 +	
<b>Male</b>									
Cable Connectors		Crimp/Solder	RG55, RG141, RG142, RG223, RG400	<a href="#">PE4715</a>	\$13.78	\$12.82	\$11.85	\$11.02	45
			RG59*, RG62*	<a href="#">PE4718</a>	\$15.06	\$14.01	\$12.95	\$12.05	46
			RG174, RG316, RG188, LMR-100, PE-B100, PE-C100, .100 inch	<a href="#">PE4720</a>	\$22.56	\$20.98	\$19.40	\$18.05	47
		Clamp/Solder	RG58, RG55, RG141, RG142, RG223, RG400, RG303, PE-C195, PE-P195, LMR-195	<a href="#">PE4714</a>	\$32.29	\$30.03	\$27.77	\$25.83	48
<b>Male Right Angle</b>									
Cable Connectors		Crimp/Solder	RG58, RG303, RG141, PE-C195, PE-P195, LMR-195, .195 inch	<a href="#">PE4730</a>	\$27.69	\$25.75	\$23.81	\$22.15	49
			RG174, RG316, RG188	<a href="#">PE4733</a>	\$22.56	\$20.98	\$19.40	\$18.05	50
			Clamp/Solder	RG58, RG55, RG141, RG142, RG223, RG400, RG303, PE-C195, PE-P195, LMR-195	<a href="#">PE4728</a>	\$23.30	\$21.67	\$20.04	\$18.64

\* Fits MIL-C-17 and equivalent cable versions only



Free Shipping Available via UPS Ground to USA & Canada



Technical Support (866) 727-8376



Same-Day Shipping, Even Custom Cable Assemblies





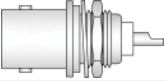

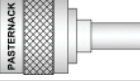
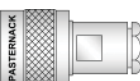

# Reverse Polarity BNC Connectors

Connection Method	Product Image	Attachment Cable/Contact	Coax Type / Termination Type	Model No.	Price				ROW
					1-24	25-49	50-99	100 +	
<b>Female, Bulkhead Mount</b>									
Terminal		Solder	Solder Cup with .410 inch D Hole	<a href="#">PE4757</a>	\$15.50	\$14.42	\$13.33	\$12.40	52
			Solder Cup with .480 inch D Hole	<a href="#">PE4764</a>	\$20.83	\$19.37	\$17.91	\$16.66	53

## Banana Connectors, [See Web](#) (2 parts available)

## C Connectors

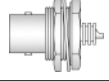
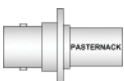
Connection Method	Product Image	Attachment Cable/Contact	Coax Type / Termination Type	Model No.	Price				ROW
					1-24	25-49	50-99	100 +	
<b>Male</b>									
Cable Connectors		Crimp/Solder	RG214, RG9, RG225, RG393	<a href="#">PE4375</a>	\$27.18	\$25.28	\$23.37	\$21.74	54
			RG55, RG141, RG142, RG223, RG400	<a href="#">PE4445</a>	\$26.52	\$24.66	\$22.81	\$21.22	55
			RG58, RG303, RG141, PE-C195, PE-P195, LMR-195, .195 inch	<a href="#">PE4517</a>	\$34.30	\$31.90	\$29.50	\$27.44	56
		Clamp/Solder	RG55, RG58, RG141, RG142, RG223, RG303, RG400, PE-C195, PE-P195, LMR-195	<a href="#">PE4242</a>	\$44.90	\$41.76	\$38.61	\$35.92	57
			RG213, RG214, RG8, RG9, RG11*, RG225, RG393, RG144*, RG216*, RG215	<a href="#">PE4243</a>	\$39.11	\$36.37	\$33.63	\$31.29	58
			RG213, RG214, RG8, RG9, RG11*, RG225, RG393, RG144*, RG216*, RG215	<a href="#">PE4950</a>	\$43.69	\$40.63	\$37.57	\$34.95	59
RG14, RG217			<a href="#">PE4951</a>	\$53.15	\$49.43	\$45.71	\$42.52	60	
		RG59*, RG62*, RG71	<a href="#">PE4952</a>	\$39.78	\$37.00	\$34.21	\$31.82	61	
<b>Male, 4 Hole Flange Mount</b>									
Terminal		Solder	Solder Cup with .718 inch Hole Spacing	<a href="#">PE44096</a>	\$60.00	\$55.80	\$51.60	\$48.00	62
<b>Male Right Angle</b>									
Cable Connectors		Crimp/Solder	RG214, RG9, RG225, RG393	<a href="#">PE4949</a>	\$76.44	\$71.09	\$65.74	\$61.15	63
			RG55, RG141, RG142, RG223, RG400	<a href="#">PE4958</a>	\$62.07	\$57.73	\$53.38	\$49.66	64
			PE-P195, PE-C195, RG58, RG141, RG303, .195 inch, LMR-195	<a href="#">PE4959</a>	\$78.24	\$72.76	\$67.29	\$62.59	65
		Clamp/Solder	RG213, RG214, RG8, RG9, RG11*, RG225, RG393, RG144*, RG216*, RG215	<a href="#">PE4244</a>	\$65.87	\$61.26	\$56.65	\$52.70	66
			RG55, RG58, RG141, RG142, RG223, RG303, RG400, PE-C195, PE-P195, LMR-195	<a href="#">PE4957</a>	\$81.89	\$76.16	\$70.43	\$65.51	67
<b>Female</b>									
Cable Connectors		Clamp/Solder	RG213, RG214, RG8, RG9, RG11*, RG225, RG393, RG144*, RG216*, RG215	<a href="#">PE4960</a>	\$53.52	\$49.77	\$46.03	\$42.82	68
			RG55, RG58, RG141, RG142, RG223, RG303, RG400, PE-C195, PE-P195, LMR-195	<a href="#">PE4961</a>	\$72.69	\$67.60	\$62.51	\$58.15	69
<b>Female, Bulkhead Mount</b>									
Cable Connectors		Clamp/Solder	RG58, RG142, RG223, RG400, RG141, RG303, RG55, LMR-400, PE-C195, PE-P195 with .596 inch D Hole	<a href="#">PE44099</a>	\$64.15	\$59.66	\$55.17	\$51.17	70
			RG214, RG213, RG393, RG8, RG225, RG11*, RG216*, RG144*, RG215, RG9 with .720 inch D Hole	<a href="#">PE4964</a>	\$60.88	\$56.62	\$52.36	\$48.70	71
Terminal		Solder	Solder Cup with .720 inch D Hole	<a href="#">PE4240</a>	\$48.94	\$45.51	\$42.09	Call	72
			Turret with .350 inch D Hole	<a href="#">PE4973</a>	\$72.02	\$66.98	\$61.94	\$57.62	73
<b>Female, 4 Hole Flange Mount</b>									
Cable Connectors		Crimp/Solder	RG214, RG9, RG225, RG393 with .718 inch Hole Spacing	<a href="#">PE4374</a>	\$60.51	\$56.27	\$52.04	\$48.41	74
			RG214, RG213, RG393, RG8, RG225, RG11*, RG216*, RG144*, RG215, RG9 with .718 inch Hole Spacing	<a href="#">PE4967</a>	\$72.69	\$67.60	\$62.51	\$58.15	75
			RG58, RG142, RG223, RG400, RG141, RG303, RG55, LMR-400, PE-C195, PE-P195 with .718 inch Hole Spacing	<a href="#">PE4969</a>	\$52.89	\$49.19	\$45.49	\$42.31	76

\* Fits MIL-C-17 and equivalent cable versions only





Connectors

See Our Website For Current Pricing & Real-Time Stock Availability!

# C Connectors





Connection Method	Product Image	Attachment Cable/Contact	Coax Type / Termination Type	Model No.	Price				ROW
					1-24	25-49	50-99	100 +	
Terminal		Solder	Solder Cup with .718 inch Hole Spacing	<a href="#">PE4241</a>	\$21.25	\$19.76	\$18.28	\$17.00	77
			Solder Cup with .718 inch Hole Spacing	<a href="#">PE44117</a>	\$33.53	\$31.18	\$28.84	\$26.82	78

# D-Sub Connectors

Connection Method	Product Image	Attachment Cable/Contact	Coax Type / Termination Type	Model No.	Price				ROW
					1-24	25-49	50-99	100 +	
<b>Plug</b>									
Cable Connectors		Crimp/Solder	RG174, RG316, RG188, .100 inch, PE-B100, PE-C100, LMR-100	<a href="#">PE4809</a>	\$18.04	\$16.78	\$15.51	\$14.43	79
			RG55, RG142, RG223, RG400	<a href="#">PE4842</a>	\$14.21	\$13.22	\$12.22	\$11.37	80
		Solder/Solder	RG174, RG316, RG187, RG188	<a href="#">PE4813</a>	\$13.72	\$12.76	\$11.80	\$10.98	81
			RG180, RG195, PE-B150	<a href="#">PE4815</a>	\$18.31	\$17.03	\$15.75	\$14.65	82
<b>Plug Right Angle</b>									
PCB Mount		Solder	Thru Hole with .200 inch x .046 inch Hole Spacing	<a href="#">PE4835</a>	\$21.58	\$20.07	\$18.56	\$17.26	83
<b>Receptacle</b>									
Cable Connectors		Crimp/Solder	RG174, RG316, RG188, .100 inch, PE-B100, PE-C100, LMR-100	<a href="#">PE4801</a>	\$15.48	\$14.40	\$13.31	\$12.38	84
			RG55, RG142, RG223, RG400	<a href="#">PE4837</a>	\$11.65	\$10.83	\$10.02	\$9.32	85
<b>Receptacle Right Angle</b>									
Cable Connectors		Crimp/Solder	RG58, RG141, RG303	<a href="#">PE4816</a>	\$19.75	\$18.37	\$16.99	\$15.80	86
		Solder/Solder	RG58, RG141, RG303	<a href="#">PE4820</a>	\$12.28	\$11.42	\$10.56	\$9.82	87
			PE-SR402AL, PE-SR402FL, RG402	<a href="#">PE4849</a>	\$24.43	\$22.72	\$21.01	\$19.54	88

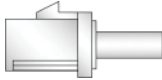
# F Connectors, [See Web](#) (28 parts available)

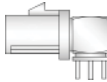
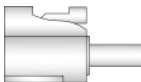
# FAKRA Connectors

Connection Method	Product Image	Attachment Cable/Contact	Coax Type / Termination Type	Model No.	Price				ROW
					1-24	25-49	50-99	100 +	
<b>Plug</b>									
Cable Connectors		Crimp/Solder	RG174, RG316, RG188, .100 inch, PE-B100, PE-C100, LMR-100 with Violet Color	<a href="#">PE45404H</a>	\$5.18	\$4.82	\$4.45	\$4.14	89
			RG174, RG316, RG188, .100 inch, PE-B100, PE-C100, LMR-100 with Water Blue Color	<a href="#">PE45404Z</a>	\$5.18	\$4.82	\$4.45	\$4.14	90
PCB Mount		Solder	Thru Hole with Black Color	<a href="#">PE44649A</a>	\$5.18	\$4.82	\$4.45	\$4.14	91
			Thru Hole with Water Blue Color	<a href="#">PE44649Z</a>	\$5.60	\$5.21	\$4.82	\$4.48	92
<b>Plug Right Angle</b>									
PCB Mount		Solder	Thru Hole with Black Color	<a href="#">PE44651A</a>	\$7.26	\$6.75	\$6.24	\$5.81	93
			Thru Hole with Blue Color	<a href="#">PE44651C</a>	\$7.26	\$6.75	\$6.24	\$5.81	94
			Thru Hole with Water Blue Color	<a href="#">PE44651Z</a>	\$7.00	\$6.51	\$6.02	\$5.60	95
<b>Jack</b>									
Cable Connectors		Crimp/Solder	RG174, RG316, RG188, .100 inch, PE-B100, PE-C100, LMR-100 with Black Color	<a href="#">PE44646A</a>	\$5.97	\$5.55	\$5.13	\$4.78	96
			RG174, RG316, RG188, .100 inch, PE-B100, PE-C100, LMR-100 with Blue Color	<a href="#">PE44646C</a>	\$5.97	\$5.55	\$5.13	\$4.78	97
			RG174, RG316, RG188, .100 inch, PE-B100, PE-C100, LMR-100 with Water Blue Color	<a href="#">PE44646Z</a>	\$5.70	\$5.30	\$4.90	\$4.56	98
<b>Jack Right Angle</b>									
Cable Connectors		Crimp/Solder	RG174, RG316, RG188, .100 inch, PE-B100, PE-C100, LMR-100 with Water Blue Color	<a href="#">PE44648Z</a>	\$7.13	\$6.63	\$6.13	\$5.70	99

\* Fits MIL-C-17 and equivalent cable versions only



Free Shipping Available via UPS Ground to USA & Canada



Technical Support (866) 727-8376



Same-Day Shipping, Even Custom Cable Assemblies

Connectors

See Our Website For Current Pricing & Real-Time Stock Availability!

# FAKRA Connectors

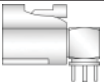



Connection Method	Product Image	Attachment Cable/Contact	Coax Type / Termination Type	Model No.	Price				ROW
					1-24	25-49	50-99	100 +	
PCB Mount		Solder	Thru Hole with Water Blue Color	<a href="#">PE44650Z</a>	\$7.72	\$7.18	\$6.64	\$6.18	1

# FME Connectors, [See Web](#) (7 parts available)

# GR874 Connectors

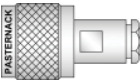
Connection Method	Product Image	Attachment Cable/Contact	Coax Type / Termination Type	Model No.	Price				ROW
					1-24	25-49	50-99	100 +	
Cable Connectors	<b>Sexless</b>								
		Accessories		<a href="#">PE4348</a>	\$42.58	\$39.60	\$36.62	\$34.06	2

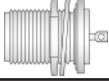
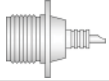

# HN Connectors

Connection Method	Product Image	Attachment Cable/Contact	Coax Type / Termination Type	Model No.	Price				ROW		
					1-24	25-49	50-99	100 +			
Cable Connectors	<b>Male</b>										
		Crimp/Solder	RG213, RG215, RG8	<a href="#">PE4473</a>	\$37.84	\$35.19	\$32.54	\$30.27	3		
			RG214, RG9, RG225, RG393	<a href="#">PE4474</a>	\$41.15	\$38.27	\$35.39	\$32.92	4		
			RG55, RG142, RG223, RG400, RG141	<a href="#">PE4477</a>	\$34.97	\$32.52	\$30.07	\$27.98	5		
			RG58, RG141	<a href="#">PE4478</a>	\$30.57	\$28.43	\$26.29	\$24.46	6		
		Clamp/Solder	RG213, RG214, RG8, RG9, RG225, RG393	<a href="#">PE4182</a>	\$25.96	\$24.14	\$22.33	\$20.77	7		
			RG58, RG55, RG141, RG142, RG223, RG400, RG303, PE-C195, PE-P195, LMR-195	<a href="#">PE4198</a>	\$33.21	\$30.89	\$28.56	\$26.57	8		
			RG14, RG217	<a href="#">PE4475</a>	\$44.39	\$41.28	\$38.18	\$35.51	9		
			RG59*, RG62*, RG71	<a href="#">PE4479</a>	\$47.37	\$44.05	\$40.74	\$37.90	10		
			Cable Connectors		Clamp/Solder	RG213, RG8, RG393, RG225, RG214, RG393, RG9	<a href="#">PE4230</a>	\$58.99	\$54.86	\$50.73	\$47.19
RG55, RG58, RG141, RG142, RG223, RG303, RG400, PE-C195, PE-P195, LMR-195						<a href="#">PE4480</a>	\$67.16	\$62.46	\$57.76	\$53.73	12
RG14, RG217	<a href="#">PE4530Z</a>	\$68.57				\$63.77	\$58.97	\$54.86	13		
Cable Connectors	<b>Female</b>										
		Clamp/Solder	RG213, RG8, RG225, RG214, RG393	<a href="#">PE4229</a>	\$52.20	\$48.55	\$44.89	\$41.76	14		
Terminal	<b>Female, Bulkhead Mount</b>										
		Solder	Turret with .765 inch DD Hole	<a href="#">PE4481</a>	\$57.30	\$53.29	\$49.28	\$45.84	15		
Terminal	<b>Female, 4 Hole Flange Mount</b>										
		Solder	Solder Cup with .906 inch Hole Spacing	<a href="#">PE4183</a>	\$28.56	\$26.56	\$24.56	\$22.85	16		
		Field Replaceable	Slotted Contact	<a href="#">PE44718</a>	\$56.56	\$52.60	\$48.64	\$45.25	17		

PasterFact™:  
Electromagnetic waves always travel at the same speed (299,792 km per second).



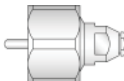
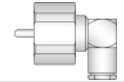

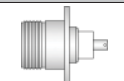

\* Fits MIL-C-17 and equivalent cable versions only

# LC Connectors

Connection Method	Product Image	Attachment Cable/Contact	Coax Type / Termination Type	Model No.	Price				ROW
					1-24	25-49	50-99	100 +	
<b>Male</b>									
Cable Connectors		Clamp/Solder	RG218, RG219, RG17	<a href="#">PE4323</a>	\$196.59	\$182.83	\$169.07	\$157.27	18
			RG14, RG217	<a href="#">PE4563</a>	\$175.94	\$163.62	\$151.31	\$140.75	19
			RG213, RG214, RG8, RG9, RG225, RG393, RG215	<a href="#">PE4564</a>	\$147.30	\$136.99	\$126.68	\$117.84	20
			RG55, RG58, RG141, RG142, RG223, RG303, RG400, PE-C195, PE-P195, LMR-195	<a href="#">PE4565</a>	\$129.28	\$120.23	\$111.18	\$103.42	21
<b>Male Right Angle</b>									
Cable Connectors		Clamp/Solder	RG213, RG214, RG8, RG9, RG225, RG393, RG215	<a href="#">PE44447</a>	\$226.48	\$210.63	\$194.77	\$181.18	22
<b>Female</b>									
Cable Connectors		Clamp/Solder	RG17, RG218, RG219	<a href="#">PE44451</a>	\$242.35	\$225.39	\$208.42	\$193.88	23
<b>Female, 4 Hole Flange Mount</b>									
Terminal		Solder	Pin with 1.44 inch Hole Spacing	<a href="#">PE4192</a>	\$101.09	\$94.01	\$86.94	\$80.87	24

## MC-Card Connectors, [See Web](#) (6 parts available)

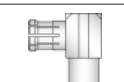
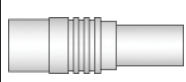
# MCX Connectors

Connection Method	Product Image	Attachment Cable/Contact	Coax Type / Termination Type	Model No.	Price				ROW
					1-24	25-49	50-99	100 +	
<b>Plug</b>									
Cable Connectors		Crimp/Solder	RG316, RG174, RG188, LMR-100, PE-B100, PE-C100, .100 inch	<a href="#">PE4551</a>	\$13.00	\$12.09	\$11.18	\$10.40	25
			RG178, RG196	<a href="#">PE4552</a>	\$16.99	\$15.80	\$14.61	\$13.59	26
			RG188-DS, RG316-DS	<a href="#">PE4878</a>	\$11.65	\$10.83	\$10.02	\$9.32	27
			RG55, RG141, RG142, RG223, RG400	<a href="#">PE4881</a>	\$24.60	\$22.88	\$21.16	\$19.68	28
PCB Mount		Solder	Surface Mount	<a href="#">PE44613</a>	\$14.35	\$13.35	\$12.34	\$11.48	29
	Thru Hole with .200 inch x .052 inch Hole Spacing		<a href="#">PE4559</a>	\$18.74	\$17.43	\$16.12	\$14.99	30	
Cable Connectors		Solder	PE-SR405AL, PE-SR405FL, PE-SR405FLJ, PE-SR405TN, RG405	<a href="#">PE4876</a>	\$22.93	\$21.32	\$19.72	\$18.34	31
<b>Plug Right Angle</b>									
Cable Connectors		Crimp/Solder	RG174, RG316, RG188, LMR-100, PE-B100, PE-C100, .100 inch	<a href="#">PE4553</a>	\$15.80	\$14.69	\$13.59	\$12.64	32
			RG178, RG196	<a href="#">PE4554</a>	\$16.01	\$14.89	\$13.77	\$12.81	33
			RG58, RG303, RG141, PE-C195, PE-P195, LMR-195, .195 inch	<a href="#">PE4882</a>	\$18.50	\$17.21	\$15.91	\$14.80	34
			Solder/Solder	PE-SR405AL, PE-SR405FL, PE-SR405FLJ, PE-SR405TN, RG405	<a href="#">PE44698</a>	\$7.23	\$6.72	\$6.22	\$5.78
<b>Jack</b>									
Cable Connectors		Crimp/Solder	RG188-DS, RG316-DS	<a href="#">PE4885</a>	\$15.18	\$14.12	\$13.05	\$12.14	36
PCB Mount		Solder	Thru Hole with .200 inch x .067 inch Hole Spacing	<a href="#">PE44303</a>	\$14.83	\$13.79	\$12.75	\$11.86	37
			Thru Hole with .200 inch x .052 inch Hole Spacing	<a href="#">PE4555</a>	\$11.59	\$10.78	\$9.97	\$9.27	38
			.042 inch End Launch	<a href="#">PE4893</a>	\$19.86	\$18.47	\$17.08	\$15.89	39

\* Fits MIL-C-17 and equivalent cable versions only



Free Shipping Available  
via UPS Ground to  
USA & Canada



Technical Support  
(866) 727-8376







Same-Day Shipping,  
Even Custom  
Cable Assemblies

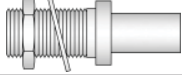

Connectors

See Our Website For Current Pricing & Real-Time Stock Availability!



# MCX Connectors

Connection Method	Product Image	Attachment Cable/Contact	Coax Type / Termination Type	Model No.	Price				ROW
					1-24	25-49	50-99	100 +	
<b>Jack, Bulkhead Mount</b>									
Cable Connectors		Crimp/Solder	RG174, RG316, RG188, LMR-100, PE-B100, PE-C100, .100 inch with .177 inch D Hole	<a href="#">PE4887</a>	\$19.69	\$18.31	\$16.93	\$15.75	40
Terminal		Solder	Turret with .177 inch D Hole	<a href="#">PE4561</a>	\$16.31	\$15.17	\$14.03	\$13.05	41
<b>Jack, 2 Hole Flange Mount</b>									
Terminal		Solder	Solder Cup with .328 inch Hole Spacing	<a href="#">PE4891</a>	\$23.74	\$22.08	\$20.42	\$18.99	42
			Pin with .328 inch Hole Spacing	<a href="#">PE4894</a>	\$20.99	\$19.52	\$18.05	\$16.79	43
<b>Jack Right Angle</b>									
PCB Mount		Solder	Thru Hole with .200 inch x .052 inch Hole Spacing	<a href="#">PE45274</a>	\$12.97	\$12.06	\$11.15	\$10.38	44
			Thru Hole with .200 inch x .052 inch Hole Spacing	<a href="#">PE4556</a>	\$14.56	\$13.54	\$12.52	\$11.65	45

# Reverse Polarity MCX Connectors

Connection Method	Product Image	Attachment Cable/Contact	Coax Type / Termination Type	Model No.	Price				ROW
					1-24	25-49	50-99	100 +	
<b>Plug Right Angle</b>									
Cable Connectors		Crimp/Solder	RG316, RG188, RG174	<a href="#">PE45050</a>	\$7.04	\$6.55	\$6.05	\$5.63	46
<b>Jack Right Angle, Bulkhead Mount</b>									
PCB Mount		Solder	Thru Hole with .177 inch D Hole	<a href="#">PE44376</a>	\$30.17	\$28.06	\$25.95	\$24.14	47

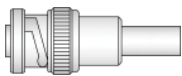
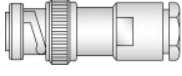
# MHV Connectors





Connection Method	Product Image	Attachment Cable/Contact	Coax Type / Termination Type	Model No.	Price				ROW
					1-24	25-49	50-99	100 +	
<b>Male</b>									
Cable Connectors		Crimp/Solder	RG59*, RG62*, RG71	<a href="#">PE4075</a>	\$15.15	\$14.09	\$13.03	\$12.12	48
			RG58, RG303, RG141, PE-C195, PE-P195, LMR-195, .195 inch	<a href="#">PE4093</a>	\$24.65	\$22.92	\$21.20	\$19.72	49
			RG213, RG8	<a href="#">PE4493</a>	\$29.10	\$27.06	\$25.03	\$23.28	50
			RG55, RG141, RG142, RG223, RG400	<a href="#">PE4657</a>	\$17.90	\$16.65	\$15.39	\$14.32	51
			RG174, RG316, RG188, LMR-100, PE-B100, PE-C100, .100 inch	<a href="#">PE4933</a>	\$38.14	\$35.47	\$32.80	\$30.51	52
			RG58, RG55, RG141, RG142, RG223, RG400, RG303, PE-C195, PE-P195, LMR-195	<a href="#">PE4076</a>	\$14.29	\$13.29	\$12.29	\$11.43	53
Cable Connectors		Clamp/Solder	RG59*, RG62*, RG71	<a href="#">PE4098</a>	\$14.56	\$13.54	\$12.52	\$11.65	54
			RG213, RG214, RG8, RG9, RG11*, RG225, RG393, RG144*, RG216*, RG215	<a href="#">PE4299</a>	\$29.89	\$27.80	\$25.71	\$23.91	55
			RG174, RG316, RG188	<a href="#">PE4494</a>	\$15.72	\$14.62	\$13.52	\$12.58	56
			<b>Male Right Angle</b>						
Cable Connectors		Clamp/Solder	RG58, RG55, RG141, RG142, RG223, RG400, RG303, PE-C195, PE-P195, LMR-195	<a href="#">PE4226</a>	\$32.32	\$30.06	\$27.80	\$25.86	57
			RG59*, RG62*, RG71	<a href="#">PE4227</a>	\$31.60	\$29.39	\$27.18	\$25.28	58
			RG174, RG316, RG188	<a href="#">PE4710</a>	\$30.57	\$28.43	\$26.29	\$24.46	59
<b>Female</b>									
Cable Connectors		Crimp/Solder	PE-P195, PE-C195, RG58, RG141, RG303, .195 inch, LMR-195	<a href="#">PE44102</a>	\$27.18	\$25.28	\$23.37	\$21.74	60

\* Fits MIL-C-17 and equivalent cable versions only



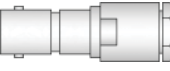

Connectors

See Our Website For Current Pricing & Real-Time Stock Availability!

# MHV Connectors

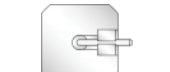
Connection Method	Product Image	Attachment Cable/Contact	Coax Type / Termination Type	Model No.	Price				ROW
					1-24	25-49	50-99	100 +	
<b>Female</b>									
Cable Connectors		Clamp/Solder	RG59*, RG62*, RG71	<a href="#">PE4181</a>	\$22.12	\$20.57	\$19.02	\$17.70	61
			RG58, RG55, RG141, RG142, RG223, RG400, RG303, PE-C195, PE-P195, LMR-195	<a href="#">PE4225</a>	\$23.90	\$22.23	\$20.55	\$19.12	62
			RG174, RG316, RG188	<a href="#">PE44104</a>	\$26.20	\$24.37	\$22.53	\$20.96	63
<b>Female, Bulkhead Mount</b>									
Cable Connectors		Crimp/Solder	RG58, RG303, RG141, PE-C195, PE-P195, LMR-195, .195 inch	<a href="#">PE44108</a>	\$35.78	\$33.28	\$30.77	\$28.62	64
			RG59*, RG62*, RG71	<a href="#">PE44110</a>	\$47.10	\$43.80	\$40.51	\$37.68	65
Terminal		Solder	Solder Cup with .380 inch DD Hole	<a href="#">PE4193</a>	\$21.07	\$19.60	\$18.12	\$16.86	67
			Solder Cup with .380 inch DD Hole	<a href="#">PE4311</a>	\$45.46	\$42.28	\$39.10	\$36.37	68
			Turret with .537 inch D Hole	<a href="#">PE4312</a>	\$35.52	\$33.03	\$30.55	\$28.42	69
			Solder Cup with .480 inch D Hole	<a href="#">PE4495</a>	\$43.71	\$40.65	\$37.59	\$34.97	70
<b>Female, 4 Hole Flange Mount</b>									
Cable Connectors		Clamp/Solder	RG58, RG142, RG223, RG400, RG141, RG303, RG55, LMR-400, PE-C195, PE-P195 with .500 inch Threaded Hole Spacing	<a href="#">PE4313</a>	\$42.27	\$39.31	\$36.35	\$33.82	71
			RG214, RG213, RG393, RG8, RG225, RG11*, RG216*, RG144*, RG215, RG9 with .718 inch Hole Spacing	<a href="#">PE44112</a>	\$48.46	\$45.07	\$41.68	\$38.77	72
Terminal		Solder	Solder Cup with .500 inch Threaded Hole Spacing	<a href="#">PE4228</a>	\$28.15	\$26.18	\$24.21	\$22.52	73
			Solder Cup	<a href="#">PE45035</a>	\$52.10	\$48.45	\$44.81	\$41.68	74

# Mini SMP Connectors

Connection Method	Product Image	Attachment Cable/Contact	Coax Type / Termination Type	Model No.	Price				ROW
					1-24	25-49	50-99	100 +	
<b>Male</b>									
PCB Mount		Solder	Surface Mount	<a href="#">PE44489</a>	\$30.83	\$28.67	\$26.51	\$24.66	75
			End Launch	<a href="#">PE44490</a>	\$24.11	\$22.42	\$20.73	\$19.29	76
			Edge Launch	<a href="#">PE44969</a>	\$28.40	\$26.41	\$24.42	\$22.72	77
			Thru Hole	<a href="#">PE44970</a>	\$53.81	\$50.04	\$46.28	\$43.05	78
<b>Male Right Angle</b>									
PCB Mount		Solder	Surface Mount	<a href="#">PE44968</a>	\$65.44	\$60.86	\$56.28	\$52.35	79
<b>Female</b>									
Cable Connectors		Solder	PE-047SR, PE-SR047AL, PE-SR047FL	<a href="#">PE44491</a>	\$35.52	\$33.03	\$30.55	\$28.42	80
			PE-SR405AL, PE-SR405FL, PE-SR405FLJ, PE-SR405TN, RG405	<a href="#">PE44492</a>	\$35.04	\$32.59	\$30.13	\$28.03	81
			PE-SR405AL, PE-SR405FL, PE-SR405FLJ, PE-SR405TN, RG405	<a href="#">PE44974</a>	\$34.38	\$31.97	\$29.57	\$27.50	82
<b>Female Right Angle</b>									
Cable Connectors		Solder	PE-047SR, PE-SR047AL, PE-SR047FL	<a href="#">PE44493</a>	\$45.27	\$42.10	\$38.93	\$36.22	83
			PE-SR405AL, PE-SR405FL, PE-SR405FLJ, PE-SR405TN, RG405	<a href="#">PE44494</a>	\$40.73	\$37.88	\$35.03	\$32.58	84

# Mini UHF Connectors

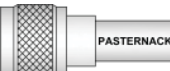
Connection Method	Product Image	Attachment Cable/Contact	Coax Type / Termination Type	Model No.	Price				ROW
					1-24	25-49	50-99	100 +	
<b>Male</b>									
Cable Connectors		Crimp/Solder	RG58, RG303, RG141, PE-C195, PE-P195, LMR-195, .195 inch	<a href="#">PE4342</a>	\$6.40	\$5.95	\$5.50	\$5.12	85

\* Fits MIL-C-17 and equivalent cable versions only



Free Shipping Available  
via UPS Ground to  
USA & Canada



Technical Support  
(866) 727-8376





Same-Day Shipping,  
Even Custom  
Cable Assemblies



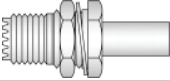

Connectors

See Our Website For Current Pricing & Real-Time Stock Availability!

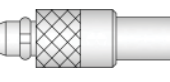

# Mini UHF Connectors

Connection Method	Product Image	Attachment Cable/Contact	Coax Type / Termination Type	Model No.	Price				ROW
					1-24	25-49	50-99	100 +	
<b>Female, Bulkhead Mount</b>									
Cable Connectors		Crimp/Solder	.195 inch, RG58, RG141, RG303, LMR-195, LMR-195-FR, PE-C195, PE-P195 with .410 inch D Hole	<a href="#">PE44087</a>	\$14.30	\$13.30	\$12.30	\$11.44	86
PCB Mount		Solder	Thru Hole with .380 inch Diameter	<a href="#">PE44092</a>	\$10.17	\$9.46	\$8.75	\$8.14	87

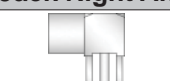
# MMCX Connectors

Connection Method	Product Image	Attachment Cable/Contact	Coax Type / Termination Type	Model No.	Price				ROW
					1-24	25-49	50-99	100 +	
<b>Plug</b>									
Cable Connectors		Crimp/Solder	RG174, RG316, RG188, LMR-100, PE-B100, PE-C100, .100 inch	<a href="#">PE4896</a>	\$16.24	\$15.10	\$13.97	\$12.99	88
		Solder	PE-047SR, PE-SR047AL, PE-SR047FL	<a href="#">PE44456</a>	\$21.58	\$20.07	\$18.56	\$17.26	89
PCB Mount			End Launch	<a href="#">PE44663</a>	\$20.09	\$18.68	\$17.28	\$16.07	90
<b>Plug Right Angle</b>									
Cable Connectors		Crimp/Solder	RG174, RG316, RG188, LMR-100, PE-B100, PE-C100, .100 inch	<a href="#">PE4898</a>	\$12.17	\$11.32	\$10.47	\$9.74	91
			RG178, RG196	<a href="#">PE4899</a>	\$17.33	\$16.12	\$14.90	\$13.86	92
		Solder/Solder	PE-SR405AL, PE-SR405FL, PE-SR405FLJ, PE-SR405TN, RG405	<a href="#">PE44699</a>	\$7.91	\$7.36	\$6.80	\$6.33	93
<b>Jack</b>									
PCB Mount		Solder	Thru Hole with .100 inch x .031 inch Hole Spacing	<a href="#">PE4904</a>	\$12.64	\$11.76	\$10.87	\$10.11	94
<b>Jack Right Angle</b>									
PCB Mount		Solder	Thru Hole with .100 inch x .031 inch Hole Spacing	<a href="#">PE4903</a>	\$21.10	\$19.62	\$18.15	\$16.88	95

# MMBX Connectors



Connection Method	Product Image	Attachment Cable/Contact	Coax Type / Termination Type	Model No.	Price				ROW
					1-24	25-49	50-99	100 +	
<b>Plug</b>									
Cable Connectors		Crimp/Solder	RG178, RG196	<a href="#">PE45250</a>	\$12.22	\$11.36	\$10.51	\$9.78	96
			RG316, RG174	<a href="#">PE45251</a>	\$12.22	\$11.36	\$10.51	\$9.78	97
			RG316-DS, RG188-DS	<a href="#">PE45252</a>	\$12.22	\$11.36	\$10.51	\$9.78	98
PCB Mount		Solder/Solder	Surface Mount	<a href="#">PE45259TR1</a>	\$17.09	\$15.89	\$14.70	\$13.67	99
			Surface Mount	<a href="#">PE45259TR750</a>	Call	Call	Call	Call	1
Cable Connectors		Solder/Non-Solder Contact	RG405, PE-SR405FL, PE-SR405FLJ	<a href="#">PE45253</a>	\$13.72	\$12.76	\$11.80	\$10.98	2

\* Fits MIL-C-17 and equivalent cable versions only

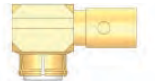

Connectors

See Our Website For Current Pricing & Real-Time Stock Availability!

# MMBX Connectors

Connection Method	Product Image	Attachment Cable/Contact	Coax Type / Termination Type	Model No.	Price				ROW
					1-24	25-49	50-99	100 +	
<b>Plug Right Angle</b>									
Cable Connectors		Crimp/Solder	RG178, RG196	<a href="#">PE45254</a>	\$15.86	\$14.75	\$13.64	\$12.69	3
			RG316, RG174	<a href="#">PE45255</a>	\$15.86	\$14.75	\$13.64	\$12.69	4
			RG316-DS, RG188-DS	<a href="#">PE45256</a>	\$15.86	\$14.75	\$13.64	\$12.69	5
		Solder/Solder	RG405, PE-SR405FL, PE-SR405FLJ	<a href="#">PE45257</a>	\$15.86	\$14.75	\$13.64	\$12.69	6
<b>Jack</b>									
PCB Mount		Solder	Edge Launch	<a href="#">PE45261</a>	\$15.60	\$14.51	\$13.42	\$12.48	7
			Surface Mount	<a href="#">PE45262TR1</a>	\$10.55	\$9.81	\$9.07	\$8.44	8
			Surface Mount	<a href="#">PE45262TR750</a>	Call	Call	Call	Call	9
			Through Hole	<a href="#">PE45265TR1</a>	\$13.26	\$12.33	\$11.40	\$10.61	10
			Through Hole	<a href="#">PE45265TR500</a>	Call	Call	Call	Call	11
<b>Jack, Thread-In</b>									
Terminal		Solder	Pin	<a href="#">PE45267</a>	\$11.86	\$11.03	\$10.20	\$9.49	12

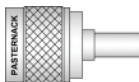
# N Connectors

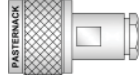
Connection Method	Product Image	Attachment Cable/Contact	Coax Type / Termination Type	Model No.	Price				ROW
					1-24	25-49	50-99	100 +	
<b>Male</b>									
Cable Connectors		Crimp/Crimp	RG55, RG141, RG142, RG223, RG400	<a href="#">PE4042</a>	\$17.41	\$16.19	\$14.97	\$13.93	13
			PE-C195, PE-P195, RG58, RG141, RG303, LMR-195, .195 inch	<a href="#">PE44520</a>	\$9.38	\$8.72	\$8.07	\$7.50	14
		Crimp/Solder	RG214, RG9, RG225, RG393	<a href="#">PE4048</a>	\$17.93	\$16.67	\$15.42	\$14.34	15
			RG58, RG141, RG303, LMR-195, PE-C195, PE-P195, .195 inch	<a href="#">PE4329</a>	\$13.11	\$12.19	\$11.27	\$10.49	16
			RG8X, PE-C240, .240 inch, B7808A, LMR-240	<a href="#">PE4344</a>	\$12.56	\$11.68	\$10.80	\$10.05	17
			RG174, RG316, RG188, LMR-100, PE-B100, PE-C100, .100 inch	<a href="#">PE4429</a>	\$16.73	\$15.56	\$14.39	\$13.38	18
			RG213, RG215, RG8	<a href="#">PE4430</a>	\$16.24	\$15.10	\$13.97	\$12.99	19
			RG59*, RG62*, RG71	<a href="#">PE4432</a>	\$14.70	\$13.67	\$12.64	\$11.76	20
			PE-C600, LMR-600, LMR-600-DB, .600 inch	<a href="#">PE44454</a>	\$27.50	\$25.58	\$23.65	\$22.00	21
			PE-C240, RG8X, .240 inch, LMR-240, LMR-240-DB, LMR-240-UF, B7808A	<a href="#">PE44521</a>	\$14.62	\$13.60	\$12.57	\$11.70	22
			PE-C400, PE-B400, PE-B405, LMR-400, LMR-400-DB, LMR-400-UF, .400 inch	<a href="#">PE44522</a>	\$16.53	\$15.37	\$14.22	\$13.22	23
			PE-C600, LMR-600, LMR-600-DB, .600 inch	<a href="#">PE44523</a>	\$55.31	\$51.44	\$47.57	\$44.25	24
			RG223, RG142, RG400, RG55	<a href="#">PE44788</a>	\$15.33	\$14.26	\$13.18	\$12.26	25
			RG188-DS, RG316-DS	<a href="#">PE45167</a>	\$15.72	\$14.62	\$13.52	\$12.58	26
			PE-B400, PE-B405, PE-C400, LMR-400, .400 inch	<a href="#">PE4550</a>	\$15.09	\$14.03	\$12.98	\$12.07	27
			LMR-195, PE-C195	<a href="#">TC-195-NMH-X</a>	\$13.69	\$13.69	\$13.69	\$13.69	28
			LMR-200, PE-C200	<a href="#">TC-200-NMH-X</a>	\$16.65	\$16.65	\$16.65	\$16.65	29
			LMR-240, PE-C240	<a href="#">TC-240-NMH-X</a>	\$12.51	\$12.51	\$12.51	\$12.51	30
			LMR-400, PE-C400, PE-B405	<a href="#">TC-400-NMH-X</a>	\$13.00	\$13.00	\$13.00	\$13.00	31
			LMR-600, PE-C600	<a href="#">TC-600-NMH-X</a>	\$19.08	\$19.08	\$19.08	\$19.08	32
	Clamp	7/8 inch Annular, 7/8 inch Helical, 7/8 inch Superflexible, 7/8 inch Flexible	<a href="#">PE44976</a>	\$52.46	\$48.79	\$45.12	\$41.97	33	
	Clamp/Solder	PE-SR402AL, PE-SR402FL, RG402	<a href="#">PE4006</a>	\$18.63	\$17.33	\$16.02	\$14.90	34	
		RG213, RG214, RG8, RG9, RG11*, RG225, RG393, RG144*, RG216*, RG215	<a href="#">PE4062</a>	\$15.37	\$14.29	\$13.22	\$12.30	35	
		RG58, RG55, RG141, RG142, RG223, RG400, RG303, PE-C195, PE-P195, LMR-195	<a href="#">PE4081</a>	\$12.17	\$11.32	\$10.47	\$9.74	36	
		PE-SR405AL, PE-SR405FL, RG405	<a href="#">PE4129</a>	\$18.63	\$17.33	\$16.02	\$14.90	37	
		PE-C400, PE-B400, PE-B405, LMR-400, LMR-400-DB, LMR-400-UF, .400 inch	<a href="#">PE4133</a>	\$20.64	\$19.20	\$17.75	\$16.51	38	
RG14, RG217	<a href="#">PE4221</a>	\$29.75	\$27.67	\$25.59	\$23.80	39			

\* Fits MIL-C-17 and equivalent cable versions only



Free Shipping Available via UPS Ground to USA & Canada











Technical Support (866) 727-8376

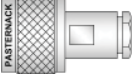
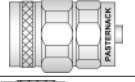

Same-Day Shipping, Even Custom Cable Assemblies

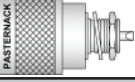
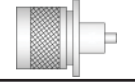

# N Connectors











Connection Method	Product Image	Attachment Cable/Contact	Coax Type / Termination Type	Model No.	Price				ROW
					1-24	25-49	50-99	100 +	
Cable Connectors	<b>Male</b>								
		Clamp/Solder	RG174, RG316, RG188	<a href="#">PE4224</a>	\$15.72	\$14.62	\$13.52	\$12.58	40
			RG59*, RG62*, RG71	<a href="#">PE4331</a>	\$17.26	\$16.05	\$14.84	\$13.81	41
			PE-C300	<a href="#">PE44045</a>	\$19.34	\$17.99	\$16.63	\$15.47	42
			PE-C500, LMR-500	<a href="#">PE44046</a>	\$32.39	\$30.12	\$27.86	\$25.91	43
			RG17, RG218, RG219	<a href="#">PE4433</a>	\$91.68	\$85.26	\$78.84	\$73.34	44
			PE-SR401AL, PE-SR401FL, RG401	<a href="#">PE4434</a>	\$18.63	\$17.33	\$16.02	\$14.90	45
		Threaded	VNA Test Cable	<a href="#">PE44485</a>	Call	Call	Call	Call	47
				Clamp/Solder	PE-P160LL	<a href="#">PE45446</a>	\$77.42	\$72.00	\$66.58
	LMR-240, PE-C240	<a href="#">TC-240-NMC</a>			\$15.63	\$15.63	\$15.63	\$15.63	49
		Clamp/Solder (Captive Contact)	RG213, RG214, RG8, RG9, RG11*, RG225, RG393, RG144*, RG216*, RG215	<a href="#">PE4132</a>	\$16.22	\$15.08	\$13.95	\$12.98	50
				Solder/Solder	PE-SR402AL, PE-SR402FL, PE-SR402FLJ, PE-SR402TN, RG402	<a href="#">PE4140</a>	\$23.66	\$22.00	\$20.35
	PE-SR401AL, PE-SR401FL, RG401	<a href="#">PE4376</a>			\$41.04	\$38.17	\$35.29	\$32.83	52
	SPP-250-LLPL	<a href="#">PE45427</a>			\$24.31	\$22.61	\$20.91	\$19.45	53
		Clamp/Non-Solder Contact	LMR-400, PE-C400, PE-B400, PE-B405	<a href="#">EZ-400-NMC-2-D</a>	\$23.13	\$23.13	\$23.13	\$23.13	54
			LMR-600, PE-C600	<a href="#">EZ-600-NMC-2-D</a>	\$36.99	\$36.99	\$36.99	\$36.99	55
			LMR-SW540	<a href="#">EZ-SW540-NMC</a>	\$22.20	\$22.20	\$22.20	\$22.20	56
			1/4 inch Superflexible, PE-1/4SFHC	<a href="#">PE44726</a>	\$52.69	\$49.00	\$45.31	\$42.15	57
			1/2 inch Helical, 1/2 inch Superflexible, PE-1/2 Helical, PE-1/2SFHC	<a href="#">PE44729</a>	\$36.80	\$34.22	\$31.65	\$29.44	58
		Crimp/Non-Solder Contact	LMR-200, PE-C200	<a href="#">EZ-200-NMH-X</a>	\$16.65	\$16.65	\$16.65	\$16.65	60
			LMR-240, PE-C240, RG8X	<a href="#">EZ-240-NMH-X</a>	\$12.34	\$12.34	\$12.34	\$12.34	61
			LMR-400, PE-C400	<a href="#">EZ-400-NMH-PL-X</a>	\$14.86	\$14.86	\$14.86	\$14.86	62
			LMR-400, PE-C400, PE-B400, PE-B405	<a href="#">EZ-400-NMH-X</a>	\$13.87	\$13.87	\$13.87	\$13.87	63
			LMR-600, PE-C600	<a href="#">EZ-600-NMH-X</a>	\$20.23	\$20.23	\$20.23	\$20.23	64
Terminal	<b>Male, Bulkhead Mount</b>								
		Solder	Solder Cup with .640 inch DD Hole	<a href="#">PE4489</a>	\$33.63	\$31.28	\$28.92	\$26.90	65
Solder Cup with .350 inch D Hole			<a href="#">PE4490</a>	\$36.43	\$33.88	\$31.33	\$29.14	66	
Terminal	<b>Male, 4 Hole Flange Mount</b>								
		Solder	Solder Cup with .718 inch Hole Spacing	<a href="#">PE4131</a>	\$14.92	\$13.88	\$12.83	\$11.94	67
			Pin with .718 inch Hole Spacing	<a href="#">PE44653</a>	\$70.45	\$65.52	\$60.59	\$56.36	68
Pin with .718 inch Hole Spacing			<a href="#">PE4491</a>	\$29.86	\$27.77	\$25.68	\$23.89	69	
Cable Connectors	<b>Male Right Angle</b>								
		Crimp/Solder	PE-C195, PE-P195, RG58, RG141, RG303, LMR-195, .195 inch	<a href="#">PE44524</a>	\$31.12	\$28.94	\$26.76	\$24.90	70
			PE-C240, RG8X, .240 inch, LMR-240, LMR-240-DB, LMR-240-UF, B7808A	<a href="#">PE44525</a>	\$48.59	\$45.19	\$41.79	\$38.87	71
			PE-C400, PE-B400, PE-B405, LMR-400, LMR-400-DB, LMR-400-UF, .400 inch	<a href="#">PE44526</a>	\$36.50	\$33.95	\$31.39	\$29.20	72
			PE-C600, LMR-600, LMR-600-DB, .600 inch	<a href="#">PE44527</a>	\$60.52	\$56.28	\$52.05	\$48.42	73
			RG174, RG316, RG188, .100 inch, PE-B100, PE-C100, LMR-100	<a href="#">PE44675</a>	\$27.76	\$25.82	\$23.87	\$22.21	74
			RG213, RG8	<a href="#">PE4482</a>	\$33.54	\$31.19	\$28.84	\$26.83	75
			RG214, RG9, RG225, RG393	<a href="#">PE4483</a>	\$43.89	\$40.82	\$37.75	\$35.11	76

\* Fits MIL-C-17 and equivalent cable versions only

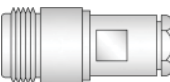
Connectors

See Our Website For Current Pricing & Real-Time Stock Availability!

# N Connectors

Connection Method	Product Image	Attachment Cable/Contact	Coax Type / Termination Type	Model No.	Price				ROW
					1-24	25-49	50-99	100 +	
<b>Male Right Angle</b>									
Cable Connectors		Crimp/Solder	RG55, RG141, RG142, RG223, RG400	<a href="#">PE4484</a>	\$27.98	\$26.02	\$24.06	\$22.38	77
			PE-C200, LMR-200	<a href="#">PE44844</a>	\$48.80	\$45.38	\$41.97	\$39.04	78
		Clamp/Solder	RG58, RG55, RG141, RG142, RG223, RG400, RG303, PE-C195, PE-P195, LMR-195	<a href="#">PE4135</a>	\$20.53	\$19.09	\$17.66	\$16.42	79
			RG213, RG8, RG215, RG225, RG214, RG393	<a href="#">PE4136</a>	\$23.66	\$22.00	\$20.35	\$18.93	80
			PE-P142LL	<a href="#">PE44816</a>	\$140.66	\$130.81	\$120.97	\$112.53	81
			1/2 inch Annular, 1/2 inch Flexible, PE-1/2FAC	<a href="#">PE45358</a>	\$76.55	\$71.19	\$65.83	\$61.24	82
			PE-P160LL	<a href="#">PE45448</a>	\$133.97	\$124.59	\$115.21	\$107.18	83
		Solder/Solder	PE-SR401AL, PE-SR401FL, RG401	<a href="#">PE4935</a>	\$27.60	\$25.67	\$23.74	\$22.08	84
			PE-SR405AL, PE-SR405FL, PE-SR405FLJ, RG405	<a href="#">PE44702</a>	\$19.41	\$18.05	\$16.69	\$15.53	85
			SPP-250-LLPL	<a href="#">PE45428</a>	\$28.48	\$26.49	\$24.49	\$22.78	86
			PE-SR402AL, PE-SR402FL, RG402	<a href="#">PE4936</a>	\$30.14	\$28.03	\$25.92	\$24.11	87
			PE-SR405AL, PE-SR405FL, PE-SR405FLJ, RG405	<a href="#">PE4937</a>	\$25.67	\$23.87	\$22.08	\$20.54	88
		Crimp/Non-Solder Contact	LMR-400, PE-C400, PE-B400	<a href="#">TC-400-NMH-RA-D</a>	\$20.81	\$20.81	\$20.81	\$20.81	89
			LMR-400, PE-C400, PE-B400, PE-B405	<a href="#">EZ-400-NMH-RA-X</a>	\$23.13	\$23.13	\$23.13	\$23.13	90
LMR-600, PE-C600			<a href="#">EZ-600-NMH-RA-X</a>	\$28.91	\$28.91	\$28.91	\$28.91	91	
<b>Female</b>									
Cable Connectors		Crimp/Solder	RG55, RG141, RG142, RG223, RG400	<a href="#">PE4134</a>	\$16.00	\$14.88	\$13.76	\$12.80	92
			RG214, RG9, RG225, RG393	<a href="#">PE4191</a>	\$15.25	\$14.18	\$13.12	\$12.20	93
			RG58	<a href="#">PE4436</a>	\$14.46	\$13.45	\$12.44	\$11.57	94
			PE-C195, PE-P195, RG58, RG141, RG303, LMR-195, .195 inch	<a href="#">PE44532</a>	\$14.90	\$13.86	\$12.81	\$11.92	95
			PE-C240, RG8X, .240 inch, LMR-240, LMR-240-DB, LMR-240-UF, B7808A	<a href="#">PE44533</a>	\$15.95	\$14.83	\$13.72	\$12.76	96
			PE-C400, PE-B400, PE-B405, LMR-400, LMR-400-DB, LMR-400-UF, .400 inch	<a href="#">PE44534</a>	\$23.44	\$21.80	\$20.16	\$18.75	97
			PE-C600, LMR-600, LMR-600-DB, .600 inch	<a href="#">PE44535</a>	\$44.90	\$41.76	\$38.61	\$35.92	98
			LMR-400, PE-C400	<a href="#">TC-400-NF-X</a>	\$17.85	\$17.85	\$17.85	\$17.85	99
		Clamp/Solder	RG213, RG214, RG8, RG9, RG11*, RG225, RG393, RG144*, RG216*, RG215	<a href="#">PE4061</a>	\$16.95	\$15.76	\$14.58	\$13.56	1
			RG58, RG55, RG141, RG142, RG223, RG400, RG303, PE-C195, PE-P195, LMR-195	<a href="#">PE4072</a>	\$16.15	\$15.02	\$13.89	\$12.92	2
			RG59*, RG62*, RG71	<a href="#">PE4330</a>	\$16.34	\$15.20	\$14.05	\$13.07	3
			PE-B400, PE-B405, PE-C400, LMR-400, .400 inch	<a href="#">PE4372</a>	\$27.89	\$25.94	\$23.99	\$22.31	4
			PE-C600	<a href="#">PE44350</a>	\$72.69	\$67.60	\$62.51	\$58.15	5
			PE-SR401AL, PE-SR401FL, RG401	<a href="#">PE4439</a>	\$21.77	\$20.25	\$18.72	\$17.42	6
	Clamp/Solder (Captive Contact)	RG213, RG214, RG8, RG9, RG11*, RG225, RG393, RG144*, RG216*, RG215	<a href="#">PE4059</a>	\$29.36	\$27.30	\$25.25	\$23.49	7	
			Solder/Solder	PE-SR402AL, PE-SR402FL, PE-SR402FLJ, PE-SR402TN, RG402	<a href="#">PE44705</a>	\$21.36	\$19.86	\$18.37	\$17.09
SPP-250-LLPL	<a href="#">PE45426</a>			\$24.31	\$22.61	\$20.91	\$19.45	9	
PCB Mount		Solder	Thru Hole with .400 inch x .062 inch Hole Spacing	<a href="#">PE44396</a>	\$24.34	\$22.64	\$20.93	\$19.47	11
			Cable Connectors	Clamp/Non-Solder Contact	1/2 inch Helical, 1/2 inch Superflexible, PE-1/2 Helical, PE-1/2SFHC	<a href="#">PE44731</a>	\$40.51	\$37.67	\$34.84
PE-1/2FAC, 1/2 inch Flexible, 1/2 inch Annular	<a href="#">PE44737</a>	\$40.51			\$37.67	\$34.84	\$32.41	13	
7/8 inch Helical	<a href="#">PE45203</a>	\$48.62			\$45.22	\$41.81	\$38.90	14	
Cable Connectors		Crimp/Non-Solder Contact	LMR-600, PE-C600	<a href="#">EZ-600-NF-X</a>	\$24.01	\$24.01	\$24.01	\$24.01	15
			<b>Female, Bulkhead Mount</b>						
Cable Connectors		Crimp/Solder	RG55, RG141, RG142, RG223, RG400 with .640 inch DD Hole	<a href="#">PE4371</a>	\$19.37	\$18.01	\$16.66	\$15.50	16

Connectors

See Our Website For Current Pricing & Real-Time Stock Availability!

\* Fits MIL-C-17 and equivalent cable versions only



Free Shipping Available  
via UPS Ground  
to USA & Canada









Technical Support  
(866) 727-8376

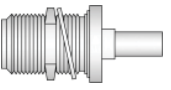
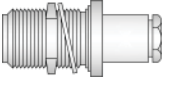

Same-Day Shipping,  
Even Custom  
Cable Assemblies

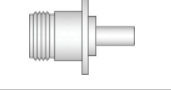
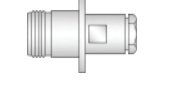
# N Connectors

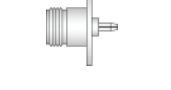



Connection Method	Product Image	Attachment Cable/Contact	Coax Type / Termination Type	Model No.	Price				ROW	
					1-24	25-49	50-99	100 +		
Cable Connectors	<b>Female, Bulkhead Mount</b>									
		Crimp/Solder	RG58 with .640 inch DD Hole	<a href="#">PE4440</a>	\$15.96	\$14.84	\$13.73	\$12.77	17	
			RG174, RG316, RG188, LMR-100, PE-B100, PE-C100, .100 inch with .640 inch DD Hole	<a href="#">PE4442</a>	\$27.31	\$25.40	\$23.49	\$21.85	18	
			.240 inch, RG8X, LMR-240, B7808A, LMR-240-DB, LMR-240-UF, PE-C240 with .640 inch DD Hole	<a href="#">PE44529</a>	\$16.45	\$15.30	\$14.15	\$13.16	19	
			.400 inch, LMR-400, LMR-400-DB, LMR-400-UF, PE-B405, PE-C400, PE-B400 with .640 inch DD Hole	<a href="#">PE44530</a>	\$22.51	\$20.93	\$19.36	\$18.01	20	
			RG188-DS, RG316-DS	<a href="#">PE44877</a>	\$26.42	\$24.57	\$22.72	\$21.14	21	
			LMR-200, PE-C200	<a href="#">PE45047</a>	\$22.60	\$22.60	\$22.60	\$22.60	22	
			RG214, RG9, RG225, RG393 with .640 inch DD Hole	<a href="#">PE4941</a>	\$16.86	\$15.68	\$14.50	\$13.49	23	
			LMR-240, PE-C240	<a href="#">TC-240-NF-BH-X</a>	\$27.28	\$27.28	\$27.28	\$27.28	24	
		Clamp/Solder	RG58, RG142, RG223, RG400, RG141, RG303, RG55, LMR-400, PE-C195, PE-P195 with .640 inch DD Hole	<a href="#">PE4114</a>	\$19.54	\$18.17	\$16.80	\$15.63	25	
			RG214, RG213, RG393, RG8, RG225, RG11*, RG216*, RG144*, RG215, RG9 with .640 inch DD Hole	<a href="#">PE4223</a>	\$24.11	\$22.42	\$20.73	\$19.29	26	
			RG174, RG316, RG188 with .640 inch DD Hole	<a href="#">PE4441</a>	\$20.20	\$18.79	\$17.37	\$16.16	27	
			PE-P300LL	<a href="#">PE44807</a>	\$99.81	\$92.82	\$85.84	\$79.85	28	
			PE-P142LL	<a href="#">PE44813</a>	\$84.46	\$78.55	\$72.64	\$67.57	29	
			PE-P160LL	<a href="#">PE45447</a>	\$102.71	\$95.52	\$88.33	\$82.17	30	
			PE-SR401AL, PE-SR401FL, RG401 with .640 inch DD Hole	<a href="#">PE4942</a>	\$23.17	\$21.55	\$19.93	\$18.54	31	
			PE-SR405AL, PE-SR405FL, PE-SR405FLJ, PE-SR405TN, RG405	<a href="#">PE44706</a>	\$21.36	\$19.86	\$18.37	\$17.09	32	
		Solder/Solder	PE-SR402AL, PE-SR402FL, PE-SR402FLJ, PE-SR402TN, RG402	<a href="#">PE44707</a>	\$20.96	\$19.49	\$18.03	\$16.77	33	
			PE-SR402AL, PE-SR402FL, PE-SR402FLJ, PE-SR402TN, RG402 with .640 inch DD Hole	<a href="#">PE4654</a>	\$34.47	\$32.06	\$29.64	\$27.58	34	
			PE-SR405AL, PE-SR405FL, RG405 with .640 inch DD Hole	<a href="#">PE4655</a>	\$34.40	\$31.99	\$29.58	\$27.52	35	
			Thru Hole with .640 inch DD Hole	<a href="#">PE44397</a>	\$33.80	\$31.43	\$29.07	\$27.04	36	
			End Launch with .630 inch Diameter	<a href="#">PE44615</a>	\$30.10	\$27.99	\$25.89	\$24.08	37	
			Solder Cup with .640 inch DD Hole	<a href="#">PE4137</a>	\$17.44	\$16.22	\$15.00	\$13.95	38	
	Terminal		Pin with .640 inch DD Hole	<a href="#">PE4139</a>	\$11.12	\$10.34	\$9.56	\$8.90	39	
			Solder Cup with .380 inch Diameter	<a href="#">PE4488</a>	\$13.22	\$12.29	\$11.37	\$10.58	40	
	Cable Connectors		Crimp/Non-Solder Contact	LMR-400, PE-C400, PE-B400, PE-B405	<a href="#">EZ-400-NF-BH</a>	\$23.13	\$23.13	\$23.13	\$23.13	41
	Terminal	<b>Female, 2 Hole Flange Mount</b>								
			Solder	Pin with 1.0 inch Hole Spacing	<a href="#">PE44079</a>	\$43.78	\$40.72	\$37.65	\$35.02	42
	Cable Connectors	<b>Female, 4 Hole Flange Mount</b>								
			Crimp/Solder	RG55, RG141, RG142, RG223, RG400 with .718 inch Hole Spacing	<a href="#">PE44068</a>	\$22.17	\$20.62	\$19.07	\$17.74	43
				.195 inch, RG58, RG141, RG303, LMR-195, LMR-195-FR, PE-C195, PE-P195 with .718 inch Hole Spacing	<a href="#">PE44069</a>	\$22.80	\$21.20	\$19.61	\$18.24	44
				RG316, RG174, LMR-100	<a href="#">PE45133</a>	\$20.50	\$19.07	\$17.63	\$16.40	45
			Clamp/Solder	RG58, RG142, RG223, RG400, RG141, RG303, RG55, LMR-400, PE-C195, PE-P195 with .718 inch Hole Spacing	<a href="#">PE4141</a>	\$16.77	\$15.60	\$14.42	\$13.42	46
				PE-SR401AL, PE-SR401FL, RG401 with .718 inch Hole Spacing	<a href="#">PE44071</a>	\$23.17	\$21.55	\$19.93	\$18.54	47
PE-SR402AL, PE-SR402FL, PE-SR402FLJ, PE-SR402TN, RG402 with .718 inch Hole Spacing				<a href="#">PE44072</a>	\$23.17	\$21.55	\$19.93	\$18.54	48	
PE-SR405AL, PE-SR405FL, RG405 with .718 inch Hole Spacing				<a href="#">PE44073</a>	\$22.81	\$21.21	\$19.62	\$18.25	49	
		Clamp/Solder (Captive Contact)	RG214, RG213, RG393, RG8, RG225, RG11*, RG216*, RG144*, RG215, RG9 with .718 inch Hole Spacing	<a href="#">PE4060</a>	\$24.56	\$22.84	\$21.12	\$19.65	50	
			Solder Cup with .718 inch Hole Spacing	<a href="#">PE4013</a>	\$11.92	\$11.09	\$10.25	\$9.54	51	
	Pin with .718 inch Hole Spacing		<a href="#">PE4328</a>	\$18.58	\$17.28	\$15.98	\$14.86	52		
Terminal		Solder	Pin with .340 inch Hole Spacing	<a href="#">PE4355</a>	\$19.07	\$17.74	\$16.40	\$15.26	53	
			Pin with .500 inch Hole Spacing	<a href="#">PE4444</a>	\$20.92	\$19.46	\$17.99	\$16.74	54	
			Solder Cup with .718 inch Hole Spacing	<a href="#">PE4487</a>	\$52.89	\$49.19	\$45.49	\$42.31	55	
			Tab with .718 inch Hole Spacing	<a href="#">PE4492</a>	\$27.29	\$25.38	\$23.47	\$21.83	56	
			Solder Cup	<a href="#">PE45085</a>	\$13.55	\$12.60	\$11.65	\$10.84	57	

\* Fits MIL-C-17 and equivalent cable versions only

Connectors

See Our Website For Current Pricing & Real-Time Stock Availability!

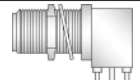
# N Connectors

Connection Method	Product Image	Attachment Cable/Contact	Coax Type / Termination Type	Model No.	Price				ROW
					1-24	25-49	50-99	100 +	
<b>Female, 4 Hole Flange Mount</b>									
Terminal		Field Replaceable	Slotted Contact	<a href="#">PE44721</a>	\$29.25	\$27.20	\$25.15	\$23.40	58
			Slotted Contact	<a href="#">PE44722</a>	\$29.54	\$27.47	\$25.40	\$23.63	59
<b>Female, Press-In</b>									
Terminal		Solder	Solder Cup with .500 inch Diameter	<a href="#">PE44076</a>	\$15.50	\$14.42	\$13.33	\$12.40	60
<b>Female Right Angle, Bulkhead Mount</b>									
PCB Mount		Solder	Thru Hole with .596 inch D Hole	<a href="#">PE44398</a>	\$25.36	\$23.58	\$21.81	\$20.29	61
<b>Female Right Angle, 4 Hole Flange Mount</b>									
Terminal		Solder	Solder Cup with .718 inch Hole Spacing	<a href="#">PE4486</a>	\$44.81	\$41.67	\$38.54	\$35.85	62

# Reverse Polarity N Connectors

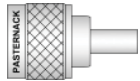
Connection Method	Product Image	Attachment Cable/Contact	Coax Type / Termination Type	Model No.	Price				ROW
					1-24	25-49	50-99	100 +	
<b>Male</b>									
Cable Connectors		Crimp/Solder	PE-C400, PE-B400, PE-B405, LMR-400, LMR-400-DB, LMR-400-UF, .400 inch	<a href="#">PE44470</a>	\$30.99	\$28.82	\$26.65	\$24.79	63
			RG58	<a href="#">PE44473</a>	\$24.87	\$23.13	\$21.39	\$19.90	64
			RG214, RG393	<a href="#">PE44474</a>	\$26.20	\$24.37	\$22.53	\$20.96	65

# N, 7mm, SC Torque Wrenches



Type	Bit Hex Size (in.)	Preset Torque (in.-lbs.)	Model No	1-24	25-49	50-99	100+	ROW
N, 7mm, SC	20 mm	14 in-lbs	<a href="#">PE5011-7</a>	\$288.75	\$268.54	\$248.33	\$231.00	
		8.1 in-lbs	<a href="#">PE5019-5</a>	\$215.82	\$200.71	\$185.61	\$172.66	
	3/4 inch	14 in-lbs	<a href="#">PE5019-4</a>	\$213.81	\$198.84	\$183.88	\$171.05	
		14 in-lbs	<a href="#">PE5019-8</a>	\$213.81	\$198.84	\$183.88	\$171.05	

# NMO Mount Connectors, [See Web](#) (2 parts available)

# QMA Connectors

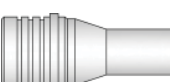
Connection Method	Product Image	Attachment Cable/Contact	Coax Type / Termination Type	Model No.	Price				ROW
					1-24	25-49	50-99	100 +	
<b>Male</b>									
Cable Connectors		Crimp/Solder	RG174, RG316, RG188, .100 inch, PE-B100, PE-C100, LMR-100	<a href="#">PE44501</a>	\$22.71	\$21.12	\$19.53	\$18.17	66
			PE-C195, PE-P195, RG58, RG141, RG303, LMR-195, .195 inch	<a href="#">PE44503</a>	\$18.79	\$17.47	\$16.16	\$15.03	67
			RG55, RG142, RG223, RG400	<a href="#">PE44514</a>	\$19.77	\$18.39	\$17.00	\$15.82	68
			LMR-200, PE-C200	<a href="#">PE45224</a>	\$10.84	\$10.08	\$9.32	\$8.67	69

\* Fits MIL-C-17 and equivalent cable versions only



Free Shipping Available via UPS Ground to USA & Canada



Technical Support (866) 727-8376









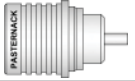

Same-Day Shipping, Even Custom Cable Assemblies

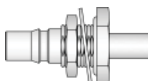

Connectors

See Our Website For Current Pricing & Real-Time Stock Availability!

# QMA Connectors

Connection Method	Product Image	Attachment Cable/Contact	Coax Type / Termination Type	Model No.	Price				ROW
					1-24	25-49	50-99	100 +	
<b>Male</b>									
Cable Connectors		Solder/Solder	PE-SR405AL, PE-SR405FL, RG405	<a href="#">PE44495</a>	\$20.03	\$18.63	\$17.23	\$16.02	70
			SPP-250-LLPL	<a href="#">PE45430</a>	\$20.84	\$19.38	\$17.92	\$16.67	71
		Solder/Non-Solder Contact	PE-SR402AL, PE-SR402FL, PE-SR402FLJ, PE-SR402TN, RG402	<a href="#">PE44496</a>	\$43.56	\$40.51	\$37.46	\$34.85	72
<b>Male Right Angle</b>									
Cable Connectors		Crimp/Solder	RG55, RG142, RG223, RG400	<a href="#">PE44515</a>	\$26.39	\$24.54	\$22.70	\$21.11	73
			RG174, RG316, RG188	<a href="#">PE45284</a>	\$20.41	\$18.98	\$17.55	\$16.33	74
		Solder/Solder	SPP-250-LLPL	<a href="#">PE45431</a>	\$22.93	\$21.32	\$19.72	\$18.34	75
		Crimp/Non-Solder Contact	LMR-240, PE-C240, LMR-240-UF	<a href="#">EZ-240-QM-RA-X</a>	\$19.50	\$19.50	\$19.50	\$19.50	76
<b>Female</b>									
Cable Connectors		Solder/Solder	SPP-250-LLPL	<a href="#">PE45429</a>	\$17.38	\$16.16	\$14.95	\$13.90	77
PCB Mount		Solder	Thru Hole	<a href="#">PE44512</a>	\$12.79	\$11.89	\$11.00	\$10.23	78
<b>Female, Bulkhead Mount</b>									
Cable Connectors		Crimp/Solder	RG174, RG316, RG188, .100 inch, PE-B100, PE-C100, LMR-100 with .268 inch D Hole	<a href="#">PE44507</a>	\$18.58	\$17.28	\$15.98	\$14.86	79
			RG58, RG141 with .268 inch D Hole	<a href="#">PE44509</a>	\$20.03	\$18.63	\$17.23	\$16.02	80
		Solder/Solder	PE-SR402AL, PE-SR402FL, PE-SR402FLJ, PE-SR402TN, RG402 with .268 inch D Hole	<a href="#">PE44500</a>	\$21.32	\$19.83	\$18.34	\$17.06	81
			PE-SR405AL, PE-SR405FL, RG405 with .268 inch D Hole	<a href="#">PE45218</a>	\$28.66	\$26.65	\$24.65	\$22.93	82

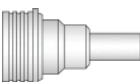

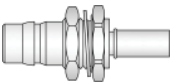
# QN Connectors

Connection Method	Product Image	Attachment Cable/Contact	Coax Type / Termination Type	Model No.	Price				ROW
					1-24	25-49	50-99	100 +	
<b>Male</b>									
Cable Connectors		Crimp/Solder	RG213, RG215	<a href="#">PE44597</a>	\$62.84	\$58.44	\$54.04	\$50.27	83
			LMR-240, PE-C240	<a href="#">PE45222</a>	\$30.19	\$28.08	\$25.96	\$24.15	84
<b>Male Right Angle</b>									
Cable Connectors		Crimp/Solder	RG55, RG141, RG142, RG223, RG400	<a href="#">PE44600</a>	\$39.03	\$36.30	\$33.57	\$31.22	85
			PE-C195, PE-P195, RG58, RG141, RG303, LMR-195, .195 inch	<a href="#">PE44601</a>	\$37.13	\$34.53	\$31.93	\$29.70	86
			LMR-400, PE-C400, LMR-400-DB	<a href="#">PE45223</a>	\$47.55	\$44.22	\$40.89	\$38.04	87
<b>Female, Bulkhead Mount</b>									
Cable Connectors		Crimp/Solder	.195 inch, RG58, RG141, RG303, LMR-195, LMR-195-FR, PE-C195, PE-P195 with .500 inch Diameter	<a href="#">PE44606</a>	\$40.62	\$37.78	\$34.93	\$32.50	88
			RG214, RG225 with .500 inch Diameter	<a href="#">PE44608</a>	\$93.92	\$87.35	\$80.77	\$75.14	89



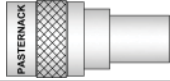
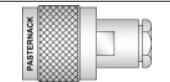

# RCA Connectors, [See Web](#) (9 parts available)

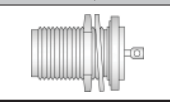
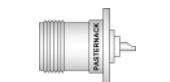
\* Fits MIL-C-17 and equivalent cable versions only

# SC Connectors

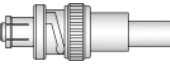
Connection Method	Product Image	Attachment Cable/Contact	Coax Type / Termination Type	Model No.	Price				ROW
					1-24	25-49	50-99	100 +	
<b>Male</b>									
Cable Connectors		Crimp/Solder	RG55, RG141, RG142, RG223, RG400	<a href="#">PE4231</a>	\$113.23	\$105.30	\$97.38	\$90.58	90
			RG214, RG9, RG225, RG393	<a href="#">PE4232</a>	\$61.37	\$57.07	\$52.78	\$49.10	91
		Clamp/Solder	RG213, RG214, RG8, RG9, RG225, RG393, RG215	<a href="#">PE4520</a>	\$160.20	\$148.99	\$137.77	\$128.16	92
<b>Male Right Angle</b>									
Cable Connectors		Clamp/Solder	RG58, RG55, RG141, RG142, RG223, RG400	<a href="#">PE4978</a>	\$129.39	\$120.33	\$111.28	\$103.51	93
			RG213, RG214, RG8, RG9, RG225, RG393, RG215	<a href="#">PE4979</a>	\$151.60	\$140.99	\$130.38	\$121.28	94
<b>Female, Bulkhead Mount</b>									
Terminal		Solder	Eyelet with .655 inch D Hole	<a href="#">PE4980</a>	\$36.85	\$34.27	\$31.69	\$29.48	95
<b>Female, 4 Hole Flange Mount</b>									
Terminal		Solder	Solder Cup with .718 inch Hole Spacing	<a href="#">PE4322</a>	\$37.20	\$34.60	\$31.99	\$29.76	96

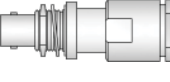
# SHV Connectors

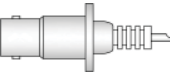
Connection Method	Product Image	Attachment Cable/Contact	Coax Type / Termination Type	Model No.	Price				ROW
					1-24	25-49	50-99	100 +	
<b>Plug</b>									
Cable Connectors		Crimp/Solder	RG58, RG303, RG141, PE-C195, PE-P195, LMR-195, .195 inch	<a href="#">PE4194</a>	\$41.45	\$38.55	\$35.65	\$33.16	97
			RG59*, RG62*, RG71	<a href="#">PE4343</a>	\$36.68	\$34.11	\$31.54	\$29.34	98
			RG214, RG9, RG225, RG393	<a href="#">PE4349</a>	\$35.18	\$32.72	\$30.25	\$28.14	99
			RG213, RG8	<a href="#">PE4496</a>	\$32.08	\$29.83	\$27.59	\$25.66	1
			RG55, RG141, RG142, RG223, RG400	<a href="#">PE4497</a>	\$32.08	\$29.83	\$27.59	\$25.66	2
			RG59*, RG62*, RG71	<a href="#">PE4100</a>	\$23.72	\$22.06	\$20.40	\$18.98	3
Cable Connectors		Clamp/Solder	RG58, RG55, RG141, RG142, RG223, RG400, RG303, PE-C195, PE-P195, LMR-195	<a href="#">PE4316</a>	\$23.66	\$22.00	\$20.35	\$18.93	4
			RG8, RG213, RG214	<a href="#">PE4333</a>	\$34.80	\$32.36	\$29.93	\$27.84	5
			RG174, RG316, RG188, LMR-100, PE-B100, PE-C100, .100 inch	<a href="#">PE4498</a>	\$36.51	\$33.95	\$31.40	\$29.21	6
			<b>Plug, Bulkhead Mount</b>						
Terminal		Solder	Solder Cup with .350 inch D Hole	<a href="#">PE44118</a>	\$45.32	\$42.15	\$38.98	\$36.26	7
<b>Jack, Bulkhead Mount</b>									
Cable Connectors		Clamp/Solder	RG59*, RG62*, RG71 with .480 inch D Hole	<a href="#">PE4315</a>	\$44.16	\$41.07	\$37.98	\$35.33	8
			RG213, RG214, RG8, RG9, RG225, RG393, RG215 with .480 inch D Hole	<a href="#">PE44049</a>	\$57.86	\$53.81	\$49.76	\$46.29	9
			RG58, RG142, RG223, RG400, RG141, RG303, RG55, LMR-400, PE-C195, PE-P195 with .480 inch D Hole	<a href="#">PE44080</a>	\$44.16	\$41.07	\$37.98	\$35.33	10
			RG174, RG316, RG188 with .480 inch D Hole	<a href="#">PE44093</a>	\$42.20	\$39.25	\$36.29	\$33.76	11
Terminal		Solder	Solder Cup with .350 inch D Hole	<a href="#">PE4239</a>	\$20.51	\$19.07	\$17.64	\$16.41	12
			Solder Cup with .480 inch D Hole	<a href="#">PE4499</a>	\$24.73	\$23.00	\$21.27	\$19.78	13
			Solder Cup with .350 inch D Hole	<a href="#">PE4500</a>	\$59.99	\$55.79	\$51.59	\$47.99	14
<b>Jack, 4 Hole Flange Mount</b>									
Terminal		Solder	Solder Cup with .500 inch Hole Spacing	<a href="#">PE4501</a>	\$34.03	\$31.65	\$29.27	\$27.22	15

\* Fits MIL-C-17 and equivalent cable versions only



Free Shipping Available via UPS Ground to USA & Canada



Technical Support (866) 727-8376









Same-Day Shipping, Even Custom Cable Assemblies

# SMA Connectors





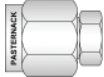



Connectors

See Our Website For Current Pricing & Real-Time Stock Availability!

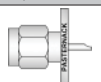
Connection Method	Product Image	Attachment Cable/Contact	Coax Type / Termination Type	Model No.	Price				ROW	
					1-24	25-49	50-99	100 +		
Cable Connectors	<b>Male</b>									
		Crimp/Crimp	RG174, RG316, RG188, LMR-100, PE-B100, PE-C100, .100 inch	<a href="#">PE4003</a>	\$10.37	\$9.64	\$8.92	\$8.30	16	
		Crimp/Solder	RG55, RG142, RG223, RG400, RG141	<a href="#">PE4008</a>	\$11.89	\$11.06	\$10.23	\$9.51	17	
			RG58, RG303, RG141, PE-C195, PE-P195, LMR-195, .195 inch	<a href="#">PE4215</a>	\$10.83	\$10.07	\$9.31	\$8.66	18	
			RG59*, RG62*, RG71	<a href="#">PE4294</a>	\$26.04	\$24.22	\$22.39	\$20.83	19	
			RG178, RG196	<a href="#">PE4398</a>	\$18.18	\$16.91	\$15.63	\$14.54	20	
			RG188-DS, RG316-DS	<a href="#">PE4401</a>	\$5.64	\$5.25	\$4.85	\$4.51	21	
			PE-P195	<a href="#">PE44203</a>	\$16.70	\$15.53	\$14.36	\$13.36	22	
			PE-C195, PE-P195, RG58, RG141, RG303, LMR-195, .195 inch	<a href="#">PE44460</a>	\$73.04	\$67.93	\$62.81	\$58.43	23	
			PE-C240, RG8X, .240 inch, LMR-240, LMR-240-DB, LMR-240-UF, B7808A	<a href="#">PE44637</a>	\$19.54	\$18.17	\$16.80	\$15.63	24	
			PE-C400, PE-B400, PE-B405, LMR-400, LMR-400-DB, LMR-400-UF, .400 inch	<a href="#">PE44668</a>	\$26.52	\$24.66	\$22.81	\$21.22	25	
			RG174, RG316, RG188	<a href="#">PE45145</a>	\$8.82	\$8.20	\$7.59	\$7.06	26	
			PE-B150, RG180, RG195	<a href="#">PE4578</a>	\$23.12	\$21.50	\$19.88	\$18.50	27	
			LMR-100, PE-C100, RG174, RG188, RG316	<a href="#">TC-100-SM</a>	\$12.44	\$12.44	\$12.44	\$12.44	28	
				<a href="#">TC-195-SM-SS-X</a>	\$15.74	\$15.74	\$15.74	\$15.74	29	
				<a href="#">TC-200-SM-SS-X</a>	\$14.56	\$14.56	\$14.56	\$14.56	30	
		<a href="#">TC-240-SM-SS-X</a>	\$9.81	\$9.81	\$9.81	\$9.81	31			
		<a href="#">TC-400-SM-X</a>	\$24.98	\$24.98	\$24.98	\$24.98	32			
		Crimp/Solder (Captive Contact)	RG55, RG141, RG142, RG223, RG400	<a href="#">PE4576</a>	\$24.06	\$22.38	\$20.69	\$19.25	33	
			RG58	<a href="#">PE4577</a>	\$20.20	\$18.79	\$17.37	\$16.16	34	
			RG174, RG316, RG188, LMR-100, PE-B100, PE-C100, .100 inch	<a href="#">PE4589</a>	\$17.17	\$15.97	\$14.77	\$13.74	35	
	PCB Mount		Clamp	Vertical Launch	<a href="#">PE45460</a>	\$37.61	\$34.98	\$32.34	\$30.09	36
				Vertical Launch	<a href="#">PE45461</a>	\$37.61	\$34.98	\$32.34	\$30.09	37
	Cable Connectors		Clamp/Solder	RG174, RG316, RG188, PE-B100, PE-C100, .100 inch, LMR-100	<a href="#">PE4026</a>	\$26.91	\$25.03	\$23.14	\$21.53	38
				RG55, RG58, RG141, RG142, RG223, RG303, RG400, PE-C195, PE-P195, LMR-195	<a href="#">PE4027</a>	\$26.59	\$24.73	\$22.87	\$21.27	39
				RG178, RG196	<a href="#">PE4214</a>	\$48.00	\$44.64	\$41.28	\$38.40	40
				RG213, RG214, RG8, RG9, RG11*, RG225, RG393, RG144*, RG216*, RG215	<a href="#">PE4332</a>	\$76.06	\$70.74	\$65.41	\$60.85	41
				RG180, RG195, PE-B150	<a href="#">PE4399</a>	\$21.58	\$20.07	\$18.56	\$17.26	42
				RG188-DS, RG316-DS	<a href="#">PE4400</a>	\$28.86	\$26.84	\$24.82	\$23.09	43
				RG316, RG174, LMR-100	<a href="#">PE45142</a>	\$14.46	\$13.45	\$12.44	\$11.57	44
				PE-P160LL	<a href="#">PE45440</a>	\$77.42	\$72.00	\$66.58	\$61.94	45
				PE-SR405AL, PE-SR405FL, RG405	<a href="#">PE4005</a>	\$7.43	\$6.91	\$6.39	\$5.94	46
				RG174, RG316, RG188, LMR-100, PE-B100, PE-C100, .100 inch	<a href="#">PE4036</a>	\$13.23	\$12.30	\$11.38	\$10.58	47
			Solder/Solder	RG58, RG55, RG142, RG223, RG400	<a href="#">PE4037</a>	\$14.56	\$13.54	\$12.52	\$11.65	48
				PE-SR402AL, PE-SR402FL, PE-SR402FLJ, PE-SR402TN, RG402	<a href="#">PE4112</a>	\$9.37	\$8.71	\$8.06	\$7.50	49
				RG178, RG196	<a href="#">PE4213</a>	\$17.10	\$15.90	\$14.71	\$13.68	50
RG188-DS, RG316-DS				<a href="#">PE4402</a>	\$15.21	\$14.15	\$13.08	\$12.17	51	
PE-047SR, PE-SR047AL, PE-SR047FL				<a href="#">PE4404</a>	\$25.96	\$24.14	\$22.33	\$20.77	52	
PE-SR405AL, PE-SR405FL, PE-SR405FLJ, PE-SR405TN, RG405				<a href="#">PE44690</a>	\$9.53	\$8.86	\$8.20	\$7.62	53	
PE-047SR, PE-SR047AL, PE-SR047FL				<a href="#">PE44757</a>	\$33.60	\$31.25	\$28.90	\$26.88	54	
RG405, PE-SR405FL, PE-SR405FLJ				<a href="#">PE45135</a>	\$7.04	\$6.55	\$6.05	\$5.63	55	
SPP-250-LLPL				<a href="#">PE45433</a>	\$13.89	\$12.92	\$11.95	\$11.11	56	
PE-SR401AL, PE-SR401FL, RG401				<a href="#">PE4907</a>	\$40.01	\$37.21	\$34.41	\$32.01	57	
	Solder (Without Contact)	PE-SR402AL, PE-SR402FL, PE-SR402FLJ, PE-SR402TN, RG402	<a href="#">PE4007</a>	\$8.79	\$8.17	\$7.56	\$7.03	60		
		PE-SR402AL, PE-SR402FL, PE-SR402FLJ, PE-SR402TN, RG402	<a href="#">PE44691</a>	\$8.72	\$8.11	\$7.50	\$6.98	61		

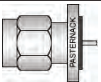
\* Fits MIL-C-17 and equivalent cable versions only

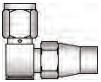
# SMA Connectors

Connection Method	Product Image	Attachment Cable/Contact	Coax Type / Termination Type	Model No.	Price				ROW
					1-24	25-49	50-99	100 +	
<b>Male</b>									
PCB Mount		Solder	Thru Hole with .200 inch x .067 inch Hole Spacing	<a href="#">PE4525</a>	\$21.17	\$19.69	\$18.21	\$16.94	62
			.062 inch End Launch	<a href="#">PE4912</a>	\$29.05	\$27.02	\$24.98	\$23.24	63
			.062 inch End Launch	<a href="#">PE4913</a>	\$29.29	\$27.24	\$25.19	\$23.43	64
Cable Connectors		Crimp/Non-Solder Contact	LMR-240, PE-C240	<a href="#">EZ-240-SM-X</a>	\$9.14	\$9.14	\$9.14	\$9.14	65
<b>Male, Bulkhead Mount</b>									
Terminal		Solder	Solder Cup with .235 inch D Hole	<a href="#">PE4354</a>	\$18.19	\$16.92	\$15.64	\$14.55	66
<b>Male, 2 Hole Flange Mount</b>									
Terminal		Solder	Stub with .481 inch Hole Spacing	<a href="#">PE4127</a>	\$13.83	\$12.86	\$11.89	\$11.06	67
Field Replaceable		Field Replaceable	.018 inch Pin	<a href="#">PE44030</a>	\$37.73	\$35.09	\$32.45	\$30.18	68
<b>Male, 4 Hole Flange Mount</b>									
Terminal		Solder	Stub with .340 inch Hole Spacing	<a href="#">PE4126</a>	\$23.93	\$22.25	\$20.58	\$19.14	69
			Solder Cup with .340 inch Hole Spacing	<a href="#">PE45204</a>	\$44.47	\$41.36	\$38.24	\$35.58	70
			Pin with .340 inch Hole Spacing	<a href="#">PE4541</a>	\$48.46	\$45.07	\$41.68	\$38.77	71
<b>Male Right Angle</b>									
Cable Connectors		Crimp/Solder	RG55, RG142, RG223, RG400, RG141	<a href="#">PE4002</a>	\$17.29	\$16.08	\$14.87	\$13.83	72
			RG174, RG316, RG188, LMR-100, PE-B100, PE-C100, .100 inch	<a href="#">PE4009</a>	\$20.44	\$19.01	\$17.58	\$16.35	73
			RG178, RG196	<a href="#">PE4296</a>	\$26.78	\$24.91	\$23.03	\$21.42	74
			RG59*, RG62*, RG71	<a href="#">PE4327</a>	\$31.60	\$29.39	\$27.18	\$25.28	75
			RG58, RG303, RG141, PE-C195, PE-P195, LMR-195, .195 inch	<a href="#">PE4405</a>	\$11.23	\$10.44	\$9.66	\$8.98	76
			RG188-DS, RG316-DS	<a href="#">PE4408</a>	\$19.17	\$17.83	\$16.49	\$15.34	77
		Clamp/Solder	PE-C240, RG8X, .240 inch, LMR-240, LMR-240-DB, LMR-240-UF, B7808A	<a href="#">PE44638</a>	\$26.81	\$24.93	\$23.06	\$21.45	78
			RG174, RG316, RG188, .100 inch, PE-B100, PE-C100, LMR-100	<a href="#">PE4028</a>	\$30.70	\$28.55	\$26.40	\$24.56	79
			RG188-DS, RG316-DS	<a href="#">PE4407</a>	\$34.86	\$32.42	\$29.98	\$27.89	80
			PE-SR402AL, PE-SR402FL, PE-SR402FLJ, PE-SR402TN, RG402	<a href="#">PE44996</a>	\$82.56	\$76.78	\$71.00	\$66.05	81
			RG58, RG55, RG141, RG142, RG223, RG303, RG400, LMR-195, PE-C195	<a href="#">PE45048</a>	\$47.31	\$44.00	\$40.69	\$37.85	82
			PE-P160LL	<a href="#">PE45442</a>	\$113.13	\$105.21	\$97.29	\$90.50	83
		Solder/Solder	PE-SR405AL, PE-SR405FL, RG405	<a href="#">PE4025</a>	\$28.47	\$26.48	\$24.48	\$22.78	84
			RG316, RG174, RG188, LMR-100, PE-B100, PE-C100, .100 inch	<a href="#">PE4038</a>	\$18.49	\$17.20	\$15.90	\$14.79	85
			RG58, RG55, RG142, RG223, RG400	<a href="#">PE4039</a>	\$17.10	\$15.90	\$14.71	\$13.68	86
			PE-SR402AL, PE-SR402FL, PE-SR402FLJ, PE-SR402TN, RG402	<a href="#">PE4083</a>	\$20.41	\$18.98	\$17.55	\$16.33	87
			RG178, RG196	<a href="#">PE4406</a>	\$22.81	\$21.21	\$19.62	\$18.25	88
			RG188-DS, RG316-DS	<a href="#">PE4409</a>	\$21.37	\$19.87	\$18.38	\$17.10	89
			PE-SR405AL, PE-SR405FL, PE-SR405FLJ, PE-SR405TN, RG405	<a href="#">PE44692</a>	\$11.57	\$10.76	\$9.95	\$9.26	90
			PE-SR402AL, PE-SR402FL, PE-SR402FLJ, PE-SR402TN, RG402	<a href="#">PE44693</a>	\$11.16	\$10.38	\$9.60	\$8.93	91
			PE-047SR, PE-SR047AL, PE-SR047FL	<a href="#">PE45282</a>	\$54.99	\$51.14	\$47.29	\$43.99	92
			SPP-250-LLPL	<a href="#">PE45434</a>	\$15.29	\$14.22	\$13.15	\$12.23	93
			PE-034SR	<a href="#">PE4919</a>	\$53.88	\$50.11	\$46.34	\$43.10	94
			PE-020SR	<a href="#">PE4920</a>	\$59.76	\$55.58	\$51.39	\$47.81	95
PCB Mount		Solder	Thru Hole with .200 inch x .067 inch Hole Spacing	<a href="#">PE4526</a>	\$36.20	\$33.67	\$31.13	\$28.96	97

Connectors

See Our Website For Current Pricing & Real-Time Stock Availability!

\* Fits MIL-C-17 and equivalent cable versions only



Free Shipping Available via UPS Ground to USA & Canada











Technical Support (866) 727-8376



Same-Day Shipping, Even Custom Cable Assemblies

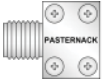

# SMA Connectors













Connection Method	Product Image	Attachment Cable/Contact	Coax Type / Termination Type	Model No.	Price				ROW			
					1-24	25-49	50-99	100 +				
Cable Connectors	<b>Male Right Angle</b>											
		Crimp/Non-Solder Contact	LMR-240	<a href="#">EZ-240-SM-RA-X</a>	\$13.09	\$13.09	\$13.09	\$13.09	98			
Cable Connectors	<b>Female</b>											
		Crimp/Solder	RG178, RG196	<a href="#">PE4325</a>	\$26.59	\$24.73	\$22.87	\$21.27	99			
			RG55, RG142, RG223, RG400, RG141	<a href="#">PE4412</a>	\$15.95	\$14.83	\$13.72	\$12.76	1			
			RG58	<a href="#">PE4413</a>	\$17.90	\$16.65	\$15.39	\$14.32	2			
			RG174, RG316, RG188, .100 inch, PE-B100, PE-C100, LMR-100	<a href="#">PE4414</a>	\$19.86	\$18.47	\$17.08	\$15.89	3			
			RG188-DS, RG316-DS	<a href="#">PE4416</a>	\$17.90	\$16.65	\$15.39	\$14.32	4			
			PE-C240, RG8X, .240 inch, LMR-240, LMR-240-DB, LMR-240-UF, B7808A	<a href="#">PE44639</a>	\$22.43	\$20.86	\$19.29	\$17.94	5			
			PE-C400, PE-B400, PE-B405, LMR-400, LMR-400-DB, LMR-400-UF, .400 inch	<a href="#">PE44669</a>	\$43.25	\$40.22	\$37.20	\$34.60	6			
			RG316, RG174, LMR-100	<a href="#">PE45137</a>	\$8.79	\$8.17	\$7.56	\$7.03	7			
Vertical Launch			<a href="#">PE45458</a>	\$35.15	\$32.69	\$30.23	\$28.12	8				
PCB Mount		Clamp	Vertical Launch	<a href="#">PE45459</a>	\$35.15	\$32.69	\$30.23	\$28.12	9			
Cable Connectors		Clamp/Solder	RG55, RG58, RG141, RG142, RG223, RG303, RG400, PE-C195, PE-P195, LMR-195	<a href="#">PE4031</a>	\$40.37	\$37.54	\$34.72	\$32.30	10			
			RG213, RG214, RG8, RG9, RG11*, RG225, RG393	<a href="#">PE4411</a>	\$56.47	\$52.52	\$48.56	\$45.18	11			
PCB Mount		Clamp/Solder (Captive Contact)	PE-P142LL	<a href="#">PE44814</a>	\$60.73	\$56.48	\$52.23	\$48.58	12			
			End Launch	<a href="#">PE45462</a>	\$50.06	\$46.56	\$43.05	\$40.05	13			
			End Launch	<a href="#">PE45463</a>	\$50.06	\$46.56	\$43.05	\$40.05	14			
			End Launch	<a href="#">PE45464</a>	\$50.06	\$46.56	\$43.05	\$40.05	15			
			End Launch	<a href="#">PE45465</a>	\$50.06	\$46.56	\$43.05	\$40.05	16			
Cable Connectors		Solder/Solder	RG316, RG174, RG188	<a href="#">PE4040</a>	\$14.21	\$13.22	\$12.22	\$11.37	18			
			RG58, RG55, RG142, RG223, RG400	<a href="#">PE4041</a>	\$15.63	\$14.54	\$13.44	\$12.50	19			
			PE-SR402AL, PE-SR402FL, PE-SR402FLJ, PE-SR402TN, RG402	<a href="#">PE4115</a>	\$14.69	\$13.66	\$12.63	\$11.75	20			
			PE-SR405AL, PE-SR405FL, PE-SR405FLJ, RG405	<a href="#">PE4116</a>	\$22.88	\$21.28	\$19.68	\$18.30	21			
			PE-047SR, PE-SR047AL, PE-SR047FL	<a href="#">PE4418</a>	\$34.72	\$32.29	\$29.86	\$27.78	22			
			PE-SR405AL, PE-SR405FL, PE-SR405FLJ, PE-SR405TN, RG405	<a href="#">PE44694</a>	\$8.20	\$7.63	\$7.05	\$6.56	23			
			PE-SR402AL, PE-SR402FL, PE-SR402FLJ, PE-SR402TN, RG402	<a href="#">PE44695</a>	\$8.20	\$7.63	\$7.05	\$6.56	24			
			SPP-250-LLPL	<a href="#">PE45432</a>	\$14.59	\$13.57	\$12.55	\$11.67	25			
			RG178, RG196	<a href="#">PE4592</a>	\$21.42	\$19.92	\$18.42	\$17.14	26			
			PE-034SR	<a href="#">PE4921</a>	\$53.88	\$50.11	\$46.34	\$43.10	27			
			PE-020SR	<a href="#">PE4922</a>	\$58.70	\$54.59	\$50.48	\$46.96	28			
			PE-SR401AL, PE-SR401FL, RG401	<a href="#">PE4930</a>	\$24.93	\$23.18	\$21.44	\$19.94	29			
			PCB Mount		Solder/Solder (Captive Contact)	1/8 inch Stripline	<a href="#">PE4190</a>	\$44.81	\$41.67	\$38.54	\$35.85	30
						1/16 inch Stripline	<a href="#">PE4534</a>	\$42.59	\$39.61	\$36.63	\$34.07	31
					Solder	Thru Hole with .200 inch x .067 inch Hole Spacing	<a href="#">PE4117</a>	\$13.06	\$12.15	\$11.23	\$10.45	32
						.042 inch End Launch	<a href="#">PE44204</a>	\$22.65	\$21.06	\$19.48	\$18.12	33
						.047 inch End Launch	<a href="#">PE44205</a>	\$25.89	\$24.08	\$22.27	\$20.71	34
.031 inch End Launch	<a href="#">PE44206</a>	\$18.63				\$17.33	\$16.02	\$14.90	35			
.042 inch End Launch	<a href="#">PE44207</a>	\$24.17				\$22.48	\$20.79	\$19.34	36			
.047 inch End Launch	<a href="#">PE44208</a>	\$25.16				\$23.40	\$21.64	\$20.13	37			
End Launch	<a href="#">PE44235</a>	\$20.43				\$19.00	\$17.57	\$16.34	38			
Thru Hole with .200 inch x .067 inch Hole Spacing	<a href="#">PE44342</a>	\$50.20				\$46.69	\$43.17	\$40.16	39			
.078 inch End Launch	<a href="#">PE44614</a>	\$30.87	\$28.71	\$26.55	\$24.70	40						
Thru Hole with .200 inch x .067 inch Hole Spacing	<a href="#">PE44827</a>	\$9.49	\$8.83	\$8.16	\$7.59	41						
.062 inch End Launch	<a href="#">PE4542</a>	\$18.03	\$16.77	\$15.51	\$14.42	42						
.062 inch End Launch	<a href="#">PE4543</a>	\$18.43	\$17.14	\$15.85	\$14.74	43						
Surface Mount	<a href="#">PE4910</a>	\$16.36	\$15.21	\$14.07	\$13.09	44						
Cable Connectors	<b>Female, Bulkhead Mount</b>											
		Crimp/Solder	RG55, RG142, RG223, RG400, RG141 with .235 inch D Hole	<a href="#">PE4419</a>	\$20.03	\$18.63	\$17.23	\$16.02	45			
			RG58 with .235 inch D Hole	<a href="#">PE4420</a>	\$17.42	\$16.20	\$14.98	\$13.94	46			
			RG316, RG174, RG188, PE-B100, PE-C100, .100 inch, LMR-100 with .235 inch D Hole	<a href="#">PE4427</a>	\$15.89	\$14.78	\$13.67	\$12.71	47			
			RG174, RG316, RG188, .100 inch, PE-B100, PE-C100, LMR-100 with .235 inch D Hole	<a href="#">PE44643</a>	\$22.52	\$20.94	\$19.37	\$18.02	48			
RG316, RG174, LMR-100			<a href="#">PE45136</a>	\$12.05	\$11.21	\$10.36	\$9.64	49				

\* Fits MIL-C-17 and equivalent cable versions only

Connectors

See Our Website For Current Pricing & Real-Time Stock Availability!

# SMA Connectors

Connection Method	Product Image	Attachment Cable/Contact	Coax Type / Termination Type	Model No.	Price				ROW
					1-24	25-49	50-99	100 +	
<b>Female, Bulkhead Mount</b>									
Cable Connectors		Crimp/Solder	RG58, RG303, LMR-195, PE-P195	<a href="#">PE45141</a>	\$12.48	\$11.61	\$10.73	\$9.98	50
			RG178, RG196 with .235 inch D Hole	<a href="#">PE45292</a>	\$19.75	\$18.37	\$16.99	\$15.80	51
PCB Mount			Thru Hole	<a href="#">PE45134</a>	\$23.25	\$21.62	\$20.00	\$18.60	52
Cable Connectors		Clamp/Solder	RG188-DS, RG316-DS with .235 inch D Hole	<a href="#">PE4424</a>	\$37.59	\$34.96	\$32.33	\$30.07	53
			PE-P160LL	<a href="#">PE45441</a>	\$93.78	\$87.22	\$80.65	\$75.02	54
Cable Connectors		Solder/Solder	PE-SR405AL, PE-SR405FL, RG405 with .235 inch D Hole	<a href="#">PE4119</a>	\$12.37	\$11.50	\$10.64	\$9.90	55
			PE-SR402AL, PE-SR402FL, PE-SR402FLJ, PE-SR402TN, RG402 with .235 inch D Hole	<a href="#">PE4120</a>	\$15.08	\$14.02	\$12.97	\$12.06	56
			RG316, RG174, RG188 with .235 inch D Hole	<a href="#">PE4188</a>	\$17.10	\$15.90	\$14.71	\$13.68	57
			RG58, RG55, RG142, RG223, RG400 with .235 inch D Hole	<a href="#">PE4353</a>	\$17.53	\$16.30	\$15.08	\$14.02	58
Cable Connectors		Solder/Solder	PE-SR405AL, PE-SR405FL, PE-SR405FLJ, PE-SR405TN, RG405	<a href="#">PE44696</a>	\$11.90	\$11.07	\$10.23	\$9.52	59
			.042 inch End Launch with .250 inch Diameter	<a href="#">PE44211</a>	\$24.56	\$22.84	\$21.12	\$19.65	60
			.062 inch End Launch with .250 inch Diameter	<a href="#">PE44212</a>	\$24.11	\$22.42	\$20.73	\$19.29	61
			.062 inch End Launch with .250 inch Diameter	<a href="#">PE44214</a>	\$24.11	\$22.42	\$20.73	\$19.29	62
Terminal		Solder	Thru Hole with .235 inch D Hole	<a href="#">PE4524</a>	\$17.64	\$16.41	\$15.17	\$14.11	63
			Solder Cup with .235 inch D Hole	<a href="#">PE4101</a>	\$16.33	\$15.19	\$14.04	\$13.06	64
			Stub with .250 inch Diameter	<a href="#">PE4189</a>	\$14.43	\$13.42	\$12.41	\$11.54	65
			Solder Cup with .235 inch D Hole	<a href="#">PE4219</a>	\$13.01	\$12.10	\$11.19	\$10.41	66
			Stub with .250 inch Diameter	<a href="#">PE44591</a>	\$26.52	\$24.66	\$22.81	\$21.22	67
			Stub with .235 inch D Hole	<a href="#">PE4528</a>	\$32.49	\$30.22	\$27.94	\$25.99	68
			Solder Cup with .235 inch D Hole	<a href="#">PE4529</a>	\$24.43	\$22.72	\$21.01	\$19.54	69
			Stub with .250 inch Diameter	<a href="#">PE4530</a>	\$31.71	\$29.49	\$27.27	\$25.37	70
			Stub with .250 inch Diameter	<a href="#">PE4532</a>	\$25.92	\$24.11	\$22.29	\$20.74	71
			Solder Cup with .350 inch D Hole	<a href="#">PE4536</a>	\$37.60	\$34.97	\$32.34	\$30.08	72
			Solder Cup with .250 inch Diameter	<a href="#">PE4549</a>	\$25.40	\$23.62	\$21.84	\$20.32	73
			<b>Female, 2 Hole Flange Mount</b>						
Cable Connectors		Solder/Solder	PE-SR402AL, PE-SR402FL, RG402 with .481 inch Hole Spacing	<a href="#">PE4196</a>	\$26.19	\$24.36	\$22.52	\$20.95	74
			PE-SR405AL, PE-SR405FL, PE-SR405FLJ, RG405 with .481 inch Hole Spacing	<a href="#">PE4197</a>	\$22.45	\$20.88	\$19.31	\$17.96	75
			PE-047SR, PE-SR047AL, PE-SR047FL with .481 inch Hole Spacing	<a href="#">PE4547</a>	\$26.05	\$24.23	\$22.40	\$20.84	76
Terminal		Solder	Solder Cup with .481 inch Hole Spacing	<a href="#">PE4004</a>	\$15.27	\$14.20	\$13.13	\$12.22	77
			Stub with .481 inch Hole Spacing	<a href="#">PE4128</a>	\$17.85	\$16.60	\$15.35	\$14.28	78
			Stub with .481 inch Hole Spacing	<a href="#">PE4128-SF</a>	Call	Call	Call	Call	79
			Solder Cup with .481 inch Hole Spacing	<a href="#">PE44341</a>	\$54.33	\$50.53	\$46.72	\$43.46	80
			Stub with .481 inch Hole Spacing	<a href="#">PE44343</a>	\$51.13	\$47.55	\$43.97	\$40.90	81
			Stub	<a href="#">PE45039</a>	\$12.11	\$11.26	\$10.41	\$9.69	82
Field Replaceable		Field Replaceable	.015 inch Pin	<a href="#">PE44024</a>	\$31.98	\$29.74	\$27.50	\$25.58	84
			.018 inch Pin	<a href="#">PE44025</a>	\$32.74	\$30.45	\$28.16	\$26.19	85
			.020 inch Pin	<a href="#">PE45054</a>	\$27.06	\$25.17	\$23.27	\$21.65	86
			.036 inch Pin	<a href="#">PE45055</a>	\$27.49	\$25.57	\$23.64	\$21.99	87
Terminal		Compression	Stub with .481 inch Hole Spacing	<a href="#">PE44340</a>	\$60.88	\$56.62	\$52.36	\$48.70	88
<b>Female, 4 Hole Flange Mount</b>									
Cable Connectors		Solder/Solder	RG402, RG402 Tinned, PE-SR402FL, PE-SR402AL, PE-SR402FLJ, PE-SR402TN with .340 inch Hole Spacing	<a href="#">PE4121</a>	\$33.39	\$31.05	\$28.72	\$26.71	89
			RG405, RG405 Tinned, PE-SR405FL, PE-SR405AL, PE-SR405FLJ, PE-SR405TN	<a href="#">PE44998</a>	\$29.51	\$27.44	\$25.38	\$23.61	90
Terminal		Solder	Solder Cup with .340 inch Hole Spacing	<a href="#">PE4000</a>	\$20.13	\$18.72	\$17.31	\$16.10	91
			Stub with .340 inch Hole Spacing	<a href="#">PE4099</a>	\$16.02	\$14.90	\$13.78	\$12.82	92
			Tab with .340 inch Hole Spacing	<a href="#">PE4186</a>	\$17.13	\$15.93	\$14.73	\$13.70	93
			Pin with .340 inch Hole Spacing	<a href="#">PE4217</a>	\$22.74	\$21.15	\$19.56	\$18.19	94
			Solder Cup with .718 inch Hole Spacing	<a href="#">PE4218</a>	\$24.38	\$22.67	\$20.97	\$19.50	95
			Stub with .500 inch Hole Spacing	<a href="#">PE4533</a>	\$23.66	\$22.00	\$20.35	\$18.93	96
Pin with .340 inch Hole Spacing	<a href="#">PE4540</a>	\$45.96	\$42.74	\$39.53	\$36.77	97			

Connectors

See Our Website For Current Pricing & Real-Time Stock Availability!

\* Fits MIL-C-17 and equivalent cable versions only



Free Shipping Available via UPS Ground to USA & Canada









Technical Support (866) 727-8376



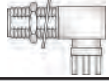



Same-Day Shipping, Even Custom Cable Assemblies

# SMA Connectors

Connection Method	Product Image	Attachment Cable/Contact	Coax Type / Termination Type	Model No.	Price				ROW
					1-24	25-49	50-99	100 +	
<b>Female, 4 Hole Flange Mount</b>									
Field Replaceable		Field Replaceable	.020 inch Pin	<a href="#">PE44003</a>	\$31.90	\$29.67	\$27.43	\$25.52	98
			.036 inch Pin	<a href="#">PE44004</a>	\$34.11	\$31.72	\$29.33	\$27.29	99
			.020 inch Pin	<a href="#">PE45215</a>	\$17.57	\$16.34	\$15.11	\$14.06	1
			.015 inch Pin	<a href="#">PE45216</a>	\$16.36	\$15.21	\$14.07	\$13.09	2
<b>Female, Press-In</b>									
Terminal		Solder	Tab with .200 inch Diameter	<a href="#">PE44241</a>	\$30.61	\$28.47	\$26.32	\$24.49	3
<b>Female Right Angle</b>									
PCB Mount		Solder	Thru Hole with .200 inch x .067 inch Hole Spacing	<a href="#">PE4118</a>	\$18.98	\$17.65	\$16.32	\$15.18	4
			Surface Mount	<a href="#">PE4911</a>	\$25.20	\$23.44	\$21.67	\$20.16	5
<b>Female Right Angle, Bulkhead Mount</b>									
PCB Mount		Solder	Thru Hole with .235 inch D Hole	<a href="#">PE4545</a>	\$27.78	\$25.84	\$23.89	\$22.22	6
<b>Female Right Angle, 2 Hole Flange Mount</b>									
Terminal		Solder	Pin with .481 inch Hole Spacing	<a href="#">PE44237</a>	\$51.38	\$47.78	\$44.19	\$41.10	7
			Pin with .481 inch Hole Spacing	<a href="#">PE44238</a>	\$45.66	\$42.46	\$39.27	\$36.53	8
			Pin with .481 inch Hole Spacing	<a href="#">PE44239</a>	\$44.61	\$41.49	\$38.36	\$35.69	9
			Pin with .481 inch Hole Spacing	<a href="#">PE44593</a>	\$45.66	\$42.46	\$39.27	\$36.53	10
<b>Female Right Angle, 4 Hole Flange Mount</b>									
Terminal		Solder	Solder Cup with .340 inch Hole Spacing	<a href="#">PE4123</a>	\$36.89	\$34.31	\$31.73	\$29.51	11
			Pin with .340 inch Hole Spacing	<a href="#">PE44236</a>	\$30.61	\$28.47	\$26.32	\$24.49	12
Field Replaceable		Field Replaceable	.018 inch Pin	<a href="#">PE44017</a>	\$66.46	\$61.81	\$57.16	\$53.17	13

# Reverse Polarity SMA Connectors







Connection Method	Product Image	Attachment Cable/Contact	Coax Type / Termination Type	Model No.	Price				ROW
					1-24	25-49	50-99	100 +	
<b>Male</b>									
Cable Connectors		Crimp/Solder	PE-C240, RG8X, .240 inch, LMR-240, LMR-240-DB, LMR-240-UF, B7808A	<a href="#">PE44664</a>	\$24.89	\$23.15	\$21.41	\$19.91	14
			PE-C400, PE-B400, PE-B405, LMR-400, LMR-400-DB, LMR-400-UF, .400 inch	<a href="#">PE44666</a>	\$24.72	\$22.99	\$21.26	\$19.78	15
			RG55, RG141, RG142, RG223, RG400	<a href="#">PE4767</a>	\$19.80	\$18.41	\$17.03	\$15.84	16
			RG58	<a href="#">PE4769</a>	\$20.63	\$19.19	\$17.74	\$16.50	17
			RG174, RG316, RG188, PE-B100, PE-C100, .100 inch, LMR-100	<a href="#">PE4771</a>	\$18.79	\$17.47	\$16.16	\$15.03	18
Cable Connectors		Clamp/Solder	RG55, RG58, RG141, RG142, RG223, RG303, RG400, PE-C195, PE-P195, LMR-195	<a href="#">PE4766</a>	\$32.44	\$30.17	\$27.90	\$25.95	19
			PE-SR405AL, PE-SR405FL, RG405	<a href="#">PE4779</a>	\$24.38	\$22.67	\$20.97	\$19.50	20
<b>Male Right Angle</b>									
Cable Connectors		Crimp/Solder	RG58, RG141, PE-C195, PE-P195	<a href="#">PE45012</a>	Call	Call	Call	Call	21
			RG174, RG316, RG188, PE-B100, PE-C100, .100 inch, LMR-100	<a href="#">PE4785</a>	\$49.41	\$45.95	\$42.49	\$39.53	22
			RG55, RG141, RG142, RG223, RG400	<a href="#">PE44975</a>	\$35.58	\$33.09	\$30.60	\$28.46	23
			RG58, RG55, RG141, RG142, RG223, RG400	<a href="#">PE4782</a>	\$33.83	\$31.46	\$29.09	\$27.06	24
Cable Connectors		Solder/Solder	RG174, RG316, RG188	<a href="#">PE4786</a>	\$33.83	\$31.46	\$29.09	\$27.06	25

\* Fits MIL-C-17 and equivalent cable versions only



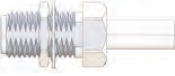

Connectors

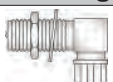
See Our Website For Current Pricing & Real-Time Stock Availability!

# Reverse Polarity SMA Connectors

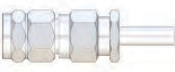
Connection Method	Product Image	Attachment Cable/Contact	Coax Type / Termination Type	Model No.	Price				ROW
					1-24	25-49	50-99	100 +	
<b>Female</b>									
Cable Connectors		Crimp/Solder	PE-C240, RG8X, .240 inch, LMR-240, LMR-240-DB, LMR-240-UF, B7808A	<a href="#">PE44665</a>	\$26.77	\$24.90	\$23.02	\$21.42	26
			RG188-DS, RG316-DS	<a href="#">PE45186</a>	\$26.00	\$24.18	\$22.36	\$20.80	27
			RG58	<a href="#">PE4795</a>	\$24.87	\$23.13	\$21.39	\$19.90	28
PCB Mount		Solder	Thru Hole with .200 inch x .067 inch Hole Spacing	<a href="#">PE4869</a>	\$21.93	\$20.39	\$18.86	\$17.54	29
<b>Female, Bulkhead Mount</b>									
Cable Connectors		Crimp/Solder	RG196, RG178	<a href="#">PE45004</a>	\$13.05	\$12.14	\$11.22	\$10.44	30
			.100 inch, RG316, RG174, RG188, LMR-100, LMR-100A, LMR-100A-FR, PE-C100, PE-B100 with .235 inch D Hole	<a href="#">PE4859</a>	\$26.07	\$24.25	\$22.42	\$20.86	31
		Clamp/Solder	RG174, RG316, RG188 with .235 inch D Hole	<a href="#">PE4858</a>	\$37.73	\$35.09	\$32.45	\$30.18	32
		Solder/Solder	PE-SR405AL, PE-SR405FL, PE-SR405FLJ, PE-SR405TN, RG405 with .235 inch D Hole	<a href="#">PE4865</a>	\$35.85	\$33.34	\$30.83	\$28.68	33
<b>Female, 2 Hole Flange Mount</b>									
Terminal		Solder	Solder Cup with .481 inch Hole Spacing	<a href="#">PE4867</a>	\$26.11	\$24.28	\$22.45	\$20.89	34
<b>Female Right Angle</b>									
PCB Mount		Solder	Thru Hole with .200 inch x .067 inch Hole Spacing	<a href="#">PE4870</a>	\$32.59	\$30.31	\$28.03	\$26.07	35
<b>Female Right Angle, Bulkhead Mount</b>									
PCB Mount		Solder	Thru Hole with .250 inch Diameter	<a href="#">PE4875</a>	\$43.64	\$40.59	\$37.53	\$34.91	36

# Reverse Thread SMA Connectors

Connection Method	Product Image	Attachment Cable/Contact	Coax Type / Termination Type	Model No.	Price				ROW
					1-24	25-49	50-99	100 +	
<b>Male</b>									
Cable Connectors		Crimp/Solder	RG178, RG196	<a href="#">PE44185</a>	\$24.38	\$22.67	\$20.97	\$19.50	37
<b>Male Right Angle</b>									
Cable Connectors		Crimp/Solder	RG174, RG316, RG188	<a href="#">PE44188</a>	\$42.39	\$39.42	\$36.46	\$33.91	38
<b>Female</b>									
Cable Connectors		Crimp/Solder	RG174, RG316, RG188	<a href="#">PE44192</a>	\$25.64	\$23.85	\$22.05	\$20.51	39
PCB Mount		Solder	Thru Hole with .200 inch x .067 inch Hole Spacing	<a href="#">PE44198</a>	\$27.69	\$25.75	\$23.81	\$22.15	40
			.062 inch End Launch	<a href="#">PE44201</a>	\$27.69	\$25.75	\$23.81	\$22.15	41
			.062 inch End Launch	<a href="#">PE44202</a>	\$27.69	\$25.75	\$23.81	\$22.15	42
<b>Female, Bulkhead Mount</b>									
Cable Connectors		Crimp/Solder	.100 inch, RG316, RG174, RG188, LMR-100, LMR-100A, LMR-100A-FR, PE-C100, PE-B100 with .235 inch D Hole	<a href="#">PE44196</a>	\$19.98	\$18.58	\$17.18	\$15.98	43

\* Fits MIL-C-17 and equivalent cable versions only



Free Shipping Available  
via UPS Ground to  
USA & Canada



Technical Support  
(866) 727-8376



Same-Day Shipping,  
Even Custom  
Cable Assemblies

Connectors

See Our Website For Current Pricing & Real-Time Stock Availability!

# SMA, 2.92mm Torque Wrenches



Type	Bit Hex Size (in.)	Preset Torque (in.-lbs.)	Model No	1-24	25-49	50-99	100+	ROW
SMA, 2.92mm	5/16 inch	5 in-lbs	<a href="#">PE5019-19</a>	\$211.79	\$196.96	\$182.14	\$169.43	
		8 in-lbs	<a href="#">PE5011-1</a>	\$213.26	\$198.33	\$183.40	\$170.61	

## SMB Connectors





Connection Method	Product Image	Attachment Cable/Contact	Coax Type / Termination Type	Model No.	Price				ROW
					1-24	25-49	50-99	100 +	
Cable Connectors	<b>Plug</b>								
		Crimp/Solder	RG174, RG316, RG188, LMR-100, PE-B100, PE-C100, .100 inch	<a href="#">PE4046</a>	\$12.10	\$11.25	\$10.41	\$9.68	44
			RG178, RG196	<a href="#">PE4080</a>	\$16.52	\$15.36	\$14.21	\$13.22	45
			RG316-DS, RG188-DS	<a href="#">PE44792</a>	\$13.02	\$12.11	\$11.20	\$10.42	46
			RG58, RG303, RG141, PE-C195, PE-P195, LMR-195, .195 inch	<a href="#">PE4523</a>	\$17.47	\$16.25	\$15.02	\$13.98	47
			RG55, RG142, RG223, RG400	<a href="#">PE4593</a>	\$15.96	\$14.84	\$13.73	\$12.77	48
		Clamp/Solder	RG174, RG316, RG188, .100 inch, PE-B100, PE-C100, LMR-100	<a href="#">PE4200</a>	\$15.49	\$14.41	\$13.32	\$12.39	49
			RG178, RG196	<a href="#">PE4250</a>	\$20.05	\$18.65	\$17.24	\$16.04	50
			PE-SR405AL, PE-SR405FL, RG405	<a href="#">PE4356</a>	\$13.11	\$12.19	\$11.27	\$10.49	51
	Solder/Solder	RG405, PE-SR405FL, PE-SR405FLJ	<a href="#">PE45119</a>	\$8.32	\$7.74	\$7.16	\$6.66	52	
PCB Mount		Solder	Thru Hole with .200 inch x .067 inch Hole Spacing	<a href="#">PE4366</a>	\$22.53	\$20.95	\$19.38	\$18.02	53
Terminal		Solder	Solder Cup with .177 inch D Hole	<a href="#">PE4288</a>	\$28.11	\$26.14	\$24.17	\$22.49	54
Cable Connectors	<b>Plug Right Angle</b>								
		Crimp/Solder	RG174, RG316, RG188, LMR-100, PE-B100, PE-C100, .100 inch	<a href="#">PE4052</a>	\$9.33	\$8.68	\$8.02	\$7.46	55
			RG178, RG196	<a href="#">PE4159</a>	\$18.31	\$17.03	\$15.75	\$14.65	56
			RG58, RG303, RG141, PE-C195, PE-P195, LMR-195, .195 inch	<a href="#">PE4522</a>	\$20.73	\$19.28	\$17.83	\$16.58	57
			RG55, RG142, RG223, RG400	<a href="#">PE4595</a>	\$18.93	\$17.60	\$16.28	\$15.14	58
	Clamp/Solder	PE-SR405AL, PE-SR405FL, PE-SR405FLJ, PE-SR405TN, RG405	<a href="#">PE4358</a>	\$17.17	\$15.97	\$14.77	\$13.74	59	
Cable Connectors	<b>Jack</b>								
		Crimp/Solder	RG174, RG316, RG188, LMR-100, PE-B100, PE-C100, .100 inch	<a href="#">PE4096</a>	\$13.73	\$12.77	\$11.81	\$10.98	60
			RG178, RG196	<a href="#">PE4926</a>	\$24.56	\$22.84	\$21.12	\$19.65	61
		Clamp/Solder	RG178, RG196	<a href="#">PE4269</a>	\$25.68	\$23.88	\$22.08	\$20.54	62
PE-SR405AL, PE-SR405FL, RG405			<a href="#">PE4360</a>	\$16.26	\$15.12	\$13.98	\$13.01	63	
PCB Mount		Solder	Thru Hole with .200 inch x .067 inch Hole Spacing	<a href="#">PE4174</a>	\$6.64	\$6.18	\$5.71	\$5.31	64
			Surface Mount	<a href="#">PE44119</a>	\$8.60	\$8.00	\$7.40	\$6.88	65

\* Fits MIL-C-17 and equivalent cable versions only



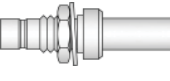
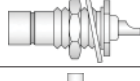

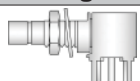

Connectors

See Our Website For Current Pricing & Real-Time Stock Availability!

# SMB Connectors

Connection Method	Product Image	Attachment Cable/Contact	Coax Type / Termination Type	Model No.	Price				ROW
					1-24	25-49	50-99	100 +	
<b>Jack, Bulkhead Mount</b>									
Cable Connectors		Crimp/Solder	RG174, RG316, RG188, LMR-100, PE-B100, PE-C100, .100 inch	<a href="#">PE4097</a>	\$15.63	\$14.54	\$13.44	\$12.50	66
			RG178, RG196	<a href="#">PE4364</a>	\$14.83	\$13.79	\$12.75	\$11.86	67
			RG55, RG141, RG142, RG223, RG400 with .177 inch D Hole	<a href="#">PE44048</a>	\$30.81	\$28.65	\$26.50	\$24.65	68
			RG58	<a href="#">PE44094</a>	\$25.77	\$23.97	\$22.16	\$20.62	69
Terminal		Solder	Solder Cup with .177 inch D Hole	<a href="#">PE4167</a>	\$6.83	\$6.35	\$5.87	\$5.46	70
			Solder Cup with .177 inch D Hole	<a href="#">PE4170</a>	\$13.76	\$12.80	\$11.83	\$11.01	71
PCB Mount			Thru Hole with .177 inch D Hole	<a href="#">PE44123</a>	\$18.46	\$17.17	\$15.88	\$14.77	72
<b>Jack, 4 Hole Flange Mount</b>									
Terminal		Solder	Solder Cup with .232 inch Hole Spacing	<a href="#">PE44142</a>	\$24.38	\$22.67	\$20.97	\$19.50	73
<b>Jack Right Angle</b>									
PCB Mount		Solder	Thru Hole with .200 inch x .067 inch Hole Spacing	<a href="#">PE4177</a>	\$11.10	\$10.32	\$9.55	\$8.88	74
			Surface Mount	<a href="#">PE44121</a>	\$20.44	\$19.01	\$17.58	\$16.35	75
<b>Jack Right Angle, Bulkhead Mount</b>									
PCB Mount		Solder	Thru Hole with .177 inch D Hole	<a href="#">PE44875</a>	\$18.98	\$17.65	\$16.32	\$15.18	76

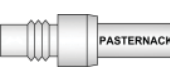
# SMC Connectors

Connection Method	Product Image	Attachment Cable/Contact	Coax Type / Termination Type	Model No.	Price				ROW
					1-24	25-49	50-99	100 +	
<b>Plug</b>									
Cable Connectors		Crimp/Solder	RG174, RG316, RG188, LMR-100, PE-B100, PE-C100, .100 inch	<a href="#">PE4045</a>	\$12.07	\$11.23	\$10.38	\$9.66	77
			RG178, RG196	<a href="#">PE4074</a>	\$16.93	\$15.74	\$14.56	\$13.54	78
			RG188-DS, RG316-DS	<a href="#">PE45155</a>	\$11.08	\$10.30	\$9.53	\$8.86	79
			PE-P195, PE-C195, RG58, RG141, RG303, .195 inch, LMR-195	<a href="#">PE4558</a>	\$21.63	\$20.12	\$18.60	\$17.30	80
		Clamp/Solder	RG174, RG316, RG188, LMR-100, PE-B100, PE-C100, .100 inch	<a href="#">PE4201</a>	\$13.00	\$12.09	\$11.18	\$10.40	81
<b>Plug Right Angle</b>									
Cable Connectors		Crimp/Solder	RG174, RG316, RG188, LMR-100, PE-B100, PE-C100, .100 inch	<a href="#">PE4051</a>	\$16.93	\$15.74	\$14.56	\$13.54	82
			RG178, RG196	<a href="#">PE4160</a>	\$16.01	\$14.89	\$13.77	\$12.81	83
PCB Mount		Solder	Thru Hole with .200 inch x .067 inch Hole Spacing	<a href="#">PE4246</a>	\$40.79	\$37.93	\$35.08	\$32.63	84
<b>Jack</b>									
Cable Connectors		Crimp/Solder	RG174, RG316, RG188, LMR-100, PE-B100, PE-C100, .100 inch	<a href="#">PE4094</a>	\$16.57	\$15.41	\$14.25	\$13.26	85
			RG188-DS, RG316-DS	<a href="#">PE45156</a>	\$14.81	\$13.77	\$12.74	\$11.85	86
PCB Mount		Solder	Thru Hole with .200 inch x .067 inch Hole Spacing	<a href="#">PE4175</a>	\$8.65	\$8.04	\$7.44	\$6.92	87
			Surface Mount	<a href="#">PE44120</a>	\$16.22	\$15.08	\$13.95	\$12.98	88
			.062 inch End Launch	<a href="#">PE44130</a>	\$48.91	\$45.49	\$42.06	\$39.13	89
<b>Jack, Bulkhead Mount</b>									
Cable Connectors		Crimp/Solder	RG174, RG316, RG188, LMR-100, PE-B100, PE-C100, .100 inch with .177 inch D Hole	<a href="#">PE4095</a>	\$15.63	\$14.54	\$13.44	\$12.50	90
			RG58	<a href="#">PE44095</a>	\$24.87	\$23.13	\$21.39	\$19.90	91

\* Fits MIL-C-17 and equivalent cable versions only



Free Shipping Available via UPS Ground to USA & Canada



Technical Support (866) 727-8376







Same-Day Shipping, Even Custom Cable Assemblies



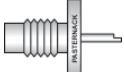

Connectors

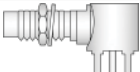
See Our Website For Current Pricing & Real-Time Stock Availability!

# SMC Connectors

Connection Method	Product Image	Attachment Cable/Contact	Coax Type / Termination Type	Model No.	Price				ROW
					1-24	25-49	50-99	100 +	
PCB Mount		Solder	Thru Hole with .177 inch D Hole	<a href="#">PE44124</a>	\$29.20	\$27.16	\$25.11	\$23.36	92
Terminal			Solder Cup with .177 inch D Hole	<a href="#">PE4107</a>	\$12.73	\$11.84	\$10.95	\$10.18	93
			Solder Cup with .177 inch D Hole	<a href="#">PE4171</a>	\$12.07	\$11.23	\$10.38	\$9.66	94
<b>Jack, 4 Hole Flange Mount</b>									
Terminal		Solder	Solder Cup with .232 inch Hole Spacing	<a href="#">PE44143</a>	\$20.05	\$18.65	\$17.24	\$16.04	95
<b>Jack Right Angle</b>									
PCB Mount		Solder	Thru Hole with .200 inch x .067 inch Hole Spacing	<a href="#">PE4178</a>	\$14.58	\$13.56	\$12.54	\$11.66	96
<b>Jack Right Angle, Bulkhead Mount</b>									
PCB Mount		Solder	Thru Hole with .177 inch D Hole	<a href="#">PE44127</a>	\$22.44	\$20.87	\$19.30	\$17.95	97

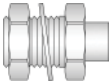
# SMP Connectors





Connection Method	Product Image	Attachment Cable/Contact	Coax Type / Termination Type	Model No.	Price				ROW
					1-24	25-49	50-99	100 +	
<b>Male</b>									
PCB Mount		Solder	Thru Hole with .100 inch x .031 inch Hole Spacing	<a href="#">PE44348</a>	\$30.24	\$28.12	\$26.01	\$24.19	98
			Thru Hole	<a href="#">PE44480</a>	\$31.72	\$29.50	\$27.28	\$25.38	99
			Surface Mount	<a href="#">PE44481</a>	\$33.30	\$30.97	\$28.64	\$26.64	1
			End Launch	<a href="#">PE44482</a>	\$24.34	\$22.64	\$20.93	\$19.47	2
			Thru Hole	<a href="#">PE44840</a>	\$9.81	\$9.12	\$8.44	\$7.85	3
			End Launch	<a href="#">PE44879</a>	\$12.59	\$11.71	\$10.83	\$10.07	4
			Thru Hole	<a href="#">PE44910</a>	\$32.45	\$30.18	\$27.91	\$25.96	5
			Thru Hole	<a href="#">PE44936</a>	\$36.71	\$34.14	\$31.57	\$29.37	6
			Surface Mount	<a href="#">PE44944</a>	\$51.32	\$47.73	\$44.14	\$41.06	7
			Surface Mount	<a href="#">PE44946</a>	\$28.46	\$26.47	\$24.48	\$22.77	8
			Surface Mount	<a href="#">PE44947</a>	\$79.43	\$73.87	\$68.31	\$63.54	9
			Edge Launch	<a href="#">PE44955</a>	\$31.08	\$28.90	\$26.73	\$24.86	10
			Thru Hole	<a href="#">PE44957</a>	\$41.95	\$39.01	\$36.08	\$33.56	11
			Thru Hole	<a href="#">PE44965</a>	\$29.70	\$27.62	\$25.54	\$23.76	12
Terminal		Solder	Surface Mount	<a href="#">PE45278 TR1</a>	\$34.67	\$32.24	\$29.82	\$27.74	13
			Surface Mount	<a href="#">PE45278 TR1500</a>	Call	Call	Call	Call	14
Terminal		Solder	Pin	<a href="#">PE44779</a>	\$19.74	\$18.36	\$16.98	\$15.79	15
			Pin	<a href="#">PE44780</a>	\$20.11	\$18.70	\$17.29	\$16.09	16
<b>Male, Bulkhead Mount</b>									
Cable Connectors		Solder/Solder	RG405, RG405 Tinned, PE-SR405FL, PE-SR405AL, PE-SR405FLJ, PE-SR405TN with 4.83 mm Diameter	<a href="#">PE44483</a>	\$39.15	\$36.41	\$33.67	\$31.32	17
			PE-SR405AL, PE-SR405FL, PE-SR405FLJ, PE-SR405TN, RG405	<a href="#">PE44961</a>	\$35.40	\$32.92	\$30.44	\$28.32	18
			RG405, PE-SR405FL, PE-SR405FLJ	<a href="#">PE45126</a>	\$31.83	\$29.60	\$27.37	\$25.46	19
<b>Male, 2 Hole Flange Mount</b>									
Cable Connectors		Solder/Solder	RG405, PE-SR405FL, PE-SR405FLJ	<a href="#">PE45127</a>	\$33.82	\$31.45	\$29.09	\$27.06	20
<b>Male, Thread-In</b>									
Shroud		None	None	<a href="#">PE44906</a>	\$22.90	\$21.30	\$19.69	\$18.32	21

\* Fits MIL-C-17 and equivalent cable versions only

Connectors

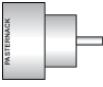
See Our Website For Current Pricing & Real-Time Stock Availability!

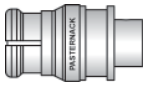

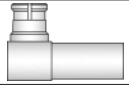
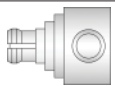
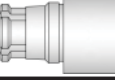
# SMP Connectors

Connection Method	Product Image	Attachment Cable/Contact	Coax Type / Termination Type	Model No.	Price				ROW
					1-24	25-49	50-99	100 +	
Terminal		Solder	Pin	<a href="#">PE44909</a>	\$39.88	\$37.09	\$34.30	\$31.90	22
			Pin	<a href="#">PE44931</a>	\$49.75	\$46.27	\$42.78	\$39.80	23
			Pin	<a href="#">PE44956</a>	\$69.41	\$64.55	\$59.69	\$55.53	24
			Pin	<a href="#">PE44963</a>	\$38.22	\$35.54	\$32.87	\$30.58	25
Terminal		Solder	Male, Solder						
			Pin	<a href="#">PE44918</a>	\$32.58	\$30.30	\$28.02	\$26.06	26
			Pin	<a href="#">PE44921</a>	\$28.85	\$26.83	\$24.81	\$23.08	27
			Pin	<a href="#">PE44922</a>	\$33.48	\$31.14	\$28.79	\$26.78	28
			Pin	<a href="#">PE44924</a>	\$31.95	\$29.71	\$27.48	\$25.56	29
PCB Mount		Solder	Thru Hole	<a href="#">PE44934</a>	\$56.49	\$52.54	\$48.58	\$45.19	31
Cable Connectors		Solder/Solder	PE-047SR, PE-SR047AL, PE-SR047FL	<a href="#">PE44785</a>	\$21.80	\$20.27	\$18.75	\$17.44	32
			RG-SR405AL, PE-SR405FL, PE-SR405FLJ, PE-SR405TN, RG405	<a href="#">PE44786</a>	\$21.80	\$20.27	\$18.75	\$17.44	33
			RG405, PE-SR405AL, PE-SR405FL, PE-SR405FLJ	<a href="#">PE45285</a>	\$8.42	\$7.83	\$7.24	\$6.74	34
			RG178, RG196	<a href="#">PE45287</a>	\$8.36	\$7.77	\$7.19	\$6.69	35
	PCB Mount		Solder	Thru Hole	<a href="#">PE45277</a>	\$4.26	\$3.96	\$3.66	\$3.41
Cable Connectors		Crimp/Crimp	RG178, RG196	<a href="#">PE45290</a>	\$9.22	\$8.57	\$7.93	\$7.38	38
			RG316, RG174, LMR-100	<a href="#">PE45128</a>	\$14.23	\$13.23	\$12.24	\$11.38	39
			PE-SR405AL, PE-SR405FL, PE-SR405FLJ, PE-SR405TN, RG405	<a href="#">PE44275</a>	\$30.34	\$28.22	\$26.09	\$24.27	40
			PE-047SR, PE-SR047FL, PE-SR047AL	<a href="#">PE44911</a>	\$32.40	\$30.13	\$27.86	\$25.92	41
	Cable Connectors		Solder/Solder	RG405, PE-SR405FL, PE-SR405FLJ	<a href="#">PE44913</a>	\$55.04	\$51.19	\$47.33	\$44.03
RG405, PE-SR405FL, PE-SR405FLJ				<a href="#">PE44915</a>	\$27.20	\$25.30	\$23.39	\$21.76	43
RG405, PE-SR405AL, PE-SR405FL, PE-SR405FLJ				<a href="#">PE45248</a>	\$8.86	\$8.24	\$7.62	\$7.09	44
Cable Connectors		Solder	PE-047SR, PE-SR047AL, PE-SR047FL	<a href="#">PE45249</a>	\$9.22	\$8.57	\$7.93	\$7.38	45

Connectors

See Our Website For Current Pricing & Real-Time Stock Availability!

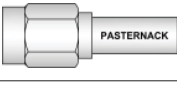
# SSMA Connectors

Connection Method	Product Image	Attachment Cable/Contact	Coax Type / Termination Type	Model No.	Price				ROW
					1-24	25-49	50-99	100 +	
Cable Connectors		Crimp/Solder	Male						
			RG174, RG316, RG188, LMR-100, PE-B100, PE-C100, .100 inch	<a href="#">PE44379</a>	\$23.42	\$21.78	\$20.14	\$18.74	46
			RG178, RG196	<a href="#">PE44381</a>	\$27.45	\$25.53	\$23.61	\$21.96	47
			RG188-DS, RG316-DS	<a href="#">PE44416</a>	\$21.77	\$20.25	\$18.72	\$17.42	48
			RG174, RG316, RG188	<a href="#">PE4184</a>	\$23.41	\$21.77	\$20.13	\$18.73	49
Cable Connectors		Solder/Solder	PE-SR405AL, PE-SR405FL, PE-SR405FLJ, RG405	<a href="#">PE44383</a>	\$31.98	\$29.74	\$27.50	\$25.58	50
			Male Right Angle						
Cable Connectors		Crimp/Solder	RG174, RG316, RG188, PE-B100, PE-C100, .100 inch, LMR-100	<a href="#">PE44378</a>	\$27.62	\$25.69	\$23.75	\$22.10	51
			RG178, RG196	<a href="#">PE44380</a>	\$54.68	\$50.85	\$47.02	\$43.74	52

\* Fits MIL-C-17 and equivalent cable versions only



Free Shipping Available via UPS Ground to USA & Canada



Technical Support (866) 727-8376









Same-Day Shipping, Even Custom Cable Assemblies

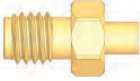

# SSMA Connectors

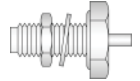
Connection Method	Product Image	Attachment Cable/Contact	Coax Type / Termination Type	Model No.	Price				ROW
					1-24	25-49	50-99	100 +	
Cable Connectors	<b>Male Right Angle</b>								
		Solder/Solder	PE-SR405AL, PE-SR405FL, PE-SR405FLJ, RG405	<a href="#">PE44384</a>	\$37.85	\$35.20	\$32.55	\$30.28	53

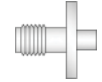
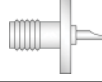
# SSMA Connectors







Connection Method	Product Image	Attachment Cable/Contact	Coax Type / Termination Type	Model No.	Price				ROW
					1-24	25-49	50-99	100 +	
Cable Connectors	<b>Female</b>								
		Crimp/Solder	RG174, RG316, RG188, PE-B100, PE-C100, .100 inch, LMR-100	<a href="#">PE44385</a>	\$28.41	\$26.42	\$24.43	\$22.73	54
		Solder/Solder	PE-SR405AL, PE-SR405FL, PE-SR405FLJ, RG405	<a href="#">PE44387</a>	\$27.21	\$25.31	\$23.40	\$21.77	55
PCB Mount		Solder	Thru Hole with .200 inch x .067 inch Hole Spacing	<a href="#">PE44391</a>	\$30.87	\$28.71	\$26.55	\$24.70	56
Cable Connectors	<b>Female, Bulkhead Mount</b>								
		Crimp/Solder	.100 inch, RG316, RG174, RG188, LMR-100, LMR-100A, LMR-100A-FR, PE-C100, PE-B100 with .177 inch D Hole	<a href="#">PE44388</a>	\$38.95	\$36.22	\$33.50	\$31.16	57
			RG178, RG196 with .177 inch D Hole	<a href="#">PE44389</a>	\$33.23	\$30.90	\$28.58	\$26.58	58
			RG188-DS, RG316-DS with .177 inch D Hole	<a href="#">PE44426</a>	\$27.06	\$25.17	\$23.27	\$21.65	59
		Solder/Solder	PE-047SR, PE-SR047AL, PE-SR047FL with .177 inch D Hole	<a href="#">PE44429</a>	\$43.85	\$40.78	\$37.71	\$35.08	60
Terminal		Solder	Turret with .177 inch D Hole	<a href="#">PE44392</a>	\$33.67	\$31.31	\$28.96	\$26.94	61
			Solder Cup with .177 inch D Hole	<a href="#">PE44393</a>	\$30.31	\$28.19	\$26.07	\$24.25	62
PCB Mount		Solder	.042 inch End Launch	<a href="#">PE45405</a>	\$26.21	\$24.38	\$22.54	\$20.97	63
			.062 inch End Launch	<a href="#">PE45406</a>	\$26.21	\$24.38	\$22.54	\$20.97	64
Cable Connectors	<b>Female, 2 Hole Flange Mount</b>								
		Solder/Solder	PE-047SR, PE-SR047AL, PE-SR047FL with .328 inch Hole Spacing	<a href="#">PE44436</a>	\$39.75	\$36.97	\$34.19	\$31.80	65
Terminal		Solder	Pin with .328 inch Hole Spacing	<a href="#">PE44433</a>	\$44.23	\$41.13	\$38.04	\$35.38	66
Terminal	<b>Female, 4 Hole Flange Mount</b>								
		Solder	Pin with .232 inch Hole Spacing	<a href="#">PE44434</a>	\$39.44	\$36.68	\$33.92	\$31.55	67
PCB Mount		Solder	Thru Hole with .200 inch x .067 inch Hole Spacing	<a href="#">PE44435</a>	\$44.53	\$41.41	\$38.30	\$35.62	68

\* Fits MIL-C-17 and equivalent cable versions only

Connectors







See Our Website For Current Pricing & Real-Time Stock Availability!

# SSMB Connectors

Connection Method	Product Image	Attachment Cable/Contact	Coax Type / Termination Type	Model No.	Price				ROW
					1-24	25-49	50-99	100 +	
<b>Plug</b>									
Cable Connectors		Crimp/Solder	RG174, RG316, RG188, LMR-100, PE-B100, PE-C100, .100 inch	<a href="#">PE4017</a>	\$28.69	\$26.68	\$24.67	\$22.95	69
			RG174, RG179, RG316, RG188, PE-B100, PE-C100, .100 inch, LMR-100	<a href="#">PE4334</a>	\$49.60	\$46.13	\$42.66	\$39.68	70
Cable Connectors		Crimp/Solder	RG178, RG196	<a href="#">PE45195</a>	\$16.12	\$14.99	\$13.86	\$12.90	71
<b>Jack</b>									
PCB Mount		Solder	Thru Hole with .100 inch x .031 inch Hole Spacing	<a href="#">PE4340</a>	\$12.72	\$11.83	\$10.94	\$10.18	72
<b>Jack, Bulkhead Mount</b>									
Cable Connectors		Crimp/Solder	.100 inch, RG316, RG174, RG188, LMR-100, LMR-100A, LMR-100A-FR, PE-C100, PE-B100 with .126 inch D Hole	<a href="#">PE4336</a>	\$33.80	\$31.43	\$29.07	\$27.04	73
			RG178, RG196 with .126 inch D Hole	<a href="#">PE4337</a>	\$30.17	\$28.06	\$25.95	\$24.14	74
<b>Jack, 4 Hole Flange Mount</b>									
Terminal		Solder	Tab with .164 inch x .067 inch Hole Spacing	<a href="#">PE44455</a>	\$22.74	\$21.15	\$19.56	\$18.19	75
<b>Jack Right Angle</b>									
PCB Mount		Solder	Thru Hole with .100 inch x .031 inch Hole Spacing	<a href="#">PE4341</a>	\$20.79	\$19.33	\$17.88	\$16.63	76

Connectors

# SSMC Connectors

Connection Method	Product Image	Attachment Cable/Contact	Coax Type / Termination Type	Model No.	Price				ROW
					1-24	25-49	50-99	100 +	
<b>Plug</b>									
Cable Connectors		Crimp/Solder	RG316, RG174, RG188	<a href="#">PE45209</a>	\$14.69	\$13.66	\$12.63	\$11.75	77
			RG178, RG196	<a href="#">PE45367</a>	\$26.37	\$24.52	\$22.68	\$21.10	78
			LMR-100A, RG188, RG174, PE-C100-LSZH, PE-B100, LMR-100A-FR, RG316	<a href="#">PE45368</a>	\$24.15	\$22.46	\$20.77	\$19.32	79
			RG188-DS, RG316-DS	<a href="#">PE45369</a>	\$25.77	\$23.97	\$22.16	\$20.62	80
			PE-SR405AL, PE-SR405FL, PE-SR405FLJ, PE-SR405TN, RG405	<a href="#">PE45365</a>	\$23.48	\$21.84	\$20.19	\$18.78	81
		Clamp/Solder	PE-047SR, PE-SR047AL, PE-SR047FL	<a href="#">PE45366</a>	\$23.73	\$22.07	\$20.41	\$18.98	82
<b>Plug Right Angle</b>									
Cable Connectors		Crimp/Solder	RG178, RG196	<a href="#">PE45381</a>	\$18.27	\$16.99	\$15.71	\$14.62	83
			RG316, RG188, RG174, PE-C100-LSZH, PE-B100, LMR-100A-FR, LMR-100A	<a href="#">PE45382</a>	\$20.84	\$19.38	\$17.92	\$16.67	84
			RG316-DS, RG188-DS	<a href="#">PE45383</a>	\$20.53	\$19.09	\$17.66	\$16.42	85
			PE-SR405AL, PE-SR405FL, PE-SR405FLJ, PE-SR405TN, RG405	<a href="#">PE45384</a>	\$20.50	\$19.07	\$17.63	\$16.40	86
		Solder/Solder	PE-047SR, PE-SR047AL, PE-SR047FL	<a href="#">PE45385</a>	\$23.59	\$21.94	\$20.29	\$18.87	87
PCB Mount		Solder	Thru Hole	<a href="#">PE45379</a>	\$28.21	\$26.24	\$24.26	\$22.57	88
<b>Jack</b>									
Cable Connectors		Crimp/Solder	RG316, RG188	<a href="#">PE45373</a>	\$22.27	\$20.71	\$19.15	\$17.82	89
			RG316-DS, RG188-DS	<a href="#">PE45374</a>	\$23.84	\$22.17	\$20.50	\$19.07	90
		Clamp/Solder	PE-047SR, PE-SR047AL, PE-SR047FL	<a href="#">PE45371</a>	\$23.45	\$21.81	\$20.17	\$18.76	91

See Our Website For Current Pricing & Real-Time Stock Availability!

\* Fits MIL-C-17 and equivalent cable versions only



Free Shipping Available via UPS Ground to USA & Canada













Technical Support (866) 727-8376



Same-Day Shipping, Even Custom Cable Assemblies

# SSMC Connectors

Connection Method	Product Image	Attachment Cable/Contact	Coax Type / Termination Type	Model No.	Price				ROW
					1-24	25-49	50-99	100 +	
PCB Mount		Solder	Surface Mount	<a href="#">PE45376</a>	\$16.36	\$15.21	\$14.07	\$13.09	92
<b>Jack, Bulkhead Mount</b>									
Cable Connectors		Crimp/Solder	RG-178, RG-196	<a href="#">PE45372</a>	\$22.54	\$20.96	\$19.38	\$18.03	93
		Clamp/Solder	PE-SR405AL, PE-SR405FL, PE-SR405FLJ, PE-SR405TN, RG405	<a href="#">PE45370</a>	\$16.92	\$15.74	\$14.55	\$13.54	94
Terminal		Solder	Turret	<a href="#">PE45375</a>	\$17.72	\$16.48	\$15.24	\$14.18	95
			Turret	<a href="#">PE45390</a>	\$16.36	\$15.21	\$14.07	\$13.09	96
<b>Jack, 2 Hole Flange Mount</b>									
Terminal		Solder	Solder Cup	<a href="#">PE45380</a>	\$109.65	\$101.97	\$94.30	\$87.72	97
<b>Jack, 4 Hole Flange Mount</b>									
Terminal		Solder	Solder Cup	<a href="#">PE45391</a>	\$60.47	\$56.24	\$52.00	\$48.38	98
<b>Jack Right Angle</b>									
Cable Connectors		Crimp/Solder	PE-SR405AL, PE-SR405FL, PE-SR405FLJ, PE-SR405TN, RG405	<a href="#">PE45387</a>	\$32.86	\$30.56	\$28.26	\$26.29	99
		Solder/Solder	PE-047SR, PE-SR047AL, PE-SR047FL	<a href="#">PE45388</a>	\$36.55	\$33.99	\$31.43	\$29.24	1
PCB Mount		Solder	Surface Mount	<a href="#">PE45377</a>	\$26.65	\$24.78	\$22.92	\$21.32	2
			Turret	<a href="#">PE45389</a>	\$33.01	\$30.70	\$28.39	\$26.41	3
<b>Jack Right Angle, Bulkhead Mount</b>									
Cable Connectors		Crimp/Solder	RG178, RG196	<a href="#">PE45386</a>	\$20.19	\$18.78	\$17.36	\$16.15	4
Terminal		Solder	Turret	<a href="#">PE45378</a>	\$38.80	\$36.08	\$33.37	\$31.04	5

# TNC Connectors

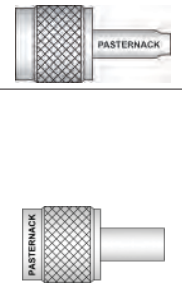
Connection Method	Product Image	Attachment Cable/Contact	Coax Type / Termination Type	Model No.	Price				ROW
					1-24	25-49	50-99	100 +	
<b>Male</b>									
Cable Connectors		Crimp/Crimp	RG55, RG142, RG223, RG400, RG141	<a href="#">PE4047</a>	\$12.75	\$11.86	\$10.97	\$10.20	6
			RG174, RG316, RG188, LMR-100, PE-B100, PE-C100, .100 inch	<a href="#">PE4302</a>	\$19.74	\$18.36	\$16.98	\$15.79	7
			PE-C200, LMR-200	<a href="#">PE44804</a>	\$8.43	\$7.84	\$7.25	\$6.74	8
			RG59*, RG62*, RG71	<a href="#">PE4071</a>	\$11.52	\$10.71	\$9.91	\$9.22	9
			RG58, RG303, RG141, PE-C195, PE-P195, LMR-195, .195 inch	<a href="#">PE4156</a>	\$7.28	\$6.77	\$6.26	\$5.82	10
			PE-C400, PE-B400, PE-B405, LMR-400, LMR-400-DB, LMR-400-UF, .400 inch	<a href="#">PE44293</a>	\$30.06	\$27.96	\$25.85	\$24.05	11
			RG213, RG8	<a href="#">PE4446</a>	\$17.42	\$16.20	\$14.98	\$13.94	12
			RG214, RG9, RG225, RG393	<a href="#">PE4447</a>	\$26.50	\$24.65	\$22.79	\$21.20	13
			PE-C240, RG8X, .240 inch, LMR-240, LMR-240-DB, LMR-240-UF, B7808A	<a href="#">PE44634</a>	\$12.33	\$11.47	\$10.60	\$9.86	14
			LMR-100, PE-C100, RG174, RG188, RG316	<a href="#">TC-100-TM</a>	\$18.78	\$18.78	\$18.78	\$18.78	15
			LMR-240, PE-C240	<a href="#">TC-240-TM-X</a>	\$8.67	\$8.67	\$8.67	\$8.67	16
			LMR-400, PE-C400	<a href="#">TC-400-TM-X</a>	\$11.30	\$11.30	\$11.30	\$11.30	17

\* Fits MIL-C-17 and equivalent cable versions only

Connectors

See Our Website For Current Pricing & Real-Time Stock Availability!

# TNC Connectors

Connection Method	Product Image	Attachment Cable/Contact	Coax Type / Termination Type	Model No.	Price				ROW
					1-24	25-49	50-99	100 +	
Cable Connectors	<b>Male</b>								
		Clamp/Solder	RG58, RG55, RG141, RG142, RG223, RG400, RG303, PE-C195, PE-P195, LMR-195	<a href="#">PE4067</a>	\$23.96	\$22.28	\$20.61	\$19.17	18
			RG213, RG214, RG8, RG9, RG11*, RG225, RG393, RG144*, RG215, RG216*	<a href="#">PE4088</a>	\$18.18	\$16.91	\$15.63	\$14.54	19
			RG59*, RG62*, RG71	<a href="#">PE4154</a>	\$14.83	\$13.79	\$12.75	\$11.86	20
			RG174, RG316, RG188	<a href="#">PE4303</a>	\$14.21	\$13.22	\$12.22	\$11.37	21
			PE-C400, PE-B400, PE-B405, LMR-400, LMR-400-DB, LMR-400-UF, .400 inch	<a href="#">PE4449</a>	\$19.58	\$18.21	\$16.84	\$15.66	22
			PE-P300LL	<a href="#">PE44810</a>	\$90.60	\$84.26	\$77.92	\$72.48	23
			PE-P142LL	<a href="#">PE44815</a>	\$52.37	\$48.70	\$45.04	\$41.90	24
			RG8X, PE-C240, .240 inch, B7808A, LMR-240	<a href="#">PE45437</a>	\$16.30	\$15.16	\$14.02	\$13.04	25
		Solder/Solder	PE-SR405AL, PE-SR405FL, PE-SR405FLJ, PE-SR405TN, RG405	<a href="#">PE44708</a>	\$13.35	\$12.42	\$11.48	\$10.68	27
			PE-SR405AL, PE-SR405FL, RG405	<a href="#">PE4649</a>	\$26.85	\$24.97	\$23.09	\$21.48	28
			LMR-200, PE-C200	<a href="#">EZ-200-TM-X</a>	\$18.76	\$18.76	\$18.76	\$18.76	29
				<a href="#">EZ-240-TM-X</a>	\$12.73	\$12.73	\$12.73	\$12.73	30
		Crimp/Non-Solder Contact	LMR-400, PE-C400, PE-B400, PE-B405	<a href="#">EZ-400-TM-X</a>	\$13.96	\$13.96	\$13.96	\$13.96	31
			LMR-600, PE-C600	<a href="#">EZ-600-TM-X</a>	\$22.47	\$22.47	\$22.47	\$22.47	32
Terminal	<b>Male, 4 Hole Flange Mount</b>								
	Solder	Solder Cup with .531 inch Hole Spacing	<a href="#">PE4470</a>	\$19.61	\$18.24	\$16.86	\$15.69	33	
Cable Connectors	<b>Male Right Angle</b>								
		Crimp/Crimp	RG58, RG303, RG141, PE-C195, PE-P195, LMR-195, .195 inch	<a href="#">PE4451</a>	\$23.84	\$22.17	\$20.50	\$19.07	34
				Crimp/Solder	RG55, RG141, RG142, RG223, RG400	<a href="#">PE4450</a>	\$17.07	\$15.88	\$14.68
	RG59*, RG62*, RG71	<a href="#">PE4453</a>			\$23.90	\$22.23	\$20.55	\$19.12	36
	RG174, RG316, RG188, .100 inch, PE-B100, PE-C100, LMR-100	<a href="#">PE4455</a>			\$24.73	\$23.00	\$21.27	\$19.78	37
	PE-C240, RG8X, .240 inch, LMR-240, LMR-240-DB, LMR-240-UF, B7808A	<a href="#">PE44635</a>			\$24.99	\$23.24	\$21.49	\$19.99	38
		Clamp/Solder	PE-C200, LMR-200	<a href="#">PE44846</a>	\$19.14	\$17.80	\$16.46	\$15.31	39
			LMR-400, PE-C400	<a href="#">TC-400-TM-RA-D</a>	\$24.98	\$24.98	\$24.98	\$24.98	40
			RG58, RG55, RG141, RG142, RG223, RG400, RG303, PE-C195, PE-P195, LMR-195	<a href="#">PE4054</a>	\$25.29	\$23.52	\$21.75	\$20.23	41
		Solder/Solder	RG213, RG214, RG8, RG9, RG11*, RG225, RG393, RG144*, RG216*, RG215	<a href="#">PE4146</a>	\$32.64	\$30.36	\$28.07	\$26.11	42
RG59*, RG62*			<a href="#">PE4452</a>	\$40.06	\$37.26	\$34.45	\$32.05	43	
PE-P160LL			<a href="#">PE45445</a>	\$133.97	\$124.59	\$115.21	\$107.18	44	
Cable Connectors	<b>Female</b>								
		Crimp/Solder	RG55, RG141, RG142, RG223, RG400	<a href="#">PE4457</a>	\$13.78	\$12.82	\$11.85	\$11.02	46
			RG58, RG303, RG141, PE-C195, PE-P195, LMR-195, .195 inch	<a href="#">PE4458</a>	\$14.66	\$13.63	\$12.61	\$11.73	47
			RG174, RG316, RG188, PE-B100, PE-C100, .100 inch, LMR-100	<a href="#">PE4462</a>	\$18.79	\$17.47	\$16.16	\$15.03	48
			PE-C240, RG8X, .240 inch, LMR-240, LMR-240-DB, LMR-240-UF, B7808A	<a href="#">PE44636</a>	\$17.27	\$16.06	\$14.85	\$13.82	49
		Clamp/Solder	RG316, RG174, LMR-100	<a href="#">PE45143</a>	\$9.55	\$8.88	\$8.21	\$7.64	50
			RG58, RG55, RG141, RG142, RG223, RG400, RG303, PE-C195, PE-P195, LMR-195	<a href="#">PE4068</a>	\$12.80	\$11.90	\$11.01	\$10.24	51
			RG213, RG214, RG8, RG9, RG11*, RG225, RG393, RG144*, RG216*, RG215	<a href="#">PE4155</a>	\$33.84	\$31.47	\$29.10	\$27.07	52

Connectors

See Our Website For Current Pricing & Real-Time Stock Availability!

\* Fits MIL-C-17 and equivalent cable versions only



Free Shipping Available via UPS Ground to USA & Canada







Technical Support (866) 727-8376



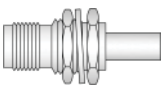
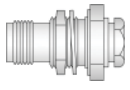
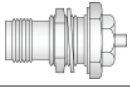

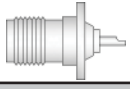
Same-Day Shipping, Even Custom Cable Assemblies

# TNC Connectors

Connection Method	Product Image	Attachment Cable/Contact	Coax Type / Termination Type	Model No.	Price				ROW
					1-24	25-49	50-99	100 +	
<b>Female, Bulkhead Mount</b>									
Cable Connectors		Crimp/Solder	RG58, RG303, RG141, PE-C195, PE-P195, LMR-195, .195 inch with .480 inch D Hole	<a href="#">PE4151</a>	\$18.88	\$17.56	\$16.24	\$15.10	53
			RG55, RG141, RG142, RG223, RG400 with .480 inch D Hole	<a href="#">PE4153</a>	\$17.90	\$16.65	\$15.39	\$14.32	54
			RG174, RG316, RG188, LMR-100, PE-B100, PE-C100, .100 inch with .480 inch D Hole	<a href="#">PE4466</a>	\$24.01	\$22.33	\$20.65	\$19.21	55
			RG174, RG316, RG188, .100 inch, PE-B100, PE-C100, LMR-100	<a href="#">PE44900</a>	\$58.48	\$54.39	\$50.29	\$46.78	56
		Clamp/Solder	PE-SR402AL, PE-SR402FL, RG402 with .480 inch D Hole	<a href="#">PE4150</a>	\$24.31	\$22.61	\$20.91	\$19.45	57
			RG58, RG142, RG223, RG400, RG141, RG303, RG55, LMR-400, PE-C195, PE-P195 with .480 inch D Hole	<a href="#">PE4152</a>	\$19.25	\$17.90	\$16.56	\$15.40	58
			RG174, RG316, RG188 with .480 inch D Hole	<a href="#">PE4304</a>	\$19.96	\$18.56	\$17.17	\$15.97	59
			RG59*, RG62*, RG71 with .480 inch D Hole	<a href="#">PE4464</a>	\$29.29	\$27.24	\$25.19	\$23.43	60
			PE-P142LL	<a href="#">PE44811</a>	\$84.46	\$78.55	\$72.64	\$67.57	61
			PE-P160LL	<a href="#">PE45444</a>	\$102.71	\$95.52	\$88.33	\$82.17	62
		Solder/Solder	PE-SR402AL, PE-SR402FL, RG402 with .480 inch D Hole	<a href="#">PE4148</a>	\$64.29	\$59.79	\$55.29	\$51.43	63
			PE-SR405AL, PE-SR405FL, PE-SR405FLJ, PE-SR405TN, RG405	<a href="#">PE44714</a>	\$16.03	\$14.91	\$13.79	\$12.82	64
Solder Cup with .350 inch D Hole			<a href="#">PE4065</a>	\$13.00	\$12.09	\$11.18	\$10.40	65	
Terminal		Solder	Eyelet with .350 inch D Hole	<a href="#">PE4305</a>	\$30.35	\$28.23	\$26.10	\$24.28	66
			Solder Cup with .350 inch D Hole	<a href="#">PE4306</a>	\$11.47	\$10.67	\$9.86	\$9.18	67
			Eyelet with .480 inch D Hole	<a href="#">PE4469</a>	\$39.81	\$37.02	\$34.24	\$31.85	68
			<b>Female, 4 Hole Flange Mount</b>						
Terminal		Solder	Solder Cup with .500 inch Threaded Hole Spacing	<a href="#">PE4064</a>	\$13.03	\$12.12	\$11.21	\$10.42	69
			Solder Cup with .500 inch Threaded Hole Spacing	<a href="#">PE4064SP</a>	\$19.41	\$18.05	\$16.69	\$15.53	70
<b>Female Right Angle, Bulkhead Mount</b>									
Terminal		Solder	Solder Cup with .361 inch D Hole	<a href="#">PE4471</a>	\$28.69	\$26.68	\$24.67	\$22.95	71

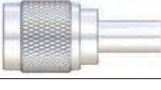
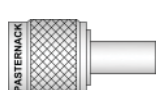
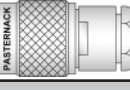
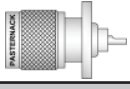
# Reverse Polarity TNC Connectors



Connection Method	Product Image	Attachment Cable/Contact	Coax Type / Termination Type	Model No.	Price				ROW	
					1-24	25-49	50-99	100 +		
<b>Male</b>										
Cable Connectors		Crimp/Crimp	LMR-200, PE-C200	<a href="#">PE45283</a>	\$17.57	\$16.34	\$15.11	\$14.06	72	
			<b>Male, 4 Hole Flange Mount</b>							
		Crimp/Solder	PE-C240, RG8X, .240 inch, LMR-240, LMR-240-DB, LMR-240-UF, B7808A	<a href="#">PE44670</a>	\$10.47	\$9.74	\$9.00	\$8.38	73	
			PE-C400, PE-B400, PE-B405, LMR-400, LMR-400-DB, LMR-400-UF, .400 inch	<a href="#">PE44672</a>	\$17.86	\$16.61	\$15.36	\$14.29	74	
			RG214, RG9, RG225, RG393	<a href="#">PE4661</a>	\$23.54	\$21.89	\$20.24	\$18.83	75	
			RG55, RG141, RG142, RG223, RG400	<a href="#">PE4663</a>	\$13.73	\$12.77	\$11.81	\$10.98	76	
			RG58	<a href="#">PE4664</a>	\$11.65	\$10.83	\$10.02	\$9.32	77	
RG174, RG316, RG188, LMR-100, PE-B100, PE-C100, .100 inch	<a href="#">PE4668</a>	\$22.32	\$20.76	\$19.20	\$17.86	78				
	Clamp/Solder	RG58, RG55, RG141, RG142, RG223, RG400, RG303, PE-C195, PE-P195, LMR-195	<a href="#">PE4662</a>	\$12.70	\$11.81	\$10.92	\$10.16	79		
		<b>Male, 4 Hole Flange Mount</b>								
Terminal		Solder	Solder Cup with .531 inch Hole Spacing	<a href="#">PE4708</a>	\$22.32	\$20.76	\$19.20	\$17.86	80	
<b>Male Right Angle</b>										
Cable Connectors		Crimp/Solder	RG55, RG141, RG142, RG223, RG400	<a href="#">PE4677</a>	\$23.17	\$21.55	\$19.93	\$18.54	81	
			RG58, RG303, RG141, PE-C195, PE-P195, LMR-195, .195 inch	<a href="#">PE4678</a>	\$25.29	\$23.52	\$21.75	\$20.23	82	
			RG316, RG174, RG188, LMR-100, PE-B100, PE-C100, .100 inch	<a href="#">PE4681</a>	\$26.81	\$24.93	\$23.06	\$21.45	83	

\* Fits MIL-C-17 and equivalent cable versions only

Connectors

See Our Website For Current Pricing & Real-Time Stock Availability!

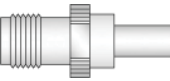
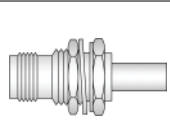
# Reverse Polarity TNC Connectors





Connection Method	Product Image	Attachment Cable/Contact	Coax Type / Termination Type	Model No.	Price				ROW
					1-24	25-49	50-99	100 +	
<b>Male Right Angle</b>									
Cable Connectors		Clamp/Solder	RG213, RG214, RG8, RG9, RG225, RG393, RG215	<a href="#">PE4675</a>	\$44.06	\$40.98	\$37.89	\$35.25	84
<b>Female</b>									
Cable Connectors		Crimp/Solder	PE-C400, PE-B400, PE-B405, LMR-400, LMR-400-DB, LMR-400-UF, .400 inch	<a href="#">PE44673</a>	\$12.53	\$11.65	\$10.78	\$10.02	85
			RG58, RG303, RG141, PE-C195, PE-P195, LMR-195, .195 inch	<a href="#">PE4686</a>	\$16.01	\$14.89	\$13.77	\$12.81	86
<b>Female, Bulkhead Mount</b>									
Cable Connectors		Crimp/Solder	RG174, RG316, RG188, .100 inch, PE-B100, PE-C100, LMR-100	<a href="#">PE44902</a>	\$48.73	\$45.32	\$41.91	\$38.98	87
			RG55, RG141, RG142, RG223, RG400 with .480 inch D Hole	<a href="#">PE4695</a>	\$18.93	\$17.60	\$16.28	\$15.14	88
			.195 inch, RG58, RG141, RG303, LMR-195, LMR-195-FR, PE-C195, PE-P195 with .480 inch D Hole	<a href="#">PE4696</a>	\$26.20	\$24.37	\$22.53	\$20.96	89
	.100 inch, RG316, RG174, RG188, LMR-100, LMR-100A, LMR-100A-FR, PE-C100, PE-B100 with .480 inch D Hole	<a href="#">PE4700</a>	\$25.77	\$23.97	\$22.16	\$20.62	90		
		Clamp/Solder	RG58, RG142, RG223, RG400, RG141, RG303, RG55, PE-C195, PE-P195 with .480 inch D Hole	<a href="#">PE4694</a>	\$21.47	\$19.97	\$18.46	\$17.18	91
			RG316, RG174, RG188 with .480 inch D Hole	<a href="#">PE4699</a>	\$22.81	\$21.21	\$19.62	\$18.25	92

## TNC Torque Wrenches



Type	Bit Hex Size (in.)	Preset Torque (in.-lbs.)	Model No.	1-24	25-49	50-99	100+	ROW
TNC	5/8 inch	14 in-lbs	<a href="#">PE5011-4</a>	\$302.48	\$281.31	\$260.13	\$241.98	
	9/16 inch	13 in-lbs	<a href="#">PE5011-8</a>	\$285.35	\$265.38	\$245.40	\$228.28	
	5/8 inch	12 in-lbs	<a href="#">PE5019-10</a>	\$213.81	\$198.84	\$183.88	\$171.05	

## UHF Connectors

Connection Method	Product Image	Attachment Cable/Contact	Coax Type / Termination Type	Model No.	Price				ROW
					1-24	25-49	50-99	100 +	
<b>Male</b>									
Cable Connectors		Crimp/Solder	RG58, RG303, RG141, PE-C195, PE-P195, LMR-195, .195 inch	<a href="#">PE4069</a>	\$9.15	\$8.51	\$7.87	\$7.32	93
			RG213, RG215, RG8	<a href="#">PE4295</a>	\$14.99	\$13.94	\$12.89	\$11.99	94
			RG55, RG141, RG142, RG223, RG400	<a href="#">PE44053</a>	\$8.26	\$7.68	\$7.10	\$6.61	95
		Clamp/Solder	RG213, RG214, RG8, RG9, RG11*, RG225, RG393, RG144*, RG215, RG216*	<a href="#">PE44050</a>	\$11.40	\$10.60	\$9.80	\$9.12	96
			RG58, RG55, RG141, RG142, RG223, RG400, RG303, PE-C195, PE-P195, LMR-195	<a href="#">PE44052</a>	\$11.33	\$10.54	\$9.74	\$9.06	97
	Solder	RG213, RG55, RG141, RG142, RG223, RG400, RG303, PE-C195, PE-P195, LMR-195	<a href="#">PE4020</a>	\$14.10	\$13.11	\$12.13	\$11.28	98	
	Crimp/Non-Solder Contact	LMR-400, PE-C400, PE-B400, PE-B405	<a href="#">EZ-400-UM</a>	\$19.66	\$19.66	\$19.66	\$19.66	99	
<b>Female</b>									
Cable Connectors		Clamp/Solder	RG213, RG214, RG8, RG9, RG11*, RG225, RG393, RG144*, RG216*, RG215	<a href="#">PE44055</a>	\$14.70	\$13.67	\$12.64	\$11.76	1

\* Fits MIL-C-17 and equivalent cable versions only



Free Shipping Available via UPS Ground to USA & Canada



Technical Support (866) 727-8376





Same-Day Shipping, Even Custom Cable Assemblies

Connectors

See Our Website For Current Pricing & Real-Time Stock Availability!



# UHF Connectors

Connection Method	Product Image	Attachment Cable/Contact	Coax Type / Termination Type	Model No.	Price				ROW
					1-24	25-49	50-99	100 +	
<b>Female, Bulkhead Mount</b>									
Terminal		Solder	Solder Cup with .575 inch D Hole	<a href="#">PE44059</a>	\$10.94	\$10.17	\$9.41	\$8.75	2
<b>Female, 4 Hole Flange Mount</b>									
Terminal		Solder	Solder Cup with .718 inch Hole Spacing	<a href="#">PE4012</a>	\$8.76	\$8.15	\$7.53	\$7.01	3

# UMCX Connectors

Connection Method	Product Image	Attachment Cable/Contact	Coax Type / Termination Type	Model No.	Price				ROW
					1-24	25-49	50-99	100 +	
<b>Jack</b>									
PCB Mount		Solder	Surface Mount	<a href="#">PE44594</a>	\$1.54	\$1.43	\$1.32	\$1.23	4

# 75 Ohm 1.0/2.3 Connectors

Connection Method	Product Image	Attachment Cable/Contact	Coax Type / Termination Type	Model No.	Price				ROW
					1-24	25-49	50-99	100 +	
<b>Plug</b>									
Cable Connectors		Crimp/Crimp	BELDEN 735A1	<a href="#">PE45227</a>	\$11.15	\$10.37	\$9.59	\$8.92	5
			BELDEN 1855A	<a href="#">PE45228</a>	\$11.15	\$10.37	\$9.59	\$8.92	6
			RG179-DS	<a href="#">PE45233</a>	\$11.15	\$10.37	\$9.59	\$8.92	7
			RG59*	<a href="#">PE45234</a>	\$11.15	\$10.37	\$9.59	\$8.92	8
			RG6-CATV	<a href="#">PE45235</a>	\$16.74	\$15.57	\$14.40	\$13.39	9
<b>Jack, Bulkhead Mount</b>									
PCB Mount		Solder	Thru Hole	<a href="#">PE45229</a>	\$14.66	\$13.63	\$12.61	\$11.73	10
			Thru Hole	<a href="#">PE45231</a>	\$17.02	\$15.83	\$14.64	\$13.62	11
			End Launch	<a href="#">PE45232</a>	\$18.97	\$17.64	\$16.31	\$15.18	12
<b>Jack Right Angle, Bulkhead Mount</b>									
PCB Mount		Solder	Thru Hole	<a href="#">PE45230</a>	\$14.66	\$13.63	\$12.61	\$11.73	13
			Thru Hole	<a href="#">PE45237</a>	\$17.33	\$16.12	\$14.90	\$13.86	14

# 75 Ohm BNC Connectors

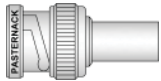
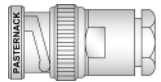



Connection Method	Product Image	Attachment Cable/Contact	Coax Type / Termination Type	Model No.	Price				ROW
					1-24	25-49	50-99	100 +	
<b>Male</b>									
Cable Connectors		Crimp/Crimp	RG59*, RG62*, RG71	<a href="#">PE4602</a>	\$10.42	\$9.69	\$8.96	\$8.34	15
			1505A	<a href="#">PE44626</a>	\$9.66	\$8.98	\$8.31	\$7.73	16
			RG6	<a href="#">PE4598</a>	\$6.55	\$6.09	\$5.63	\$5.24	17
			RG11*, RG216*, RG144*	<a href="#">PE4600</a>	\$19.61	\$18.24	\$16.86	\$15.69	18
		Clamp/Solder	RG179, RG187	<a href="#">PE4604</a>	\$12.20	\$11.35	\$10.49	\$9.76	19
			RG11*, RG144*, RG216*	<a href="#">PE4599</a>	\$31.01	\$28.84	\$26.67	\$24.81	20
			RG59*, RG62*, RG71	<a href="#">PE4601</a>	\$15.35	\$14.28	\$13.20	\$12.28	21
			RG179, RG187	<a href="#">PE4603</a>	\$14.29	\$13.29	\$12.29	\$11.43	22

\* Fits MIL-C-17 and equivalent cable versions only

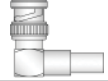
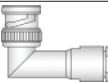

Connectors

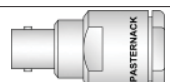
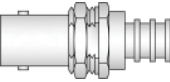
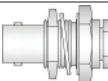
See Our Website For Current Pricing & Real-Time Stock Availability!

# 75 Ohm BNC Connectors

Connection Method	Product Image	Attachment Cable/Contact	Coax Type / Termination Type	Model No.	Price				ROW
					1-24	25-49	50-99	100 +	
<b>Male Right Angle</b>									
Cable Connectors		Crimp/Solder	RG59*, RG62*, RG71	<a href="#">PE4608</a>	\$29.14	\$27.10	\$25.06	\$23.31	23
			RG179, RG187	<a href="#">PE4610</a>	\$23.04	\$21.43	\$19.81	\$18.43	24
		Clamp/Solder	RG6	<a href="#">PE4605</a>	\$29.11	\$27.07	\$25.03	\$23.29	25
<b>Female</b>									
Cable Connectors		Crimp/Solder	735A	<a href="#">PE44688</a>	\$26.44	\$24.59	\$22.74	\$21.15	26
			RG179, RG187	<a href="#">PE4616</a>	\$17.33	\$16.12	\$14.90	\$13.86	27
		Clamp/Solder	RG6	<a href="#">PE4611</a>	\$41.22	\$38.33	\$35.45	\$32.98	28
			RG59*	<a href="#">PE4613</a>	\$18.79	\$17.47	\$16.16	\$15.03	29
			RG179, RG187	<a href="#">PE4615</a>	\$27.08	\$25.18	\$23.29	\$21.66	30
<b>Female, Bulkhead Mount</b>									
Cable Connectors		Crimp/Solder	RG59*, RG62*, RG71 with .480 inch D Hole	<a href="#">PE4638</a>	\$27.28	\$25.37	\$23.46	\$21.82	31
			RG179, RG187 with .480 inch D Hole	<a href="#">PE4640</a>	\$21.26	\$19.77	\$18.28	\$17.01	32
		Clamp/Solder	RG179, RG187 with .480 inch D Hole	<a href="#">PE4639</a>	\$27.06	\$25.17	\$23.27	\$21.65	33
Terminal		Solder	Solder Cup with .350 inch D Hole	<a href="#">PE4620</a>	\$12.94	\$12.03	\$11.13	\$10.35	34
			Turret with .480 inch D Hole	<a href="#">PE4621</a>	\$36.94	\$34.35	\$31.77	\$29.55	35
			Turret with .350 inch D Hole	<a href="#">PE4624</a>	\$32.32	\$30.06	\$27.80	\$25.86	36
			Solder Cup with .350 inch D Hole	<a href="#">PE4626</a>	\$11.23	\$10.44	\$9.66	\$8.98	37
<b>Female, 4 Hole Flange Mount</b>									
Terminal		Solder	Turret with .531 inch Hole Spacing	<a href="#">PE4618</a>	\$42.45	\$39.48	\$36.51	\$33.96	38

# 75 Ohm F Connectors

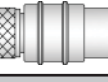
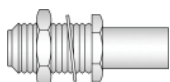
Connection Method	Product Image	Attachment Cable/Contact	Coax Type / Termination Type	Model No.	Price				ROW
					1-24	25-49	50-99	100 +	
<b>Male</b>									
Cable Connectors		Crimp/Crimp	RG59*, RG62*, RG71	<a href="#">PE44317</a>	\$4.53	\$4.21	\$3.90	\$3.62	39
			Crimp/Solder	RG6-CATV	<a href="#">PE44313</a>	\$4.71	\$4.38	\$4.05	\$3.77
	RG179, RG187	<a href="#">PE44319</a>		\$5.85	\$5.44	\$5.03	\$4.68	41	
		Crimp/Non-Solder Contact	LMR-400-75	<a href="#">PE44582</a>	\$4.69	\$4.36	\$4.03	\$3.75	42
Cable Connectors		Crimp/Solder	RG6-CATV	<a href="#">EZ-400-FM-75</a>	\$27.86	\$27.86	\$27.86	\$27.86	43
			RG59*, RG62*, RG71	<a href="#">PE44320</a>	\$6.91	\$6.43	\$5.94	\$5.53	44
			RG179, RG187 with .380 inch DD Hole	<a href="#">PE44322</a>	\$6.52	\$6.06	\$5.61	\$5.22	45
<b>Female, Bulkhead Mount</b>									
Cable Connectors		Crimp/Solder	RG6-CATV	<a href="#">PE44324</a>	\$7.88	\$7.33	\$6.78	\$6.30	46
			RG59*, RG62*, RG71	<a href="#">PE44325</a>	\$4.80	\$4.46	\$4.13	\$3.84	47
			RG179, RG187 with .380 inch DD Hole	<a href="#">PE44326</a>	\$6.25	\$5.81	\$5.38	\$5.00	48

\* Fits MIL-C-17 and equivalent cable versions only



Free Shipping Available  
via UPS Ground to  
USA & Canada



Technical Support  
(866) 727-8376





Same-Day Shipping,  
Even Custom  
Cable Assemblies

Connectors



See Our Website For Current Pricing & Real-Time Stock Availability!







# 75 Ohm MCX Connectors

Connection Method	Product Image	Attachment Cable/Contact	Coax Type / Termination Type	Model No.	Price				ROW
					1-24	25-49	50-99	100 +	
<b>Plug</b>									
Cable Connectors		Crimp/Solder	RG179, RG187	<a href="#">PE44298</a>	\$12.98	\$12.07	\$11.16	\$10.38	49
			RG179, RG187	<a href="#">PE45086</a>	\$15.57	\$14.48	\$13.39	\$12.46	50
<b>Plug Right Angle</b>									
Cable Connectors		Crimp/Solder	RG179, RG187	<a href="#">PE45086</a>	\$15.57	\$14.48	\$13.39	\$12.46	50

# 75 Ohm Mini SMB Connectors

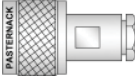
Connection Method	Product Image	Attachment Cable/Contact	Coax Type / Termination Type	Model No.	Price				ROW
					1-24	25-49	50-99	100 +	
<b>Plug</b>									
Cable Connectors		Crimp/Solder	RG179, RG187	<a href="#">PE4993</a>	\$16.47	\$15.32	\$14.16	\$13.18	51
			RG59*, RG62*, RG71	<a href="#">PE4994</a>	\$24.00	\$22.32	\$20.64	\$19.20	52
<b>Plug Right Angle</b>									
Cable Connectors		Crimp/Solder	PE-B159, 1855A, Mini 59	<a href="#">PE44589</a>	\$31.78	\$29.56	\$27.33	\$25.42	53
<b>Jack</b>									
PCB Mount		Solder	Thru Hole with .200 inch x .055 inch Hole Spacing	<a href="#">PE4997</a>	\$14.70	\$13.67	\$12.64	\$11.76	54

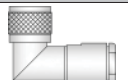
# 75 Ohm N Connectors



Connection Method	Product Image	Attachment Cable/Contact	Coax Type / Termination Type	Model No.	Price				ROW
					1-24	25-49	50-99	100 +	
<b>Male</b>									
Cable Connectors		Crimp/Solder	RG6	<a href="#">PE4508</a>	\$22.53	\$20.95	\$19.38	\$18.02	55
			RG11*, RG144*, RG216*	<a href="#">PE4510</a>	\$22.53	\$20.95	\$19.38	\$18.02	56
			RG59*, RG62*, RG71	<a href="#">PE4512</a>	\$22.32	\$20.76	\$19.20	\$17.86	57
			RG179, RG187	<a href="#">PE4656</a>	\$32.19	\$29.94	\$27.68	\$25.75	58
		Clamp/Solder	RG6	<a href="#">PE4507</a>	\$20.92	\$19.46	\$17.99	\$16.74	59
			RG11*, RG144*, RG216*	<a href="#">PE4509</a>	\$28.70	\$26.69	\$24.68	\$22.96	60
		Crimp/Non-Solder Contact	LMR-400-75	<a href="#">EZ-400-NM-75</a>	\$36.99	\$36.99	\$36.99	\$36.99	62
<b>Male, 4 Hole Flange Mount</b>									
Terminal		Solder	Solder Cup with .718 inch Hole Spacing	<a href="#">PE4504</a>	\$22.32	\$20.76	\$19.20	\$17.86	63
<b>Male Right Angle</b>									
Cable Connectors		Clamp/Solder	RG11*, RG144*, RG216*	<a href="#">PE4502</a>	\$45.28	\$42.11	\$38.94	\$36.22	64
<b>Female</b>									
Cable Connectors		Clamp/Solder	RG11*, RG144*, RG216* with .480 inch D Hole	<a href="#">PE4515</a>	\$31.26	\$29.07	\$26.88	\$25.01	65
			RG59*, RG62*, RG71 with .480 inch D Hole	<a href="#">PE4516</a>	\$35.43	\$32.95	\$30.47	\$28.34	66

\* Fits MIL-C-17 and equivalent cable versions only

Connectors

See Our Website For Current Pricing & Real-Time Stock Availability!



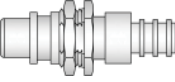

# 75 Ohm N Connectors

Connection Method	Product Image	Attachment Cable/Contact	Coax Type / Termination Type	Model No.	Price				ROW
					1-24	25-49	50-99	100 +	
<b>Female, Bulkhead Mount</b>									
Terminal		Solder	Solder Cup with .640 inch DD Hole	<a href="#">PE4505</a>	\$25.10	\$23.34	\$21.59	\$20.08	67
			Solder Cup with .380 inch Diameter	<a href="#">PE4506</a>	\$15.86	\$14.75	\$13.64	\$12.69	68
<b>Female, 4 Hole Flange Mount</b>									
Terminal		Solder	Solder Cup with .718 inch Hole Spacing	<a href="#">PE4503</a>	\$16.34	\$15.20	\$14.05	\$13.07	69

# 75 Ohm RCA Connectors

Connection Method	Product Image	Attachment Cable/Contact	Coax Type / Termination Type	Model No.	Price				ROW
					1-24	25-49	50-99	100 +	
<b>Male</b>									
Cable Connectors		Crimp/Solder	1505A	<a href="#">PE44624</a>	\$14.35	\$13.35	\$12.34	\$11.48	70
<b>Female, Bulkhead Mount</b>									
Cable Connectors		Crimp/Solder	PE-B159, 1855A, Mini 59 with .480 inch D Hole	<a href="#">PE44586</a>	\$15.84	\$14.73	\$13.62	\$12.67	71

# 75 Ohm SMB Connectors

Connection Method	Product Image	Attachment Cable/Contact	Coax Type / Termination Type	Model No.	Price				ROW
					1-24	25-49	50-99	100 +	
<b>Plug</b>									
Cable Connectors		Crimp/Solder	PE-B150, RG180, RG195	<a href="#">PE4157</a>	\$21.41	\$19.91	\$18.41	\$17.13	72
			RG179, RG187	<a href="#">PE4248</a>	\$17.94	\$16.68	\$15.43	\$14.35	73
<b>Plug, Bulkhead Mount</b>									
Terminal		Solder	Solder Cup with .295 inch D Hole	<a href="#">PE4290</a>	\$55.94	\$52.02	\$48.11	\$44.75	74
<b>Jack</b>									
PCB Mount		Solder	Thru Hole with .200 inch x .067 inch Hole Spacing	<a href="#">PE4110</a>	\$16.46	\$15.31	\$14.16	\$13.17	75
<b>Jack Right Angle</b>									
PCB Mount		Solder	Thru Hole with .200 inch x .067 inch Hole Spacing	<a href="#">PE4179</a>	\$23.01	\$21.40	\$19.79	\$18.41	76

### PasterFact™:

The terms "mast" and "tower" are often used interchangeably. However, in structural engineering terms, a tower is a self-supporting or cantilevered structure, while a mast is held up by stays.

\* Fits MIL-C-17 and equivalent cable versions only



Free Shipping Available  
via UPS Ground  
to USA & Canada











Technical  
Support  
(866) 727-8376

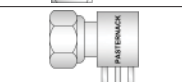
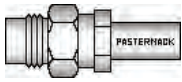

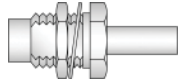

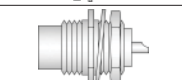
Same-Day Shipping,  
Even Custom  
Cable Assemblies

# 75 Ohm SMC Connectors

Connection Method	Product Image	Attachment Cable/Contact	Coax Type / Termination Type	Model No.	Price				ROW
					1-24	25-49	50-99	100 +	
<b>Plug</b>									
Cable Connectors		Crimp/Solder	PE-B150, RG180, RG195	<a href="#">PE4158</a>	\$24.63	\$22.91	\$21.18	\$19.70	77
			RG179, RG187	<a href="#">PE4249</a>	\$20.05	\$18.65	\$17.24	\$16.04	78
		Clamp/Solder	RG59*, RG62*, RG71	<a href="#">PE4258</a>	\$42.39	\$39.42	\$36.46	\$33.91	79
<b>Plug Right Angle</b>									
Cable Connectors		Crimp/Solder	RG180, RG195	<a href="#">PE4162</a>	\$32.59	\$30.31	\$28.03	\$26.07	80
			RG179, RG187	<a href="#">PE4252</a>	\$31.98	\$29.74	\$27.50	\$25.58	81
PCB Mount		Solder	Thru Hole with .200 inch x .067 inch Hole Spacing	<a href="#">PE4293</a>	\$38.88	\$36.16	\$33.44	\$31.10	82
<b>Jack</b>									
Cable Connectors		Crimp/Solder	RG179, RG187	<a href="#">PE4254</a>	\$30.99	\$28.82	\$26.65	\$24.79	83
				Clamp/Solder	RG179, RG187	<a href="#">PE4929</a>	\$28.69	\$26.68	\$24.67
PCB Mount		Solder	Thru Hole with .200 inch x .067 inch Hole Spacing	<a href="#">PE4176</a>	\$16.27	\$15.13	\$13.99	\$13.02	85
<b>Jack, Bulkhead Mount</b>									
Cable Connectors		Crimp/Solder	RG179, RG187 with .285 inch D Hole	<a href="#">PE4256</a>	\$30.42	\$28.29	\$26.16	\$24.34	86
				Clamp/Solder	RG179, RG187	<a href="#">PE4906</a>	\$37.45	\$34.83	\$32.21
Terminal		Solder	Solder Cup with .295 inch D Hole	<a href="#">PE4173</a>	\$25.24	\$23.47	\$21.71	\$20.19	88
<b>Jack Right Angle</b>									
PCB Mount		Solder	Thru Hole with .200 inch x .067 inch Hole Spacing	<a href="#">PE4180</a>	\$29.00	\$26.97	\$24.94	\$23.20	89

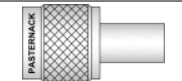
# 75 Ohm TNC Connectors



Connection Method	Product Image	Attachment Cable/Contact	Coax Type / Termination Type	Model No.	Price				ROW
					1-24	25-49	50-99	100 +	
<b>Male</b>									
Cable Connectors		Crimp/Solder	RG6	<a href="#">PE44162</a>	\$18.79	\$17.47	\$16.16	\$15.03	90
			RG11*, RG144*, RG216*	<a href="#">PE44164</a>	\$33.80	\$31.43	\$29.07	\$27.04	91
			RG179, RG187	<a href="#">PE44168</a>	\$16.56	\$15.40	\$14.24	\$13.25	92
		Clamp/Solder	RG11*, RG144*, RG216*	<a href="#">PE44163</a>	\$55.59	\$51.70	\$47.81	\$44.47	93
			RG59*	<a href="#">PE44165</a>	\$16.26	\$15.12	\$13.98	\$13.01	94
<b>Male Right Angle</b>									
Cable Connectors		Clamp/Solder	RG59*, RG62*, RG71	<a href="#">PE44171</a>	\$54.33	\$50.53	\$46.72	\$43.46	95
			RG179, RG187	<a href="#">PE44172</a>	\$50.72	\$47.17	\$43.62	\$40.58	96

\* Fits MIL-C-17 and equivalent cable versions only



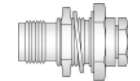

Connectors

See Our Website For Current Pricing & Real-Time Stock Availability!

# 75 Ohm TNC Connectors

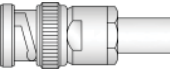
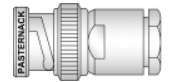
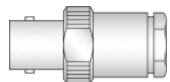
Connection Method	Product Image	Attachment Cable/Contact	Coax Type / Termination Type	Model No.	Price				ROW
					1-24	25-49	50-99	100 +	
<b>Female, Bulkhead Mount</b>									
Cable Connectors		Clamp/Solder	RG6 with .480 inch D Hole	<a href="#">PE44173</a>	\$41.90	\$38.97	\$36.03	\$33.52	97
			RG179, RG187 with .480 inch D Hole	<a href="#">PE44176</a>	\$41.92	\$38.99	\$36.05	\$33.54	98
Terminal		Solder	Solder Cup with .350 inch D Hole	<a href="#">PE44180</a>	\$21.58	\$20.07	\$18.56	\$17.26	99
			Solder Cup with .480 inch D Hole	<a href="#">PE44181</a>	\$24.38	\$22.67	\$20.97	\$19.50	1

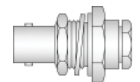
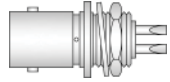
# BNC Twinax Connectors

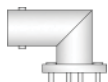
Connection Method	Product Image	Attachment Cable/Contact	Coax Type / Termination Type	Model No.	Price				ROW
					1-24	25-49	50-99	100 +	
<b>Plug</b>									
Cable Connectors		Crimp/Solder	RG108, 78 Ohm Twinax	<a href="#">PE4234</a>	\$20.09	\$18.68	\$17.28	\$16.07	2
		Clamp/Solder	RG108, 78 Ohm Twinax	<a href="#">PE4236</a>	\$25.92	\$24.11	\$22.29	\$20.74	3
<b>Jack</b>									
Cable Connectors		Clamp/Solder	RG108, 78 Ohm Twinax	<a href="#">PE4237</a>	\$32.29	\$30.03	\$27.77	\$25.83	4
PCB Mount		Solder	Thru Hole with .687 inch x .500 inch Hole Spacing	<a href="#">PE44115</a>	\$27.26	\$25.35	\$23.44	\$21.81	5
<b>Jack, Bulkhead Mount</b>									
Cable Connectors		Clamp/Solder	RG108, 78 Ohm Twinax with .480 inch D Hole	<a href="#">PE44114</a>	\$44.03	\$40.95	\$37.87	\$35.22	6
Terminal		Solder	Solder Cup with .350 inch D Hole	<a href="#">PE4238</a>	\$17.90	\$16.65	\$15.39	\$14.32	7
<b>Jack, 4 Hole Flange Mount</b>									
Terminal		Solder	Solder Cup with .500 inch Threaded Hole Spacing	<a href="#">PE4324</a>	\$26.78	\$24.91	\$23.03	\$21.42	8
<b>Jack Right Angle</b>									
PCB Mount		Solder	Thru Hole with .687 inch x .500 inch Hole Spacing	<a href="#">PE44116</a>	\$42.26	\$39.30	\$36.34	\$33.81	9

# 3/4"-20 Twinax Connectors

Connection Method	Product Image	Attachment Cable/Contact	Coax Type / Termination Type	Model No.	Price				ROW
					1-24	25-49	50-99	100 +	
<b>Male</b>									
Cable Connectors		Clamp/Solder	PE-S330	<a href="#">PE4104</a>	\$23.02	\$21.41	\$19.80	\$18.42	10

\* Fits MIL-C-17 and equivalent cable versions only



Free Shipping Available  
via UPS Ground to  
USA & Canada



Technical Support  
(866) 727-8376





Same-Day Shipping,  
Even Custom  
Cable Assemblies

Connectors

See Our Website For Current Pricing & Real-Time Stock Availability!

# 3/4"-20 Twinax Connectors

Connection Method	Product Image	Attachment Cable/Contact	Coax Type / Termination Type	Model No.	Price				ROW
					1-24	25-49	50-99	100 +	
<b>Female, Bulkhead Mount</b>									
Terminal		Solder	Solder Cup with .720 inch D Hole	<a href="#">PE4105</a>	\$23.90	\$22.23	\$20.55	\$19.12	11
<b>Female, 4 Hole Flange Mount</b>									
Terminal		Solder	Solder Cup with .718 inch Hole Spacing	<a href="#">PE4347</a>	\$28.42	\$26.43	\$24.44	\$22.74	12

\* Fits MIL-C-17 and equivalent cable versions only

## CONNECTOR DUST CAPS

### Non-Shorting Caps

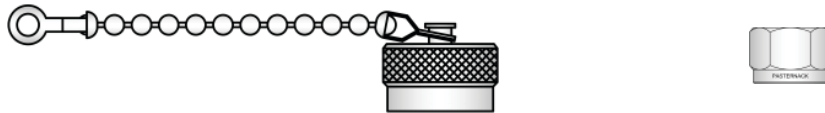

Connector	Gender	Compatible With	Chain	Model No	1-24	25-49	50-99	100+	ROW
7/16 DIN	Male	50 Ohm	Yes	<a href="#">PE6057</a>	\$41.63	\$38.72	\$35.80	\$33.30	13
	Female		Yes	<a href="#">PE6058</a>	\$47.85	\$44.50	\$41.15	\$38.28	14
BNC	Male		Yes	<a href="#">PE6013</a>	\$7.93	\$7.37	\$6.82	\$6.34	15
			No	<a href="#">PE6014</a>	\$4.43	\$4.12	\$3.81	\$3.54	16
	Female		Yes	<a href="#">PE6015</a>	\$6.47	\$6.02	\$5.56	\$5.18	17
C	Male		No	<a href="#">PE6108</a>	\$10.28	\$9.56	\$8.84	\$8.22	18
			Yes	<a href="#">PE6046</a>	\$20.06	\$18.66	\$17.25	\$16.05	19
	Female		No	<a href="#">PE6109</a>	\$23.17	\$21.55	\$19.93	\$18.54	20
			Yes	<a href="#">PE6110</a>	\$25.77	\$23.97	\$22.16	\$20.62	21
F	Male		No	<a href="#">PE6111</a>	\$21.69	\$20.17	\$18.65	\$17.35	22
			No	<a href="#">PE6240</a>	\$3.01	\$2.80	\$2.59	\$2.41	23
			Yes	<a href="#">PE6059</a>	\$26.43	\$24.58	\$22.73	\$21.14	24
HN	Female		No	<a href="#">PE6113</a>	\$19.07	\$17.74	\$16.40	\$15.26	25
			Yes	<a href="#">PE6114</a>	\$25.64	\$23.85	\$22.05	\$20.51	26
	Male		No	<a href="#">PE6115</a>	\$26.16	\$24.33	\$22.50	\$20.93	27
N	Male		Yes	<a href="#">PE6016</a>	\$6.61	\$6.15	\$5.68	\$5.29	28
			No	<a href="#">PE6017</a>	\$7.19	\$6.69	\$6.18	\$5.75	29
	Female		Yes	<a href="#">PE6018</a>	\$9.89	\$9.20	\$8.51	\$7.91	30
			No	<a href="#">PE6116</a>	\$7.98	\$7.42	\$6.86	\$6.38	31
SC	Male		Yes	<a href="#">PE6117</a>	\$37.55	\$34.92	\$32.29	\$30.04	32
	Female	Yes	<a href="#">PE6118</a>	\$29.46	\$27.40	\$25.34	\$23.57	33	
SMA	Male	Yes	<a href="#">PE6019</a>	\$10.60	\$9.86	\$9.12	\$8.48	34	
		No	<a href="#">PE6024</a>	\$3.35	\$3.12	\$2.88	\$2.68	35	
	Female	Yes	<a href="#">PE6119</a>	\$21.06	\$19.59	\$18.11	\$16.85	36	
		No	<a href="#">PE6120</a>	\$8.09	\$7.52	\$6.96	\$6.47	37	

Connectors

See Our Website For Current Pricing & Real-Time Stock Availability!

# Non-Shorting Caps

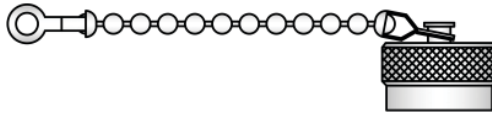

Connector	Gender	Compatible With	Chain	Model No	1-24	25-49	50-99	100+	ROW
SMB	Plug	50 Ohm	Yes	<a href="#">PE6121</a>	\$23.97	\$22.29	\$20.61	\$19.18	38
		75 Ohm	Yes	<a href="#">PE6125</a>	\$37.69	\$35.05	\$32.41	\$30.15	39
SMB	Jack	50 Ohm	Yes	<a href="#">PE6122</a>	\$20.04	\$18.64	\$17.23	\$16.03	40
			Yes	<a href="#">PE6123</a>	\$15.63	\$14.54	\$13.44	\$12.50	41
SMC	Plug	75 Ohm	Yes	<a href="#">PE6126</a>	\$32.70	\$30.41	\$28.12	\$26.16	42
			Yes	<a href="#">PE6124</a>	\$15.63	\$14.54	\$13.44	\$12.50	43
SSMA	Male	50 Ohm	No	<a href="#">PE6020</a>	\$14.73	\$13.70	\$12.67	\$11.78	44
TNC			Yes	<a href="#">PE6023</a>	\$9.23	\$8.58	\$7.94	\$7.38	45
			No	<a href="#">PE6144</a>	\$8.45	\$7.86	\$7.27	\$6.76	46
TNC			Female	Yes	<a href="#">PE6021</a>	\$11.18	\$10.40	\$9.61	\$8.94
	No	<a href="#">PE6143</a>		\$11.64	\$10.83	\$10.01	\$9.31	48	

# Shorting Caps

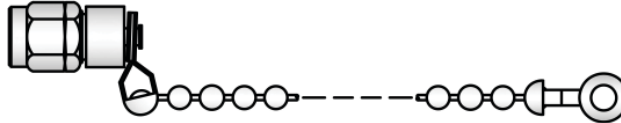
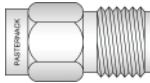

Connector	Gender	Compatible With	Chain	Model No	1-24	25-49	50-99	100+	ROW
2.4mm	Male	50 Ohm	Yes	<a href="#">PE6194</a>	\$54.01	\$50.23	\$46.45	\$43.21	49
			Yes	<a href="#">PE6195</a>	\$65.05	\$60.50	\$55.94	\$52.04	50
			No	<a href="#">PE6193</a>	\$61.73	\$57.41	\$53.09	\$49.38	51
BNC	Male	50 Ohm	Yes	<a href="#">PE6127</a>	\$19.64	\$18.27	\$16.89	\$15.71	52
			No	<a href="#">PE6012</a>	\$7.30	\$6.79	\$6.28	\$5.84	53
			Yes	<a href="#">PE6128</a>	\$22.88	\$21.28	\$19.68	\$18.30	54
BNC	Female	50 Ohm	No	<a href="#">PE6030</a>	\$13.50	\$12.56	\$11.61	\$10.80	55
			Yes	<a href="#">PE6129</a>	\$26.04	\$24.22	\$22.39	\$20.83	56
			No	<a href="#">PE6022</a>	\$19.54	\$18.17	\$16.80	\$15.63	57
N	Male	50 Ohm	Yes	<a href="#">PE6130</a>	\$41.61	\$38.70	\$35.78	\$33.29	58
			No	<a href="#">PE6031</a>	\$9.26	\$8.61	\$7.96	\$7.41	59
			Yes	<a href="#">PE6131</a>	\$26.64	\$24.78	\$22.91	\$21.31	60
SMA	Male	50 Ohm	No	<a href="#">PE6006</a>	\$20.54	\$19.10	\$17.66	\$16.43	61
			Yes	<a href="#">PE6132</a>	\$27.29	\$25.38	\$23.47	\$21.83	62
			Yes	<a href="#">PE6251</a>	\$23.48	\$21.84	\$20.19	\$18.78	63
SMA	Female	50 Ohm	No	<a href="#">PE6007</a>	\$22.32	\$20.76	\$19.20	\$17.86	64
			Yes	<a href="#">PE6134</a>	\$25.47	\$23.69	\$21.90	\$20.38	65
			No	<a href="#">PE6133</a>	\$21.46	\$19.96	\$18.46	\$17.17	66
TNC	Male	50 Ohm	Yes	<a href="#">PE6136</a>	\$24.56	\$22.84	\$21.12	\$19.65	67
			No	<a href="#">PE6135</a>	\$20.09	\$18.68	\$17.28	\$16.07	68
			Female	Yes	<a href="#">PE6135</a>	\$20.09	\$18.68	\$17.28	\$16.07

Connectors

See Our Website For Current Pricing & Real-Time Stock Availability!



Free Shipping Available  
via UPS Ground  
to USA & Canada



Technical  
Support  
(866) 727-8376



Same-Day Shipping,  
Even Custom  
Cable Assemblies

# PASTERNAK ENTERPRISES -- REACH PRODUCT COMPLIANCE PROGRAM

## **What is REACH Compliance?**

Regulation (EC) No. 1907/2006 of the European Parliament and of the Council of 18 December 2006 is commonly referred to as REACH (Registration, Evaluation, Authorization, and Restriction of Chemicals). The REACH regulation became effective on June 1, 2007 to streamline and improve the former legislative framework for chemicals available in the European Union (EU) and European Economic Area (EEA) countries.

The objective of REACH is to improve protection of human health and the protection of the environment from the exposure to chemicals. REACH compliance is mandatory for products manufactured in, or imported into the European Union (EU).

As outlined by the REACH regulation, any organization manufacturing, importing, using or placing a substance, mixture, article or product on the EU market will be responsible for ensuring that the component substances are in compliance with REACH regulations.

## **Determining REACH Compliance of Pasternack Products:**

Pasternack Enterprises does not currently either manufacture or import any chemical substances into the EU on their own or in articles (products) in quantities of 1 ton or more per year. In addition, products imported by Pasternack Enterprises' customers do not contain chemical substances intended to be released during the normal and reasonably foreseeable conditions of the product's use as defined by the REACH regulation and existing guidance.

However, under REACH, there is an obligation to ensure that articles do not contain <0.1% by weight of Substances of Very High Concern (SVHCs). SVHCs are substances that may cause cancer or other serious health or environmental effects and thus face restriction or outright bans, and are listed in a regularly-updated 'Candidate list'. The current Candidate list can be downloaded from the European Chemicals Agency (ECHA) website:

[http://echa.europa.eu/chem\\_data/authorisation\\_process/candidate\\_list\\_table\\_en.asp](http://echa.europa.eu/chem_data/authorisation_process/candidate_list_table_en.asp)

For each part that has been found to comply with the REACH SVHC reporting requirements, we show an indication of compliance adjacent to the part number using this symbol:



All products displaying this symbol on our website are assured to contain no SVHCs as defined by the Candidate List displayed on the Pasternack REACH certificate. When you locate the product you need on our website, please click on the "Product ID or Part Number". You will see the "REACH symbol" for the specific part. Click on this symbol to view the Certificate of REACH Compliance (printable if needed) for the specific product as well as the applicable ECHA SVHC Candidate list Date.

## **Pasternack Enterprises - REACH Product Compliance Program:**

At Pasternack Enterprises, we recognize our responsibility as a worldwide supplier of RF, Microwave and Fiber Optic Products subject to the REACH regulations. We have completed a comprehensive effort internally and with our supply chain to determine the REACH compliance of our products. You will find our Reach Symbol adjacent to all products on our website that have been determined by Pasternack and our supply chain to contain less than 0.1% by weight of the REACH substances. You will also see the applicable ECHA SVHC Candidate List Date. "Please refer to our website at [www.Pasternack.com](http://www.Pasternack.com).

The Pasternack Enterprises REACH Product Compliance Program is implemented in accordance with Regulation No. 1907/2006 of the European Parliament and the Council of 18 December 2006. Pasternack has implemented a REACH compliance program to address this legislation. Pasternack Enterprises does not currently either manufacture or import any chemical substances into the EU on their own or in articles (products) in quantities of 1 ton or more per year. In addition, products imported by Pasternack Enterprises' customers do not contain chemical substances intended to be released during the normal and reasonably foreseeable conditions of the product's use as defined by the REACH regulation and existing guidance. Thus, Pasternack Enterprises does not currently have a direct REACH obligation to pre-register substances. Pasternack's REACH Product Compliance is determined by a certification from our supply chain. A Pasternack product is deemed to be REACH compliant when it does not contain Substances of Very High Concern (SVHCs) beyond the specified concentration limits of less than 0.1% by weight as outlined in REACH 1907/2006/EU regulation.

## **Need More Information?**

If you have questions regarding REACH Product Certification on Pasternack's products, please contact the Pasternack REACH Compliance Team via email at [REACH@Pasternack.com](mailto:REACH@Pasternack.com) or by calling Toll-Free within North America at 1-866-PASTERNAK (1-866-727-8376). International customers, please call +1-949-261-1920.



Free Shipping Available  
via UPS Ground  
to USA & Canada



Technical  
Support  
(866) 727-8376



Same-Day Shipping,  
Even Custom  
Cable Assemblies

# PASTERNAK ENTERPRISES ROHS COMPLIANCE PROGRAM

Lead-free solder is now available for all cable assemblies upon request or online at [www.Pasternack.com](http://www.Pasternack.com).

## **Our Commitment**

At Pasternack, we recognize our responsibility as an international supplier of RF, Microwave and Millimeter wave electronics products to maintain a comprehensive RoHS compliance program. We are fully committed to offering RoHS compliance on the majority of our products and posting accurate RoHS compliance status for all of our products. We have posted this data on our website so that it can be easily found for each part number within our on-line catalogue.

## **What is RoHS Compliance?**

The European Union set forth the RoHS (Restriction of Hazardous Substances) Directive to establish environmental guidelines and legislation to reduce the presence of six (6) materials deemed hazardous to the environment. To comply, products entering the EU must not have a homogeneous presence of these materials above the following levels by weight percentage

- Lead (Pb) < 0.1%
- Mercury (Hg) < 0.1%
- Cadmium (Cd) < 0.01%
- Hexavalent Chromium (CrVI) < 0.1%
- Polybrominated Biphenyls (PBB) < 0.1%
- Polybrominated Diphenyl Esters (PBDE) < 0.1%

## **Determining Pasternack RoHS Compliance**

All products displaying this symbol on our website have been certified as RoHS Compliant. Click on the symbol to view the Certificate of RoHS Compliance for that product.



## **Lead Free Cable Assemblies**

Many of Pasternack's cable assemblies are built with leaded solder. If so, the part will not be RoHS compliant and a certificate will not be found on the product page for that assembly. However, many of these assemblies can be brought into RoHS compliance through the use of Lead-Free solder. If the assembly you desire is not RoHS compliant, there may be a RoHS compliant version with a similar part number. If so, you will see an "LF" contained in the basic part number (example PE3067LF-24 is the lead free version of PE3067-24). Please note: the "LF" designation is used only when the base part number is not RoHS compliant. Many assemblies do not include "LF" and are compliant because they are only offered in a RoHS compliant configuration.

## **For More Information**

Please direct any questions to Pasternack Enterprises Technical Support via email at [TechSupport@Pasternack.com](mailto:TechSupport@Pasternack.com) or by calling Toll-Free within North America at 1-866-PASTERNAK (866-727-8376). International customers, please use +1-949-261-1920.



# MAILING LIST CHANGES

If you receive more than one RF Product Guide with the same name and address, please notify Pasternack and pass the RF Product Guide along to a friend. Also, if you do not require multiple copies to the same company address, contact a sales representative to verify and modify your mailing information. A forms-based communications method to add, delete or modify mailing information is available at [www.pasternack.com](http://www.pasternack.com). By clicking "Contact Us", and then clicking "Remove Name from Mailing List", you may complete the form to request a change to your mailing preferences. In addition, by clicking "RF Product Guide", and then clicking "Request a Printed RF Product Guide", you may add your contact information to our mailing list. Please note service opt-in and opt-out options located on the forms. Alternatively, you may mail, email, telephone or fax Pasternack your request.

## PLACING YOUR ORDER

► **By Telephone: 866-PASTERNAK (866-727-8376)  
US & Canada, or 949-261-1920**

Our friendly sales representatives are ready to serve you from 5:00am to 5:30pm Pacific Standard Time (PST), Monday through Friday. For the most efficient service, please have ready a list of quantities and part numbers and, if paying by credit card, your MasterCard, VISA, American Express or Discover card. Note: Calls may be recorded or monitored for quality and training purposes.

► **By Fax: 949-261-7451**

Our fax lines can be accessed 7 days a week, 24 hours a day. Orders received after 4:00pm PST will be promptly processed and shipped the next business day. Please include your daytime phone number and/or email address in case we have any questions about your order.

► **By Internet: [www.Pasternack.com](http://www.Pasternack.com)  
or Email: [sales@pasternack.com](mailto:sales@pasternack.com)**

Order online 7 days a week, 24 hours a day using our online ordering system. Just search for the items you want and add them to your shopping cart. Internet orders entered after 4:00 pm PST will be promptly processed and shipped the next business day.

► **By Mail: Simply Mail Your Order To:  
Pasternack Enterprises, Inc.  
17802 Fitch  
PO Box 16759  
Irvine, CA 92623-6759 USA**

International customers, please see "International Orders" below for additional information.

### Terms and Conditions of Sale:

The following from Pasternack's Binding Terms and Conditions of Sale are provided for your convenience. A complete documentation of the Binding Terms and Conditions of Sale may be found in the back of the RF Product Guide, or on Pasternack's website at <http://www.pasternack.com/t-terms-of-sale.aspx>. Any questions or clarifications may be answered by contacting Customer Service at (+1) 949-261-1920 or by any of the methods listed above.

### No Minimum Order Requirement

### Ground Freight is Free:

On UPS Ground orders, there is no charge for shipping for USA & Canada orders of \$100.00 or greater. Otherwise, shipping or freight charges and insurance will be paid by the customer. All sales are made FOB Point (as defined by the INCOTERMS 2000) in Irvine, CA USA. Shipping or freight charges from Pasternack's Irvine, CA factory are prepaid and added to the invoice or billed collect.

### Same-Day Shipment:

Same-day shipment will apply to orders received Monday through Friday, prior to 4:00pm PST.

- All UPS air and surface options
- All FedEx air options (with an approved account number)
- Most other shipping options, including DHL (with an approved account number) and USPS

### Counter-to-Counter Shipping:

For your urgent order requiring our fastest shipping method, we will place your order on the next available flight from Santa Ana-Orange County John Wayne International Airport (Airport code: SNA) to the destination you specify. Please call for details.

### Payment Terms:

Pasternack offers a number of convenient payment methods:

**For United States customers**, we offer check, money order, MasterCard, VISA, American Express, Discover, and C.O.D. as well as open account credit to qualified institutions and businesses. Payment must be made in US Dollars.

**For Canadian customers**, we offer all of the above payment options except C.O.D.  
**For International customers**, see **International Orders**.

### Open Account Credit:

Net 30 Days terms are available to businesses, schools and agencies subject to credit approval. Approval can begin by submitting a completed Credit Application, which can be found online at:

[www.Pasternack.com/t-CreditApplication.aspx](http://www.Pasternack.com/t-CreditApplication.aspx)

### EFT/Wire Transfers:

Please contact us for details. We will inform you of the total amount which will include shipping charges and any applicable wire transfer fees. Orders will not be accepted until funds have been received in full.

WELLS FARGO BANK  
420 Montgomery St.  
San Francisco, CA 94104 USA  
Account Number: 4270 0000 0000 0000 1  
Routing Number: 121000248  
SWIFT Number: WFBUS6S

### International Orders:

In addition to the United States and its territories, Pasternack accepts international orders. All orders of international origin are exported from the US in accordance with the Export Administration Regulations. Diversion contrary to US Law is prohibited. Please see Pasternack's Binding Terms and Conditions of Sale for full details.

Pasternack has international distributors for the following countries:

**Africa:** Namibia, South Africa

**Asia-Pacific:** Australia, China PRC, India, Indonesia, Japan, Malaysia, New Zealand, Singapore, South Korea, Thailand

**Europe:** Austria, Belgium, Czech Republic, Denmark, Finland, France, Germany, Ireland, Italy, Kazakhstan, Luxembourg, Netherlands, Norway, Poland, Portugal, Russia, Slovakia, Spain, Sweden, Switzerland, Turkey, United Kingdom

**Middle East:** Israel

**South America:** Brazil

To access their complete contact information, please see our International Distributors section in this RF Product Guide. (inside back cover)

### International Shipping Charges:

Shipping or freight charges and insurance will be paid by the customer. All sales are made FOB Point (as defined by the INCOTERMS 2000) in Irvine, CA USA. We ship orders by UPS, FedEx (with an approved account number), or DHL (with approved account number) with delivery in 2 to 3 days to most locations worldwide.

### International Taxes and Duties:

Customer is responsible for duties and taxes.



Free Shipping Available  
via UPS Ground  
to USA & Canada



Technical  
Support  
(866) 727-8376



Same-Day Shipping,  
Even Custom  
Cable Assemblies

# BINDING TERMS AND CONDITIONS OF SALE

The following are the terms and conditions ("Terms and Conditions") for the sale of products ("Products") by Pasternack Enterprises, Inc. ("Pasternack") to Pasternack's customers ("Customers"). Please read this agreement carefully. Any different or additional terms set forth in customer's purchase order or similar communication are objected to and shall not be binding on the company unless a separate agreement has been signed by an authorized officer of the company. By placing an order for products from the company, or by accepting delivery of the products described on the applicable packing slip, bill of lading and/or invoice received with the products, you agree to be bound by and accept these terms and conditions of sale.

## 1. ACCEPTANCE AND CANCELLATION OF ORDERS

All orders are subject to acceptance by Pasternack in writing by a duly authorized agent of Pasternack; any written acknowledgement of receipt of an order shall not, in and of itself, constitute such acceptance. Orders accepted and processed by Pasternack may not be cancelled by Customer except as covered by the Limited Warranty. All sales are final. Cable Assemblies and Non-Standard Products are also Non-Cancelable/Non-Refundable ("NC/NR"). Non-Standard Parts are defined as Products which are special orders, custom orders, orders for non-standard products, products not customarily in stock or orders for value-added products. In the event of cancellation or other withdrawal of an order for any reason and without limiting any other remedy which Pasternack may have as a result of such cancellation or other withdrawal, reasonable cancellation or restocking charges, which shall include all expenses then incurred and commitments made by Pasternack, shall be paid by Customer to Pasternack. Customer requests to reschedule are subject to acceptance by Pasternack in its sole discretion. Orders may not be rescheduled after the order has been submitted by Pasternack to the shipment carrier.

## 2. PRICES

Orders are billed at the prices (in US dollars) in effect at the time of shipment. Prices will be as specified by Pasternack and will be applicable for the period specified in Pasternack's quote. If no period is specified, quoted prices will be applicable for thirty (30) days. The website contains the most current pricing and is the price reference for orders. Pricing included in the catalog is for reference only and final pricing is determined by the published website price. Prices shown in the RF Product Guide (Catalog) and on the website are subject to change without notice. Prices are exclusive of taxes, impositions and other charges, including: sales, use, excise, value added and similar taxes or charges imposed by any government authority, international shipping charges, forwarding agent's and broker's fees, bank fees, consular fees, document fees and import duties.

## 3. TERMS OF PAYMENT

All payments must be in US Dollars, or will be converted to US Dollars using the available exchange rate at the time of purchase.

MasterCard, VISA, Discover, and American Express credit cards, purchase cards and major bank debit cards are accepted. Payment via net thirty (30) days is available to businesses, schools and agencies or as otherwise specified by Pasternack subject to credit approval.

### For International Orders

MasterCard, VISA, and American Express credit cards are accepted. Payment via open credit account with Net thirty (30) days may be established for companies having three U.S. references accepted to Pasternack. Prepaid Wire Transfer: You can wire the funds to our bank. We will contact you with the total amount, which will include shipping charges and a \$40 wire transfer fee. Orders will not be accepted until funds have been received in full and the Purchase Order (PO) has been received. Customer is responsible for sales, use, excise, value added and similar taxes or charges imposed by any government authority, international shipping charges, forwarding agent's and broker's fees, bank fees, consular fees, document fees and import duties.

## 4. SALES TAX

California residents are required to remit sales tax. Pasternack does not remit sales tax to states other than California. Any sales tax due that is not collected by Pasternack is the responsibility of the customer.

## 5. TOLERANCES

All coaxial cable assemblies displayed in the Pasternack catalog and website have a standard cable length tolerance of  $\pm 1.5\%$  or 3/8 inches (0.375"), whichever is greater. Cable Assemblies in excess of this tolerance factor are eligible for repair and/or replacement under the terms of the Pasternack Limited Warranty.

## 6. DELIVERY AND TITLE

Shipping or freight charges and insurance will be paid by the customer. All sales are made FCA Shipping Point (as defined by the INCOTERMS 2000) in Irvine, CA USA. Shipping or freight charges from Pasternack's Irvine, CA facility are prepaid and added to the invoice, or billed collect. Subject to Pasternack's right of stoppage in transit, delivery of the Products to the carrier will constitute delivery to Customer and title and risk of loss will pass to Customer. Pasternack will make reasonable efforts to initiate shipment and schedule delivery as close as possible to Customer's requested delivery date(s). Customer acknowledges that delivery dates provided by Pasternack are estimates only and that Pasternack will not be liable for failure to deliver on such dates. Selection of the carrier and delivery route will be made by Pasternack unless specifically designated by Customer. Pasternack reserves the right to make deliveries in installments. Delay in delivery of one installment will not entitle Customer to cancel any other installment(s). Delivery of any installment of Products within thirty (30) days after the date requested will constitute a

timely delivery. Delivery of a quantity that varies from the quantity specified shall not relieve Customer of the obligation to accept delivery and pay for the Products delivered.

## 7. PASTERNAK'S LIMITED WARRANTY

All products are covered by a LIMITED WARRANTY for a period of one (1) year from the date of shipment when purchased from Pasternack Enterprises, Inc. Customer must notify Pasternack within one (1) year from date of shipment of any defective product. An approved Return Material Authorization (RMA) number must first be obtained from Pasternack prior to the return of any merchandise to Pasternack for inspection under warranty. Shipping charges for all materials returned under this Limited Warranty are to be prepaid by the Customer. This warranty is limited to the original purchaser. Pasternack's liability arising out of any sale of products to Customer is expressly limited to either (1) Credit for the purchase price paid by Customer for such products (without interest), or (2) Repair and/or replacement of such products, found to be defective after inspection by Pasternack, and such remedies shall be exclusive and in lieu of all others. THIS WARRANTY IS IN LIEU OF ANY AND ALL OTHER WARRANTIES, WHETHER ORAL, WRITTEN, EXPRESSED, IMPLIED OR STATUTORY. ANY IMPLIED WARRANTIES OF MERCHANTABILITY, FITNESS FOR A PARTICULAR PURPOSE AND NON-INFRINGEMENT ARE HEREBY DISCLAIMED. Further, no warranty will apply if the Product has been subject to misuse, neglect, accident or modification, or has been soldered or altered in any way.

All returns must be shipped to: Pasternack Enterprises, Inc.  
17802 Fitch  
Irvine, CA 92614 USA

## 8. LIMITATION OF LIABILITIES

In no event shall Pasternack be liable for any special, incidental or consequential damages of any nature including, but not limited to, damages resulting from loss of profit or revenue, recall costs, claims for service interruptions or failure to supply downtime, testing, installations or removal costs, costs of substitute products, property damage, personal injury, death or legal expenses. Customer's recovery from Pasternack for any claim shall not exceed the purchase price paid by Customer for the goods, irrespective of the nature of the claim, whether in warrant, contract or otherwise. CUSTOMER SHALL INDEMNIFY, DEFEND AND HOLD PASTERNAK HARMLESS FROM ANY CLAIMS brought by any party regarding products supplied by Pasternack and incorporated into the customer's product.

## 9. STATEMENTS AND ADVICE

If statements or advice, technical or otherwise, are offered or given to Customer, such statements or advice will be deemed to be given as an accommodation to Customer and without charge and Pasternack shall have no responsibility or liability for the content or use of such statements or advice.

## 10. EXPORT CONTROL AND EMBARGOES

Products purchased or received under these Terms and Conditions are subject to export control and economic sanctions laws, restrictions, regulations and orders of the United States. Customer agrees to comply with all applicable export control laws, restrictions and regulations of the United States and shall not export, or transfer for the purpose of re-export, any product to any embargoed country or region, including but not limited to Cuba, the Crimean Region of Ukraine, Iran, North Korea, Sudan, and Syria, or to any denied, blocked, or designated person or entity as mentioned in any such United States or foreign law or regulation. Customer represents and warrants that it is not on the Denied Persons, Specially Designated Nationals or Debarred Persons List (as identified by the U.S. Treasury Office of Foreign Asset Control (OFAC) and by the U.S. Department of Commerce, Bureau of Industry and Security (BIS), or any other United States list of prohibited persons; is not owned or controlled by any person that is on one of those lists, or is otherwise prohibited by United States or other law from purchasing the products or services hereunder. Customer shall be solely responsible to obtain any license to export, re-export or import as may be required. Customer also agrees that it will not use these products in connection with the proliferation of weapons of mass destruction, including missiles, nuclear, chemical or biological weapons.

## 11. GENERAL

The Terms and Conditions may not be modified or cancelled without Pasternack's written agreement. Accordingly, goods furnished and services rendered by Pasternack are sold only on the terms and conditions stated herein. The Terms and Conditions will be governed by and construed in accordance with the laws of the State of California and the applicable laws of the United States of America. If Customer chooses to access the Pasternack website from outside the United States, Customer does so on their own initiative and is responsible for compliance with all applicable local laws.

## 12. INTELLECTUAL PROPERTY

The drawings, text, product depictions, logos, content, product descriptions, and organization and taxonomy of Pasternack's RF Product Guide and website and of the described content within the RF Product Guide and website are proprietary to Pasternack and protected by intellectual property laws, including but not limited to United States Copyright law and United States Trademark law. Pasternack owns copyrights in these referenced works as well as the selection, arrangement, coordination and structure of the arranged content and works within their RF Product Guide and website. Use of the RF Product Guide/website does not give you any right to modify, reproduce, transmit, publish, publicly display, adapt, or create derivative works or in any way exploit any of the materials and content of Pasternack's RF Product Guide or website.

**WARNING:** Products in this catalog can expose you to chemicals including phthalates, which are known to the State of California to cause cancer and birth defects or other reproductive harm. For more information, go to [www.P65Warnings.ca.gov](http://www.P65Warnings.ca.gov). For specific products impacted, please visit [www.pasternack.com](http://www.pasternack.com).

# PART NUMBER INDEX

Note: C/R stands for the Column and/or Row location of the specific product on a given page.

Model No.	Page	C/R	Model No.	Page	C/R	Model No.	Page	C/R	Model No.	Page	C/R	Model No.	Page	C/R	Model No.	Page	C/R
CST-400	Web		PE-T2005	201	21	PE-W15TS2001	237	97	PE-W61SF005-24	229	55	PE1611	72	15	PE15A3257	44	71
DBLU	Web		PE-T2006	201	25	PE-W15TW1001	238	24	PE-W61SF005-36	229	56	PE1612	72	16	PE15A3258	44	72
EZ-200-NMH-X	134	60	PE-T2007	202	36	PE-W15TW1002	238	22	PE-W61TF005-12	230	93	PE1613	72	17	PE15A3259	44	80
EZ-200-TM-X	153	29	PE-T2008	202	44	PE-W15TW1003	238	23	PE-W61TF005-24	230	94	PE1614	72	21	PE15A3260	44	85
EZ-240-4310M-X	119	77	PE-T2009	201	17	PE-W19AT001-30	239	40	PE-W61TF005-36	230	95	PE1615	72	18	PE15A3261	44	89
EZ-240-NMH-X	134	61	PE-T2010	201	33	PE-W19A15001	228	10	PE-W62B001	223	51	PE1616	72	19	PE15A3262	43	22
EZ-240-OMH-RA-X	138	76	PE-T2011	202	60	PE-W19B001	223	41	PE-W62B002	223	52	PE1617	72	23	PE15A3263	43	20
EZ-240-SMH-RA-X	141	65	PE-T2012	201	28	PE-W19C001	223	42	PE-W62B003	223	53	PE1618	72	25	PE15A3264	43	21
EZ-240-SM-X	141	65	PE-T2013	201	18	PE-W19CA001	235	78	PE-W62B004	223	54	PE1619	72	8	PE15A3265	43	31
EZ-240-TM-X	153	30	PE-T2014	201	22	PE-W19CA002	235	79	PE-W62S001-3	233	77	PE1620	72	9	PE15A3266	44	90
EZ-400-716M-X	120	95	PE-T2015	202	48	PE-W19CP001-10	225	13	PE-W62S001-6	233	78	PE1621	72	20	PE15A3267	44	65
EZ-400-BM-X	124	5	PE-T2016	202	37	PE-W19CP001-20	225	15	PE-W62S001-9	233	79	PE1622	72	27	PE15A3268	44	86
EZ-400-FM-75	157	43	PE-T2017	202	53	PE-W19CP003-10	225	14	PE-W62S001-12	233	76	PE11S1001	196	2	PE15A3269	44	60
EZ-400-NF-BH	136	41	PE-T2018	202	45	PE-W19CP003-20	225	16	PE-W62S002-6	233	74	PE11S1002	196	1	PE15A3270	44	74
EZ-400-NM-75	158	62	PE-T2019	202	46	PE-W19S001-1	233	33	PE-W62S002-12	233	75	PE11S1003	196	4	PE15A3271	44	73
EZ-400-NMC-2-D	134	54	PE-T2020	202	40	PE-W19S001-3	233	54	PE-W62S002-12	233	73	PE11S1004	196	3	PE15A3272	44	61
EZ-400-NMH-PL-X	134	62	PE-T2021	202	51	PE-W19S001-6	233	55	PE-W62S002-12	229	57	PE11S1005	196	5	PE15A3273	44	81
EZ-400-NMH-RA-X	135	90	PE-T2022	202	42	PE-W19S001-9	233	56	PE-W62S002-12	229	58	PE11S1006	196	6	PE15A3274	44	83
EZ-400-NMH-X	134	63	PE-T2023	202	57	PE-W19S001-12	233	53	PE-W62S002-12	229	59	PE11S1007	196	7	PE15A3275	44	93
EZ-400-TM-X	153	31	PE-T2024	202	43	PE-W19TR1001	234	21	PE-W62TF005-12	230	96	PE11S1008	196	8	PE15A3276	44	67
EZ-400-UM	155	99	PE-T2025	202	41	PE-W19TS2001	237	98	PE-W62TF005-24	230	97	PE12D1001	224	92	PE15A3290	44	68
EZ-600-60M-X	120	96	PE-W19AT001-30	228	7	PE-W19TS2001	237	98	PE-W62TF005-36	230	98	PE12D1002	224	98	PE15A3291	44	69
EZ-600-NF-X	135	15	PE-W19S001	228	7	PE-W19TS2001	237	98	PE-W62TF005-36	223	55	PE12D1003	224	90	PE15A3292	44	75
EZ-600-NMC-2-D	134	55	PE-W19B001	222	35	PE-W19TW1002	238	25	PE-W75B002	223	56	PE12D1004	224	89	PE15A3293	44	76
EZ-600-NMH-RA-X	135	91	PE-W19B002	222	36	PE-W19TW1003	238	26	PE-W75S001-3	233	81	PE12D1004	224	88	PE15A3294	44	79
EZ-600-NMH-X	134	64	PE-W19CA001	235	72	PE-W22AN001	230	41	PE-W75S001-6	233	82	PE12D1005	224	87	PE15A3295	44	77
EZ-600-TM-X	153	32	PE-W19CA002	235	73	PE-W22AT001-30	239	41	PE-W75S001-9	233	83	PE13U1000	224	98	PE15A3296	44	82
EZ-SW540-716MC	Web		PE-W19CP001-10	225	1	PE-W22A15001	228	11	PE-W75S001-12	233	80	PE13U1001	224	97	PE15A3300	48	15
EZ-SW540-NM-X	134	56	PE-W19CP001-20	225	3	PE-W22B001	223	43	PE-W75S001-12	233	80	PE13U1002	224	96	PE15A3301	44	70
ET-398	142	98	PE-W19CP003-10	225	29	PE-W22B002	223	44	PE-W75S001-12	229	61	PE13U1003	224	91	PE15A3302	44	73
LMR-100A-PVC	107	19	PE-W19CP003-20	225	4	PE-W22CA001	235	80	PE-W75S001-12	229	62	PE13U1004	224	94	PE15A3303	44	84
LMR-195	107	20	PE-W19S001	228	7	PE-W22CA002	235	81	PE-W75TF005-12	230	1	PE13U1005	224	93	PE15A3304	44	87
LMR-195-FR	107	21	PE-W19S001-3	233	43	PE-W22CP001-10	225	17	PE-W75TF005-24	230	1	PE15A1000	48	84	PE15A3305	44	88
LMR-195-LFL	107	22	PE-W19S001-6	233	44	PE-W22CP001-20	225	19	PE-W75TF005-36	230	2	PE15A1001	48	96	PE15A3306	44	91
LMR-200	107	23	PE-W19S001-9	233	45	PE-W22CP003-10	225	18	PE-W90B001	223	57	PE15A1002	48	3	PE15A3307	44	92
LMR-200-FR	107	24	PE-W19S001-12	233	46	PE-W22CP003-20	225	20	PE-W90B002	223	58	PE15A1003	48	12	PE15A3308	44	96
LMR-240-JF	107	16	PE-W19TR1001	234	92	PE-W22PS1001	232	34	PE-W90B003	223	59	PE15A1003M	48	11	PE15A3309	44	99
LMR-240-JF	107	17	PE-W19TS2001	237	93	PE-W22PS1002	232	35	PE-W90B004	223	60	PE15A1004	48	14	PE15A3310	44	98
LMR-240-DB	107	26	PE-W19TS2001	237	94	PE-W22S001-6	233	59	PE-W90S001-3	233	85	PE15A1005	48	90	PE15A3311	44	97
LMR-240-JF	107	27	PE-W19TS2001	237	95	PE-W22S001-9	233	60	PE-W90S001-6	233	86	PE15A1006	48	2	PE15A3300	45	2
LMR-400	107	28	PE-W19TW1001	238	18	PE-W22S001-12	233	61	PE-W90S001-9	233	87	PE15A1007	47	44	PE15A3501	45	7
LMR-400	107	29	PE-W19TW1002	238	16	PE-W22S001-12	233	62	PE-W90S001-12	233	88	PE15A1008	47	67	PE15A3502	45	10
LMR-400-DB	107	31	PE-W19TW1003	238	17	PE-W22S005-6	229	42	PE-W90S002-3	233	89	PE15A1009	47	63	PE15A3503	44	51
LMR-400-LFL	107	30	PE-W19TW1003	238	17	PE-W22S005-12	229	43	PE-W90S002-6	233	90	PE15A1010	47	61	PE15A3504	44	52
LMR-400-LFL	107	31	PE-W19TW1003	238	17	PE-W22S005-24	229	44	PE-W90S002-6	233	90	PE15A1011	47	55	PE15A3505	44	54
LMR-500	108	32	PE-W19TW1003	238	17	PE-W22TF005-12	230	82	PE-W90S002-12	233	88	PE15A1012	47	58	PE15A3506	44	53
LMR-500-DB	108	33	PE-W19TW1003	238	17	PE-W22TF005-24	230	83	PE-W90S002-12	233	88	PE15A1013	47	60	PE15A3507	44	55
LMR-600	108	34	PE-W19TW1003	238	17	PE-W22TR1001	234	22	PE-W90S002-12	233	88	PE15A1014	47	73	PE15A3508	45	8
LMR-600-DB	108	35	PE-W19TW1003	238	17	PE-W22TR1001	234	22	PE-W90S002-12	233	88	PE15A1015	47	73	PE15A3509	45	9
LMR-SW396	108	36	PE-W19TW1003	238	17	PE-W22TS2001	237	1	PE-W90S002-12	233	88	PE15A1016	47	77	PE15A3510	45	11
LMR-SW540	108	37	PE-W19TW1003	238	17	PE-W22TS2001	237	2	PE-W90S002-12	233	88	PE15A1017	47	78	PE15A3511	45	12
PE-020SR	109	84	PE-W19TW1003	238	17	PE-W22TS2001	237	3	PE-W90S002-12	233	88	PE15A1018	47	80	PE15A3512	45	13
PE-034SR	109	85	PE-W19TW1003	238	17	PE-W22TS2001	237	4	PE-W90S002-12	233	88	PE15A1019	47	81	PE15A3513	45	14
PE-047SR	109	86	PE-W19TW1003	238	17	PE-W22TS2001	237	5	PE-W90S002-12	233	88	PE15A1020	47	82	PE15A3514	45	15
PE-047SR-STRAIGHT	109	87	PE-W19TW1003	238	17	PE-W22TS2001	237	6	PE-W90S002-12	233	88	PE15A1021	47	83	PE15A3515	45	16
PE-12ZFC	108	38	PE-W19TW1003	238	17	PE-W22TS2001	237	7	PE-W90S002-12	233	88	PE15A1022	47	84	PE15A3516	45	17
PE-12ZFH	108	39	PE-W19TW1003	238	17	PE-W22TS2001	237	8	PE-W90S002-12	233	88	PE15A1023	47	85	PE15A3517	45	18
PE-12ZFH	108	39	PE-W19TW1003	238	17	PE-W22TS2001	237	9	PE-W90S002-12	233	88	PE15A1024	47	86	PE15A3518	45	19
PE-14ZFH	108	40	PE-W19TW1003	238	17	PE-W22TS2001	237	10	PE-W90S002-12	233	88	PE15A1025	47	87	PE15A3519	45	20
PE-18SR	107	2	PE-W19TW1003	238	17	PE-W22TS2001	237	11	PE-W90S002-12	233	88	PE15A1026	47	88	PE15A3520	45	21
PE-B159-BK	107	3	PE-W19TW1003	238	17	PE-W22TS2001	237	12	PE-W90S002-12	233	88	PE15A1027	47	89	PE15A3521	45	22
PE-B159-BL	107	4	PE-W19TW1003	238	17	PE-W22TS2001	237	13	PE-W90S002-12	233	88	PE15A1028	47	90	PE15A3522	45	23
PE-B159-GR	107	5	PE-W19TW1003	238	17	PE-W22TS2001	237	14									

# PART NUMBER INDEX

Note: C/R stands for the Column and/or Row location of the specific product on a given page.

Model No.	Page	C/R	Model No.	Page	C/R	Model No.	Page	C/R	Model No.	Page	C/R	Model No.	Page	C/R	Model No.	Page	C/R
PE38645	Web		PE39564	88	53	PE3C4011-60	210	26	PE3W01379	101	21	PE4113	Web		PE4234	161	2
PE38670	Web		PE39660	88		PE3C4012	77	37	PE3W01394F	99	94	PE4114	136	25	PE4235	Web	
PE38672	Web		PE39660	Web		PE3C4012-100CM	210	27	PE3W01612	81	2	PE4115	142	20	PE4236	161	3
PE38674	Web		PE3C0031	85	96	PE3C4013	210	28	PE3W0192	94	97	PE4116	142	21	PE4237	161	4
PE38679	Web		PE3C0033	83	52	PE3C4013-100CM	210	28	PE3W02270F	87	46	PE4117	142	32	PE4238	161	7
PE38689	Web		PE3C0038	89	79	PE3C4132	82	18	PE3W02435F	97	61	PE4118	144	4	PE4239	139	12
PE38700	Web		PE3C0039	83	50	PE3C4141	82	17	PE3W02436F	94	6	PE4119	143	55	PE4240	126	72
PE38719	Web		PE3C0040	87	44	PE3C4142	78	39	PE3W03891	86	10	PE4120	143	56	PE4241	127	77
PE38746Z	80	87	PE3C0041	84	75	PE3C4145	85	1	PE3W04619	86	17	PE4121	143	89	PE4242	126	57
PE38746Z	80	83	PE3C0044	88	66	PE3C4238	86	14	PE3W04888	103	48	PE4122	Web		PE4243	126	58
PE38750A	80	84	PE3C0046	83	53	PE3C4386	78	46	PE3W05081	80	96	PE4123	Web	11	PE4244	126	66
PE38762	80	85	PE3C0048	84	58	PE3C4680-12	210	12	PE3W05930	98	76	PE4124	Web		PE4245	Web	
PE38762K	80	81	PE3C0050	84	76	PE3C4680-24	210	13	PE4000	143	91	PE4125	Web		PE4246	147	84
PE38762Z	80	82	PE3C0051	87	43	PE3C4680-48	210	14	PE4000-SF	Web		PE4126	141	69	PE4247	123	81
PE38764Z	80	86	PE3C0052	91	24	PE3C4750	86	12	PE4001	Web		PE4127	141	67	PE4248	159	73
PE38772	Web		PE3C0053	82	25	PE3C4801	100	3	PE4002	141	72	PE4128	143	78	PE4249	160	78
PE38804	Web		PE3C0054	79	63	PE3C4807	82	16	PE4003	140	16	PE4128-SF	143	79	PE4250	146	50
PE38813	Web		PE3C0055F	91	37	PE3C4969	100	1	PE4004	143	77	PE4129	133	37	PE4251	Web	
PE38830	Web		PE3C0057	81	22	PE3C4980	86	15	PE4005	140	66	PE4130	Web		PE4252	160	81
PE38857	Web		PE3C0062	83	57	PE3C5233	98	70	PE4006	133	34	PE4131	134	67	PE4254	160	83
PE38858	Web		PE3C0101	83	51	PE3C5491	102	26	PE4007	140	60	PE4132	134	50	PE4255	Web	
PE38881	Web		PE3C0102	88	67	PE3CA1001	98	73	PE4008	140	17	PE4133	133	38	PE4256	Web	
PE38889	Web		PE3C0103	91	25	PE3CA1022	98	75	PE4009	141	73	PE4134	135	92	PE4257	Web	
PE38890	Web		PE3C0104	92	59	PE3CA1025	94	7	PE4010	125	41	PE4135	135	79	PE4258	Web	79
PE38920	Web		PE3C0105	83	54	PE3CA1031-60cm	214	61	PE4011	125	42	PE4136	135	80	PE4259	Web	
PE38930	Web		PE3C0106	88	63	PE3CA1031-60cm	214	61	PE4012	125	42	PE4137	136	38	PE4260	Web	
PE38934	Web		PE3C0107	85	8	PE3CA1035	91	26	PE4013	136	51	PE4138	Web		PE4261	Web	
PE38997	Web		PE3C0109	85	97	PE3CA1039	90	17	PE4014	125	33	PE4139	136	39	PE4262	Web	
PE39035	Web		PE3C0110	83	58	PE3CA1040	92	58	PE4015	125	34	PE4140	134	51	PE4263	Web	
PE39061	Web		PE3C0112	83	59	PE3CA1102-3	214	65	PE4016	123	76	PE4141	136	46	PE4264	Web	
PE39078	101	25	PE3C0113	91	23	PE3CA1103-3	214	67	PE4017	151	69	PE4142	Web		PE4265	Web	
PE39082	Web		PE3C0119	85	9	PE3CA1104	102	28	PE4018	123	77	PE4143	Web		PE4266	Web	
PE39087	Web		PE3C0121	88	64	PE3CA1104-3	214	64	PE3CA1104-3	214	64	PE4144	Web		PE4267	Web	
PE39108	Web		PE3C0124	84	64	PE3CA1105-3	214	66	PE4020	155	98	PE4145	Web		PE4268	146	62
PE39120	Web		PE3C0142	82	29	PE3CA1106	102	29	PE4021	Web		PE4146	Web		PE4270	Web	
PE39138	Web		PE3C0218	83	55	PE3CA1106-3	214	68	PE4022	Web		PE4147	Web		PE4271	Web	
PE39143	Web		PE3C0230	89	83	PE3CA1107-3	214	63	PE4023	124	92	PE4148	154	63	PE4272	Web	
PE39148	Web		PE3C0231	82	27	PE3CT00101	213	50	PE4024	124	93	PE4149	Web		PE4273	Web	
PE39185	Web		PE3C0686	77	21	PE3TC0101-24	213	55	PE4025	141	84	PE4150	154	57	PE4274	Web	
PE39229	Web		PE3C0673	86	11	PE3TC0102	Web		PE4026	140	38	PE4151	154	53	PE4275	Web	
PE39265	Web		PE3C0689	71	53	PE3TC0102-24	213	53	PE4027	140	39	PE4152	154	68	PE4276	Web	
PE39347Z	87	45	PE3C0728	76	10	PE3TC0103	Web		PE4028	141	79	PE4153	154	54	PE4278	Web	
PE39349D	97	57	PE3C0747	76	15	PE3TC0103-24	213	51	PE4029	Web		PE4154	153	20	PE4279	Web	
PE39415	90	93	PE3C0747F	76	16	PE3TC0104	Web		PE4030	Web		PE4155	153	52	PE4280	Web	
PE39416	Web		PE3C0752	76	4	PE3TC0104-24	213	50	PE4031	142	10	PE4156	152	10	PE4281	Web	
PE39417	91	43	PE3C0757	100	98	PE3TC0105	Web		PE4032	Web		PE4157	159	72	PE4283	Web	
PE39418	Web		PE3C0780	94	1	PE3TC0105-24	213	52	PE4033	Web		PE4158	160	77	PE4284	Web	
PE39419	83	71	PE3C0847	85	11	PE3TC0201	Web		PE4034	Web		PE4159	146	56	PE4285	Web	
PE39420	96	45	PE3C0867	85	99	PE3TC0202	213	56	PE4035	Web		PE4160	147	83	PE4286	Web	
PE39421	Web		PE3C1037	89	70	PE3TC0202-24	213	54	PE4036	140	47	PE4161	Web		PE4288	146	54
PE39422	98	64	PE3C1081	98	67	PE3TC0301	213	59	PE4037	140	48	PE4162	160	80	PE4289	Web	
PE39423	88	90	PE3C1144	101	19	PE3TC0301-24	213	59	PE4038	141	85	PE4163	Web		PE4290	159	74
PE39424	Web		PE3C1349F	82	20	PE3TC0302	Web		PE4039	141	86	PE4164	Web		PE4291	Web	
PE39425	91	38	PE3C1377	77	20	PE3TC0302-24	213	57	PE4040	142	18	PE4165	Web		PE4292	Web	
PE39426	Web		PE3C1400	95	15	PE3TC0303	Web		PE4041	142	19	PE4166	Web		PE4293	160	82
PE39427	Web		PE3C1425	95	33	PE3TC0303-24	213	58	PE4042	133	13	PE4167	Web	70	PE4294	140	19
PE39428	Web		PE3C1528	95	16	PE3TC0401	Web		PE4043	Web		PE4168	Web		PE4295	155	94
PE39429	90	96	PE3C1722	91	40	PE3TC0401-24	213	60	PE4044	123	80	PE4169	Web		PE4296	141	74
PE39430	Web		PE3C1830	87	31	PE3TC0401-24	213	60	PE4045	147	77	PE4170	147	71	PE4297	Web	
PE39431	Web		PE3C1982	84	85	PE3TC0500	Web		PE4046	146	44	PE4171	148	94	PE4298	124	8
PE39432	Web		PE3C1988	100	97	PE3TC0500-24	211	41	PE4047	152	6	PE4172	Web		PE4299	130	55
PE39433	93		PE3C2034	78	53	PE3TC0500-48	211	41	PE4048	133	15	PE4173	160	88	PE4300	Web	
PE39434	96		PE3C2034F	78	54	PE3TC0600	212	42	PE4049	146	64	PE4174	146	64	PE4301	Web	
PE39435	97	62	PE3C2182	78	71	PE3TC0600-24	212	42	PE4051	147	82	PE4175	147	82	PE4302	152	7
PE39436	98	65	PE3C2183F	82	26	PE3TC0600-48	212	42	PE4052	146	55	PE4176	160	85	PE4303	153	21
PE39437	90	92	PE3C2220	79	64	PE3TC0700	Web		PE4053	124	12	PE4177	147	74	PE4304	154	59
PE39438	95	22	PE3C2295	78	50	PE3TC0700-24	212	43	PE4054	153	41	PE4178	148	96	PE4305	154	66
PE39440	92	61	PE3C2295F	78	51	PE3TC0700-48	212	43	PE4055	125	43	PE4179	159	76	PE4306	154	67
PE39441	Web		PE3C2305	96	44	PE3TC0800	76	3	PE4056	125	40	PE4180	160	89	PE4307	124	13
PE39442	Web		PE3C2308	87	41	PE3TC0800-24	212	44	PE4057	142	18	PE4181	131	61	PE4308	Web	
PE39443	Web		PE3C2308F	87	40	PE3TC0800-48	212	44	PE4058	124	20	PE4182	128	7	PE4309	Web	
PE39444	Web		PE3C2404	82	24	PE3TC0800-500CM	212	46	PE4059	135	7	PE4183	128	16	PE4310	Web	
PE39450	Web		PE3C2416	79	57	PE3TC0900	76	6	PE4060	136	50	PE4184	149	49	PE4311	131	68
PE39451	Web		PE3C2416F	79	58	PE3TC0900-24	212	45	PE4061	135	1	PE4186	143	93	PE4312	131	69
PE39452	Web		PE3C2449	94	4	PE3TC0900-48	212	45	PE4062	133	35	PE4187	Web		PE4313	131	71
PE39453	Web		PE3C2679F	88	47	PE3TC1000	Web		PE4063	133	35	PE4188	143	57	PE4314	Web	
PE39454	Web		PE3C3028	89	69	PE3TC1000-24	212	47	PE4064	154	69	PE4189	143	65	PE4315	139	8
PE39455	Web		PE3C3094F	100	99	PE3TC1100	212	47	PE4064SP	154	70	PE4190-SF	142	3	PE4316	Web	
PE39456	Web		PE3C3235	89	85	PE3TC1100-48	Web		PE4065	154	65	PE4190	142	30	PE4317	125	44
PE39457	Web		PE3C3240	84	66	PE3TC1101	Web		PE4066	Web		PE4191	135	93	PE4318	125	38
PE39458</																	

# PART NUMBER INDEX

Note: C/R stands for the Column and/or Row location of the specific product on a given page.

Model No.	Page	C/R	Model No.	Page	C/R	Model No.	Page	C/R	Model No.	Page	C/R	Model No.	Page	C/R	Model No.	Page	C/R	
PE4360	146	63	PE4484	135	77	PE4812	Web		PE4739	Web		PE4872	Web		PE44000	Web		
PE4361	Web		PE4485	Web		PE4813	157	29	PE4740	Web		PE4873	Web		PE44001	Web		
PE4362	Web		PE4486	137	62	PE4814	Web		PE4741	Web		PE4874	Web		PE44002	144	98	
PE4364	147	67	PE4487	136	55	PE4815	157	30	PE4742	Web	145	36	PE4875	145	36	PE44004	144	99
PE4365	Web		PE4488	136	40	PE4816	157	27	PE4743	Web	129	31	PE4876	129	31	PE44005	Web	
PE4366	146	53	PE4489	134	65	PE4817	157	38	PE4744	Web	129	27	PE4877	129	27	PE44007	Web	
PE4367	Web		PE4490	134	66	PE4818	157	34	PE4745	Web	129	27	PE4878	129	27	PE44008	Web	
PE4368	Web		PE4491	134	69	PE4819	157	35	PE4746	Web	129	27	PE4879	129	27	PE44009	Web	
PE4370	Web		PE4492	136	56	PE4820	157	34	PE4747	Web	129	27	PE4880	129	27	PE44010	Web	
PE4371	135	16	PE4493	139	14	PE4821	157	35	PE4748	Web	129	28	PE4881	129	28	PE44011	Web	
PE4372	135	4	PE4494	130	56	PE4822	157	35	PE4749	Web	129	34	PE4882	129	34	PE44012	Web	
PE4373	Web		PE4495	131	70	PE4823	Web		PE4751	Web	129	34	PE4883	129	34	PE44013	Web	
PE4374	126	74	PE4496	139	1	PE4824	157	36	PE4752	Web	129	36	PE4884	129	36	PE44014	Web	
PE4375	126	54	PE4497	139	2	PE4825	Web		PE4755	Web	129	36	PE4885	129	36	PE44015	Web	
PE4376	134	52	PE4498	139	6	PE4826	157	37	PE4756	Web	129	36	PE4886	129	36	PE44016	Web	
PE4377	Web		PE4499	139	13	PE4827	Web		PE4757	126	52	PE4887	130	40	PE44017	144	13	
PE4378	124	83	PE4500	139	14	PE4828	Web		PE4758	Web	132	8	PE4888	132	8	PE44018	Web	
PE4379	124	97	PE4501	139	15	PE4829	Web		PE4759	Web	132	8	PE4889	132	8	PE44019	Web	
PE4380	Web		PE4502	158	64	PE4830	Web		PE4760	Web	130	42	PE4890	130	42	PE44020	Web	
PE4381	123	84	PE4503	159	69	PE4831	Web		PE4761	Web	130	42	PE4891	130	42	PE44021	Web	
PE4382	123	85	PE4504	158	63	PE4832	125	31	PE4762	Web	129	39	PE4892	129	39	PE44022	Web	
PE4383	Web		PE4505	159	67	PE4833	Web		PE4763	Web	129	39	PE4893	129	39	PE44023	Web	
PE4384	124	98	PE4506	159	68	PE4834	Web		PE4764	126	53	PE4894	130	43	PE44024	143	84	
PE4385	Web		PE4507	158	59	PE4835	Web		PE4765	Web	132	8	PE4895	132	8	PE44025	143	85
PE4386	124	99	PE4508	158	59	PE4836	Web		PE4766	Web	144	16	PE4896	144	16	PE44026	Web	
PE4387	124	14	PE4509	158	60	PE4837	Web		PE4767	Web	144	16	PE4897	144	16	PE44027	Web	
PE4388	124	15	PE4510	158	56	PE4838	157	31	PE4768	Web	144	17	PE4898	144	17	PE44028	Web	
PE4389	124	23	PE4511	158	61	PE4839	157	33	PE4769	Web	144	17	PE4899	144	17	PE44029	Web	
PE4391	125	30	PE4512	158	57	PE4840	157	32	PE4770	Web	144	18	PE4900	144	18	PE44030	141	68
PE4392	125	27	PE4513	Web		PE4841	Web		PE4771	Web	144	18	PE4901	144	18	PE44031	Web	
PE4393	124	10	PE4514	Web		PE4842	Web		PE4772	Web	144	18	PE4902	144	18	PE44032	Web	
PE4394	Web		PE4515	158	65	PE4843	124	88	PE4773	Web	144	18	PE4903	144	18	PE44033	Web	
PE4395	Web		PE4516	158	66	PE4844	Web		PE4774	Web	144	18	PE4904	144	18	PE44034	Web	
PE4396	Web		PE4517	126	56	PE4845	Web		PE4775	Web	144	18	PE4905	144	18	PE44035	Web	
PE4397	124	18	PE4518	Web		PE4846	Web		PE4777	Web	144	18	PE4906	144	18	PE44037	Web	
PE4398	140	20	PE4519	Web		PE4847	Web		PE4778	Web	144	20	PE4907	144	20	PE44038	Web	
PE4399	140	42	PE4520	139	92	PE4848	Web		PE4779	Web	144	20	PE4908	144	20	PE44040	Web	
PE4400	140	43	PE4521	Web		PE4849	153	28	PE4780	Web	144	20	PE4909	144	20	PE44042	Web	
PE4401	140	21	PE4522	146	57	PE4850	124	2	PE4782	144	24	PE4910	142	44	PE44043	Web		
PE4402	140	51	PE4523	146	47	PE4851	124	4	PE4783	Web	144	24	PE4911	142	44	PE44044	Web	
PE4403	Web		PE4524	143	63	PE4852	135	10	PE4784	Web	141	63	PE4912	141	63	PE44045	134	42
PE4404	140	52	PE4525	141	62	PE4853	Web		PE4785	144	22	PE4913	141	64	PE44046	134	43	
PE4405	141	76	PE4526	141	97	PE4854	136	34	PE4786	144	25	PE4914	141	64	PE44047	Web		
PE4406	141	88	PE4527	Web		PE4855	136	35	PE4787	Web	141	64	PE4915	141	64	PE44048	147	68
PE4407	141	80	PE4528	143	68	PE4856	158	58	PE4788	Web	141	64	PE4916	141	64	PE44049	139	9
PE4408	141	77	PE4529	143	69	PE4857	130	51	PE4789	Web	141	64	PE4917	141	64	PE44050	155	96
PE4409	141	89	PE4530	143	70	PE4858	Web		PE4790	Web	141	64	PE4918	141	64	PE44051	155	97
PE4410	Web		PE4531	Web		PE4859	Web		PE4791	Web	141	64	PE4919	141	64	PE44052	155	97
PE4411	142	11	PE4532	143	71	PE4860	Web		PE4792	Web	141	64	PE4920	141	64	PE44053	155	95
PE4412	142	1	PE4533	143	96	PE4861	154	75	PE4793	Web	142	27	PE4921	142	27	PE44054	Web	
PE4413	142	2	PE4534	142	31	PE4862	154	79	PE4794	Web	142	28	PE4922	142	28	PE44055	155	1
PE4414	142	3	PE4536	143	72	PE4863	154	76	PE4795	145	28	PE4923	142	28	PE44056	Web		
PE4415	Web		PE4537	Web		PE4864	154	77	PE4796	Web	145	28	PE4924	142	28	PE44057	Web	
PE4416	142	4	PE4538	Web		PE4865	Web		PE4797	Web	145	28	PE4925	142	28	PE44058	Web	
PE4417	Web		PE4539	Web		PE4866	Web		PE4798	146	61	PE4926	146	61	PE44059	156	2	
PE4418	142	22	PE4540	143	97	PE4867	Web		PE4799	Web	146	61	PE4927	146	61	PE44060	Web	
PE4419	142	45	PE4541	141	71	PE4868	154	78	PE4800	Web	146	61	PE4928	146	61	PE44061	Web	
PE4420	142	46	PE4542	142	42	PE4869	Web		PE4801	127	84	PE4929	160	84	PE44062	Web		
PE4421	Web		PE4543	142	43	PE4870	Web		PE4802	Web	142	89	PE4930	142	89	PE44063	Web	
PE4422	Web		PE4544	Web		PE4871	Web		PE4804	Web	142	89	PE4931	142	89	PE44064	Web	
PE4423	Web		PE4545	144	6	PE4872	Web		PE4805	Web	141	96	PE4932	141	96	PE44065	Web	
PE4424	143	53	PE4546	Web		PE4873	Web		PE4806	Web	130	52	PE4933	130	52	PE44066	Web	
PE4425	Web		PE4547	143	76	PE4874	Web		PE4807	Web	135	84	PE4934	135	84	PE44068	136	43
PE4426	Web		PE4548	Web		PE4875	155	84	PE4808	Web	135	84	PE4935	135	84	PE44069	136	44
PE4427	142	47	PE4549	143	73	PE4876	Web		PE4809	127	79	PE4936	135	87	PE44070	Web		
PE4428	Web		PE4550	133	27	PE4877	154	81	PE4810	Web	127	79	PE4937	135	88	PE44071	136	47
PE4429	133	18	PE4551	129	25	PE4878	154	82	PE4811	Web	127	79	PE4938	135	88	PE44072	136	48
PE4430	133	19	PE4552	129	26	PE4879	Web		PE4812	Web	127	79	PE4939	135	88	PE44073	136	49
PE4431	133	20	PE4553	129	32	PE4880	Web		PE4813	Web	127	79	PE4940	135	88	PE44074	Web	
PE4432	133	20	PE4554	129	33	PE4881	154	83	PE4814	Web	127	82	PE4941	136	23	PE44075	Web	
PE4433	134	44	PE4555	129	38	PE4882	Web		PE4815	127	82	PE4942	136	31	PE44076	137	60	
PE4434	134	45	PE4556	130	45	PE4883	Web		PE4816	127	86	PE4943	136	31	PE44077	Web		
PE4435	Web		PE4557	Web		PE4884	Web		PE4817	Web	127	86	PE4944	136	31	PE44078	Web	
PE4436	135	94	PE4558	147	80	PE4885	Web		PE4818	Web	127	86	PE4945	136	31	PE44079	Web	
PE4437	Web		PE4559	129	30	PE4886	155	86	PE4819	Web	127	86	PE4946	136	31	PE44080	139	12
PE4438_DS	Web		PE4560	Web		PE4887	127	87	PE4820	Web	126	63	PE4947	126	63	PE44081	136	40
PE4439	135	6	PE4561	130	41	PE4888	Web		PE4821	Web	126	59	PE4948	126	59	PE44082	Web	
PE4440	136	17	PE4562	Web		PE4889	Web		PE4822	Web	126	60	PE4949	126	60	PE44083	Web	
PE4441	136	27	PE4563	129	19	PE4890	Web		PE4823	Web	126	61	PE4950	126	61	PE44084	Web	
PE4442	136	18	PE4564	129	20	PE4891	Web		PE4824	Web	126	61	PE4951	126	61	PE44085	Web	

# PART NUMBER INDEX

Note: C/R stands for the Column and/or Row location of the specific product on a given page.

Model No.	Page	C/R	Model No.	Page	C/R	Model No.	Page	C/R	Model No.	Page	C/R	Model No.	Page	C/R	Model No.	Page	C/R
PE44131	Web		PE44277	120	89	PE44402	Web		PE44547	Web		PE44666	144	15	PE44886	Web	
PE44132	Web		PE44278	120	90	PE44403	Web		PE44548	Web		PE44667	Web		PE44887	Web	
PE44133	Web		PE44279	120	98	PE44404	Web		PE44549	Web		PE44668	140	25	PE44888	Web	
PE44134	Web		PE44280	120	98	PE44405	Web		PE44550	121	8	PE44669	142	6	PE44890	125	39
PE44135	Web		PE44281	Web		PE44406	Web		PE44551	121	9	PE44670	154	73	PE44891	Web	
PE44136	Web		PE44282	120	99	PE44416	149	48	PE44552	Web		PE44671	Web		PE44892	Web	
PE44137	Web		PE44283	120	5	PE44417	Web		PE44553	Web		PE44672	154	74	PE44893	Web	
PE44138	Web		PE44284	120	3	PE44418	Web		PE44554	Web		PE44673	155	85	PE44894	Web	
PE44139	Web		PE44285	Web		PE44419	Web		PE44555	Web		PE44674	Web		PE44895	Web	
PE44140	Web		PE44286	Web		PE44420	Web		PE44556	Web		PE44675	134	74	PE44896	Web	
PE44141	Web		PE44287	Web		PE44421	Web		PE44557	Web		PE44676	Web		PE44897	Web	
PE44142	147	73	PE44288	120	6	PE44422	Web		PE44558	Web		PE44677	Web		PE44898	Web	
PE44143	148	95	PE44289	Web		PE44424	Web		PE44559	Web		PE44678	Web		PE44899	Web	
PE44145	Web		PE44290	Web		PE44425	Web		PE44562	Web		PE44679	157	26	PE44900	Web	
PE44146	Web		PE44291	121	12	PE44426	150	59	PE44563	Web		PE44680	140	53	PE44901	154	56
PE44147	Web		PE44292	Web		PE44427	Web		PE44564	Web		PE44681	140	61	PE44902	155	87
PE44148	Web		PE44293	152	11	PE44428	Web		PE44565	Web		PE44682	141	90	PE44903	Web	
PE44149	Web		PE44294	123	86	PE44429	150	60	PE44566	Web		PE44683	141	91	PE44906	148	21
PE44161	Web		PE44295	Web		PE44430	Web		PE44567	Web		PE44684	142	23	PE44907	Web	
PE44162	160	90	PE44296	Web		PE44431	Web		PE44568	Web		PE44685	142	24	PE44908	Web	
PE44163	160	93	PE44297	Web		PE44432	Web		PE44569	Web		PE44686	143	59	PE44909	149	22
PE44164	160	91	PE44298	158	49	PE44433	150	66	PE44570	Web		PE44687	129	35	PE44911	149	41
PE44165	160	94	PE44300	Web		PE44434	150	67	PE44571	Web		PE44688	129	33	PE44912	Web	
PE44166	Web		PE44301	Web		PE44435	150	68	PE44572	Web		PE44689	152	93	PE44913	Web	
PE44167	Web		PE44302	Web		PE44436	150	65	PE44573	Web		PE44690	153	27	PE44914	149	42
PE44168	160	92	PE44303	129	37	PE44437	Web		PE44574	Web		PE44701	Web		PE44914	Web	
PE44169	Web		PE44304	Web		PE44438	Web		PE44575	Web		PE44702	135	85	PE44915	149	43
PE44170	Web		PE44305	Web		PE44439	Web		PE44576	Web		PE44703	Web		PE44916	Web	
PE44171	160	95	PE44306	Web		PE44440	Web		PE44577	Web		PE44704	Web		PE44917	Web	
PE44172	160	96	PE44307	Web		PE44441	Web		PE44578	Web		PE44705	135	8	PE44918	149	26
PE44173	161	97	PE44308	Web		PE44442	Web		PE44579	Web		PE44706	136	32	PE44919	Web	
PE44174	Web		PE44309	Web		PE44443	Web		PE44580	Web		PE44707	136	33	PE44920	Web	
PE44175	Web		PE44310	Web		PE44444	Web		PE44581	Web		PE44708	153	27	PE44921	149	27
PE44176	161	98	PE44311	Web		PE44445	Web		PE44582	157	42	PE44709	Web		PE44922	149	28
PE44177	Web		PE44312	Web		PE44446	Web		PE44583	Web		PE44710	Web		PE44923	Web	
PE44178	Web		PE44313	157	40	PE44448	Web		PE44584	Web		PE44711	153	45	PE44924	149	29
PE44180	161	99	PE44314	Web		PE44449	Web		PE44585	Web		PE44712	Web		PE44925	Web	
PE44181	161	1	PE44315	Web		PE44450	Web		PE44586	159	71	PE44713	Web		PE44926	149	30
PE44182	Web		PE44316	Web		PE44451	129	23	PE44587	Web		PE44714	154	64	PE44927	Web	
PE44183	Web		PE44317	157	39	PE44452	Web		PE44588	Web		PE44715	Web		PE44928	Web	
PE44184	Web		PE44318	Web		PE44453	Web		PE44589	158	53	PE44716	121	15	PE44929	Web	
PE44185	145	37	PE44319	157	41	PE44454	133	21	PE44590	Web		PE44717	128	17	PE44930	Web	
PE44186	Web		PE44320	157	44	PE44455	151	75	PE44591	143	67	PE44718	Web		PE44931	149	23
PE44187	Web		PE44321	Web		PE44456	132	89	PE44592	Web		PE44719	Web		PE44932	Web	
PE44188	145	38	PE44322	157	45	PE44457	Web		PE44593	144	10	PE44720	137	58	PE44933	Web	
PE44189	Web		PE44323	Web		PE44458	Web		PE44594	156	4	PE44721	137	59	PE44934	149	31
PE44190	Web		PE44324	157	46	PE44459	Web		PE44595	Web		PE44722	137	59	PE44935	Web	
PE44191	Web		PE44325	157	47	PE44460	Web		PE44596	Web		PE44723	Web		PE44936	148	6
PE44192	145	39	PE44326	157	48	PE44461	Web		PE44597	138	83	PE44724	Web		PE44937	Web	
PE44193	Web		PE44327	Web		PE44470	137	63	PE44598	Web		PE44725	Web		PE44938	Web	
PE44194	Web		PE44328	Web		PE44471	Web		PE44599	Web		PE44726	Web		PE44939	149	37
PE44195	Web		PE44329	Web		PE44472	Web		PE44600	138	85	PE44727	Web		PE44940	Web	
PE44196	145	43	PE44330	Web		PE44473	137	64	PE44601	138	86	PE44728	134	58	PE44941	Web	
PE44197	145	40	PE44331	Web		PE44474	137	65	PE44602	Web		PE44729	135	12	PE44942	Web	
PE44198	145	40	PE44332	Web		PE44475	Web		PE44603	Web		PE44730	152	93	PE44943	Web	
PE44199	Web		PE44333	Web		PE44476	Web		PE44604	Web		PE44731	134	59	PE44944	148	7
PE44200	Web		PE44334	Web		PE44477	Web		PE44605	Web		PE44732	135	13	PE44945	Web	
PE44201	145	41	PE44335	116	10	PE44478	Web		PE44606	138	88	PE44733	120	94	PE44946	148	8
PE44202	145	42	PE44336	Web		PE44479	Web		PE44607	Web		PE44734	Web		PE44947	148	9
PE44203	140	22	PE44337	Web		PE44480	148	99	PE44608	138	89	PE44735	140	54	PE44948	Web	
PE44204	142	33	PE44338	Web		PE44481	148	1	PE44609	Web		PE44736	Web		PE44949	Web	
PE44205	142	35	PE44339	148	2	PE44482	148	2	PE44610	Web		PE44737	Web		PE44950	Web	
PE44206	142	35	PE44340	143	80	PE44483	148	17	PE44611	129	29	PE44738	Web		PE44951	Web	
PE44207	142	36	PE44341	143	88	PE44484	Web		PE44612	142	40	PE44739	Web		PE44952	Web	
PE44208	142	37	PE44342	142	39	PE44485	134	47	PE44613	136	37	PE44740	Web		PE44953	Web	
PE44210	Web		PE44343	143	81	PE44486	209	4	PE44614	Web		PE44741	Web		PE44954	Web	
PE44211	143	60	PE44344	Web		PE44487	118	60	PE44615	Web		PE44742	Web		PE44955	148	10
PE44212	143	61	PE44345	117	19	PE44488	209	2	PE44616	Web		PE44743	Web		PE44956	149	24
PE44213	Web		PE44346	117	19	PE44489	131	72	PE44617	Web		PE44744	Web		PE44957	148	11
PE44214	143	62	PE44347	118	44	PE44490	131	76	PE44618	Web		PE44745	Web		PE44958	Web	
PE44215	117	20	PE44348	148	98	PE44491	131	80	PE44619	Web		PE44746	148	16	PE44959	Web	
PE44216	Web		PE44349	134	46	PE44492	131	81	PE44620	159	70	PE44747	Web		PE44960	Web	
PE44217	117	32	PE44350	135	5	PE44493	131	83	PE44621	Web		PE44748	Web		PE44961	148	18
PE44218	117	33	PE44351	121	18	PE44494	131	84	PE44622	156	16	PE44749	149	32	PE44962	Web	
PE44219	Web		PE44352	121	19	PE44495	138	70	PE44623	Web		PE44750	149	33	PE44963	149	25
PE44220	Web		PE44353	121	18	PE44496	131	72	PE44624	Web		PE44751	133	25	PE44964	Web	
PE44221	Web		PE44354	121	22	PE44497	Web		PE44625	Web		PE44752	Web		PE44965	148	12
PE44222	Web		PE44355	121	23	PE44498	Web		PE44626	Web		PE44753	146	46	PE44966	Web	
PE44223	Web		PE44356	121	24	PE44499	Web		PE44627	Web		PE44754	117	37	PE44967	Web	
PE44225	Web		PE44357	121	29	PE44500	138	81	PE44628	Web		PE44755	117	38	PE44968	131	79
PE44226	117	34	PE44358	Web		PE44501	137	66	PE44629	152	14	PE44756	118	49	PE44969	131	77
PE44227	Web		PE44359	121	27	PE44502	Web		PE44630	153	38	PE44757	Web		PE44970	131	78
PE44228	118	48	PE44360	122	30	PE44503	137	67	PE44631	153	49	PE44758	116	13	PE44971	Web	
PE44229	118	51	PE44361	121	26	PE44504	137	68	PE44632	140	24	PE44759	117	31	PE44972	Web	
PE44230	118	58	PE44362	121	26	PE44											

# PART NUMBER INDEX

Note: C/R stands for the Column and/or Row location of the specific product on a given page.

Model No.	Page	C/R	Model No.	Page	C/R	Model No.	Page	C/R	Model No.	Page	C/R	Model No.	Page	C/R	Model No.	Page	C/R
PE45085	136	57	PE45306	120	83	PE45454	117	23	PE51054	Web	PESSC3025	Web	PEE1108	162	18		
PE45086	158	50	PE45307	128	13	PE45455	117	24	PE51055	Web	PESSC3026	Web	PEE1109	162	20		
PE45114	123	79	PE45310	122	37	PE45456	117	17	PE51056	Web	PESSC3027	Web	PEE1110	162	21		
PE45116	Web		PE45311	122	38	PE45457	117	18	PE51057	Web	PESSC3028	Web	PEE1111	162	22		
PE45117	Web		PE45313	122	39	PE45458	142	8	PE51058	Web	PESSC3029	Web	PEE1112	Web			
PE45119	146	52	PE45314	122	40	PE45459	142	9	PE51059	Web	PESSC3030	Web	PEE1113	162	25		
PE45126	148	19	PE45315	122	33	PE45460	140	36	PE51060	Web	PESSC3033	Web	PEE1114	162	26		
PE45107	140	20	PE45316	122	34	PE45461	142	13	PE51061	Web	PESSC3034	Web	PEE1115	163	27		
PE45128	149	39	PE45317	122	35	PE45462	142	13	PE51062	Web	PESSC3038	Web	PEE1116	162	31		
PE45130	Web		PE45318	122	36	PE45463	142	14	PE51063	Web	PESSC3039	Web	PEE1117	162	32		
PE45131	Web		PE45319	122	56	PE45464	142	15	PE51064	Web	PESTL1000	209	PEE1118	162	33		
PE45132	Web		PE45320	122	57	PE45465	142	16	PE51065	Web	PESTR1000	Web	PEE1119	162	36		
PE45133	136	45	PE45321	123	65	PE45466	142	17	PE51066-2	Web	PESTR1001	Web	PEE1120	162	37		
PE45134	143	52	PE45322	123	68	PE45467	118	51	PE51067	Web	PESTR1002	Web	PEE1121	163	38		
PE45135	140	55	PE45323	123	64	PE45468	118	52	PE51068	Web	PESTR1003	Web	PEE1122	163	40		
PE45136	142	49	PE45324	122	58	PE45469	118	53	PE51069	Web	PESTR1004	Web	PEE1123	163	41		
PE45137	142	7	PE45325	122	59	PE45470	118	54	PE51070	Web	PESTR1005	Web	PEE1124	163	43		
PE45138	Web		PE45326	123	66	PE45471	118	55	PE51071	Web	PESTR1010	Web	PEE1125	163	39		
PE45138	Web		PE45327	123	67	PE45472	117	26	PE51072	Web	PESTR1012	Web	PEE1126	163	42		
PE45140	Web		PE45328	122	60	PE45473	117	27	PE51073	Web	PESTR1013	Web	PEE1127	163	42		
PE45141	143	50	PE45329	123	73	PE45474	117	28	PE51074	Web	PESTR1013	Web	PEE1128	163	54		
PE45142	140	44	PE45330	123	84	PE45475	117	29	PE51075	Web	PE6000-93	Web	PEE1129	163	56		
PE45143	153	50	PE45331	123	75	PE45476	117	28	PE51076	Web	PE6001	203	11	PEE1130	163	58	
PE45145	140	26	PE45332	123	72	PE45477	117	15	PE51077	Web	PE6002	163	61	PEE1131	163	60	
PE45147	Web		PE45333	122	54	PE45478	Web		PE51078	Web	PE6003	203	13	PEE1132	163	62	
PE45150	Web		PE45334	123	70	PE4CO1013	Web		PE51079	Web	PE6006-75	Web	PEE1133	163	66		
PE45153	Web		PE45336	122	31	PE5001	217	6	PE51080	Web	PE6009	204	74	PEE1134	163	65	
PE45154	Web		PE45338	122	32	PE5004-KIT	217	8	PE51081	Web	PE6011-93	Web	PEE1135	163	68		
PE45155	147	79	PE45337	123	61	PE5006	217	5	PE51082	Web	PE6012	163	53	PEE1136	163	67	
PE45156	147	86	PE45338	122	46	PE5007	217	7	PE51083	Web	PE6013	163	15	PEE1137	163	68	
PE45157	Web		PE45339	122	49	PE5008	217	9	PE51084	Web	PE6014	162	16	PEE1138	204	4	
PE45158	Web		PE45340	123	69	PE5009	217	10	PE51085	Web	PE6015	162	17	PEE1139	204	95	
PE45159	Web		PE45341	122	41	PE5010-2	217	12	PE51086	Web	PE6016	162	28	PEE1140	204	15	
PE45160	Web		PE45342	122	42	PE5010-1	217	13	PE51087	Web	PE6017	162	29	PEE1141	204	6	
PE45161	Web		PE45343	122	43	PE5010-3	217	14	PE51088	Web	PE6018	162	30	PEE1142-75	Web		
PE45162	Web		PE45344	122	44	PE5010-5	217	15	PE51106-4	Web	PE6019	162	34	PEE1143	163	48	
PE45163	Web		PE45345	122	46	PE5011-3	216	4	PE51113-4	Web	PE6020	163	47	PEE1144	163	56	
PE45164	Web		PE45346	122	47	PE5011-7	216	4	PE51116	Web	PE6021	163	47	PEE1145	Web		
PE45165	Web		PE45347	122	45	PE5011-6	216	4	PE51117	Web	PE6022	163	57	PEE1146	203	8	
PE45166	Web		PE45348	122	48	PE5011-1	216	4	PE51117A	Web	PE6023	163	45	PEE1147	Web		
PE45167	133	26	PE45349	123	63	PE5011-2	216	4	PE51118	Web	PE6024	162	35	PEE1148	Web		
PE45168	Web		PE45350	122	50	PE5011-5	216	4	PE51119	Web	PE6026	206	94	PEE1149	Web		
PE45169	Web		PE45351	122	51	PE5011-4	216	4	PE51120	Web	PE6027-75	Web	PEE1150	203	30		
PE45170	121	20	PE45352	122	52	PE5011-8	216	4	PE51121	Web	PE6028-75	Web	PEE1151	203	33		
PE45171	Web		PE45353	122	53	PE5011-9	217	11	PE51122	Web	PE6029-75	Web	PEE1152	Web			
PE45172	Web		PE45354	123	71	PE5013	Web		PE51123	Web	PE6030	163	55	PEE1153	Web		
PE45173	Web		PE45355	122	55	PE5014	215	2	PE51124	Web	PE6031	163	59	PEE1154	204	67	
PE45174	Web		PE45358	135	82	PE5019-1	216	3	PE51125	Web	PE6032	204	77	PEE1156	204	66	
PE45176	Web		PE45366	151	81	PE5019-2	216	3	PE51125A	Web	PE6033	206	93	PEE1157	Web		
PE45177	Web		PE45368	151	82	PE5019-3	216	3	PE51126	Web	PE6034	204	7	PEE1158	Web		
PE45180	Web		PE45367	151	78	PE5019-4	216	3	PE51127	Web	PE6035	204	10	PEE1159	Web		
PE45181	Web		PE45369	151	79	PE5019-5	216	3	PE51128	Web	PE6036	204	12	PEE1160	203	49	
PE45182	Web		PE45369	151	80	PE5019-6	216	3	PE51129	Web	PE6037	205	27	PEE1161	203	47	
PE45183	Web		PE45370	152	94	PE5019-7	216	3	PE51130	Web	PE6038	205	30	PEE1162	203	10	
PE45185	Web		PE45371	151	91	PE5019-8	216	3	PE51133	Web	PE6039	205	51	PEE1163	203	9	
PE45186	145	27	PE45372	152	93	PE5019-9	216	3	PE51134	Web	PE6040	205	56	PEE1164	Web		
PE45189	Web		PE45373	151	89	PE5019-10	216	3	PE51135	Web	PE6041	205	71	PEE1165	206	89	
PE45190	Web		PE45374	151	90	PE5019-11	216	3	PE51135A	Web	PE6042	206	77	PEE1166	Web		
PE45193	151	71	PE45375	152	95	PE5019-12	216	3	PE51136	Web	PE6043	206	78	PEE1167	205	73	
PE45194	135	14	PE45381	152	92	PE5019-13	216	3	PE51141	Web	PE6044	Web	PEE1168	205	45		
PE45203	135	14	PE45377	152	2	PE5019-14	216	3	PE51142	Web	PE6045	Web	PEE1169	205	40		
PE45204	141	70	PE45378	152	5	PE5019-16	216	3	PE51143	Web	PE6046	162	19	PEE1172	204	85	
PE45209	151	77	PE45379	151	88	PE5019-17	216	3	PE51144	Web	PE6047	Web	PEE1173	203	20		
PE45210	Web		PE45380	152	97	PE5019-18	216	3	PE51145	Web	PE6048	Web	PEE1174	203	19		
PE45211	Web		PE45381	151	83	PE5019-19	216	3	PE51146	Web	PE6049	Web	PEE1175	203	21		
PE45215	144	1	PE45382	151	84	PE5019-21	Web		PE51147	Web	PE6050	Web	PEE1176	203	21		
PE45216	144	2	PE45383	151	85	PE5019-22	Web		PE51148	Web	PE6051	Web	PEE1177	203	54		
PE45217	Web		PE45384	151	86	PE5201	Web		PE51149	Web	PE6052	Web	PEE1178	203	18		
PE45218	138	82	PE45385	151	87	PE5202	Web		PE51150	Web	PE6053	Web	PEE1179	203	17		
PE45222	138	84	PE45386	152	4	PE5500-KIT	Web		PE51151	Web	PE6054	Web	PEE1180	203	53		
PE45223	138	87	PE45387	152	99	PE5501-6	Web		PE51152	Web	PE6055	Web	PEE1181	203	3		
PE45224	137	69	PE45388	152	1	PE5510	Web		PE51153	Web	PE6056	Web	PEE1182	203	2		
PE45227	156	5	PE45389	152	3	PE5511	Web		PE51154	Web	PE6057	162	13	PEE1183	203	14	
PE45228	156	6	PE45390	152	96	PE5512	Web		PE51155	Web	PE6058	162	14	PEE1184	204	1	
PE45229	156	10	PE45391	152	98	PE5515	Web		PE51156	Web	PE6059	162	24	PEE1185	204	9	
PE45230	156	13	PE45396	Web		PE51000	Web		PE51157	Web	PE6061-93	Web	PEE1186	204	97		
PE45231	156	11	PE45400	118	50	PE51001	Web		PE51158	Web	PE6062-93	Web	PEE1187	204	96		
PE45232	156	12	PE45401	117	25	PE51002	Web		PE51159	Web	PE6063-93	Web	PEE1188	205	44		
PE45233	156	7	PE45402	117	14	PE51003	Web		PE51160	Web	PE6064-75	Web	PEE1189	205	43		
PE45234	156	8	PE45403	116	9	PE51004	Web		PE51161	Web	PE6065-75	Web	PEE1190	204	61		
PE45235	156	9	PE45404	127	89	PE51005	Web		PE51162	Web	PE6066-75	Web	PEE1191	205	39		
PE45237	156	14	PE45404M	127	90	PE51006	Web		PE51163	Web	PE6068	Web	PEE1192	Web			
PE45239	Web		PE45405	150	63	PE51007	Web		PE51164	Web	PE6068	Web	PEE1193	163	51		
PE45248	149	44	PE45406	150	64	PE51008	Web		PE51165	Web	PE6069	203	34	PEE1194	163	49	
PE45249	149	45	PE45410	116	11	PE51009	Web		PE51166	Web	PE6070	203	12	PEE1195	163	50	
PE45250	132	96</															

# 50-OHM CONVERSION TABLE

## (dBm - volts- watts)

dBm	V	Po
+53	100.0	200W
+50	70.7	100W
+49	64.0	80W
+48	58.0	64W
+47	50.0	50W
+46	44.5	40W
+45	40.0	32W
+44	32.5	25W
+43	32.0	20W
+42	28.0	16W
+41	26.2	12.5W
+40	22.5	10W
+39	20.0	8W
+38	18.0	6.4W
+37	16.0	5W
+36	14.1	4W
+35	12.5	3.2W
+34	11.5	2.5W
+33	10.0	2W
+32	9.0	1.6W
+31	8.0	1.25W
+30	7.10	1.0W
+29	6.40	800 mW
+28	5.80	640 mW
+27	5.00	500 mW
+26	4.45	400 mW
+25	4.00	320 mW
+24	3.55	250 mW
+23	3.20	200 mW
+22	2.80	160 mW
+21	2.52	125 mW
+20	2.25	100 mW
+19	2.00	80 mW
+18	1.80	64 mW
+17	1.60	50 mW
+16	1.41	40 mW
+15	1.25	32 mW
+14	1.15	25 mW
+13	1.00	20 mW
+12	0.90	16 mW
+11	0.80	12.5 mW
+10	0.71	10 mW
+9	0.64	8 mW
+8	0.58	6.4 mW
+7	0.50	5 mW
+6	0.45	4 mW
+5	0.40	3.2 mW
+4	0.36	2.5 mW
+3	0.32	2.0 mW

dBm	V	Po
+2	0.28	1.6 mW
+1	0.25	1.25 mW
0	0.23	1.0 mW
-1	0.20	.80 mW
-2	0.18	.64 mW
-3	0.16	.50 mW
-4	0.14	.40 mW
-5	0.13	.32 mW
-6	0.12	.25 mW
-7	0.10	.20 mW
-8	0.09	.16 mW
-9	0.08	.125 mW
-10	0.07	.10 mW
-11	0.06	
-12	0.06	
-13	0.05	
-14	0.05	
-15	0.04	
-16	0.0355	
dBm	mV	Po
-17	31.5	
-18	28.5	
-19	25.1	
-20	22.5	.01 mW
-21	20.0	
-22	17.9	
-23	15.9	
-24	14.1	
-25	12.8	
-26	11.5	
-27	10.0	
-28	8.9	
-29	8.0	
-30	7.1	.001 mW
-31	6.25	
-32	5.8	
-33	5.0	
-34	4.5	
-35	4.0	
-36	3.5	
-37	3.2	
-38	2.85	
-39	2.5	
-40	2.25	.1 µW
-41	2.0	
-42	1.8	
-43	1.6	
-44	1.4	
-45	1.25	

dBm	mV	Po
-46	1.18	
-47	1.0	
-48	0.9	
-49	0.8	
-50	0.71	.01 µW
-51	0.64	
-52	0.57	
-53	0.5	
-54	0.45	
-55	0.4	
-56	0.351	
-57	0.32	
-58	0.286	
-59	0.251	
-60	0.225	.001 µW
-61	0.2	
-62	0.18	
-63	0.16	
-64	0.141	
dBm	µV	Po
-65	128	
-66	115	
-67	100	
-68	90	
-69	80	
-70	71	.1 nW
-71	65	
-72	58	
-73	50	
-74	45	
-75	40	
-76	35	
-77	32	
-78	29	
-79	25	
-80	22.5	.01 nW
-81	20	
-82	18	
-83	16	
-84	11.1	
-85	12.9	
-86	11.5	
-87	10.0	
-88	9.0	
-89	8.0	
-90	7.1	.001 nW
-91	6.1	
-92	5.75	
-93	5.0	

dBm	µV	Po
-94	4.5	
-95	4.0	
-96	3.51	
-97	3.2	
-98	2.9	
-99	2.51	
-100	2.25	.1 pW
-101	2.0	
-102	1.8	
-103	1.6	
-104	1.41	
-105	1.27	
-106	1.18	
dBm	nV	Po
-107	1000	
-108	900	
-109	800	
-110	710	.01 pW
-109	640	
-112	580	
-113	500	
-114	450	
-115	400	
-116	355	
-117	825	
-118	285	
-119	251	
-120	225	.001 pW
-121	200	
-122	180	
-123	160	
-124	141	
-125	128	
-126	117	
-127	100	
-128	90	
-129	80	
-130	71	.1 fW
-131	61	
-132	58	
-133	50	
-134	45	
-135	40	
-136	35	
-137	33	
-138	29	
-139	25	
-140	23	.01 fW



Free Shipping Available  
via UPS Ground to  
USA & Canada



Technical  
Support  
(866) 727-8376



Same-Day Shipping,  
Even Custom  
Cable Assemblies



# RETURN LOSS CONVERSION TABLE

Return Loss (dBm)	VSWR
46.064	1.01
40.086	1.02
36.607	1.03
34.151	1.04
32.256	1.05
30.714	1.06
29.417	1.07
28.299	1.08
27.318	1.09
26.444	1.10
25.658	1.11
24.943	1.12
24.289	1.13
23.686	1.14
23.127	1.15
22.607	1.16
22.120	1.17
21.664	1.18
21.234	1.19
20.828	1.20
20.443	1.21
20.079	1.22
19.732	1.23
19.401	1.24
19.085	1.25
18.783	1.26
18.493	1.27
18.216	1.28
17.949	1.29
17.690	1.30
17.445	1.31
17.207	1.32
16.977	1.33
16.755	1.34
16.540	1.35
16.332	1.36
16.131	1.37
15.936	1.38
15.747	1.39
15.563	1.40
15.385	1.41
15.211	1.42
15.043	1.43
14.879	1.44
14.719	1.45
14.564	1.46
14.412	1.47
14.264	1.48
14.120	1.49
13.979	1.50

Return Loss (dBm)	VSWR
13.842	1.51
13.708	1.52
13.577	1.53
13.449	1.54
13.324	1.55
13.201	1.56
13.081	1.57
12.964	1.58
12.849	1.59
12.736	1.60
12.625	1.61
12.518	1.62
12.412	1.63
12.308	1.64
12.207	1.65
12.107	1.66
12.009	1.67
11.913	1.68
11.818	1.69
11.725	1.70
11.634	1.71
11.545	1.72
11.457	1.73
11.370	1.74
11.285	1.75
11.202	1.76
11.120	1.77
11.039	1.78
10.960	1.79
10.881	1.80
10.804	1.81
10.729	1.82
10.654	1.83
10.581	1.84
10.509	1.85
10.437	1.86
10.367	1.87
10.298	1.88
10.230	1.89
10.163	1.90
10.097	1.91
10.032	1.92
9.968	1.93
9.904	1.94
9.842	1.95
9.780	1.96
9.720	1.97
9.660	1.98
9.601	1.99
9.542	2.00

Return Loss (dBm)	VSWR
9.485	2.01
9.428	2.02
9.372	2.03
9.317	2.04
9.262	2.05
9.208	2.06
9.155	2.07
9.103	2.08
9.051	2.09
8.999	2.10
8.949	2.11
8.899	2.12
8.849	2.13
8.800	2.14
8.752	2.15
8.705	2.16
8.657	2.17
8.611	2.18
8.565	2.19
8.519	2.20
8.474	2.21
8.430	2.22
8.386	2.23
8.342	2.24
8.299	2.25
8.257	2.26
8.215	2.27
8.173	2.28
8.138	2.29
8.091	2.30
8.051	2.31
8.011	2.32
7.972	2.33
7.933	2.34
7.894	2.35
7.856	2.36
7.818	2.37
7.781	2.38
7.744	2.39
7.707	2.40
7.671	2.41
7.635	2.42
7.599	2.43
7.564	2.44
7.529	2.45
7.494	2.46
7.460	2.47
7.426	2.48
7.393	2.49
7.360	2.50

Return Loss (dBm)	VSWR
7.327	2.51
7.294	2.52
7.262	2.53
7.230	2.54
7.198	2.55
7.167	2.56
7.135	2.57
7.105	2.58
7.074	2.59
7.044	2.60
7.014	2.61
6.984	2.62
6.954	2.63
6.925	2.64
6.896	2.65
6.867	2.66
6.839	2.67
6.811	2.68
6.783	2.69
6.755	2.70
6.728	2.71
6.700	2.72
6.673	2.73
6.646	2.74
6.620	2.75
6.594	2.76
6.567	2.77
6.541	2.78
6.516	2.79
6.490	2.80
6.465	2.81
6.440	2.82
6.415	2.83
6.390	2.84
6.366	2.85
6.341	2.86
6.317	2.87
6.293	2.88
6.270	2.89
6.246	2.90
6.223	2.91
6.200	2.92
6.177	2.93
6.154	2.94
6.131	2.95
6.109	2.96
6.086	2.97
6.064	2.98
6.042	2.99
6.021	3.00

Return Loss (dBm)	VSWR
5.999	3.01
5.970	3.02
5.956	3.03
5.935	3.04
5.914	3.05
5.893	3.06
5.872	3.07
5.852	3.08
5.832	3.09
5.811	3.10
5.791	3.11
5.771	3.12
5.751	3.13
5.732	3.14
5.712	3.15
5.693	3.16
5.674	3.17
5.654	3.18
5.635	3.19
5.617	3.20
5.598	3.21
5.579	3.22
5.561	3.23
5.542	3.24
5.524	3.25
5.506	3.26
5.488	3.27
5.470	3.28
5.452	3.29
5.435	3.30
5.417	3.31
5.400	3.32
5.383	3.33
5.365	3.34
5.348	3.35
5.331	3.36
5.315	3.37
5.298	3.38
5.281	3.39
5.265	3.40
5.248	3.41
5.232	3.42
5.216	3.43
5.200	3.44
5.184	3.45
5.168	3.46
5.152	3.47
5.137	3.48
5.121	3.49
5.105	3.50

# MOUNTING HOLES

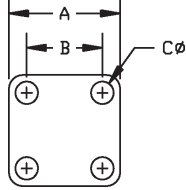

CODE	A	B	C
A01	.500	.340	.102
A02	.687	.500	.109
A03	.687	.500	#3-56 TAP
A04	.687	.500	.125
A05	1.000	.718	.125
A06	.750	.531	.140
A07	.750	.531	.125
A08	1.190	.906	.125
A09	.687	.500	#4-40 TAP
A10	.687	.500	.136
A11	1.250	.975	.147
A12	2.000	1.440	.257
A13	1.000	.718	.141
A14	1.000	.718	.144
A15	.687	.500	.104
A16	.750	.531	.136
A17	.375	.232	.067
A18	.625	.437	.094
A19	1.000	.718	#6-32 TAP
A20	.500	.340	#2-56 TAP
A21	1.250	.975	.142
A22	.375	.232	.093

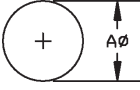

CODE	A
F01	.250
F02	.500
F03	.630
F04	1.200
F05	.380
F06	.450
F07	.200
F08	.362
F09	.220
F10	.317
F11	4.83mm
F12	.390

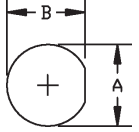

CODE	A	B
B01	.195	.177
B02	.250	.235
B03	.330	.295
B04	.380	.350
B05	.440	.410
B06	.512	.480
B07	.760	.720
B08	.565	.537
B09	.314	.296
B10	.140	.126
B11	.695	.655
B12	.625	.575
B13	.405	.361
B14	.277	.252
B15	.630	.596
B16	.317	.285
B17	.284	.268

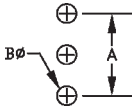

CODE	A	B
J01	.200	.046

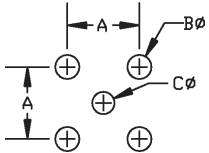

CODE	A	B	C
D01	.200	.067	.062
D02	.200	.067	.046
D03	.100	.031	.031
D04	.200	.052	.052
D05	.260	.067	.043
D06	.200	.052	.047
D07	.200	.055	.043
D08	.200	.067	.035
D09	.200	.055	.028
D10	.200	.055	.035
D11	.320	.091	.031
D12	.400	.062	.062
D13	.320	.091	.091
D14	.340	.091	.043
D15	.164	.067	.091
D16	.500	.126	.440
D17	.380	.083	.043

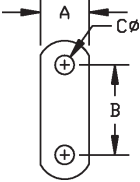

CODE	A	B	C
C01	.223	.481	.102
C02	.260	.481	.102
C03	.192	.328	.067
C04	.640	1.000	.125
C05	.275	.481	.102
C06	.230	.354	.067
C07	.188	.328	.093

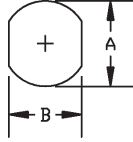

CODE	A	B
G01	.640	.546
G02	.380	.340
G03	.765	.712
G04	.362	.323
G05	.236	.197
G06	.217	.177
G07	.380	.310
G08	1.161	1.000

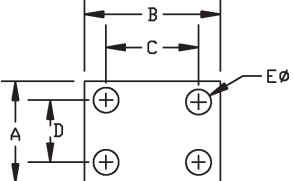

CODE	A	B	C	D	E
E01	.375	.500	.340	.222	.093

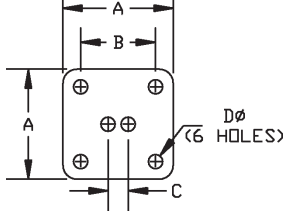

CODE	A	B	C	D
H01	.687	.500	.125	.045



Free Shipping Available  
via UPS Ground to  
USA & Canada



Technical  
Support  
(866) 727-8376



Same-Day Shipping,  
Even Custom  
Cable Assemblies

# CONNECTOR IDENTIFIER

SPECIFICATIONS SHOWN ARE INTENDED FOR IDENTIFICATION PURPOSES ONLY











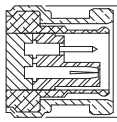
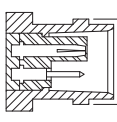
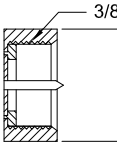
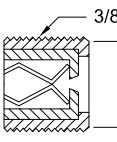
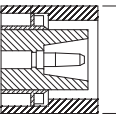
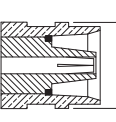
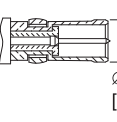
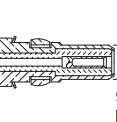
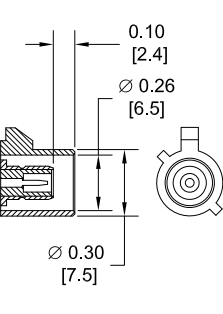
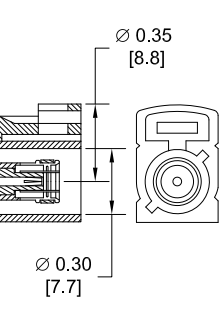







<b>1.0/2.3 SLIDE ON</b>	<b>PLUG</b>		<b>1.0/2.3 SNAP ON</b>	<b>PLUG</b>		<b>1.6/56</b>	<b>PLUG</b>	
	<b>JACK</b>			<b>JACK</b>			<b>JACK</b>	
<b>1.85 mm**</b>	<b>MALE</b>		<b>2.4 mm**</b>	<b>MALE</b>		<b>2.92 mm**</b>	<b>MALE</b>	
	<b>FEMALE</b>			<b>FEMALE</b>			<b>FEMALE</b>	
<b>3.5 mm*</b>	<b>MALE</b>		<b>7 mm</b>	<b>PLUG</b>		<b>7/16</b>	<b>PLUG</b>	
	<b>FEMALE</b>			<b>JACK</b>			<b>JACK</b>	
<b>3/4-20 TWINAX</b>	<b>MALE</b>		<b>10-32</b>	<b>MALE</b>		<b>BANANA</b>	<b>PLUG</b>	
	<b>FEMALE</b>			<b>FEMALE</b>			<b>JACK</b>	
<b>BNC</b>	<b>MALE</b>		<b>REVERSE POLARITY BNC</b>	<b>MALE</b>		<b>75 OHM BNC</b>	<b>MALE</b>	
	<b>FEMALE</b>			<b>FEMALE</b>			<b>FEMALE</b>	

\*SMA, 2.92mm, & 3.5mm CONNECTORS WILL MATE MECHANICALLY & ELECTRICALLY TO EACH OTHER.

\*\*1.85mm & 2.4mm CONNECTORS WILL MATE MECHANICALLY & ELECTRICALLY TO EACH OTHER.

# CONNECTOR IDENTIFIER

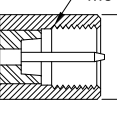
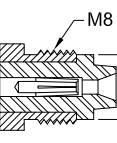
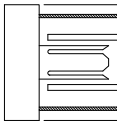
SPECIFICATIONS SHOWN ARE INTENDED FOR IDENTIFICATION PURPOSES ONLY

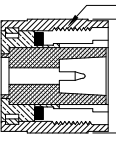
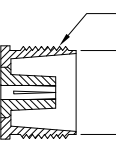
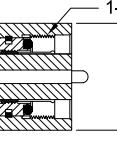
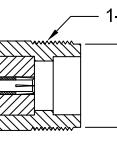
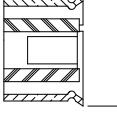
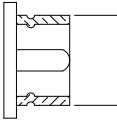
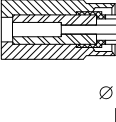
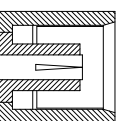
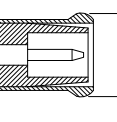
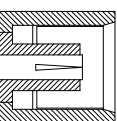
<b>BNC TWINAX</b>	<b>PLUG</b>	 Ø 0.57" [14.5mm]				
	<b>JACK</b>	 Ø 0.44" [11.1mm]				
<b>F</b>	<b>MALE</b>	 3/8-32 7/16 HEX				
	<b>FEMALE</b>	 3/8-32 Ø 0.34 [8.5]				
<b>C</b>	<b>MALE</b>	 Ø 0.75" [19.1mm]				
	<b>FEMALE</b>	 Ø 0.60" [15.2mm]				
<b>D SUBMINIATURE</b>	<b>PLUG</b>	 Ø 0.19" [4.8mm]				
	<b>RECEPTACLE</b>	 Ø 0.15" [3.9mm]				
<b>FAKRA</b>	<b>PLUG</b>	 0.10 [2.4] Ø 0.26 [6.5] Ø 0.30 [7.5]				
	<b>JACK</b>	 Ø 0.35 [8.8] Ø 0.30 [7.7]				
<b>FAKRA</b>	<b>COMPLETE KEY CODE INFO</b>	<b>CODE</b>	<b>JACK</b>	<b>PLUG</b>	<b>COLOR</b>	<b>APPLICATION</b>
		<b>A</b>			BLACK	RADIO WITH PHANTOM SUPPLY
		<b>B</b>			WHITE	RADIO WITHOUT PHANTOM SUPPLY
		<b>C</b>			BLUE	GPS: TELEMATICS OR NAVIGATION
<b>D</b>			BORDEAUX	GSM: CELLULAR PHONE		
<b>H</b>			VIOLET	GPS: TELEMATICS AND NAVIGATION		
<b>I</b>			BEIGE	BLUETOOTH		
<b>K</b>			CURRY	RADIO WITH I.F. OUTPUT (ANTENNA DIVERSITY)		
<b>Z</b>			WATER BLUE	NEUTRAL CODING		
<b>FME</b>	<b>PLUG</b>	 M8 X P.75 Ø 0.37 [9.5]				
	<b>JACK</b>	 M8 X P.75 Ø 0.29 [7.3]				
<b>GR874</b>	<b>PLUG</b>	 Ø 0.81 [20.6]				
	<b>JACK</b>					
<b>HN</b>	<b>MALE</b>	 3/4-20 Ø 0.90 [22.9]				
	<b>FEMALE</b>	 3/4-20 Ø 0.67 [17.1]				
<b>LC</b>	<b>MALE</b>	 1-1/4-18 1-1/2 HEX				
	<b>FEMALE</b>	 1-1/4-18 Ø 1.17 [29.6]				
<b>UMCX</b>	<b>PLUG</b>	 Ø 0.10 [2.5]				
	<b>JACK</b>	 Ø 0.08 [2.0]				
<b>MC-CARD</b>	<b>PLUG</b>	 Ø 0.087 [2.2]				
	<b>JACK</b>	 Ø 0.20 [5.0]				
<b>MCX</b>	<b>PLUG</b>	 Ø 0.15 [3.7]				
	<b>JACK</b>	 Ø 0.20 [5.0]				



# CONNECTOR IDENTIFIER

SPECIFICATIONS SHOWN ARE INTENDED FOR IDENTIFICATION PURPOSES ONLY

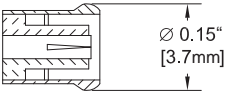
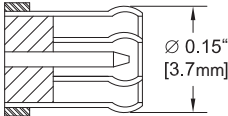
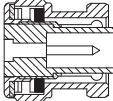
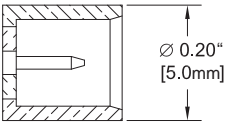
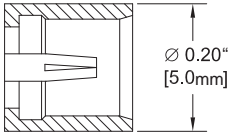
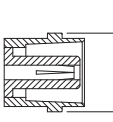
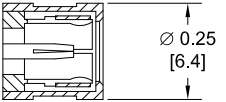
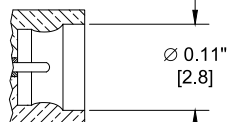
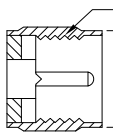
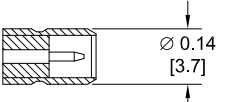
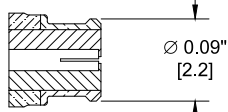
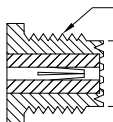
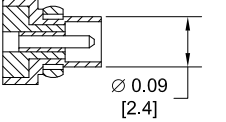
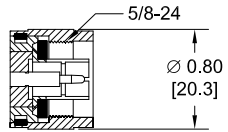
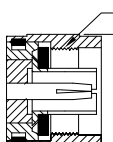
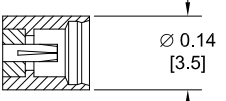
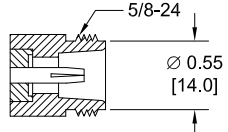
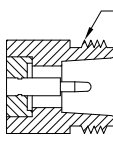
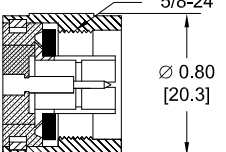
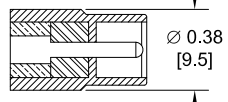
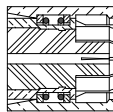
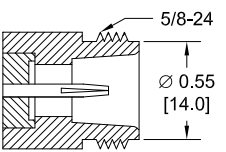
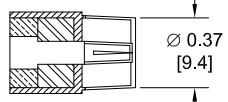
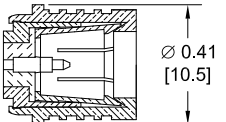
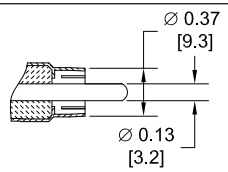
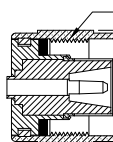
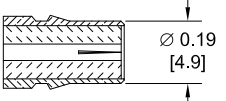
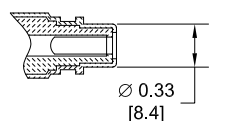
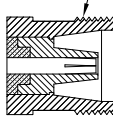
<b>REVERSE POLARITY MCX</b>	<b>PLUG</b>	 Ø 0.15" [3.7mm]	<b>75 OHM MCX</b>	<b>PLUG</b>	 Ø 0.15" [3.7mm]	<b>MHV</b>	<b>MALE</b>	 Ø 0.57" [14.5mm]
	<b>JACK</b>	 Ø 0.20" [5.0mm]		<b>JACK</b>	 Ø 0.20" [5.0mm]		<b>FEMALE</b>	 Ø 0.44" [11.1mm]
<b>MINI 75 OHM SMB</b>	<b>PLUG</b>	 Ø 0.25 [6.4]	<b>MINI SMP</b>	<b>MALE</b>	 Ø 0.11" [2.8]	<b>MINI-UHF</b>	<b>MALE</b>	 3/8-24 Ø 0.45 [11.5]
	<b>JACK</b>	 Ø 0.14 [3.7]		<b>FEMALE</b>	 Ø 0.09" [2.2]		<b>FEMALE</b>	 3/8-24 Ø 0.31 [7.8]
<b>MMCX</b>	<b>PLUG</b>	 Ø 0.09 [2.4]	<b>N</b>	<b>MALE</b>	 5/8-24 Ø 0.80 [20.3]	<b>REVERSE POLARITY N</b>	<b>MALE</b>	 5/8-24 Ø 0.80 [20.3]
	<b>JACK</b>	 Ø 0.14 [3.5]		<b>FEMALE</b>	 5/8-24 Ø 0.55 [14.0]		<b>FEMALE</b>	 5/8-24 Ø 0.55 [14.0]
<b>75 OHM N</b>	<b>MALE</b>	 5/8-24 Ø 0.80 [20.3]	<b>PAL</b>	<b>PLUG</b>	 Ø 0.38 [9.5]	<b>POSITIVE SNAP</b>	 Ø 0.39 [9.9]	
	<b>FEMALE</b>	 5/8-24 Ø 0.55 [14.0]		<b>JACK</b>	 Ø 0.37 [9.4]			
<b>OMA</b>	<b>MALE</b>	 Ø 0.41 [10.5]	<b>RCA</b>	<b>PLUG</b>	 Ø 0.37 [9.3] Ø 0.13 [3.2]	<b>SC</b>	<b>MALE</b>	 11/16-24 Ø 0.80 [20.3]
	<b>FEMALE</b>	 Ø 0.19 [4.9]		<b>JACK</b>	 Ø 0.33 [8.4]		<b>FEMALE</b>	 11/16-24 Ø 0.63 [15.9]

# CONNECTOR IDENTIFIER

SPECIFICATIONS SHOWN ARE INTENDED FOR IDENTIFICATION PURPOSES ONLY

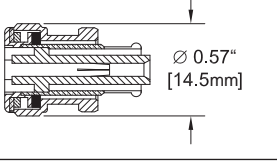
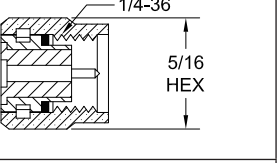
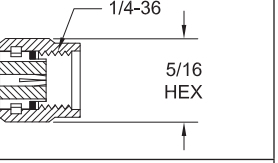
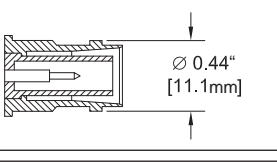
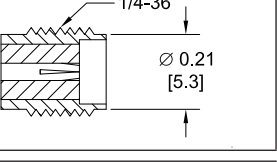
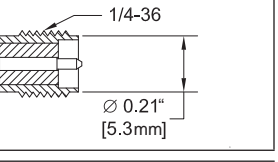
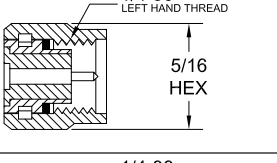
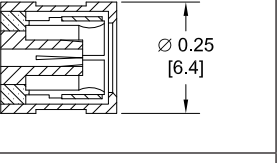
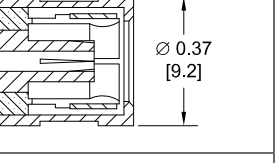
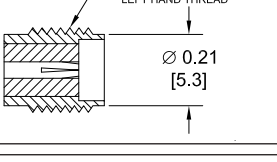
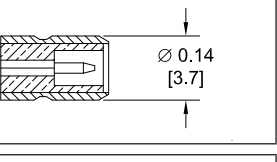
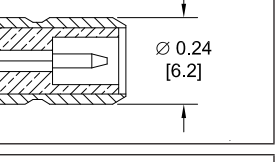
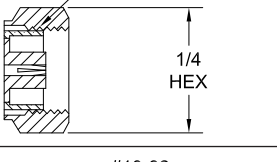
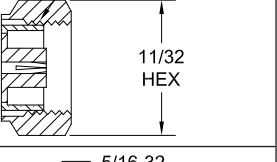
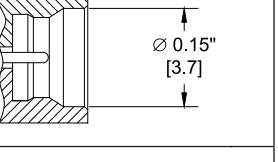
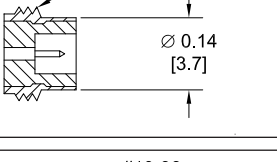
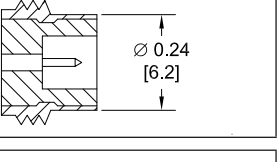
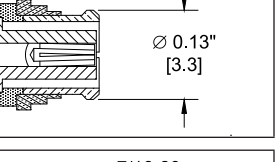
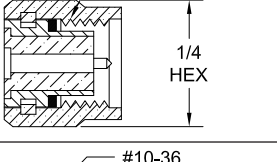
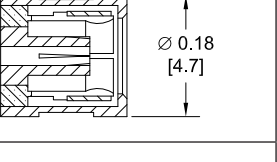
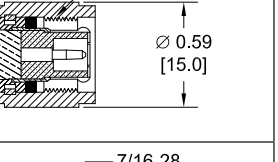
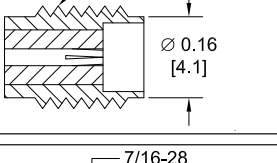
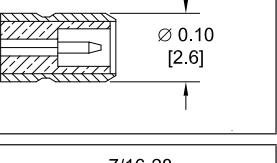
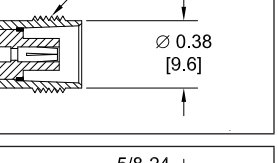
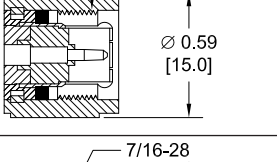
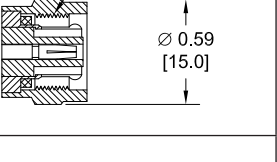
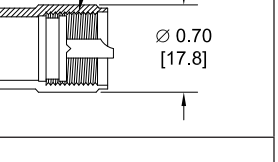
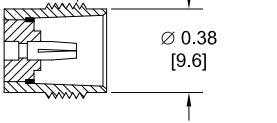
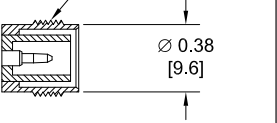
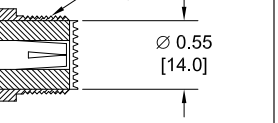
<b>SHV</b>	<b>PLUG</b>	 Ø 0.57" [14.5mm]	<b>SMA*</b>	<b>MALE</b>	 1/4-36 5/16 HEX	<b>REVERSE POLARITY SMA</b>	<b>MALE</b>	 1/4-36 5/16 HEX
	<b>JACK</b>	 Ø 0.44" [11.1mm]		<b>FEMALE</b>	 1/4-36 Ø 0.21 [5.3]		<b>FEMALE</b>	 1/4-36 Ø 0.21" [5.3mm]
<b>SMA REVERSE THREAD</b>	<b>MALE</b>	 1/4-36 LEFT HAND THREAD 5/16 HEX	<b>SMB</b>	<b>PLUG</b>	 Ø 0.25 [6.4]	<b>75 OHM SMB</b>	<b>PLUG</b>	 Ø 0.37 [9.2]
	<b>FEMALE</b>	 1/4-36 LEFT HAND THREAD Ø 0.21 [5.3]		<b>JACK</b>	 Ø 0.14 [3.7]		<b>JACK</b>	 Ø 0.24 [6.2]
<b>SMC</b>	<b>PLUG</b>	 #10-32 1/4 HEX	<b>75 OHM SMC</b>	<b>PLUG</b>	 5/16-32 11/32 HEX	<b>SMP</b>	<b>MALE</b>	 Ø 0.15" [3.7]
	<b>JACK</b>	 #10-32 Ø 0.14 [3.7]		<b>JACK</b>	 5/16-32 Ø 0.24 [6.2]		<b>FEMALE</b>	 Ø 0.13" [3.3]
<b>SSMA</b>	<b>MALE</b>	 #10-36 1/4 HEX	<b>SSMB</b>	<b>PLUG</b>	 Ø 0.18 [4.7]	<b>TNC</b>	<b>MALE</b>	 7/16-28 Ø 0.59 [15.0]
	<b>FEMALE</b>	 #10-36 Ø 0.16 [4.1]		<b>JACK</b>	 Ø 0.10 [2.6]		<b>FEMALE</b>	 7/16-28 Ø 0.38 [9.6]
<b>75 OHM TNC</b>	<b>MALE</b>	 7/16-28 Ø 0.59 [15.0]	<b>REVERSE POLARITY TNC</b>	<b>MALE</b>	 7/16-28 Ø 0.59 [15.0]	<b>UHF</b>	<b>MALE</b>	 5/8-24 Ø 0.70 [17.8]
	<b>FEMALE</b>	 7/16-28 Ø 0.38 [9.6]		<b>FEMALE</b>	 7/16-28 Ø 0.38 [9.6]		<b>FEMALE</b>	 5/8-24 Ø 0.55 [14.0]

\*SMA, 2.92mm & 3.5mm CONNECTORS WILL MATE MECHANICALLY & ELECTRICALLY TO EACH OTHER.



Free Shipping Available  
via UPS Ground to  
USA & Canada



Technical  
Support  
(866) 727-8376



Same-Day Shipping,  
Even Custom  
Cable Assemblies

# CONNECTOR FREQUENCY RANGE CHART

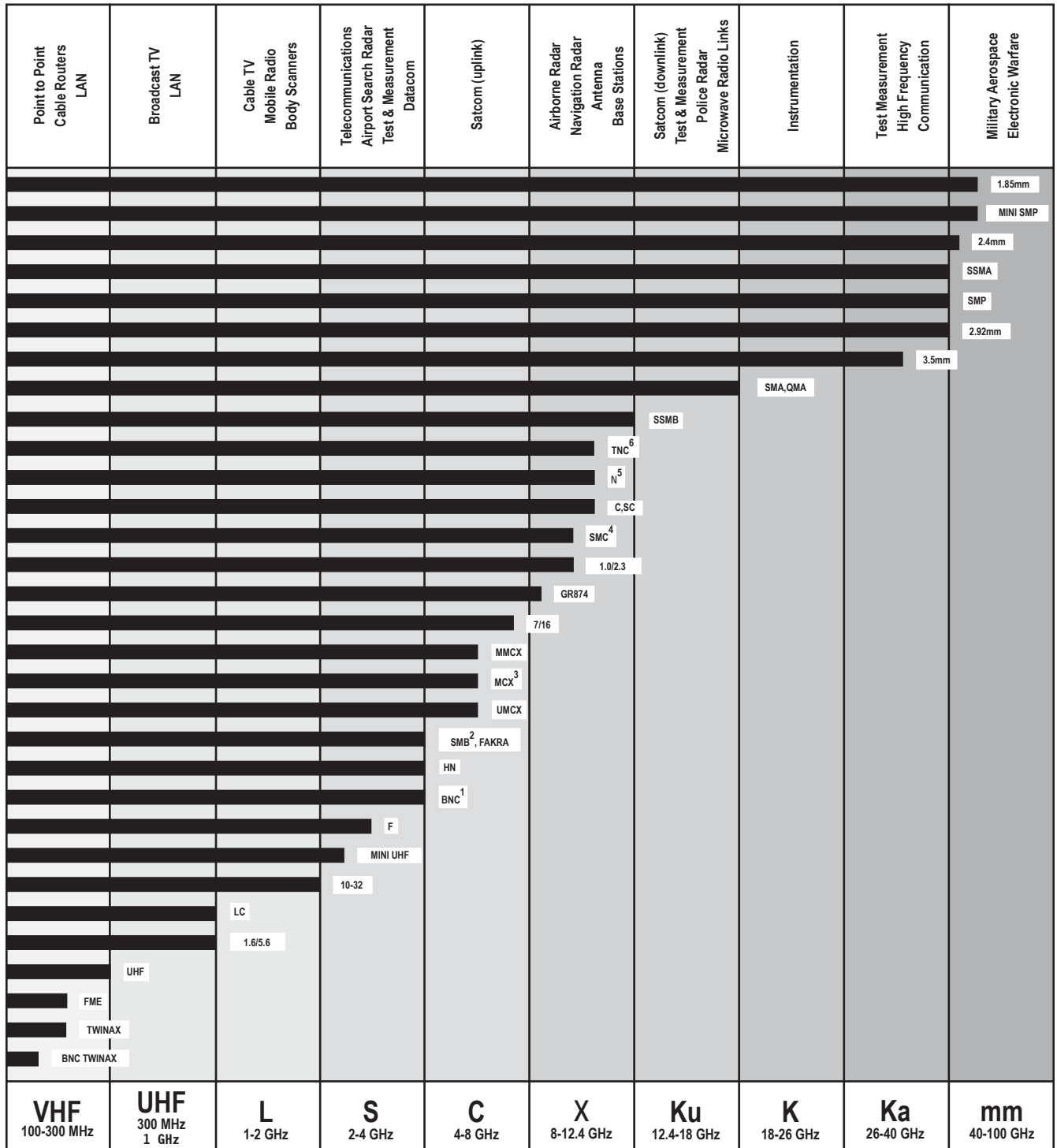

**Notes:**

- 1: BNC-75 Ohm connectors operate up to 1 GHz
- 2: SMB-75 Ohm & Mini SMB-75 Ohm connectors operate up to 4 GHz
- 3: MCX-75 Ohm connectors operate up to 6 GHz
- 4: SMC-75 Ohm connectors operate up to 10 GHz
- 5: N-75 Ohm connectors operate up to 1.5 GHz
- 6: TNC-75 Ohm connectors operate up to 1 GHz



**Australian Representatives**  
**ROJONE, PTY LTD.**  
Tel: 02 9829 1555  
E: sales@rojone.com.au  
www.rojone.com.au