

SMT Power Micro SPDT with 26.5 GHz Capabilities

SURFACE MOUNT TECHNOLOGY



An innovative and original "micro-mechanical" design of the R516 SMT micro-relay offers, excellent RF performance, reliability, and repeatability. The miniature size, and low installation cost make these coaxial switches an ideal solution.

Very low return loss and insertion loss allow this relay to be used in power applications, as well as in typical SMT relay applications such as RF attenuators, RF matrices, spectrum analysers, and telecommunications.

Failsafe models are offered in two RF configurations (direct and inverted). The association of these two products on the same PC board enables the product to perform the bypass function. (For bypass mounting, further information is available on page 2-7).

Actual Size

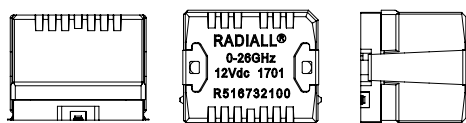

Example of P/N:

R516713100 is a SPDT SMT 26.5 GHz, 24 Vdc, failsafe, not soldered.

Typical Outline Drawing

All dimensions are in millimeters [inches].

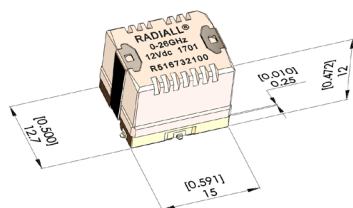

PART NUMBER SELECTION

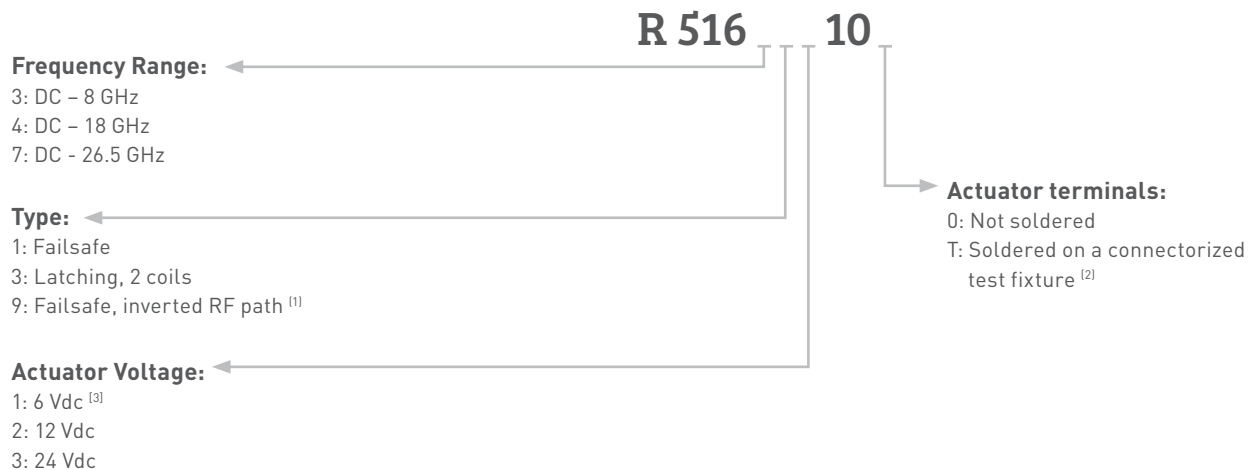

NOTE:

- (1): Can be combined with a failsafe model, so as to achieve the "BYPASS" function (see application details on page 2-6)
- (2): See details about test fixture dimensions on page 2-4
- (3): Only available with type 3

SMT Power Micro SPDT with 26.5 GHz Capabilities

QUARTZ GENERAL SPECIFICATIONS

Operating mode		Failsafe (types 1 and 9)		Latching (type 3)		
Nominal operating voltage (across temperature range)	Vdc	12 (10.5 to 13)	24 (21.5 to 30)	6 (5.1 to 6.6)	12 (10.2 to 13)	24 (20.5 to 30)
Coil resistance at 23°C (+/-10%)	Ω	195	740	55	205	865
Operating current at 23°C	mA	61	32	108	58	32
RF and command ports		Gold plated access, infrared reflow, forced air oven or hand soldering (Compatible with "lead free" soldering processes)				
Switching time at nominal voltage	- Making contacts - Breaking contacts	Max 5 ms (typical 2 ms), including contact bounce time 3 ms				
Life	- Cold switching (max 120 cycles/min) - Hot switching (max 20 cycles/min)	2 million cycles		3 million cycles (5 million cycles typical at low level)		
		500.000 cycles				
Insulation	Dielectric test voltage		300 Vrms			
	Insulation resistance at 500 Vdc		> 100 MOhms			
Environmental protection		Lead free construction - Waterproof (acc. To IEC 60529 / IP64)				
Mass		8 g				
Operating temperature range (with no icing nor condensation)	°C	-25 to +70 ⁽¹⁾		-40 to +85		
Storage temperature range	°C	- 55 to +85				
Sine vibration (MIL STD 202, Method 204D)		Condition D: 10-2000 Hz, 20 g		Operating		
		Condition G: 10-2000 Hz, 30 g		Non-operating		
Shocks (According to MIL STD 202, Method 213B, Cond. C)		100g / 6 ms, 1/2 sine		Operating		

(1): Failsafe models may be used down to -40°C, for this application please follow requirements of AN-R516-51. Contact Radiall for a copy of this application note.

PIN IDENTIFICATION (TOP VIEW)

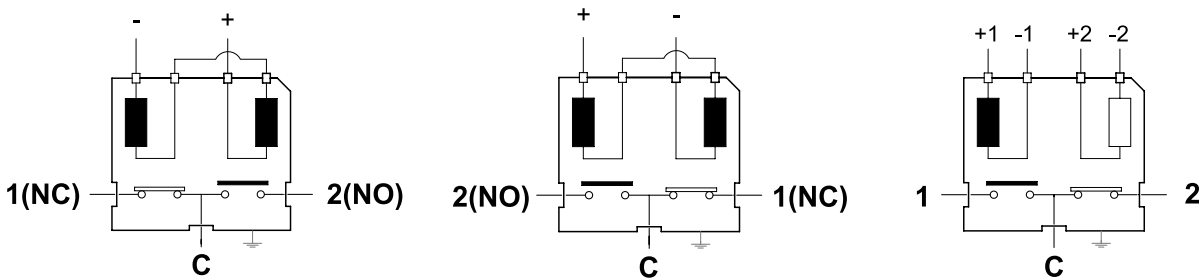

Failsafe model (Type 1)

Voltage	RF continuity
De-energized	C <--> 1(NC)
Energized	C <--> 2(NO)

Inverted failsafe model for Bypass application (Type 9)

Voltage	RF continuity
De-energized	C <--> 1(NC)
Energized	C <--> 2(NO)

Latching model (Type 3)

Voltage	RF continuity
-1 +1	C <--> 1
-2 +2	C <--> 2

SMT Power Micro SPDT with 26.5 GHz Capabilities

QUARTZ PERFORMANCE (S PARAMETERS AVAILABLE ON REQUEST)

Frequency range GHz	V.S.W.R. (max)	Insertion loss (max) dB	Isolation (min) dB		Third order Inter modulation	Impedance Ω
			switch alone			
DC - 8	DC - 3	1.20	0.20	50	-110 dBc typical at 1730 MHz (2 carriers 20 W)	50
	3 - 6	1.35	0.40	40		
DC - 18	6 - 8	1.40	0.50	40		
	8 - 12.4	1.50	0.60	40		
DC - 26.5	12.4 - 18	1.70	1.00	40		
	18 - 26.5	2.00	1.60	40		

MEASUREMENT METHOD

Relay soldered on test fixture ⁽⁷⁾

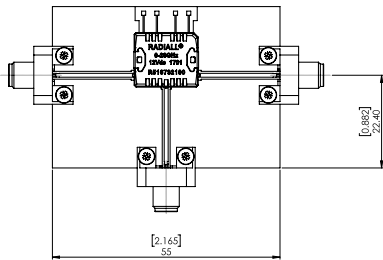

Calibration board

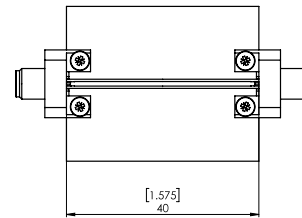

All dimensions are in millimeters [inches].

Inputs/Outputs of the calibration board and test fixture are equipped with coaxial type receptacle connectors. The length of the RF tracks is the same on the calibration board and the test fixture circuits. The insertion loss of the relay itself is calculated by subtracting the insertion loss of the “calibration board” to the insertion loss of the “relay soldered on the test fixture.”

(7): Relay soldered on Test Fixture is available. To order, please use the suffix "T" (part number R516 - - - - T), as explained in page 2-2.

TYPICAL RF PERFORMANCE

Insertion Loss and Isolation

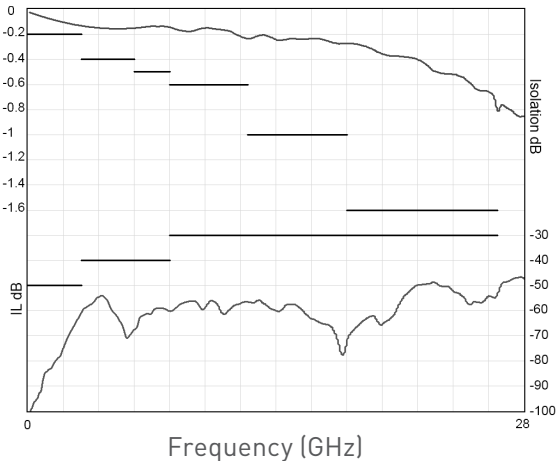

V.S.W.R

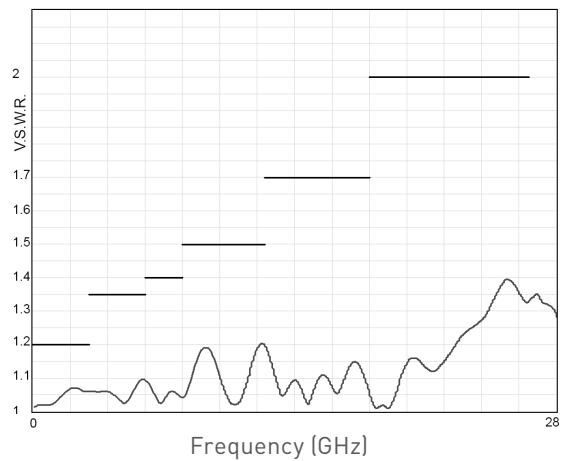

SMT Power Micro SPDT with 26.5 GHz Capabilities

RF POWER RATING FOR COLD SWITCHING USE

(Impedance 50 Ohms, V.S.W.R. < 1.25)

Power level depends on environmental conditions:

- R516 series have been designed to be used without a cooling fan even for high power applications. However, the power capability may be still improved by using the appropriate cooling fan.
- For failsafe models used with coil permanently supplied (N/O position), the same power level as latching models may be applied.

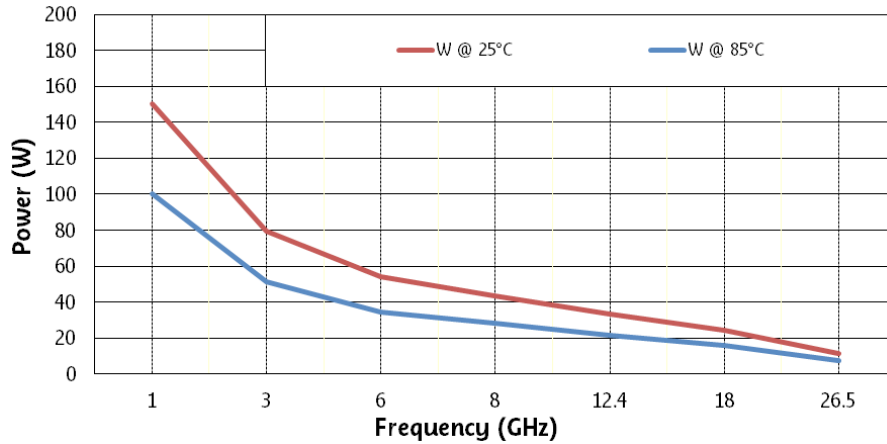

RELAY PACKAGING

According to IEC 286-3 standard

Materials:

- Reel: polyester
- Carrier tape: PVC
- Cover tape: polyester

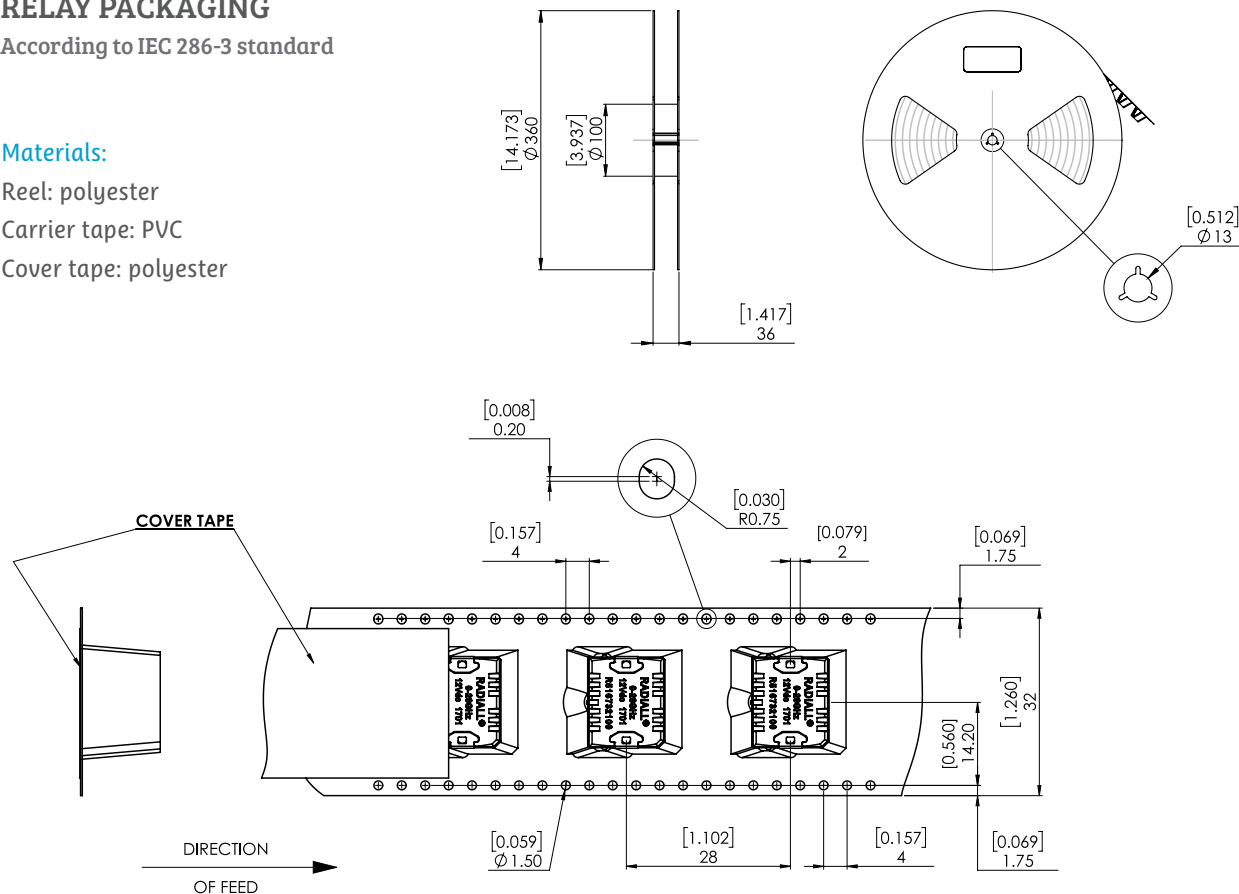

SIMPLIFICATION *is our* INNOVATION

SMT Power Micro SPDT with 26.5 GHz Capabilities

Video shadow of the relay

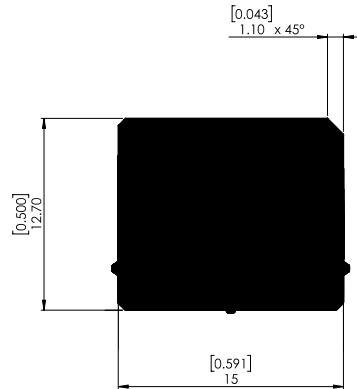

Aspiration area

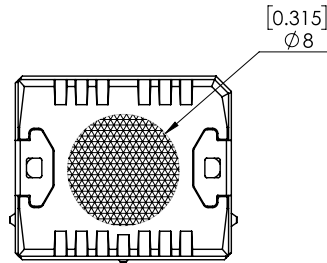

All dimensions are in millimeters [inches].

BYPASS APPLICATION

Failsafe Micro-relay typical implantation

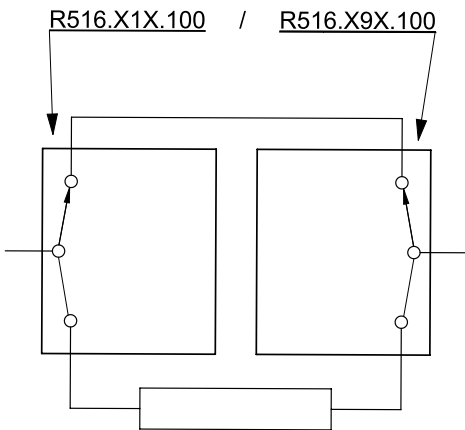

SPDT relays (Single Pole Double Throw) can be used to achieve a bypass switch function. For SMT applications, R516 series, relays are available in two failsafe versions, standard and inverted, to provide symmetric RF ports implantation possibility. The “side by side” implementation of these two versions on a PCB effectively produces the bypass function. The package size is reduced and interconnecting tracks are shortened. Required in order to protect the receiver for transmit/receive applications. RF performance of bypass switch assemblies depend on the distance between the two RF SMT relays.

SMT Power Micro SPDT with 26.5 GHz Capabilities

PC BOARD MOUNTING

Board layout

DXF or Gerber format file available upon request.

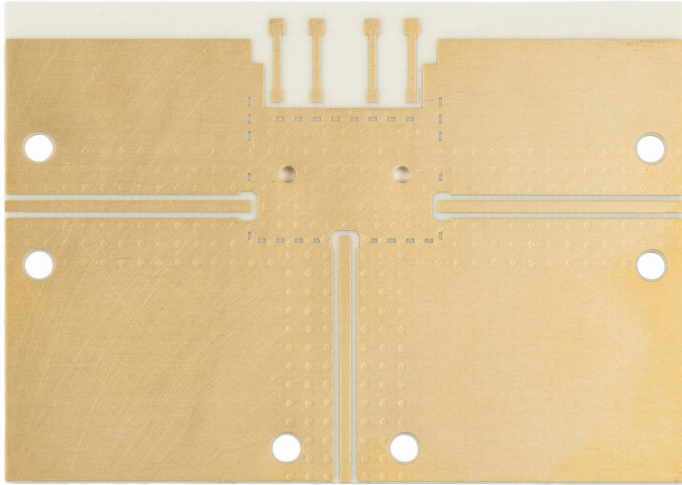

Substrate types

Recommended substrates are ROGERS RO4003.,
Thickness 0.508 mm Cu double side 17.5 μm .

**Recommended total thickness of RF tracks (copper over
thickness + plating): 40 μm .**
Other substrates may be used.

Please contact your local sales representative for additional information.

SMT Power Micro SPDT with 26.5 GHz Capabilities**RECOMMENDED SOLDERING PROCEDURE****A - Soldering procedure using automatic pick and place equipment****1 - Solder paste:**

R516 series are "Lead Free", and Lead Free Sn-Ag3.5-Cu0.7 solder cream may be used as well as standard Sn63-Pb35-Ag2. RADIALL recommends using a "no clean - low residue" solder cream (5% solid residue of flux quantity) that will permit the elimination of the cleaning operation step after soldering.

Note: Due to the gold plating of the switch PCB interface, it is important to use a paste made with silver. This will help in avoiding formation of intermetallics as part of the solder joint.

2 - Solder paste deposition:

Solder cream may be applied on the board with screen printing or dispenser technologies. For either method, the solder paste must be coated to appropriate thickness and shapes to achieve good solder wetting. Please optically verify that the edges of the zone are clean and without contaminates, and that the PCB zoned areas have not oxydated. The design of the mounting pads and the stenciling area are available upon request, for a thickness of the silk-screen printing of 0.15 mm (0.006").

3 - Placement of the component:

For small lightweight components such as chip components, a self-alignment effect can be expected if small placement errors exist. However, this effect is not as expected for relays components and they require a accurate positioning on their soldering pads, typically +/- 0.1 mm (+/-0.004"). Place the relay onto the PCB with automatic pick and place equipment. Various types of suction can be used. Radiall does not recommend using adhesive agents on the component or on the PCB.

4 - Soldering: infra-red process:

Please follow the Radiall recommended max temperature profile for infra-red reflow or forced air convection:

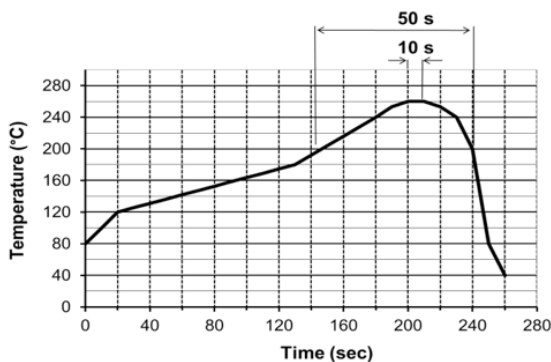

Higher temperature (>260°C) and longer process duration would permanently damage the switches.

5 - Cleaning procedure:

On miniature relays, high frequency cleaning may cause the contacts to stick. If cleaning is needed, please avoid ultrasonic cleaning and use alcohol based cleaning solutions.



In-line cleaning process, spraying, immersion, especially under temperature, may cause a risk of degradation of internal contacts. For such cleaning process please contact us.

6 - Quality check:

Verify by visual inspection that the component is centred on the mounting pads. Solder joints: verify by visual inspection that the formation of meniscus on the pads are proper.

B - Soldering procedure by manual operation

Manual soldering is not recommended for high frequencies, as it generates resonance and lower RF characteristics due to gaps between PC board and relay grounds.

1 - Solder paste and flux deposition:

Refer to procedure A - 1. Deposit a thin layer of flux on solder pad area. Allow the flux to evaporate a few seconds before applying the solder paste, it will prevent dilution of the paste.

2 - Solder paste deposition:

Radiall recommends depositing a small amount of solder paste on solder pad area by syringe, according to the manual soldering pattern (available upon request). Be careful, not to apply solder paste outside of the zone area.

3 - Placement of the component:

During manipulation, avoid contaminating gold surfaces by contact with fingers. Place the component on the mounting zone by pressing on the top of the relay lid.

4 - Hand soldering:

Iron wattage 30 to 60 W. To keep better RF characteristics, apply pressure on the relay lid during all the soldering stage, so as to reduce the air gap between the PC board and the relay. If possible, fix the ground plane of the relay on the board with two M1.2 screws before the soldering stage. On each side of the central RF access, the RF body edge must be soldered to the ground of the PC board. To improve RF characteristics and avoid soldering the RF body to the ground, a conductive gasket may be used (please contact us for detailed application note).

5 - Cleaning procedure:

Refer to procedure A - 5.

6 - Quality check:

Verify by visual inspection that component is centred on the mounting pads. Solder joints: verify by visual inspection that there is no solder excess on the RF pads.

Applications

PC BOARD MOUNTING

The SMT Series offers a large range of products which can be used in many applications such as:

- Tower mount amplifiers
- Instrumentation
- Military radios
- ECM equipment
- Remote Radio Unit (RRU)
- Radio-Links
- Repeaters

These products offer the same RF Board and soldering process as all RF components but with a reduced weight and size. They are designed to meet all market specifications.

